



TIGER FAMILY



DI-50EB51 & DI-50TB51

Programmable Meter Controllers

Tiger 320 Series PMCs

51 Segment Bargraph, 5 Digit 0.31" LEDs
in a 1/8 DIN Case

A powerful, intelligent, 5-digit, 51-segment Programmable Meter Controller (PMC) with modular outputs, input signal conditioning and advanced software features for monitoring, measurement, control and communication applications.

General Features

- The Tiger 320 Operating System supports an easy to use PC based Configuration Utility Program (which can be downloaded FREE from the Texmate website) and programming from front panel buttons.
- The T Version supports custom macro programs that can be easily produced with the Tiger 320 Macro Development System (available FREE on the Texmate website). The Development System enables programs to be written in BASIC, which can utilize any combination of the hundreds of functions and thousands of registers embedded in the Tiger 320 Operating System.
- Red or green 7-segment, 0.31" high LEDs with full support for seven segment alphanumeric text.
- Brightness control of LED display from front panel buttons.
- 51 segment red or green bargraph that can display the signal from any of four channels or the result of a processed input signal.
- Modular construction with more than 120 interchangeable input signal conditioners and more than 25 interchangeable I/O modules.
- Up to 4 input channels with cross channel math for multi-channel processing.
- For applications where sensor excitation is required, modules are provided with 5V, 10V or 24 V DC voltage outputs.
- On demand tare, calibration and compensation can be initiated by the front panel program button.
- Autozero maintenance for super stable zero reading is provided for use in weighing applications.
- Programmable input averaging and smart digital filtering for quick response to input signal changes.
- Display text editing. Customize display text for OEM applications.
- Scrolling display text messaging on T meters with macros.
- Auto-sensing high voltage or optional low voltage AC / DC power supply.
- Serial output options include RS-232, RS-485, ModBus, Ethernet, or direct meter-to-meter communications.
- Single or dual 16-bit Isolated Analog Outputs. Programmable 0~4 to 20mA or 0 to 10V for retransmission, 4-20mA loops to drive valve actuators, remote controllers & displays, multi-loop feedback and PID output. Scalable from 1 count to full scale.
- Dual independent totalizers to integrate input signals.
- 6 super smart, independently programmable setpoints with 8 selectable functions, including latching, deviation, hysteresis, register resetting, tracking and dual PID. Plus 7 programmable timer modes on all 6 setpoints.
- Setpoint tracking, setpoint latching and manual relay reset.
- Setpoints activated from any input, any register in the meter or from any digital input.
- Plug-in I/O modules include electromechanical or solid state relays, logic outputs or open collector outputs. 6 inputs & 16 outputs of opto-isolated I/O can be connected to an external DIN Rail terminal block module.
- Internal program safety lockout switch to prevent tampering.
- Peak & valley (max & min) with front panel recall and reset.
- Real time clock with 15 year Lithium battery backup.
- Data logging within the meter (up to 4000 samples with date/time stamp).
- Optional NEMA-4 front cover.
- UL Listed

Input Module Compatibility

TIGER FAMILY: More than 120 different Plug-in I-Series Input Signal Conditioners are approved for the Tiger Family of meters.

See *I-Series Input Signal Conditioning Modules Guide* (Z87) for an up-to-date list.



Table of Contents

General Features	1	Programming Procedures	17-33	Index	46-47
Specifications	2-3	Setpoint Programming Mode	34-39	Case Dimensions	48
Block Diagram of Tiger 320 Structure ...	4	Registers	40		
Controls & Indicators	6-7	Functional Diagram	41		
Front Panel Configuration & Setup	8	Connector Pinouts	41		
Front Panel Programming Codes	9-10	Carrier Board Output Pins	42		
Initial Setup Procedures	11-12	Relay and Logic I/O Modules	42		
Display Brightness	12	Component Layout & Ext. Devices ...	43-44		
Calibration Modes	13-16	Installation Guidelines	45		

Display

Digital Display: 7-segment, 0.31" (8 mm) LEDs.

Display Color: Red (std). Green (optional).

Digital Display Range: -19999 to 99999

Update Rate: 3 to 10 times per second

Bargraph Display: 51-segment bargraph.

Bargraph Color: Red (std). Green (optional).

Display Dimming: 8 brightness levels. Front Panel selectable

Scrolling Display Text Messaging: Full alphanumeric, 7-segment text characters supported on T Version with macros.

Polarity: Assumed positive. Displays - negative

Decimal Point: Front panel, user selectable to five positions.

Overrange Indication: 

Underrange Indication: 

Front Panel Controls: PROGRAM, UP and DOWN.

Operating System (Tiger 320)

Processor: 32 bit with floating point maths (18.4 MHz)

Flash Memory: 64k, 4k for use by custom macros.

RAM: 1.25k and FeRAM 4k.

EEPROM: E Version 4k standard, T Version 32k standard. Memory upgrades available to 32k for LIN Tables and 1MB for Data Logging and custom macros.

Registers: 6144 registers comprised of 8, 16 or 32 bit signed, unsigned or floating point registers, implemented in a combination of RAM, FeRAM, Flash and EEPROM.

Internal communication BUS: 32 bit I²C BUS

Real Time Clock (option): Year:Month:Date:Hour:Minute:Second with 15 yr Lithium battery backup.

Configuration: Supports Front Panel Programming Codes and a PC-based Configuration Utility Program, which may be downloaded free from our website. T Version also supports custom macros.

Development System for Custom Macros

The Tiger 320 Macro Development System, which may be downloaded free from our website, can be used to create powerful macro software that allows Tiger 320 T Versions to be easily customized to suit any proprietary OEM application.

Installed Application Software Includes

Counter Functions: Two built-in counters. UP counters, DOWN counters, UP/DOWN counters and high speed quadrature counters.

Data Logging: Logging with a date/time stamp, initiated at timed intervals, by activation of a setpoint, or manually. Data stored in internal 1MB EEPROM or in a removable 4 to 128M Flash Card Memory Module. Endless loop recording is supported.

Input Compensation: Provides compensation to the primary input channel (CH1) via channels 2, 3 or 4.

Linearization: 4 selectable 32 point or one 125 point flexible linearization tables are provided.

Logic I/O: 28 Macro programmable I/O ports supported.

Manual Loader: Front panel adjustable, 4 to 20mA or 0 to 10V isolated analog output.

Math Functions: Cross channel math functions to calculate the sum, difference, ratio or the product of two inputs.

On Demand Functions: Tare, compensation and calibration.

Peak and Valley: The meter can retain peak and valley (min/max) information and recall this on the front panel.

Remote Setpoint Input: Remote setpoint input via channel 2.

Serial Output Protocols: Selectable communication modes include ASCII, Modbus (RTU), Master Mode (for meter to meter communication) and an Epson compatible printer driver. An Ethernet optional output carrier board is also supported.

Setpoint Functions: Six super smart setpoints with fully configurable hysteresis, on and off delays, one shot, pulse and repeat timers, latching, dual PID, setpoint tracking, resetting of registers, initiating of logging and printing.

Signal Conditioning Functions: Averaging, smart filter, rounding, square root, auto zero maintenance.

Timer: Timer functions supported in either time-up, time-down, or real-time clock modes.

Totalizer: Two totalizers for running total and batch totals of a process signal that can be accumulated over time.

Inputs

Inputs Available: More than 120 single, dual, triple and quad input signal conditioners available covering all types of analog, digital and mixed input signals.

Accuracy: Tiger 320 PMCs enable the user to establish any degree of system accuracy required. Built-in compensation and linearization functions enable system accuracies of the order of $\pm 0.0001\%$ of reading for analog inputs. Stop -Start time resolution from ± 1 sec to ± 0.7 nsec. Digital input and pulse counts ± 1 count.

A/D Convertors: A Dual Slope, bipolar 17 bit A/D is provided as standard on the main board. SMART modules can have 24 bit or 16 bit Delta-Sigma A/D convertors that utilize the internal I²C BUS.

Temperature Coefficient: Typically 30ppm/°C. Compensation can be utilized to achieve system temperature coefficients of 1ppm.

Warm Up Time: Up to 10 minutes, depending on input module.

Conversion Rate: Typically 10 samples per second. However, SMART input modules are available that can convert at 60, 240, 480 or 960 samples per second.

Control Output Rate: Can be selected for 100msec or 10msec. Some SMART modules have SSR outputs that react within 1.2msec.

Excitation Voltage: Depends on input module selected. Typically, 5V, 10V or 24VDC is provided.

Outputs

(See pages 42-43 for pinouts and details of modular construction)

Two Optional Plug-in Carrier Boards: Provide three different serial outputs or no serial output, support single or dual analog outputs, and accept any one of seven different plug-in I/O modules.

- 1. Standard Carrier Board:** Is available without a serial output, or with either an isolated RS-232 or an isolated RS-485 (RJ-6 socket).
- 2. Ethernet Carrier Board:** 10/100Base-T Ethernet (RJ-45 socket).

Two Isolated Analog Output Options: Mounted on any carrier board.

- 1. Single Analog Output:** Fully scalable from 4 to 20mA or 0 to 20mA (or reverse) and selectable for 0 to 10VDC (or reverse).
- 2. Dual Analog Output:** Fully scalable from 0 to 10VDC (or reverse).

Outputs continued

Analog Output Specifications: Accuracy: 0.02% FS. Resolution: 16-bit Delta-Sigma D/A provides 0.4 μ A on current scaling, 250 μ V on voltage scaling. Compliance: 500 Ω maximum for current output. 500 Ω minimum for voltage output. Update Rate: Typical 7 per second. Step Response: Typical 6msec to a display change. Scalable: From 1 count to full scale.

Seven I/O Modules: Plug into any carrier board from rear.

- 1. Four Relay Module:** Available in six combinations from one relay up to a total of two 9/10A Form C Relays* and two 4/5A Form A Relays**.
- 2. Four Relay Module:** Available with one to four 5A Form A Relays**.
- 3. Six Relay Module:** Available with five or six 4A Form A Relays**.
 - ***Form C Relay Specifications:** 9/10A 240VAC~1/2 HP, 8A 24VDC. Isolation 3000V. UL and CSA listed.
 - ****Form A Relay Specifications:** 4/5A 240VAC, 4A 24VDC. Isolation 3000V. UL and CSA listed.
- 4. Four Solid State Relay (SSR) Module:** Available with one to four independent (210mA DC only) SSRs (300V max).
- 5. Six Output 5VDC / TTL or Open Collector:** Available with 0 to 5VDC (50 mA) or 0 to V+ (50VDC max, 100 mA).
- 6. Opto Isolated I/O Module:** Available in either 6 Outputs & 6 Inputs, or 16 Outputs and 6 Inputs. For connection to an external breakout box.
- 7. Flash Card Memory Module:** Available with 8 or 16 MB memory.

Power Supplies

Auto sensing AC/DC (DC to 400Hz) hi volts std, low volts optional.

PS1 (standard): 85-265VAC / 95-300VDC @ 2W nominal.

PS2 (optional): 14-48VAC / 10-72 VDC @ 2W nominal.

Environmental (See Rear page for IP-65 & NEMA-4 options)

Operating Temperature: 0 to 50 °C (32 °F to 122 °F).

Storage Temperature: -20 °C to 70 °C (-4 °F to 158 °F).

Relative Humidity: 95% (non-condensing) at 40 °C (104 °F).

Mechanical (See Rear page for more details)

Case Dimensions: 1/8 DIN, 96x48mm (3.78" x 1.89")

Case Material: 94V-0 UL rated self-extinguishing polycarbonate.

Weight: 11.5 oz (0.79 lbs), 14 oz (0.96 lbs) when packed.

Approvals

CE: As per EN-61000-3/4/6 and EN-61010-1.

UL: E469078

Block Diagram of the Tiger 320 Software and Hardware Structure

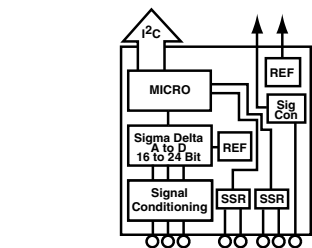
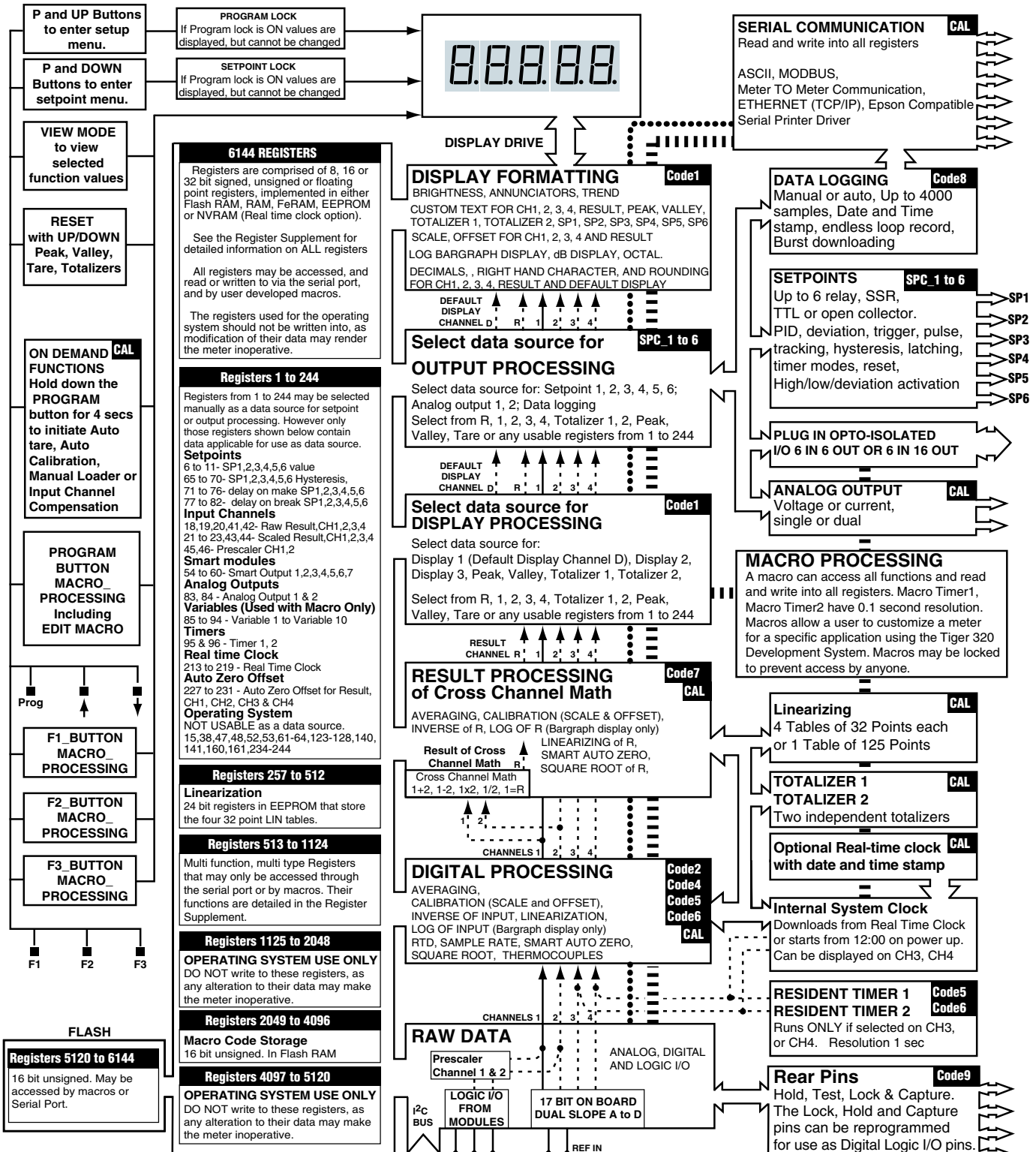

SMART MODULES WITH MULTICHANNEL INPUTS, AN ON-BOARD A TO D CONVERTER, MICROPROCESSOR, AND TWO SOLID STATE RELAY OUTPUTS

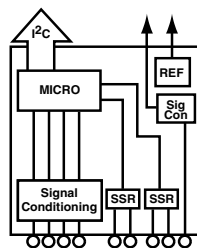

SMART MODULES WITH AN ON BOARD MICROPROCESSOR AND TWO SOLID STATE RELAY OUTPUTS WITH PULSE, OR QUADRATURE ENCODER INPUTS FOR COUNTING, FREQUENCY OR POSITION

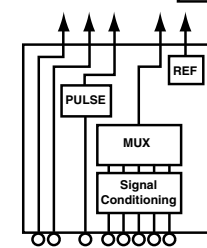

MULTI-INPUT MODULES W/DIGITAL SCALING

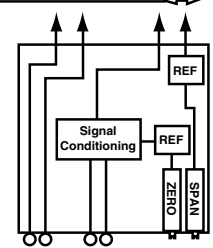

SINGLE INPUT MODULES WITH ANALOG SCALING

THIS PAGE INTENTIONALLY LEFT BLANK

Operational Display

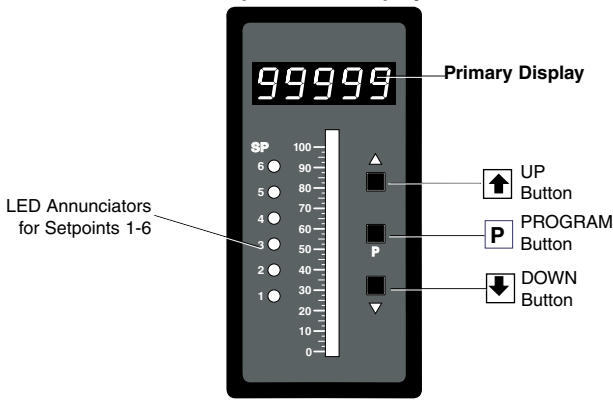

Display with Faceplate and Bezel

Program Button

While programming, pressing the **P** button saves the current programming settings and moves to the next programming step.

You can move through the programming codes using the program button. The codes you pass are not affected, unless you stop and make changes using the **UP** or **DOWN** buttons.

Pressing the **P** and **UP** button at the same time initiates the **main programming mode**. To save a new configuration setting and return to the operational display, press the **P** button once and then press the **P** and **UP** button at the same time.

Pressing the **P** and **DOWN** button at the same time initiates the **setpoint programming mode**. To save a new configuration setting and return to the operational display, press the **P** button once and then press the **P** and **DOWN** button at the same time.

See *Display with Faceplate and Bezel* diagram.

Up Button

When setting a displayed parameter during programming, press the **UP** button to increase the value of the displayed parameter.

When in the operational display, pressing the **UP** button initiates a viewing mode that allows you to view the readings on **channels 1 and 3, setpoints 1, 3, and 5, peak, and total 1**. Once into the viewing routine, pressing the **UP** button moves through each displayed parameter.

See *Display with Faceplate and Bezel* diagram.

Down Button

When setting a displayed parameter during programming, press the **DOWN** button to decrease the value of the displayed parameter.

When in the operational display, pressing the **DOWN** button initiates a viewing mode that allows you to view the readings on **channels 2 and 4, setpoints 2, 4, and 6, valley, and total 2**. Once into the viewing routine, pressing the **DOWN** button moves through each displayed parameter.

See *Display with Faceplate and Bezel* diagram.

Annunciator LEDs

The annunciator LEDs can be programmed to indicate the alarm status.

Setpoint 1 can be configured to indicate the **rising** signal trend. Setpoint 2 can be configured to indicate the **falling** signal trend. They are labeled from left to right: SP1, SP2, SP3, SP4, SP5, SP6.

See *Display with Faceplate and Bezel* diagram.

LED Display

The meter has one 5-digit, 7-segment, 8 mm standard red or optional green LED display. The digital display is the primary display and reads the primary input signal on Channel 1. It is also used to display all meter configuration programming codes.

Bargraph Display

The bargraph display is a 51 segment red or green bargraph that can display the signal from any of four channels or the result of a processed input signal. The bargraph display is known as the secondary display during programming.

Program Lockout Switch

When the PROGRAM LOCKOUT switch is set to position 2, all programmable meter functions can be changed.

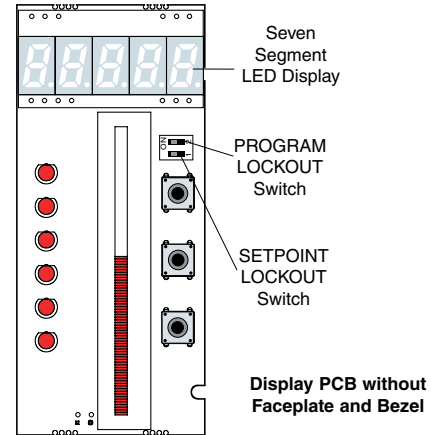

Display Text Editing with 7 Segment Alphanumeric Display Characters

Display text, such as setpoints, can be easily edited to suit your application, by connecting the meter to a PC running the free downloadable Configuration Utility program.

For Example:

Instead of [SP_1]

Instead of [SP_2]



OR

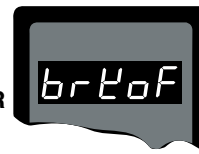

could be used for TANK LOW

could be used for BRAKE OFF

Scrolling Display Text Messaging

Scrolling display text messaging can be configured to run but requires a simple compiler generated macro.

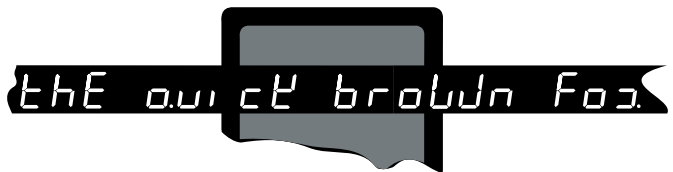

Display Text Characters

The following text characters are used with the 7-segment display.

7-SEGMENT DISPLAY CHARACTERS

1	2	3	4	5	6	7	8	9	0
A	b	c	d	E	F	G	h	i	U
l	L	7	7	n	o	P	a	r	S
t	u	U	U	U	U	U	Y	Z	

Program Lockout Switch

When set to the ON position, the PROGRAM LOCKOUT switch prevents any programming changes being made to the meter. If programming is attempted, the meter displays [LOC]. The ON position allows programming parameters to be viewed but not changed.

See *Display PCB without Faceplate and Bezel diagram*.

Setpoint Lockout Switch

When the SETPOINT LOCKOUT switch is set to position 1, the setpoints can be programmed. Once the setpoint values have been entered and the SETPOINT LOCKOUT switch set to the ON position, the setpoints can be viewed but not changed.

See *Display PCB without Faceplate and Bezel diagram*.

Error Message [Error]

Error messages usually occur during calibration procedures.

The three most likely causes of an error message are:

- 1) The full scale and zero signals were too similar.
Note, the high input (full scale) signal must be at least 1000 counts greater than the low input (zero) signal (positive and negative values are allowed).
- 2) The scaling requirement exceeded the capability of the meter (-99999 to +99999).
- 3) No input signal present, or incorrect connections.

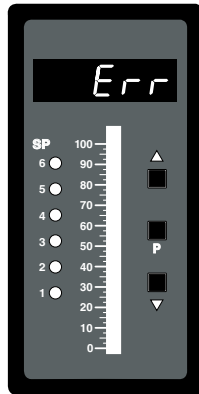

Display Showing Error Message

Rear Panel External Switched Inputs

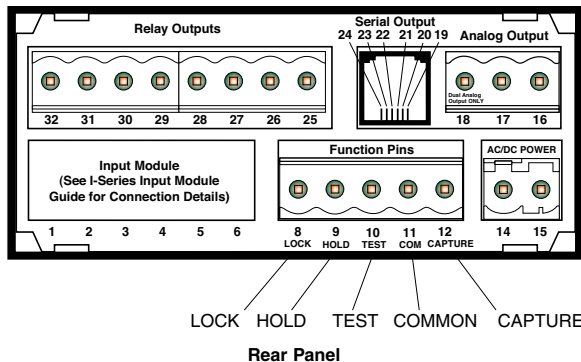

Rear Panel

Lock Pin

By configuring Code 9 to [XX0], connecting the LOCK pin (pin 8 on the main PCB) to the COMMON pin (pin 11 on the main PCB), locks out the main and setpoint programming modes. All meter programming codes and setpoints can be viewed but not changed.

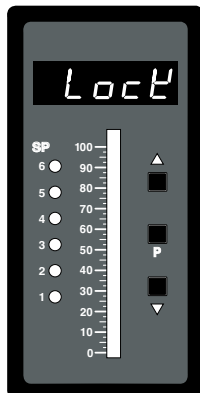

Display Showing LoCK Message

The main programming mode can be entered, but only the brightness setting adjusted. After adjusting the brightness setting, pressing the [P] button displays [LoCK].

The LOCK pin can also be configured in Code 9 to carry out the following functions (see *Meter Programming Codes* on Page 9):

- Reset channel 1 [XX1].
- Reset channel 2 [XX2].
- Reset channel 3 [XX3].
- Reset channel 4 [XX4].
- Reset tare [XX5].
- Reset total 1 [XX6].
- Unlatch (de-energize) all setpoints [XX7].

Hold Pin

Configure Code 9 to [X0X]. When the HOLD pin (pin 9) is connected to the COMMON pin (11) the displayed reading is frozen. However, A/D conversions and all control functions continue and as soon as pin 9 is disconnected from pin 11 by the switch, the updated reading is instantly displayed.

The HOLD pin can also be configured in Code 9 to carry out the following functions (see *Meter Programming Codes* on Page 9):

- Reset channel 1 [X1X].
- Reset total 1 and total 2 [X2X].
- Reset total 2 [X3X].
- Reset peak and valley [X4X].
- Reset tare [X5X].
- Set tare [X6X].
- Unlatch (de-energize) all setpoints [X7X].

Test Pin

Configure Code 9 to [0XX]. When the TEST pin (pin 10) is connected briefly to the COMMON pin (pin 11) all segments of the display and setpoint annunciators light up. Six eights and six decimal points (8.8.8.8.8.) are displayed for a short period. The microprocessor is also reset during this time, losing all RAM settings such as peak and valley, and any digital input pin settings set up in Code 9.

The TEST pin can also be configured in Code 9 to carry out the following (see *Meter Programming Codes* on Page 9):

- Reset counter channel 1 and total 2 at power-up [1XX].
- Reset counters, CH1, CH2, CH3, CH4,- total 1, and total 2 at power-up [2XX].
- Reset total 1 and total 2 at power-up [3XX].

Capture Pin

When the CAPTURE pin (pin 12) is connected to the COMMON pin (pin 11), the CAPTURE pin can be programmed for setpoint/relay activation or macro control applications in the setpoint control settings mode of the setpoint programming mode [SPC__X] [X2X].

Common Pin

To activate the LOCK, HOLD, TEST and CAPTURE pins from the rear of the meter, the respective pins have to be connected to the COMMON pin (pin 11).

Front Panel Push Button Configuration and Setup for Programming Conventions

The meter uses a set of intuitive software codes to allow maximum user flexibility while maintaining an easy programming process. To configure the meter's programming codes, the meter uses the three right-hand side display digits. These are known as the 1st, 2nd, and 3rd digits and can be seen in the diagram opposite. To explain software programming procedures, diagrams are used to visually describe the programming steps. The following conventions

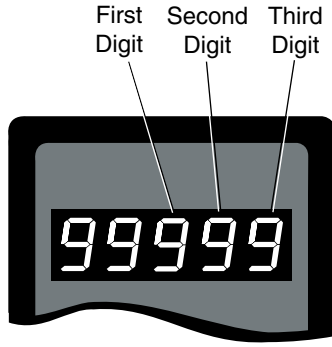

are used throughout the range of Tiger 320 Series document diagrams to represent the buttons and indicators on the meter, and the actions involved in programming the meter:

Symbol

Explanation



The display showing 99999 represents the **OPERATIONAL DISPLAY**. After the meter has been powered up, the display settles and indicates the calibrated input signal. This is known as the operational mode and is generally referred to as the operational display throughout the documentation.

All programming modes are entered from this level.



This symbol represents the **PROGRAM** button. In a procedure, pressing the program button is always indicated by a **left hand**. A number indicates how many times it must be pressed and released, or for how long it must be pressed before releasing.

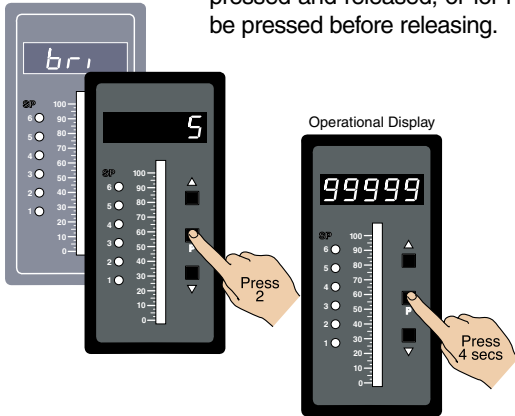



This symbol represents the **UP** button.

Shown in a diagram, pressing the UP button is always indicated by a **right hand**.



This symbol represents the **DOWN** button.

Shown in a diagram, pressing the DOWN button is always indicated by a **right hand**.

Where two right hands are shown on the same diagram with the word OR between them, this indicates that both the  and  buttons can be used to adjust the display: UP for increase, DOWN for decrease.

[Span]
[10000]



Text or numbers shown between square brackets in a description or procedure indicate the programming code name of the function or the value displayed on the meter display.

Programming procedures are graphic based with little descriptive text.

Each procedure shows a number of meter panel displays running in procedural steps from the top to the bottom of the page.

If need be, the procedure may run into two columns with the left column running down the page and continuing at the top of the right-hand column. Each action performed by the user is shown as a numbered step.

Each procedural step shows the meter display as it looks before an action is performed. The hand or hands in the procedural step indicate the action to be performed and also how many times, or for how long, the button is to be pressed.

For example, the diagram below shows the meter in the operational display. With a left hand pressing the  button and a right hand pressing the  button, the user is entering the **main programming mode**. This is indicated by the next diagram displaying [bri] and [5]. This is the display brightness mode and is the first sub-menu of the main programming mode.

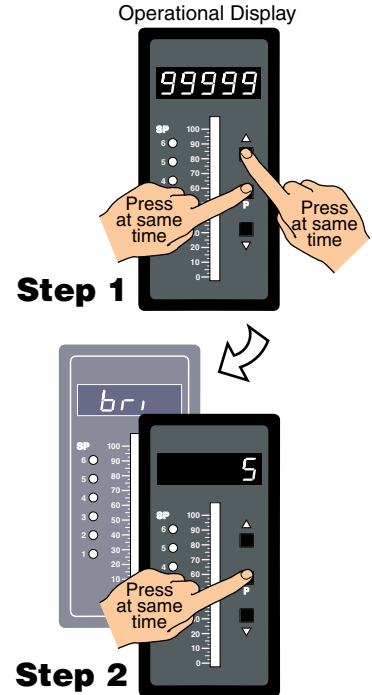

Where a left and right hand are shown on separate buttons on the same diagram, this indicates that the buttons must be pressed at the same time.

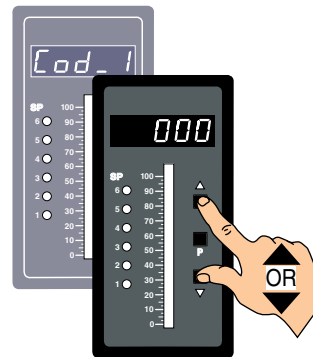

The exceptions to this rule are when carrying out the *Model and Software Code Version Check* or the *Code Blanking and Macro Check*.

When two displays are shown together as black on grey, this indicates that the display is toggling (flashing) between the name of the function and the value or configuration setting.

Where a number is not definable, the default setting [000] is shown.

If an X appears in the description of a 3 digit programming code or in a configuration procedure, this means that any number displayed in that digit is not relevant to the function being explained, or more than one choice can be made.

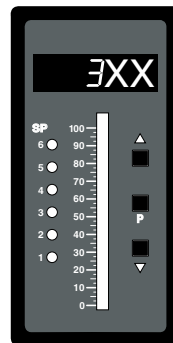

Front Panel Programming Codes

The meter's programming codes are divided into two modes: the **main programming mode**, and the **setpoint programming mode** (See diagram below). Each mode is accessible from the operational display.



Programming Tip

The easiest and fastest way to configure the Tiger 320 is to use a PC with the free downloadable configuration utility program.

Main Programming Mode

The main programming mode provides access to program all meter functions, except setpoints.

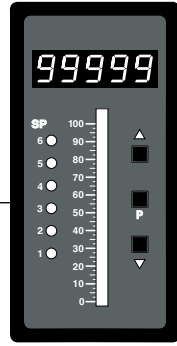

Operational Display



Setpoint Programming Mode

The setpoint programming mode provides access to program all setpoint and relay functions.

To enter or exit the Setpoint Programming Mode, press **P** and **↓** at the same time

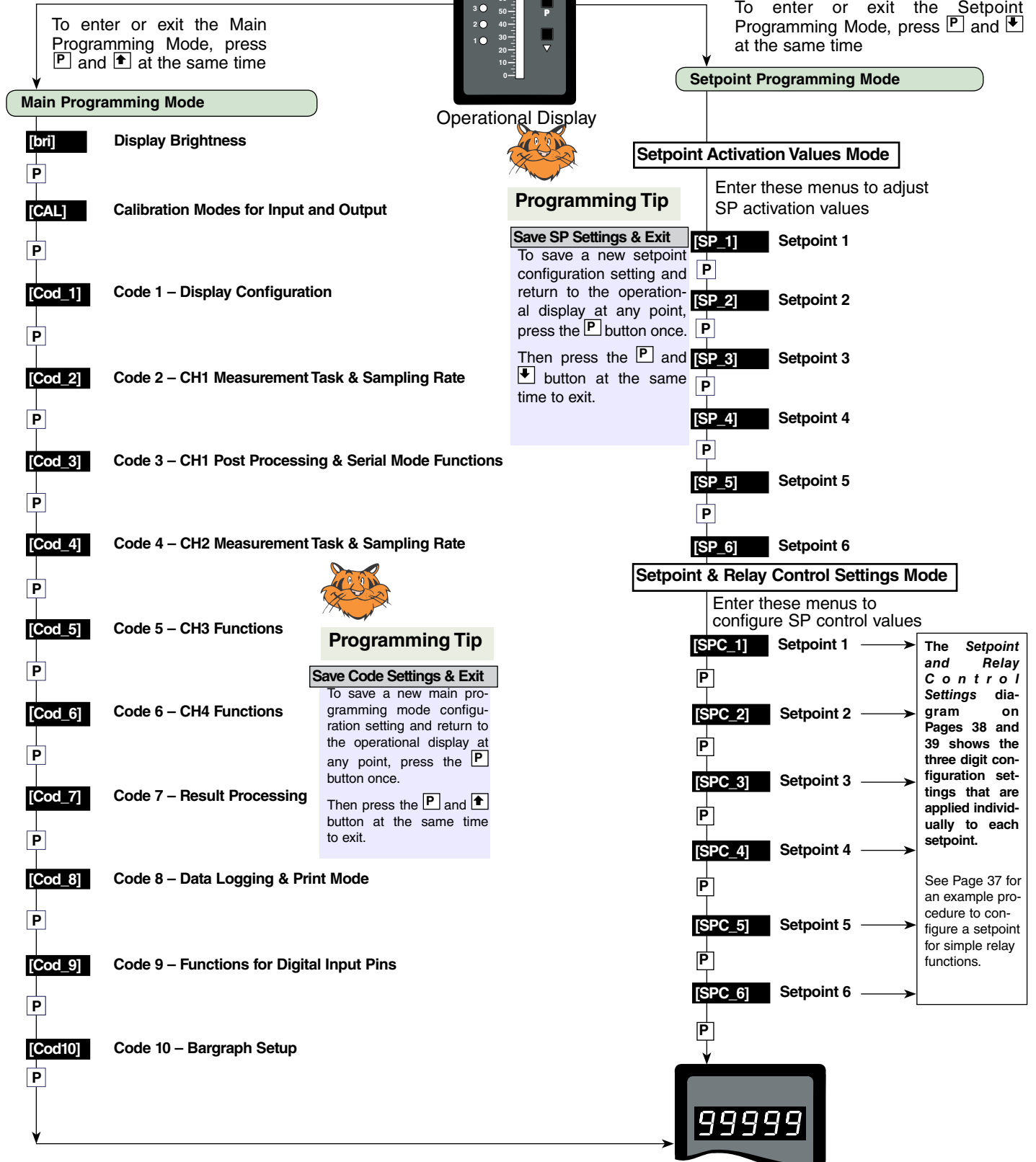

Programming Tip

Save Code Settings & Exit

To save a new main programming mode configuration setting and return to the operational display at any point, press the **P** button once. Then press the **P** and **↑** button at the same time to exit.

Programming Tip

Save SP Settings & Exit

To save a new setpoint configuration setting and return to the operational display at any point, press the **P** button once. Then press the **P** and **↓** button at the same time to exit.

Enter these menus to adjust SP activation values

Enter these menus to configure SP control values

The *Setpoint and Relay Control Settings* diagram on Pages 38 and 39 shows the three digit configuration settings that are applied individually to each setpoint. See Page 37 for an example procedure to configure a setpoint for simple relay functions.

View Modes

While in the operational display, pressing the **↑** button allows you to view but not change the following parameters:

- Channel 1.
- Channel 3.
- Setpoint 1.
- Setpoint 3.
- Setpoint 5.
- Peak (of CH1).
- Total 1 (total of CH1).

While in the operational display, pressing the **↓** button allows you to view but not change the following parameters:

- Channel 2.
- Channel 4.
- Setpoint 2.
- Setpoint 4.
- Setpoint 6.
- Valley (of CH1).
- Total 2 (total of CH2).

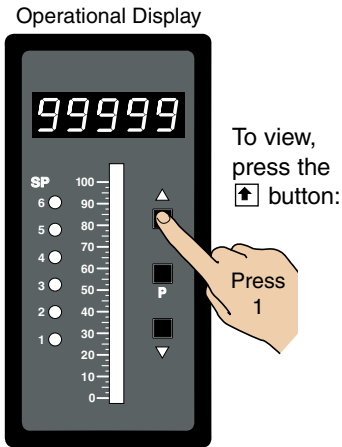

View Mode

- SP_1**
- ↑**
- SP_3**
- ↑**
- SP_5**
- ↑**
- PEAK**
- ↑**
- tot_1**
- ↑**
- Ch1**
- ↑**
- Ch3**
- P**

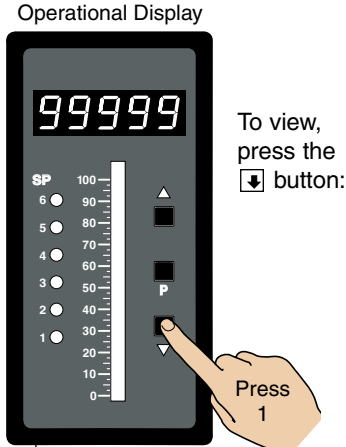

View Mode

- SP_2**
- ↓**
- SP_4**
- ↓**
- SP_6**
- ↓**
- VALEY**
- ↓**
- tot_2**
- ↓**
- Ch2**
- ↓**
- Ch4**
- P**



On Demand Modes

The meter can be programmed to activate the following functions on demand by pressing the **P** button for 4 seconds:

- Tare.
- Single-point calibration.
- Two-point calibration.
- Primary input compensation.
- Manual loader (manual offset).
- Print.

The on demand function is selected in the calibration mode.



After configuring an on demand function in the **Calibration On Demand Mode**, press the **P** button for 4 seconds to activate one of the following selected on demand modes.

On Demand Modes

- Tare**
- OR**
- Single-point calibration**
- OR**
- Two-point calibration**
- OR**
- Primary input compensation**
- OR**
- Manual loader (manual offset)**
- OR**
- Print**

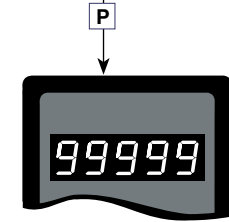

For a full breakdown of all programming codes, see the *Tiger 320 Series Programming Code Sheet (NZ101)*.

Initial Setup Procedures

Before configuring the meter, carry out the following meter configuration checks:

- Model and software code version check.
- Code blanking and macro check.

After powering-up the meter, check the model and software code version number and note this in your user manual.

Model and Software Code Version Check

The meter model and software code version number can be checked at any time while in the operational display using the following procedure.

START HERE

MODEL & SOFTWARE CODE VERSION CHECK

Step 1

Press and hold the and buttons

Operational Display

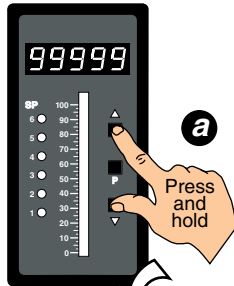

Step 2

While holding both buttons, press the Prog. button then release all three buttons

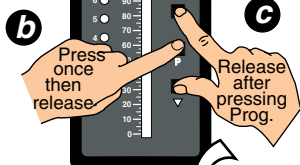

Example

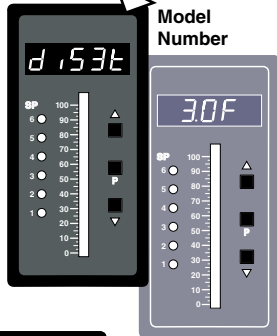

Step 3

The displays toggle three times. If a macro is installed and turned on, the customer ID and the macro ID scroll across the display before returning to the operational display.



Operational Display

Model No:.....
 Software Version No:.....
 Customer ID:.....
 Macro ID:.....



Programming Tip

The *Model and Software Code Version* checking procedure can be performed at any time without interfering with other configuration settings.

Code Blanking and Macro Check

Tiger 320 Series meters have the ability to hide (blank out) all or some programming codes, making them tamper-proof. This can only be done using the Meter Configuration program.

With code blanking turned ON, all main and setpoint codes that have been blanked out during factory programming are hidden, preventing them from being reprogrammed. Any codes that have not been blanked out are still visible and can be reprogrammed.

Turning code blanking OFF means all meter programming codes are visible when you enter the programming modes and can be reprogrammed.

A macro is a set of commands that run automatically when the meter is powered up. We have a growing library of macros to suit a wide range of standard customer applications.

Macros can be installed in the meter at the factory during initial programming or by the customer at some later date. Macros are written and compiled using the BASIC Compiler program, and loaded into the meter using either the BASIC Compiler program or the Meter Configuration program.

Turning the macro OFF means that the meter will not perform the automatic commands pre-programmed to run with the macro.

Unless requested to blank out all or some programming codes and/or run a macro, We program the meter in the code blanking OFF and macro OFF (default) setting.

To turn the code blanking and macro settings from ON to OFF:

START HERE

CODE BLANKING & MACRO CHECK PROCEDURE

Step 1

Press and hold the and buttons

Operational Display

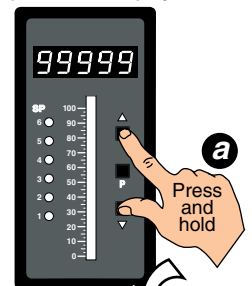

Step 2

While holding both buttons, press the Prog. button.

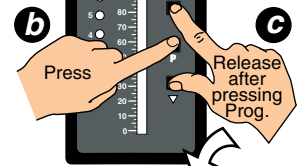

Step 3

Release the and buttons and hold the Prog. button for approx. 1 sec then release



Code Blanking & Macro Check Procedure

continued on next page (Step 4)

continued from Step 3

Example

NOTE: Unless otherwise requested, the factory default setting is OFF

Step 4

Press the  button to switch code blanking OFF

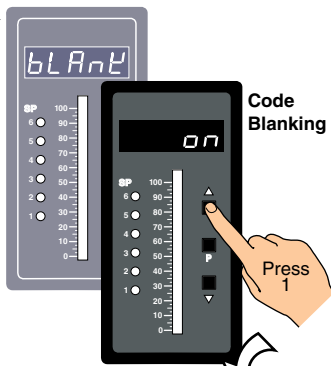

Step 5

Press the Prog. button.

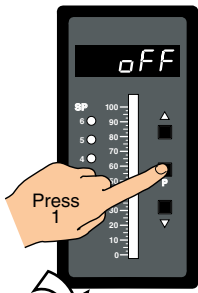

Example

Macro

Step 6

Press the  button to switch the macro OFF

NOTE: Unless otherwise requested, the factory default setting is OFF

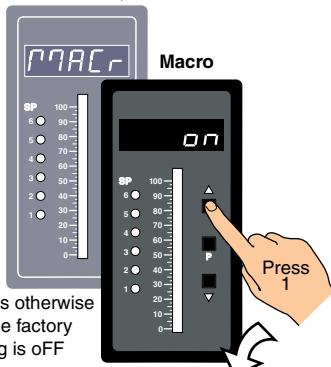

Step 7

Press the Prog. button.

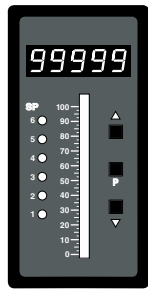
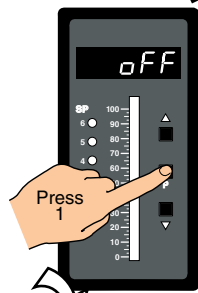

Operational Display

Display Configuration

Once you have read the User manual and related supplements, and installed and powered-up the meter, configure the display to suit its designated application.

Display Brightness Mode

The **display brightness mode** is accessed when entering the main programming mode. It allows you to adjust the brightness of the display LEDs and setpoint annunciators without interfering with other configuration settings. It is always available, even with the PROGRAM LOCK switch set to ON, or the external LOCK pin connected to the COMMON pin, locking out the programming modes.

The display brightness can be set between 0 and 7, with 0 being dull and 7 being bright. 5 is the default setting.

Example Procedure:

Configure the display brightness setting to 7 (bright).

START HERE

DISPLAY BRIGHTNESS MODE

Step 1

Enter Brightness Mode

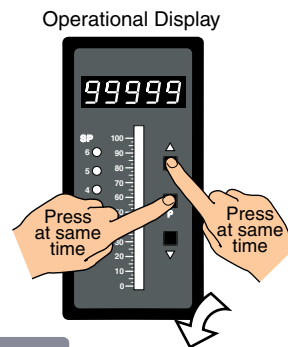

Step 2

Adjust brightness to 7

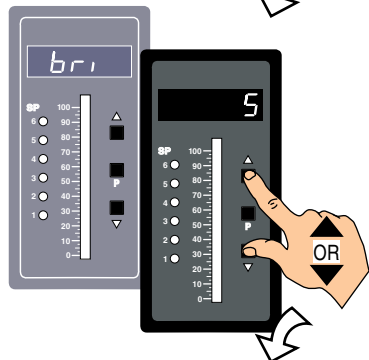

Example

Step 3

Save brightness setting. Exit Brightness Mode. Return to Operational Display

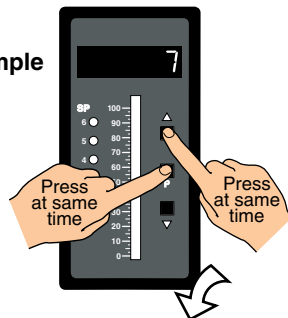

Operational Display



Programming Tip

Code Blanking and Macro ON/OFF settings revert to the meter's original configuration settings when the meter is powered off and on.



Programming Tip

The *Display Brightness* setting procedure can be performed at any time without interfering with other configuration settings by entering the main programming mode.

[CAL] - Calibration Modes for Input and Output

The Tiger 320 Series meter has an extremely powerful set of input and output calibration modes. See Diagram below.

Functions Activated by **P** Button Mode

In this mode the meter can be programmed to activate one of the following on demand functions by pressing the **P** button while in the operational display:

- On Demand TARE.
- On Demand Single-point Calibration (requires single input source).
- On Demand Two-point Calibration (requires dual input source).
- On Demand Primary Input Compensation Mode.
- On Demand Manual Loader Mode.

Calibration Modes

The following calibration modes are available:

- Manual Calibration (requires NO input source).
- Two-point Calibration (requires dual input source).
This is the calibration mode generally used to calibrate the meter for most applications. An example procedure has been included.
- Calibrate Thermocouple (requires K type thermocouple input source).
- Calibrate RTD (requires RTD 385 input source).
- Calibrate Smart Input Module (not available on all input modules).
- Calibrate Analog Output (requires multimeter connected to pins 16 and 17).

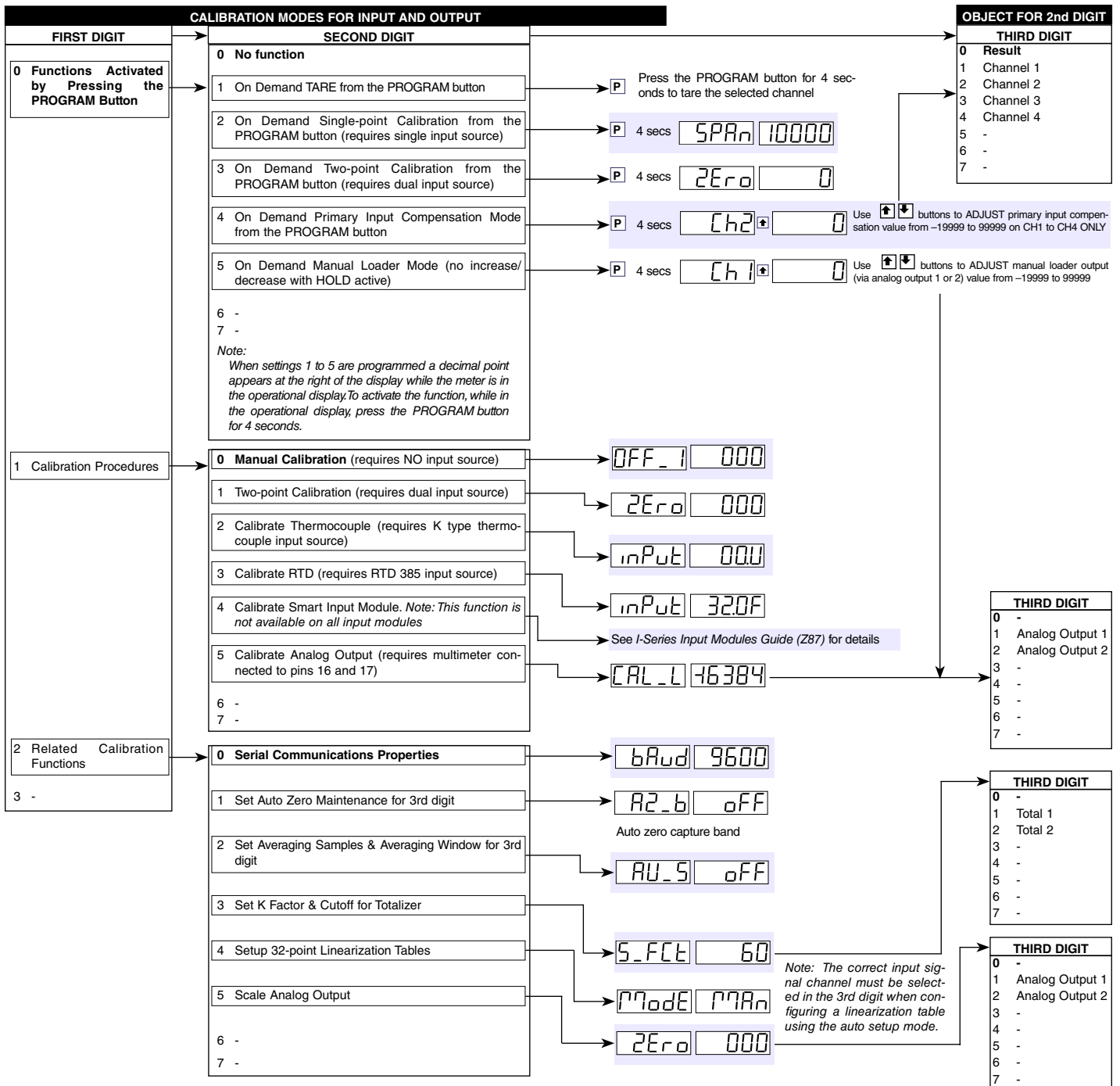

Related Calibration Functions

The following functions are also configured in the calibration mode. See *Advanced Calibration and On Demand Mode Supplement (NZ203)* for further calibration details.

Serial Communications Properties

Selecting [CAL][20X] enters the Serial Communications Properties Mode.

This mode allows you to configure the serial communications output module baud rate, parity, time delay, and address settings.

See the **calibration modes** diagram on Page 13 showing a breakdown of 1st, 2nd, and 3rd digits.

Also see the *Serial Communications Module Supplement (NZ202)* for further details on the serial communications module.

Set Auto Zero Maintenance

Selecting [CAL][21X] enters the Set Auto Zero Maintenance Mode.

This mode allows you to configure auto zero maintenance settings for weighing applications applied to the channel selected in the 3rd digit.

See the **calibration modes** diagram on Page 13 showing a breakdown of 1st, 2nd, and 3rd digits.

Set Averaging Samples & Averaging Window

Selecting [CAL][22X] enters the Set Averaging Samples and Averaging Windows Mode.

This mode allows you to configure the number of input signal samples to average over, and the size of the averaging window in display counts applied to the channel selected in the 3rd digit.

Selecting [CAL][22X] enters the Set Averaging Samples and Averaging Windows Mode. When in this mode, the [AV_S] menu allows you to select the number of input signal samples to average over. After setting the number of samples, moving to the [AV_W] menu allows you to configure the size of the averaging window in displayed counts.

The meter averages the input samples over the selected number of input samples (selected in the [AV_S] menu). This carries on in a continual process provided the input signal stays within the averaging window (set in the [AV_W] menu). If the sample moves out of the averaging window, the meter responds quickly to the change by displaying the non-averaged signal value. When the signal stabilizes, a new averaging window is established and averaging resumes.

You can program the number of samples you want to average the input signal over from 1 to 255 samples. The averaging window can be set to between 1 and 65535 counts.

See the **calibration modes** diagram on Page 13 showing a breakdown of 1st, 2nd, and 3rd digits.

See *Input Signal Sampling Showing Averaging Window diagram* opposite.

Example Procedure

The example procedure on Page 16 shows how to configure channel 1 (CH1) with an averaging sample rate of 10 counts and an averaging window of 1000 counts.

Totalizer Settings

Selecting [CAL][23X] enters the Totalizer Settings Mode.

This mode allows you to configure the settings for the totalizer

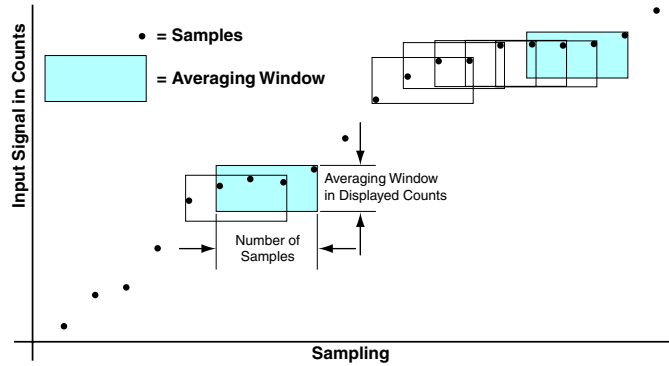

Input Signal Sampling Showing Averaging Window

selected in the 3rd digit. An input value of 10000 counts is applied to a selectable time period to produce the required total value.

The cutoff is a programmable limit below which the input is not totalized.

See the **calibration modes** diagram on Page 13 showing a breakdown of 1st, 2nd, and 3rd digits.

Also see the *Totalizing and Batching Supplement (NZ208)* for further details on K factor and totalizer cutoff parameters.

Setup 32-point Linearization Tables

Selecting [CAL][24X] enters the Setup 32-point Linearization Tables Mode.

This mode allows you to set up the linearization table or tables using the manual or auto setup modes. The table or tables can then be selected to linearize the signals on channels 1 to 4.

See **Linearization Table Notes** on Page 32 for a description of memory related issues with linearization.

See the **calibration modes** diagram on Page 13 showing a breakdown of 1st, 2nd, and 3rd digits.

Also see the *Linearizing Supplement (NZ207)* for further details on linearization table setup and use.

Scale Analog Output

Selecting [CAL][25X] enters the Scale Analog Output Mode.

This mode allows you to calibrate and scale the analog output signal. Before calibrating the analog output in the calibration mode, the data source for the analog output must be configured in Code 1.

See the **calibration modes** diagram on Page 13 showing a breakdown of 1st, 2nd, and 3rd digits.

Also see the *Analog Output Module Supplement (NZ200)* for further details on the analog output module.

Also see *Configure Data Source Procedure* on Page 21 for an example of setting the analog output data source.

Calibration Mode Procedures Supplement

The *Advanced Calibration and On Demand Mode Procedures Supplement (NZ203)* describes in detail all Tiger 320 Series meter related calibration procedures configured in the calibration mode.

Two-point Calibration

Two-point calibration is the most commonly used method of calibrating Tiger 320 Series meters when a low and high input source is available.

Example Calibration Procedure

Calibrate channel 1 (CH1) using the two-point calibration method. The calibration mode display is set to [111].

The low input source is applied to the meter when setting the zero value.

The high input source is applied to the meter when setting the span value.

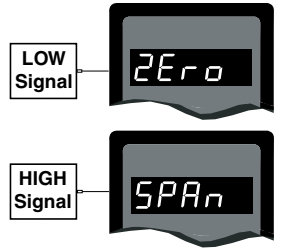

START HERE

TWO-POINT CALIBRATION

Step 1

Enter Brightness Mode

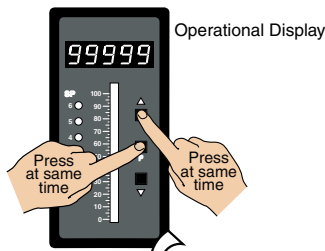

Step 2

Pass Brightness Mode and enter Calibration Mode

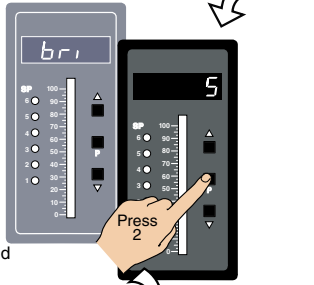

Step 3

Set Calibration Mode to [111]:
 1st Digit = 1
 Selects calibration procedures
 2nd Digit = 1
 Selects 2-point calibration
 3rd Digit = 1
 Selects CH1 for calibration

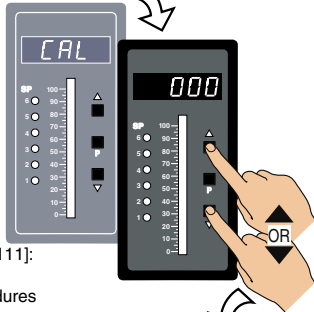

Step 4

Enter Cal Mode [111]
 For 2-point calibration of CH1

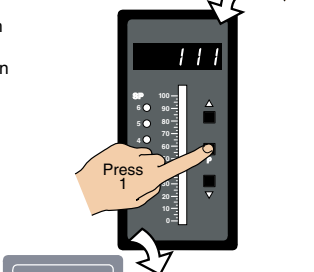

Step 5

5.1. Adjust display to desired reading for zero input
 5.2. Apply the LOW input signal

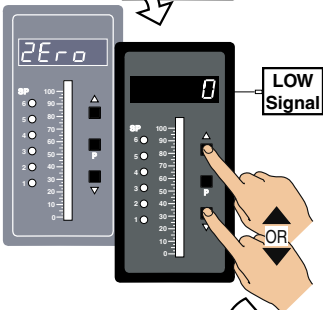

Step 6

Set reading for zero load into meter and enter Span Mode

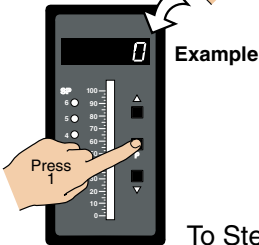

From Step 6

Step 7

7.1. Adjust display to desired reading for span input
 7.2. Apply the HIGH input signal

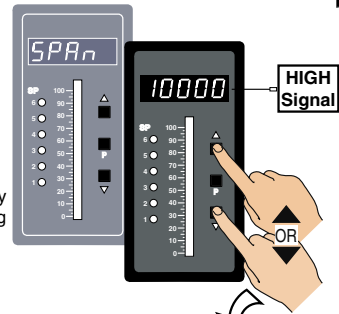

Step 8

Save zero and span settings and re-enter Calibration Mode

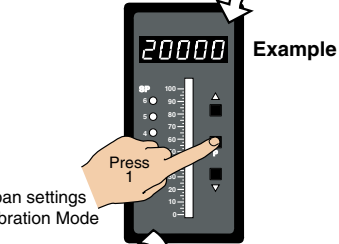

Step 9

Select the No Function Calibration Mode [000]

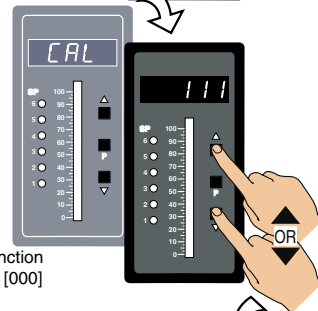

Step 10

Save Calibration Mode [000] setting and enter Code 1

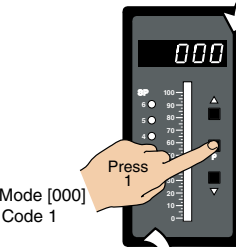

Step 11

Exit Code 1. Return to Operational Display

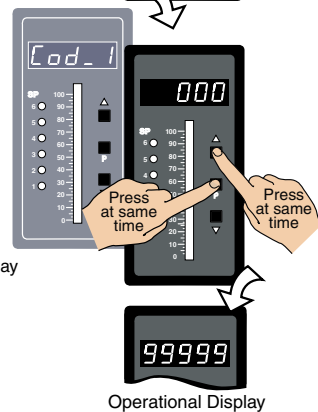

Input Signal Filtering and Averaging

Input signal filtering and averaging is configured in the calibration mode. Programmable averaging allows you to program the number of samples you want to average the input signal over (from 1 to 255 samples).

A programmable averaging window provides a quick response time to large input signal changes. The averaging window can be set to between 1 and 65535 counts.

Example Procedure:

Select an averaging sampling rate of 10 samples and an averaging window of 10000 counts for Channel 1 by setting [CAL] to [221].

See Advanced Calibration & On Demand Mode Supplement (NZ203) for further calibration procedures.

START HERE

INPUT SIGNAL FILTERING & AVERAGING

Step 1

Enter Brightness Mode

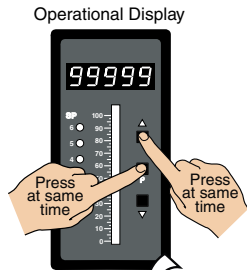

Step 2

Pass Brightness Mode and enter Calibration Mode

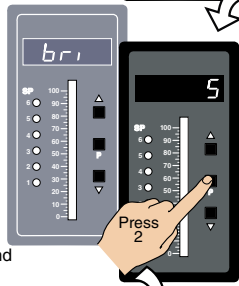

Step 3

Set Calibration Mode to [221]:
 1st Digit = 2 Selects related calibration functions
 2nd Digit = 2 Selects averaging samples for 3rd digit
 3rd Digit = 1 Selects channel 1 for 2nd digit

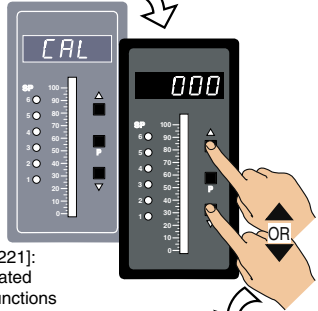

Step 4

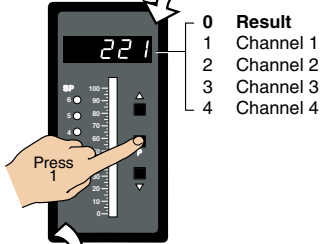

Step 5

Select averaging sampling rate from 1 to 255 samples

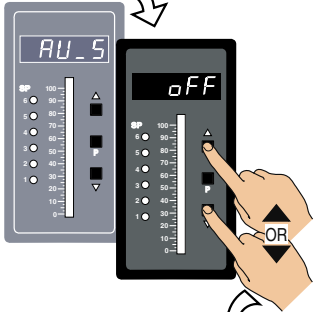

Step 6

Save averaging sampling rate setting

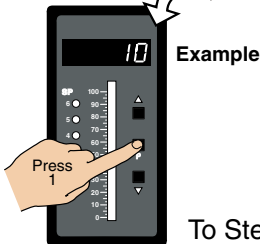

To Step 7

From Step 6

Step 7

Select averaging window between 1 and 65535 counts

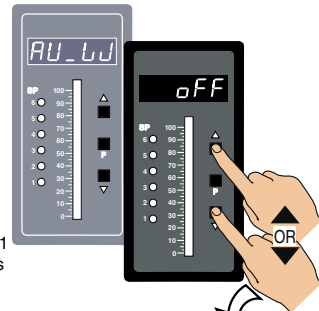

Step 8

Save averaging window settings

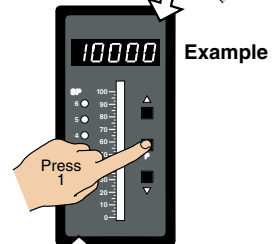

Step 9

Select [000] to leave the Calibration Mode

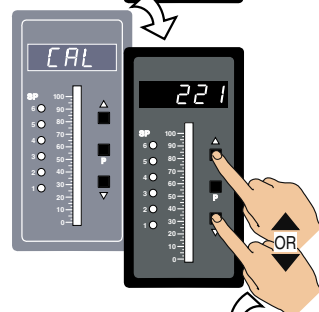

Step 10

Save settings

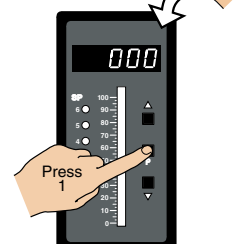

Step 11

Exit Code 1. Return to Operational Display

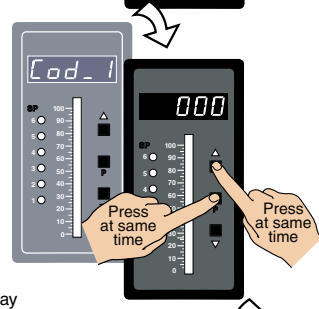

Operational Display

[Code 1] - Display Configuration

All digital display configuration modes, except the display brightness mode, are configured in Code 1.

All bargraph display configuration modes are configured in Code 10 (See diagram below).

See Code 1 diagram on Page 22 for a breakdown of 1st, 2nd, and 3rd digit settings.

See Code 10 diagram on Page 23 for a breakdown of 1st, 2nd, and 3rd digit settings.

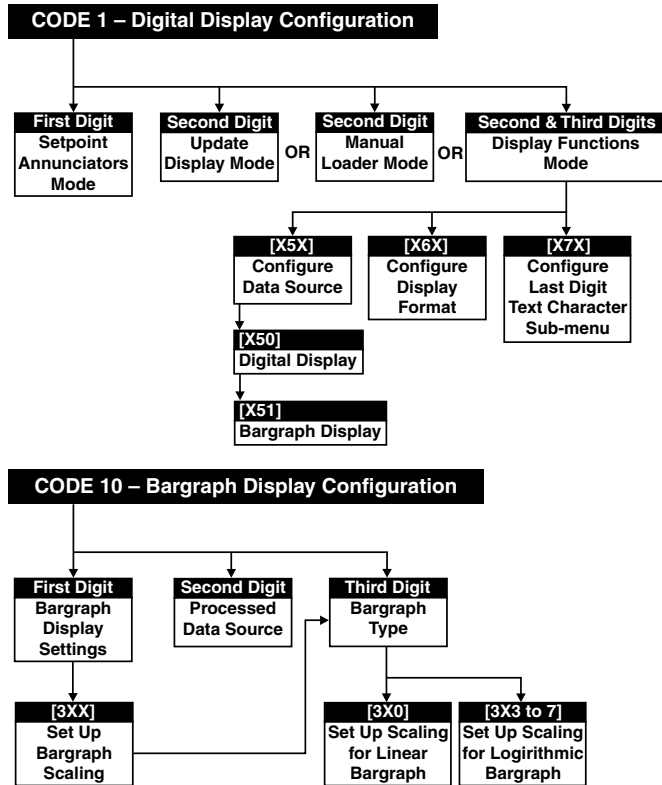

CODE 1 – Digital Display Configuration

Setpoint Annunciators Mode

The setpoint annunciators mode is configured by changing the first digit in Code 1. The setpoint annunciators can be configured to operate as follows:

- On when the setpoint activates.
- All annunciators are permanently on and each one only goes off when its setpoint activates.
- All annunciators are always off (See Note 1 on Code 1 diagram on Page 22).
- Setpoint 1 annunciator comes **on** indicating a **rising signal**. Setpoint 2 annunciator comes **on** indicating a **falling signal**.

Example Procedure. The example procedure on Page 29 shows how to select the setpoint annunciators to come ON when the setpoints are OFF (not active).

Update Display at Selected Sample Rate

The meter's default display update rate is 0.5 seconds and is set in the second digit of Code 1 as [X0X].

The display can be configured to update at the input signal sample rate selected in Code 2.

Example Procedure. The example procedure on Page 29 shows

how to configure the display to update at 50 samples per second by setting Code 1 to [X2X].

For these settings to take effect, the analog sample rate must be set at [2XX] in Code 2. See Code 2 – Channel 1 Measurement Task and Sampling Rate on Page 27 for an example.

Manual Loader Mode

The meter can be configured to function exclusively as a manual loader by setting Code 1 to [X1X].

See Analog Output Module Supplement (NZ200) for full details on manual loader mode functions.

Display Functions Mode

The display functions mode is configured by changing the 2nd and 3rd digits in Code 1:

- Selecting [X5X] enters the **Data Source** sub-menu.
- Selecting [X6X] enters the **Display Format** sub-menu.
- Selecting [X7X] enters the **Last Digit Text Character** sub-menu.

Data Source – 2nd Digit [X5X]

The **digital** display is the **primary** display. The **bargraph** display is the **secondary** display.

To select the data source for the **primary** display select 5 in the 2nd digit and 0 in the 3rd digit [X50].

To select the data source for the **secondary** display select 5 in the 2nd digit and 1 in the 3rd digit [X51].

Selecting 5 in the 2nd digit enters a sub-menu and allows the data from one of a number of meter registers to be selected as the data source for the displays or functions selected in the third digit.

Example Procedure. The example procedure on Page 21 shows how to select the data source for the **primary** display. The three digits are set to [X50]. The same example can be used for selecting the data source for the **secondary** display (bargraph). The three digits are set to [X51].

The 2nd digit in Code 1 can also be used to select the data source for the remaining functions in the 3rd digit:

- [X53] = Peak and Valley.
- [X54] = Analog Output 1.
- [X55] = Analog Output 2.
- [X56] = Totalizer 1.
- [X57] = Totalizer 2.

Display Format – 2nd Digit [X6X]

Selecting 6 in the 2nd digit enters the Display Format sub-menu where the following display format settings can all be configured:

- Last digit rounding.
- Display units (Decimal, octal, or optional 12 or 24-hour clock).
- Decimal point placement.

Example Procedure. The example procedure on Page 27 shows how to configure the three display format modes for the 3rd digit selection.

Text Character – 2nd Digit [X7X]

Selecting 7 in the 2nd digit allows you to select one of 54 characters and apply it to the last digit when the meter is in the operational display.

For example, if the meter was measuring a temperature, the display could be configured to display the reading with a C or an F in the last digit for °C or °F.

Example Procedure. The example procedure on Page 23 shows how to configure the last digit text character as “C” for centigrade (°C) for the 3rd digit selection.

Note:
After setting any or all the above three modes [X5X], [X6X], [X7X], the Code 1 display must be set back to [X0X] to leave Code 1 and carry on programming.

Set Up Bargraph Scaling

This mode is where the span range of the bargraph is scaled. The span range of the bargraph can be set between -19999 to 99999 counts. There are three methods of scaling the bargraph:

- Linear.
- Via Linearization Table 1.
- Logarithmic.

Selecting 3 in the 1st digit enters the Set Up Bargraph Scaling mode.

Linear Bargraph Scaling

The most common method of scaling the bargraph is through the Linear Bargraph Scaling sub-menu. In this menu the bar low, bar high, and bar nominal settings are set.

Bar Low [bAr_L] is the setting in counts required at the bottom of the bargraph.

Bar High [bAr_h] is the setting in counts required at the top of the bargraph.

Bar Nominal sets the point on the bargraph at which the bar begins to light up. This can be any position between and including the bar low and bar high settings.

If bar nominal is set to the **bar low** setting, the bargraph behaves like a typical bargraph making the segments light up from the **bottom** of the bar and grow towards the top.

If bar nominal is set to the **bar high** setting, this makes all segments from the displayed signal to the **top** of the bar light up. As the signal increases, the number of lit segments between the signal and the bar high setting becomes steadily less. When the signal reaches the bar high setting no segments are lit.

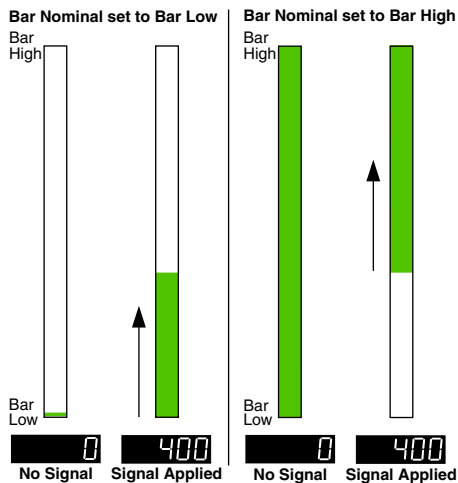

Bargraph Nominal Set Low or High

Setting bar nominal to the midpoint between bar low and bar high makes the bargraph behave like a typical center zero bargraph. This means the bargraph lights up at the center of the bar and moves either up or down the bar depending on the displayed signal.

For example, if the meter's full scale range is 20,000 counts, the midpoint is 10,000 counts. If a signal of 10,000 counts is applied, only one segment at the 10,000 count mark lights up. If a signal of 17,000 counts is applied, the segments between the center segment (10,000 counts) and the 17,000 count mark light up.

If a signal of 5000 counts is applied, the segments between the center segment (10,000 counts) and the 5000 count mark light up.

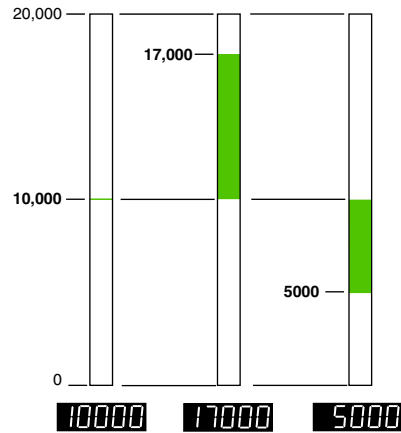

Typical Center Zero Bargraph

An added feature of this bargraph is that it can also be non-symmetrical. This means that the bar nominal setting does not need to be set at the mid-point between bar low and bar high. For example, if the bargraph is configured to display -200 to 800 °C, bar low is set to -200 counts and bar high is set to 800 counts. Bar nominal is set to 0 counts. If a signal of -50 °C is applied, the bar lights from 0 down to -50. If a signal of 600 °C is applied, the bar lights from 0 up to 600.

Example Procedure. The example procedure on Page 25 shows how to scale the bargraph using linear scaling.

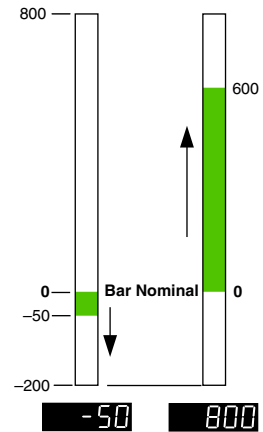

Non-symmetrical Zero Bargraph

Bargraph Scaling using Linearization Table 1

When set in this mode, the register selected to be displayed on the bargraph display (Code 1 set to [XX1]) is first processed through a 32-point flexible linearization table (Table 1) before being displayed.

This can be used, for example, if channel 1 is the required digital display while the bargraph display is the square root of channel 1.

See *Linearization Supplement (NZ207)* for full details to set up linearization Table 1.

Selecting 3 in the 1st digit and 1 in the 3rd digit selects Bargraph scaling via Linearization Table 1.

Example Procedure. To scale the bargraph using Linearization Table 1, follow the *Scale Bargraph using Linear Scaling Procedure* on Page 25. Ensure the secondary (bargraph) display has been set up in Code 1 and Linearization Table 1 has been formatted and selected for the required application.

Logarithmic Bargraph Scaling

Logarithmic scales are used in a wide variety of measurements. Probably the most well known logarithmic scale is the Richter scale for measuring earthquakes. Other log scales used include sound level (dB), radio frequency signals, power levels (dBm), and numerous radiation signals.

In all logarithmic scales a reference level is required that is the level at 0 dB. For example, in an RF measurement 0 dBm is at a reference of 1 mW.

The scale is calculated from:

$$10 \log_{10} \frac{\text{counts (input)}}{\text{reference}}$$

If the meter is scaled so that:

1 mW = 100 counts and 1 W = 100,000 counts

Then the reference for 0 dBm would be set to 100 counts:

$$10 \log_{10} \frac{\text{(input)}}{100} = 0 \text{ dBm}$$

Decade (Counts)	dBm
1	-20
10	-10
100	0
1000	10
10,000	20
100,000	30
1,000,000	40

Now every 10 dBm represents a decade, the bargraph can be scaled to a different amount of bars per decade (as set in the 3rd digit).

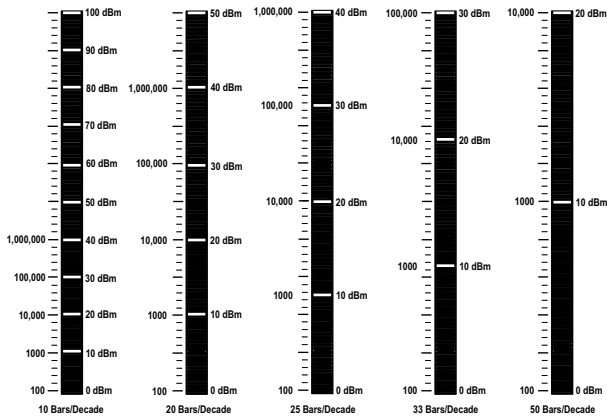

Example of Bars per Decade

Reference. This is the number of counts displayed for a 0 dB reference. Range: 1 to 99999 counts.

Bar Nominal. See Bar Nominal description under heading: *Linear Bargraph Scaling.*

Selecting **3** in the 1st digit and **3, 4, 5, 6, or 7** in the 3rd digit enters the Set Up Scaling for Logarithmic Bargraph sub-menu:

- Selecting **3** in the 3rd digit sets the log to 10 Bar/Decade.
- Selecting **4** in the 3rd digit sets the log to 20 Bar/Decade.
- Selecting **5** in the 3rd digit sets the log to 25 Bar/Decade.

- Selecting **6** in the 3rd digit sets the log to 33 Bar/Decade.
- Selecting **7** in the 3rd digit sets the log to 50 Bar/Decade.

Example Procedure. The example procedure on Page 26 shows how to scale the bargraph using example logarithmic settings.

Bargraph Display Format

After the bargraph colors have been set and the bargraph scaled, the display format can be set. This is normally the final setting. The 2nd digit selects the format of the bargraph display. There are four display format settings available:

- **Setpoints on Bar.** Selecting [X0X] means that the setpoints are displayed on the bar as lit segments in the current display color. When the bargraph lights up on or beyond a setpoint, the setpoint segment goes out.

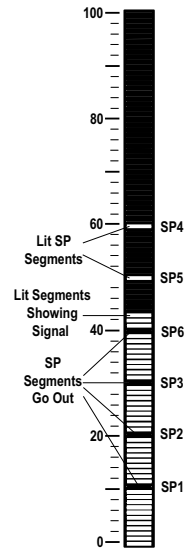

Example of Setpoints on Bargraph

- **Peak and Valley on Bar.** Selecting [X1X] means that peak and valley are displayed as lit segments and are updated as they change. The setpoints are not displayed.
- **Min/Max with Setpoints.** Selecting [X4X] means that the segments of the bar remain lit over the minimum and maximum signal variations. The setpoints are displayed as lit segments.

This is a useful mode for seeing process variations at a glance.

Note:

When moving from another display format to the **Min/Max with Setpoints** mode, the peak and valley settings must be set to the current settings by entering the Peak View mode or Valley View mode and pressing the UP and DOWN buttons at the same time.

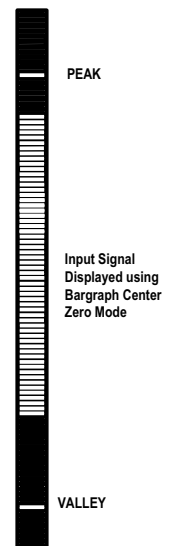

Example: Peak and Valley on Bargraph

When moving from **Min/Max with Setpoints** mode to another display format, the bar nominal [bAr_n] setting must be reset to its original settings in Code 10 [3XX].

- **Bar Only.** Selecting [X7X] means that only the bargraph display signal is displayed on the bar. Setpoints and peak and valley are not displayed.

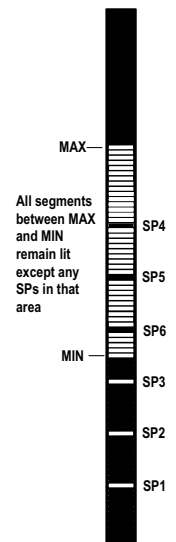

Example: MIN and MAX on Bargraph

[Code 1] - Display Configuration continued

FIRST DIGIT	SECOND DIGIT	THIRD DIGIT	Select Display Format
CODE 1 – DISPLAY CONFIGURATION			
FRONT PANEL ANNUCIATORS	DISPLAY FUNCTIONS	SELECT DATA SOURCE FOR	SELECT DISPLAY FORMAT FOR
<ul style="list-style-type: none"> 0 ON when Setpoints are ON (relay energized) 1 ON when Setpoints are OFF (relay de-energized) 2 Always OFF. See Note 1 3 LED SP1 ON indicates RISING signal trend. LED SP2 ON indicates FALLING signal trend. 	<ul style="list-style-type: none"> 0 Normal Display Mode (i.e. operational display shows selected register) updates every 0.5 seconds 1 Manual Loader Mode (Direct Display). See Note* 2 Update at sample rate selected in Code 2 3 - 4 - 5 Select data source as per 3rd digit. See Note 4 6 Select display format as per 3rd digit. See Note 4 7 Select text character as per 3rd digit. See Note 4 	<ul style="list-style-type: none"> 0 Primary Display 1 Second Display. See Note 2 2 Third Display. See Note 2 3 Peak/Valley 4 Analog Output 1 5 Analog Output 2 6 Totalizer 1 7 Totalizer 2 	<ul style="list-style-type: none"> 0 Result 1 Channel 1 2 Channel 2 3 Channel 3 4 Channel 4 5 Default Display 6 Total 1 7 Total 2

Select Data Source
See diagram below

Select Last Digit Text Character
See diagram below

Note: For the Manual Loader Mode (Direct Display) to work, with Code 1 set to [X54] the data source for the analog output (1 or 2) must be set to [diSP]. Operating range upper and lower limits can be set for the manual loader mode. The setpoint activation values for setpoint 5 becomes the upper limit and setpoint 6 becomes the lower limit. When either the direct display or on demand manual loader mode is programmed into the meter, the values for setpoint 5 and setpoint 6 are activated as upper and lower limits.*

See Analog Output Supplement for further details.

Note 1: LED annunciators are always off, except when the meter is in single channel VOLTAGE or CURRENT mode and Code 3 = [X6X], or Code 7 = [X6X] in which case the LEDs indicate which 32-point table has been selected from the rear pins (SP1 = Table 1, SP2 = Table 2, SP3 = Table 3, SP4 = Table 4).

Display Format Mode

Program the three digits to the required display function mode

FIRST DIGIT	SECOND DIGIT	THIRD DIGIT
LAST DIGIT ROUNDING	DISPLAY UNITS	DECIMAL POINT PLACEMENT
<ul style="list-style-type: none"> 0 No rounding 1 Rounding by 2's 2 Rounding by 5's 3 Rounding by 10's 	<ul style="list-style-type: none"> 0 Decimal 1 24-hour clock mode Hours: Minutes: Seconds (6-digit version only) 2 12-hour clock mode (12:30 am is displayed as 12:30A. 12:30 pm is displayed as 12:30P) 3 24-hour clock mode Days: Hours:Minutes (6-digit version only) 4 - 5 - 6 - 7 Octal 	<ul style="list-style-type: none"> 0 No decimal point 1 -XX.XX.XX 2 - X.XXXXX 3 X.XXXXX 4 X.XXX 5 X.XX 6 X.X 7 Decimal Point set from the rear (X.XXXX to XXXXX) See Note 3. Also See Note 4.

Note: Selecting 1, 2, or 3 in the 2nd digit of this mode configures the display of the selected channel as a clock.

Note 2: These options are only for use with meters that have more than one display. With bargraph meters the PRIMARY display is the digital display, and the SECONDARY display is the bargraph display.

Note 3: These functions are only available on selected input modules.

Note 4: If Code 1's display modes have been entered (second digit set to 5, 6, or 7), the display will cycle between Code 1 and the display functions mode each time the PROGRAM button is pressed. To leave the cycle, the Code 1 digits must be reset to any relevant function between [X00] to [X20]. This takes you into Code 2.

Select Data Source

Program the three digits to the required display function mode

Use the [] buttons to cycle through the Registers Menu and Registers (1 to 244) to select data source for displays, peak and valley, totalizers and analog output (also see page 40).

[100] [10] [1] [diSP] [rESLt] [Ch1] [Ch2] [Ch3] [Ch4]

[ArE] [VALEY] [PEAK] [tot_2] [tot_1]

Select Last Digit Text Character

Use the [] button to cycle through the menu, and the [] button to cycle back.

Text off

FIRST DIGIT	SECOND DIGIT	THIRD DIGIT
BARGRAPH DISPLAY SETTINGS	BARGRAPH DISPLAY FORMAT	BARGRAPH TYPE
<ul style="list-style-type: none"> 0 No Function 1 - 2 - 3 Set up Bar Scaling 	<ul style="list-style-type: none"> 0 Setpoints on Bar 1 Peak, Valley on Bar 2 - 3 - 4 Min/Max with setpoints (low end of bar = VALLEY, high end of bar = PEAK) 5 - 6 - 7 Bar Only (no setpoints on the bar) 	<ul style="list-style-type: none"> 0 Linear 1 Via linearization Table 1 2 - 3 Log - 10 Bar/Decade 4 Log - 20 Bar/Decade 5 Log - 25 Bar/Decade 6 Log - 33 Bar/Decade 7 Log - 50 Bar/Decade

Set Up Scaling for Logarithmic Bargraph

Reference: 99999, Bar Nominal: 100

3X3 [REF] [Bar_n] 100

OR 3X4, OR 3X5, OR 3X6, OR 3X7

Set Up Scaling for Linear Bargraph

Bar Low: 99999, Bar High: 99999, Bar Nominal: 99999

3X0 [Bar_L] [Bar_H] [Bar_n] 99999 99999 99999

OR 3X1, 49999, 49999, 49999

Note: Data source for the bargraph is set up in Code 1 [X51].

Configure Data Source Procedure

The following example procedure describes how to select the source of the data to be displayed for the third digit selection.

Example Procedure:

Configure the Primary Display with the display [diSP] as the data source by setting Code 1 to [X50]. See diagram at the bottom of the page for data source selection options.



Programming Tip

To enter the Main Programming Mode press the **P** and **▲** buttons at the same time. To exit and return to the operational display, press the **P** and **▼** buttons again at the same time.

At the end of any procedure (Step 8 in this procedure) the **P** must be pressed before the **P** and **▼** buttons are pressed, otherwise the meter returns to the operational display without saving the new settings.

Select Data Source

P SourC [off]

[100] [10] [1] ← [diSP] [rESLt] [Ch1]
 [200] [Ch2]
 [244] [Ch3]
 [rArE] [VALEy] [PEAK] [tot_2] [tot_1] [Ch4]

Use the **▲** **▼** buttons to cycle through the Registers Menu and Registers (1 to 244) to select data source for displays (also see page 40).

START HERE

CONFIGURE DATA SOURCE

Step 1
Enter Brightness Mode

Step 2
Pass Brightness and Calibration Modes and enter Code 1

Step 3
Set Code 1 to [X50]:
1st Digit = X Note relevant
2nd Digit = 5 Selects data source mode
3rd Digit = 0 Selects primary display

Step 4

Step 5
Select [diSP] as the Data Source from the options listed in the Select Data Source diagram below.

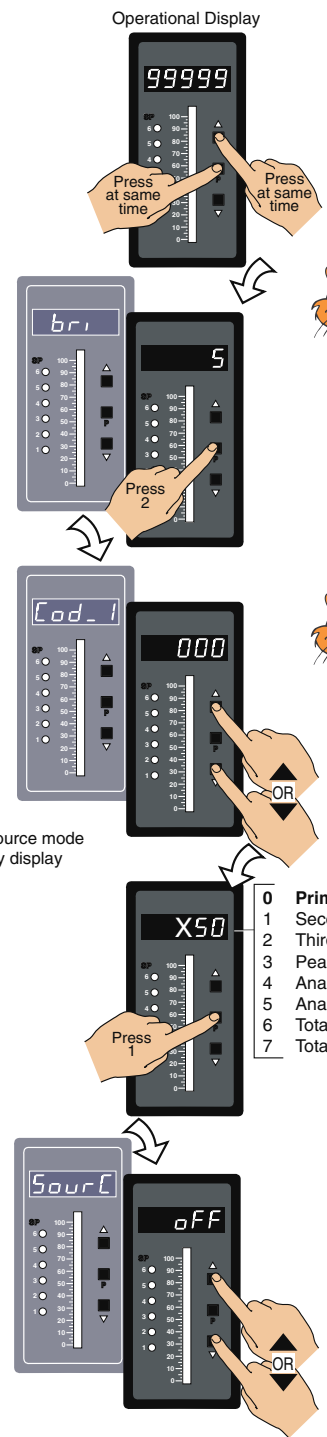

- 0 Primary Display
- 1 Second Display (See Note)
- 2 Third Display (See Note)
- 3 Peak/Valley
- 4 Analog Output 1
- 5 Analog Output 2
- 6 Totalizer 1
- 7 Totalizer 2

From Step 5

Step 6

Programming Tip
Pressing the **▼** button reaches [000] faster.

Step 7
Select [000] to leave Code 1

Programming Tip
Pressing the **▲** and **▼** buttons at the same time increases the displayed parameter in increments of 100 counts.

Step 8
Save Data Source setting

Step 9
Exit Code 2. Return to Operational Display

Note:
Options 1 and 2 listed for the 3rd digit in Step 3 above are only for use with meters that have more than one display. With bargraph meters the PRIMARY display is the digital display, and the SECONDARY display is the bargraph display.

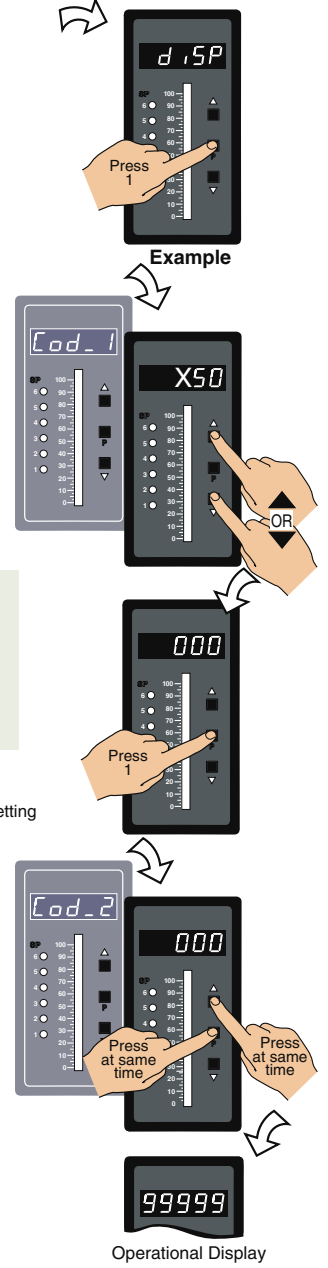

Configure Display Format Mode Procedure

The following example procedure describes how to configure the display format mode for the third digit selection and covers:

- Last Digit Rounding.
- Display Units.
- Decimal Point Placement.

Example Procedure:

Configure the display format mode for channel 1 with rounding by 2's, decimal display units, and the decimal point placed between display digits 4 and 5 by setting Code 1 to [X61].

Display Format Mode

Program the three digits to the required display format mode

FIRST DIGIT LAST DIGIT ROUNDING	SECOND DIGIT DISPLAY UNITS	THIRD DIGIT DECIMAL POINT PLACEMENT
0 No rounding	0 Decimal	0 No decimal point
1 Rounding by 2's	1 24-hour clock mode Hours: Minutes: Seconds (6-digit version only)	1 -XX.XX.XX
2 Rounding by 5's	2 12-hour clock mode (12:30 am is displayed as 12:30A. 12:30 pm is displayed as 12:30P)	2 - X.XXXXXX
3 Rounding by 10's	3 24-hour clock mode Days: Hours:Minutes (6-digit version only)	3 X.XXXXX
	4 -	4 X.XXX
	5 -	5 X.XX
	6 -	6 X.X
	7 Octal	7 Decimal Point set from the rear (X.XXXX to XXXXX) See Note 3 on page 20. Also See Note 4 on page 20.

Note: Selecting 1, 2, or 3 in the 2nd digit of this Mode configures the display of the selected channel (see Step 4) as a clock.

START HERE
CONFIGURE DISPLAY FORMAT

Step 1
Enter Brightness Mode

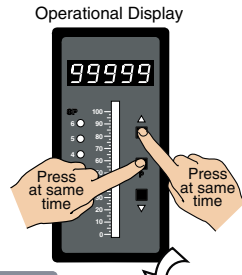

Step 2
Pass Brightness and Calibration Modes and enter Code 1

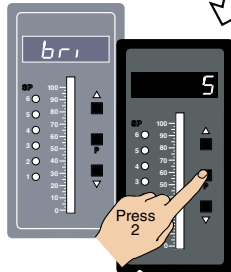

Step 3
Set Code to [X61]:
1st Digit = X Note relevant
2nd Digit = 6 Selects display functions
3rd Digit = 1 Selects Channel 1

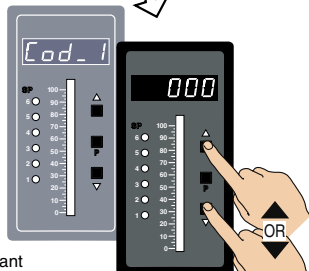

Step 4

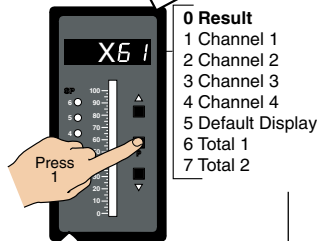

Step 5
Select the following Display Format from the three digits listed in the diagram above:

- 1st Digit = 1 Rounding by 2's
- 2nd Digit = 0 Decimal display
- 3rd Digit = 6 Decimal point

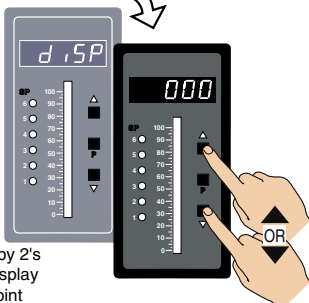

From Step 5

Step 6

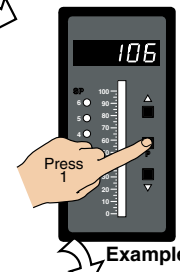

Step 7
Select [000] to leave Code 1

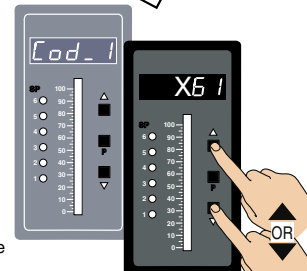

Step 8
Save Display Functions setting



Step 9
Exit Code 2. Return to Operational Display

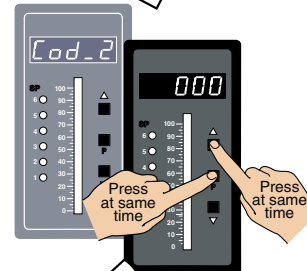

Operational Display

Configure Last Digit Text Character Procedure

The following example procedure describes how to select the last digit text character.

Example Procedure:

Configure Channel 1 with C as its last digit text character (for °C) by setting Code 1 to [X71]. See diagram opposite.

Select Last Digit Text Character



Use the button to cycle through the menu, and the button to cycle back.

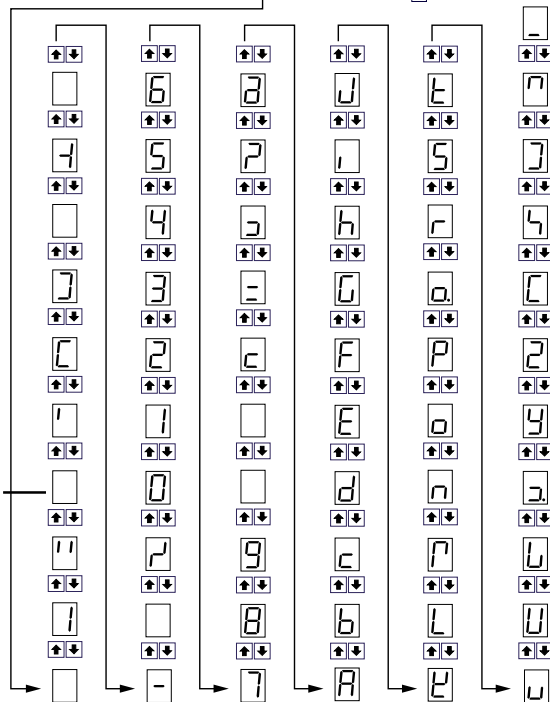

Press the Up or Down button 4 times as the next 4 characters are blank.

START HERE

CONFIGURE LAST DIGIT TEXT CHARACTER

Step 1

Enter Brightness Mode

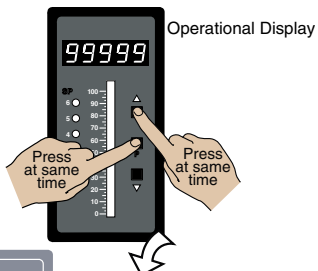

Step 2

Pass Brightness and Calibration Modes and enter Code 1

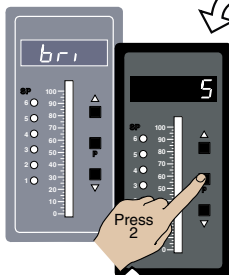

Step 3

Set Code to [X71]:
1st Digit = X Note relevant
2nd Digit = 7 Selects text character mode
3rd Digit = 1 Selects channel 1

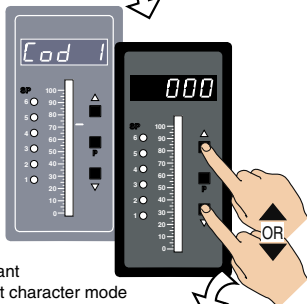

Step 4

- 0 Result
- 1 Channel 1
- 2 Channel 2
- 3 Channel 3
- 4 Channel 4
- 5 Default Display
- 6 Total 1
- 7 Total 2

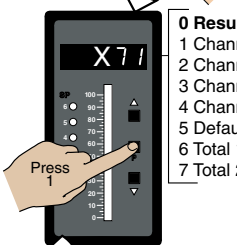

Step 5

Select Text Character [C] from the options listed in the diagram above

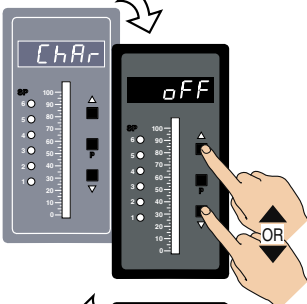

Step 6

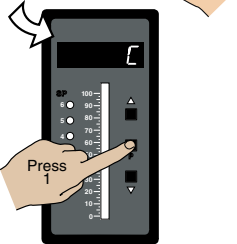

Example

From Step 6

Step 7

Select [000] to leave Code 1

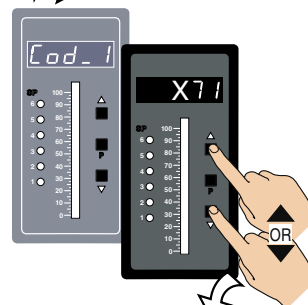

Step 8

Save Last Digit Text Character setting

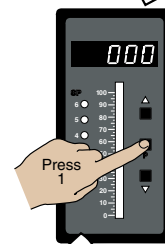

Step 9

Exit Code 2. Return to Operational Display

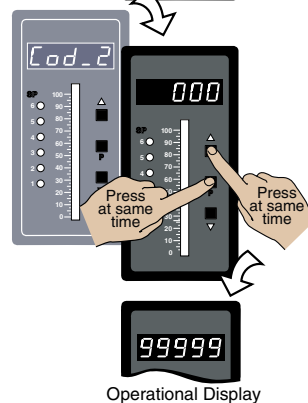

Configure Setpoint Annunciators Procedure

The following example procedure describes how to configure setpoint annunciators.

Example Procedure:

Configure the setpoint annunciators to come ON when the setpoints are OFF (not active) by setting Code 1 to [1XX].

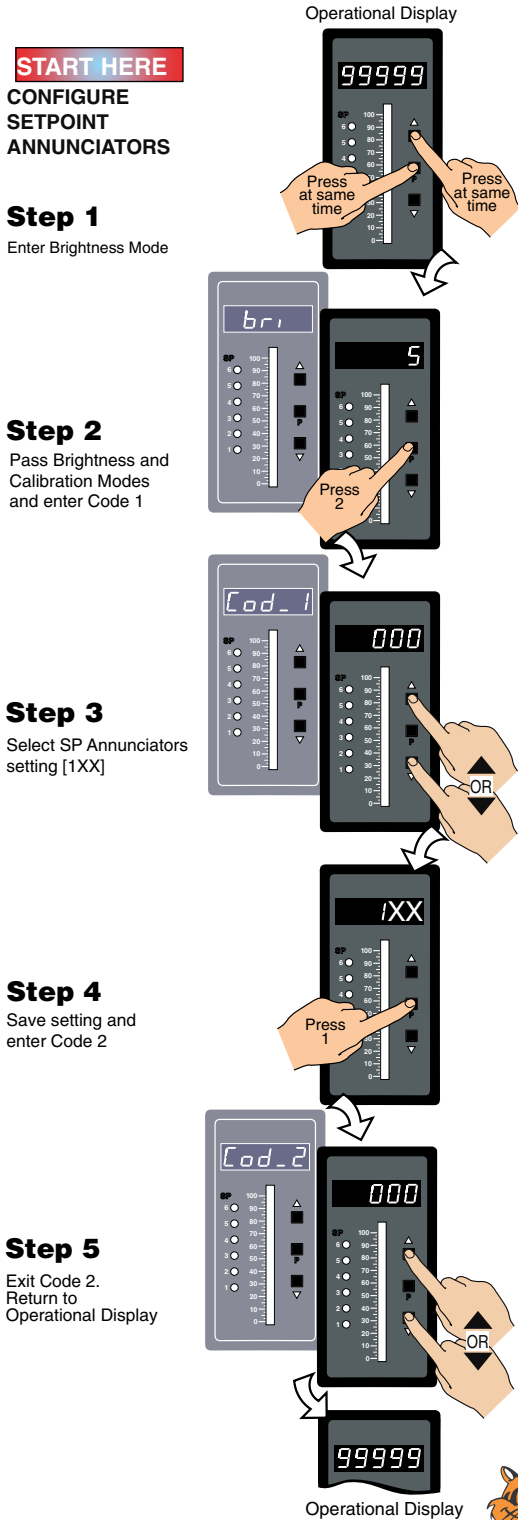

Configure Update at Sample Rate Procedure

The following example procedure describes how to configure the display to update at the sample rate selected in Code 2.

Example Procedure:

Update the display at the sample rate selected in Code 2 by setting Code 1 to [X2X].

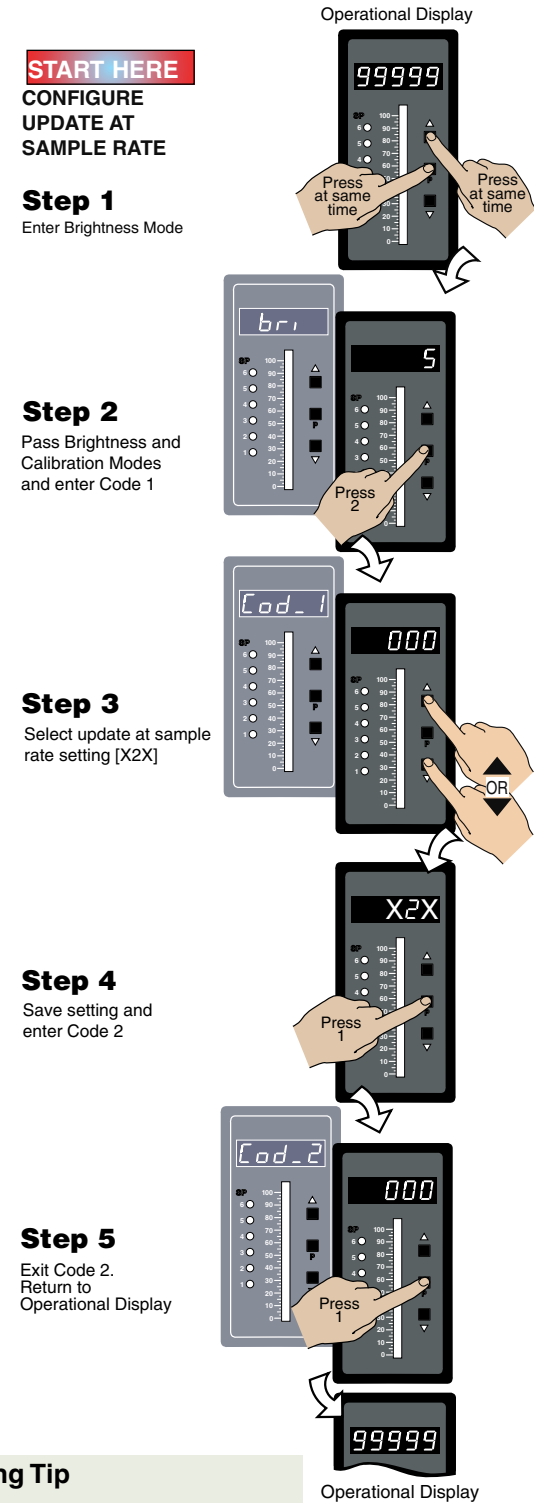

Programming Tip

The *Configuring Setpoint Annunciators* and the *Update at Sample Rate* procedures can be combined so that Code 1 could be set to [12X] (for the above examples) in a single procedure.



Scale Bargraph using Linear Scaling Procedure

START HERE

CONFIGURE BARGRAPH LINEAR SCALING

Step 1

Enter Brightness Mode

Operational Display

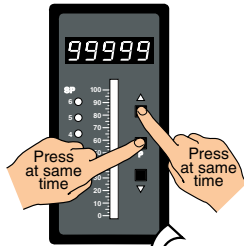

Step 2

Pass Brightness and Calibration Modes and enter Code 10

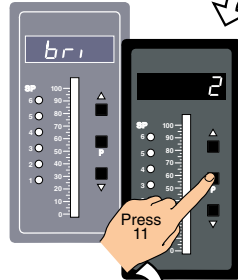

Step 3

Set Code 10 to [3X0]:
 1st Digit = 3 Set Up Bar Scaling
 2nd Digit = X Not relevant
 3rd Digit = 0 Linear

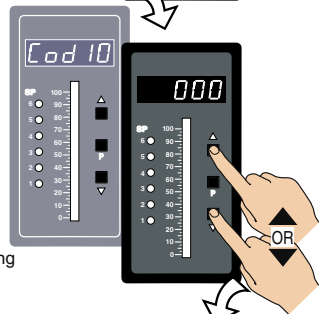

Step 4

Enter the bar low mode



Step 5

Adjust the display to the required bar low [bAr_L] setting

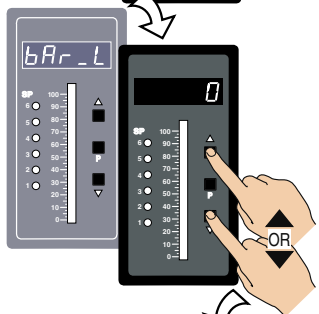

Step 6

Save [bAr_L] setting and enter bar high mode

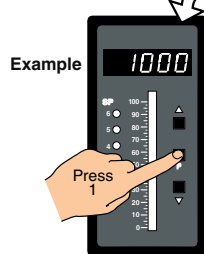

From Step 6

Step 7

Adjust the display to the required bar high [bAr_h] setting

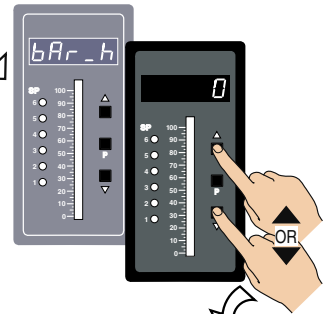

Step 8

Save [bAr_h] setting and enter bar nominal mode

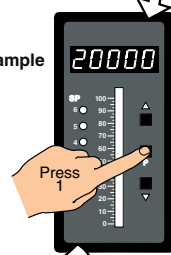

Step 9

Adjust the display to the required bar nominal [bAr_n] setting

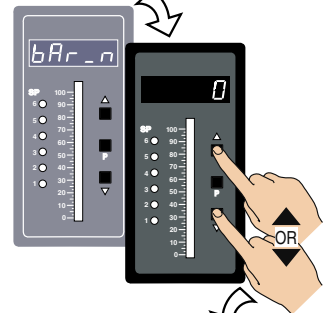

Step 10

Save the [bAr_n] setting and return to Code 10 menu

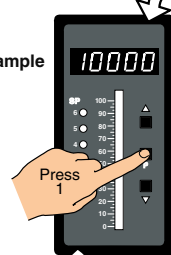

Step 11

Select bargraph display format. Set Code 10 to [0X0]:
 1st Digit = 0 No function
 2nd Digit = X Select display format
 3rd Digit = 0 Linear

- 0 Setpoints on Bar
- 1 Peak, valley on Bar
- 2 -
- 3 -
- 4 MIN/MAX with setpoints
- 5 -
- 6 -
- 7 Bar only (No setpoints on bar)

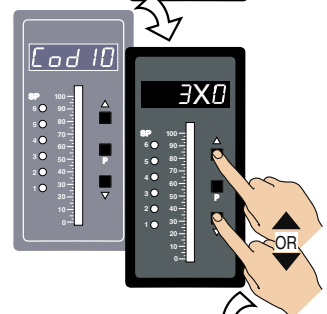

Step 12

Exit Code 10. Return to the Operational Display

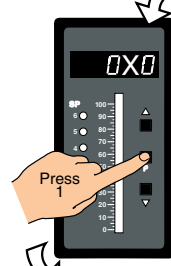

Operational Display

Scale Bargraph using Logarithmic Scaling Procedure

START HERE

CONFIGURE BARGRAPH LOGIRITHMIC SCALING

Step 1

Enter Brightness Mode

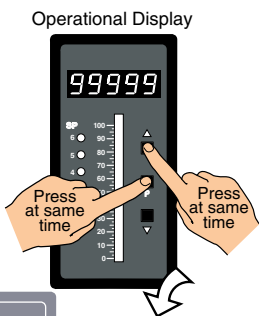

Step 2

Pass Brightness and Calibration Modes and enter Code 10

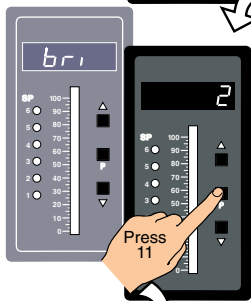

Step 3

Set Code 10 to [3X3]:
 1st Digit = 3 Set Up Bar Scaling
 2nd Digit = X Not relevant
 3rd Digit = 3 Log - 10 Bar/Decade

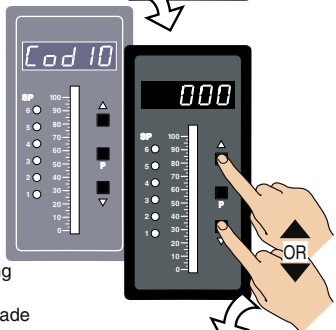

Step 4

Enter the reference [rEF] mode

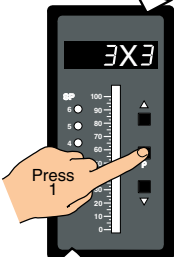

Step 5

Adjust the display to the required reference [rEF] setting

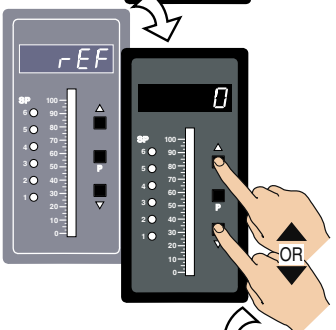

Step 6

Save [rEF] setting and enter bar nominal mode

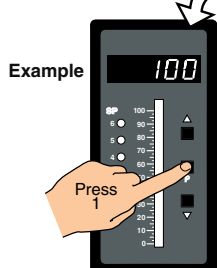

From Step 6

Step 7

Adjust the display to the required bar nominal [bAr_n] setting

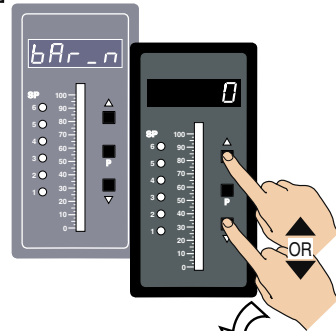

Step 8

Save [bAr_n] setting and return to Code 10

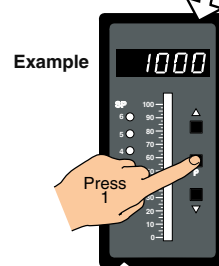

Step 9

Select bargraph display format. Set Code 10 to [0X0]:
 1st Digit = 0 No function
 2nd Digit = X Select display format
 3rd Digit = 3 Log-10 Bar

- 0 Setpoints on Bar
- 1 Peak, valley on Bar
- 2 -
- 3 -
- 4 MIN/MAX with setpoints
- 5 -
- 6 -
- 7 Bar only (No setpoints on bar)

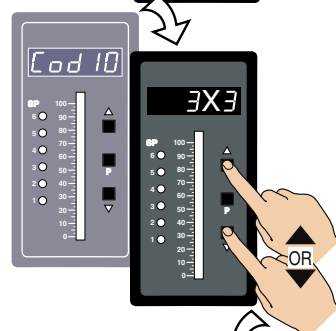

Step 10

Exit Code 10. Return to the Operational Display

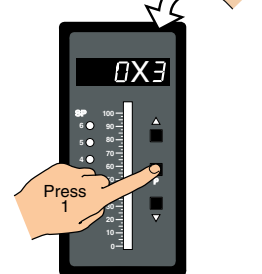

To Step 7

[Code 2] - Channel 1 Measurement Task & Sampling Rate

The Tiger 320 Series DI-50B51 meter can be configured to measure almost any input signal. The measurement task and sampling rate for Channel 1 (CH1) is configured in the three digits of Code 2. The diagram below lists the available configuration selections in Code 2.

Example Procedure:

Configure CH1 for a voltage input with 10 samples/second (60 Hz rejection) sampling rate and output rate of 0.1 seconds by setting Code 2 to [000].

FIRST DIGIT	SECOND DIGIT	THIRD DIGIT
CODE 2 – CHANNEL 1 MEASUREMENT TASK AND SAMPLING RATE		
ANALOG SAMPLE RATE	MEASUREMENT TASK	FOR VOLTAGE
0 Sample Rate: Typically 10 samples/second (60 Hz) Output Rate: 0.1 seconds See Example	0 Voltage, Current 1 TC (3rd digit selects type of TC) 2 RTD 3-wire (3rd digit selects type of RTD) 3 RTD 2- or 4-wire (3rd digit selects type of RTD) 4 Frequency 5 Period 6 Counter 7 Smart Input Module	0 No function 1 Peak detector 2 Pressure with Auto-cal
1 Sample Rate: Typically 10 samples/second (50 Hz) Output Rate: 0.1 seconds See Example		FOR THERMOCOUPLE
2 Sample Rate: Typically 10 samples/second (60 Hz) Output Rate: 10 milliseecs See Example		0 Type J 1 Type K 2 Type R 3 Type S 4 Type T 5 Type B 6 Type N 7 Select user defined table set up in CAL [24X]
3 Sample Rate: Typically 10 samples/second (50 Hz) Output Rate: 10 milliseecs See Example		FOR RTD TYPE (2-, 3-, 4- WIRE)
Note: Output Rate refers to setpoint and macro outputs, and input rates from smart input modules.		0 Resistance 1 RTD 385 2 RTD 392 3 RTD 120 4 Cn 10
Note: All above sample rates are quoted for single channel operation. Where more than one channel is available, sample rates are divided by the number of active channels. See Example.	Example: 10 Samples/Second	FREQUENCY RANGE
	1 Channel = 10 samples/second 2 Channels = 5 samples/second 3 Channels = 3.33 samples/second 4 Channels = 2.5 samples/second	0 99.999 Hz range from 0.010 Hz 1 99.999 Hz range from 2.000 Hz 2 999.99 Hz range from 0.01 Hz 3 999.99 Hz range from 2.00 Hz 4 9999.9 Hz range from 0.1 Hz 5 9999.9 kHz range from 2.0 Hz 6 99 kHz range from 1 Hz (1 s gate) 7 655.35 kHz range from 10 Hz (0.1 s gate)
		PERIOD MEASUREMENT
		0 99.999 s 1 9.9999 s 2 999.99 ms 3 99.999 ms
		COUNTER/RESIDENT TIMER/CLOCK
		0 Counter input with 16 bit Pre-scaler 1 Setting of 16-bit Pre-scaler 2 Debounced Counter with Pre-scaler 3 Up/Down Counter with Pre-scaler 4 0.1 sec Timer with Pre-scaler 5 - 6 External 24-hour clock 7 Internal 24-hour clock
		SMART INPUT MODULE
		0 Output Register 1 1 Output Register 2 2 Output Register 3 3 Output Register 4 4 Output Register 5 5 Output Register 6 6 Output Register 7 7 Smart Input Module Setup.

START HERE

CONFIGURE CH1 MEASUREMENT TASK & SAMPLING RATE

Step 1

Enter Brightness Mode



Step 2

Pass Brightness Mode, Calibration Mode, Code 1, and enter Code 2

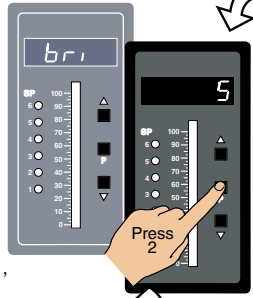

X61 Sets Prescaler	
1 =	0.1 second
10 =	1 second
600 =	1 minute
36000 =	1 Hour

***Note: For the 1 hour setting, the scale factor for CH1 must be set to 0.1 in the calibration mode setting [111].

Step 3

Set Code 2 to [000]:
 1st Digit = 0 Selects 10 samples/sec (60 Hz)
 2nd Digit = 0 Selects voltage, current
 3rd Digit = 0 Selects no function

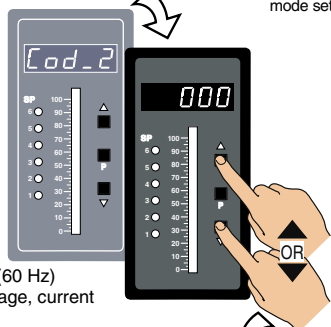

Step 4

Save setting and enter Code 3

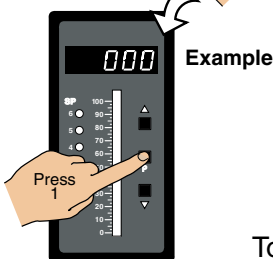

Step 5

Exit Code 3. Return to Operational Display

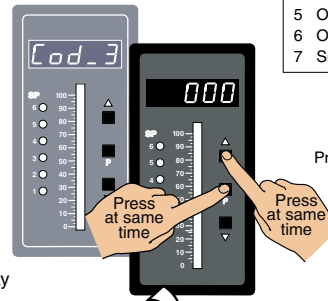

Press **0** **577E1** **000**

Use the **↑** **↓** buttons to set the required smart input module code (0 to 377). See I-Series Input Module Guide (Z87) for code details.

To Step 5

Operational Display

[CodE 3] - Channel 1 Post Processing & Serial Mode Functions

Post processing functions refer to functions that occur to the input after it has been configured and scaled.

Post processing for Channel 1 (CH1) is configured in the first digit of Code 3. The diagram below lists the available post processing configuration selections in Code 3 (1st digit only).

FIRST DIGIT
CH1 POST PROCESSING
0 Direct Display of Input (no processing)
1 Square Root of Channel 1
2 Inverse of Channel 1
3 -

SECOND DIGIT
CODE 3 – CHANNEL 1 FUNCTIONS (POST PROCESSING & SERIAL MODE)
32-POINT LINEARIZATION FOR CHANNEL 1
0 No Linearization on CH1
1 32-point Linearization on CH1 using Table 1
2 32-point Linearization on CH1 using Table 2. See Note 5
3 32-point Linearization on CH1 using Table 3. See Note 5
4 32-point Linearization on CH1 using Table 4. See Note 5
5 125-point Linearization on CH1 (Tables 1 to 4 cascaded). See Note 5
6 32-point Linearization on CH1 (Tables 1 to 4 selected from the rear pins of selected input modules). The selected table is not available if CH2, CH3, or CH4 is operating in the analog output mode. CH1 must be set to Voltage, Current in Code 2 [X0X]. See Note 5
7 -

Note:
All linearization tables are set up in the Calibration Mode [24X].

THIRD DIGIT
SERIAL MODE
0 ASCII Mode
1 Modbus Mode
2 Master mode (used to customize print mode protocols via macro)
3 Print Mode
4 Ethernet Mode. See Note 6
5 Devicenet Mode (No longer supported).

Note 5:
If only 4 kB memory installed, functions 2 to 6 are not available in:

- Code 3 second digit.
- Code 4 third digit.
- Code 7 second digit.

Note 6:
These functions are not available on all models and in some cases require additional hardware.

START HERE

CONFIGURE CH1 POST PROCESSING FUNCTIONS

Step 1

Enter Brightness Mode

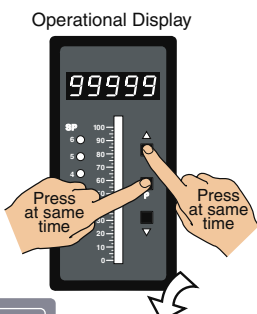

Step 2

Pass Brightness Mode, Calibration Mode, Code 1, and enter Code 2

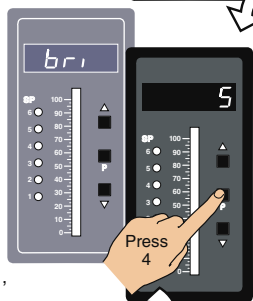

Step 3

Set Code 3 to [100]:
1st Digit = 1 Square root of CH1
2nd Digit = 0 No linearization
3rd Digit = 0 ASCII Mode

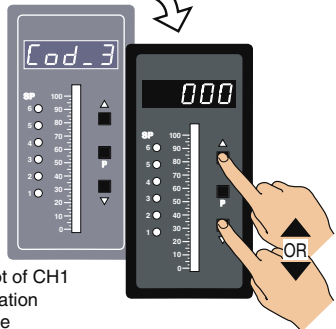

Example Procedure:

Configure the meter to apply square root to the CH1 signal by setting Code 3 to [100].

From Step 3

Step 4

Save Post Processing setting



Step 5

Exit Code 4. Return to Operational Display

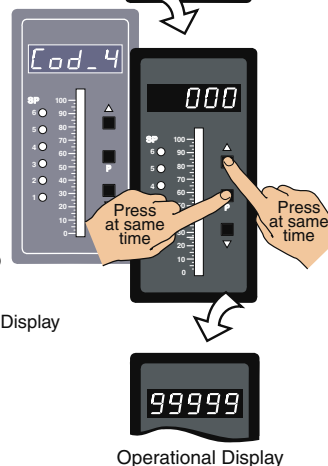

Programming tip

For full details on the Serial Mode, see *Serial Communications Output Module* supplement.

Print Mode – Data Printing Direct to Serial Printer

Print mode data logging is a simple method of capturing data using the meter's print mode. The data can be printed directly to a serial printer from the meter.

The print mode uses the meter's serial communications port to connect to a remote serial printer. The data can be printed with or without a Day: Month: Year or Hours: Minutes: Seconds time stamp.

Time stamp settings are configured in Code 8.

Print Mode – Data Printing Direct to PC

The print mode can also be used to print data to a PC where it is logged in a Windows Terminal program.

The print mode uses the meter's serial communications port to connect to the PC. The data can be logged with or without a Day: Month: Year or Hours: Minutes: Seconds time stamp.

Time stamp settings are configured in Code 8.

[CodE 4] - Channel 2 Measurement Task & Sampling Rate

Code 4 is a single code that combines all the configuration and post processing functions available for Channel 2.

When a **dual input** signal conditioner is installed, the second input signal is processed and displayed on CH2.

Measurement task and 32-point linearization for CH2 is configured in the 1st and 2nd digits of Code 4. The diagram opposite lists the available configuration selections in Code 4.

Example Procedure:

Configure CH2 for a voltage input with no linearization by setting Code 4 to [010].

See *I-Series Input Modules Guide (Z87)* for procedures to set up a dual input module.

FIRST DIGIT	SECOND DIGIT	THIRD DIGIT
CODE 4 – CHANNEL 2 MEASUREMENT TASK AND 32-POINT LINEARIZATION		
MEASUREMENT TASK	FOR VOLTAGE & CURRENT	32-POINT LINEARIZATION FOR CH2
0 Voltage, Current	0 Channel 2 Disabled	0 No user defined Linearization on CH2
1 TC (type as per 2nd digit)	1 Direct (no post processing)	1 32-point Linearization on CH2 using Table 1
2 RTD (type as per 2nd digit)	2 Square Root of Channel 2	2 32-point Linearization on CH2 using Table 2. See Note 5
3 Second Digital Input Channel (type as per 2nd digit)	3 Inverse of Channel 2	3 32-point Linearization on CH2 using Table 3. See Note 5
	4 Output Register 1 (smart module)	4 32-point Linearization on CH2 using Table 4. See Note 5
	5 Output Register 2 (smart module)	5 125-point Linearization on CH2 (Tables 1 to 4 cascaded). See Note 5
	6 Output Register 3 (smart module)	6 –
	7 Output Register 4 (smart module)	7 –
	FOR THERMOCOUPLE	
	0 Type J	
	1 Type K	
	2 Type R	
	3 Type S	
	4 Type T	
	5 Type B	
	6 Type N	
	7 Select user defined table set up in CAL [24X]	
	FOR RTD TYPE (3-WIRE)	
	0 Resistance	
	1 RTD 385	
	2 RTD 392	
	3 RTD 120	
	4 Cn10	
	DIGITAL INPUT	
	0 Frequency - 99.999 Hz range from 0.01 Hz	
	1 Frequency - 999.99 Hz range from 0.01 Hz	
	2 Frequency - 99.999 kHz range from 1 Hz (1 s gate)	
	3 Frequency - 500 kHz range from 10 Hz (0.1 s gate)	
	4 Period - 9.9999 s (100 μs resolution)	
	5 Period - 999.99 ms (10 μs resolution)	
	6 Up/Down Counter with Prescaler	
	7 Set Prescaler	

Note 5:
If only 4 kB memory installed, functions 2 to 6 are not available in:

- Code 3 second digit.
- Code 4 third digit.
- Code 7 second digit.

START HERE

CONFIGURE CH2 MEASUREMENT TASK

Step 1
Enter Brightness Mode

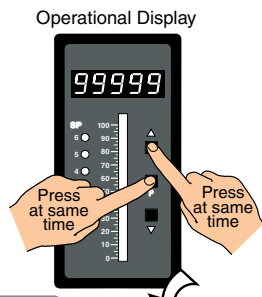

Step 2
Pass Brightness Mode, Calibration Mode, and Codes 1 to 3, and enter Code 4

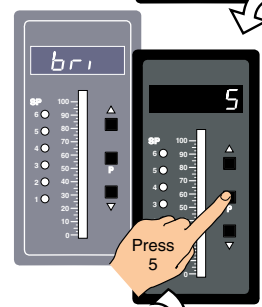

Step 3
Set Code 4 to [030]:
1st Digit = 0 Selects voltage, current
2nd Digit = 1 Selects direct
3rd Digit = 0 Selects no linearization

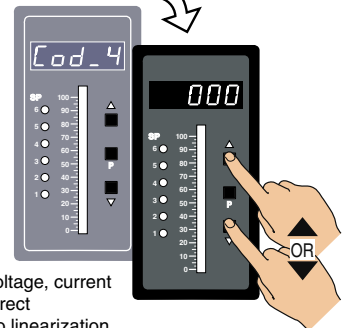

From Step 3

Step 4
Save CH2 Measurement Task setting



Step 5
Exit Code 5. Return to Operational Display

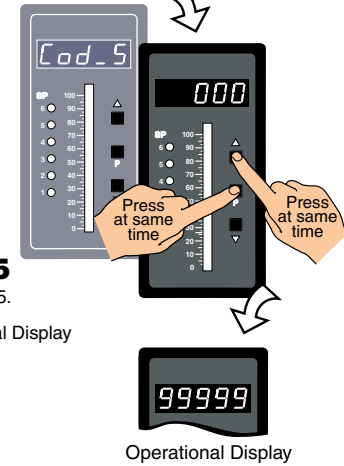

Use buttons to set prescale values from 1 to 65535 counts

[Code 5] - Channel 3 Functions

Code 5 is a single code that combines all the configuration and post processing functions available for Channel 3.

When a **triple input** signal conditioner is installed, the third input signal is processed and displayed on CH3.

Post processing and measurement task functions for CH3 are configured in the 1st, 2nd, and 3rd digits of Code 5. The diagram opposite lists the available configuration selections in Code 5.

FIRST DIGIT	SECOND DIGIT	THIRD DIGIT
CODE 5 – CHANNEL 3 FUNCTIONS		
CH3 POST PROCESSING	MEASUREMENT TASK	FOR THERMOCOUPLE
0 Direct Display of Input (no processing)	0 No Function	0 Type J
1 Square Root of Channel 3	1 Voltage / current	1 Type K
2 Inverse of Channel 3	2 TC (3rd digit selects type of TC)	2 Type R
3 4 kB Meters 32-point Linearization of CH3 using Table 1	3 RTD (3rd digit selects type of RTD)	3 Type S
4 kB Meters 32-point Linearization of CH3 using Table 3	4 Real Time Clock & Timer (3rd digit selects type)	4 Type T
Note: All linearization tables are set up in the Calibration Mode [24X].	5 -	5 Type B
	6 -	6 Type N
	7 Smart Input Module (3rd digit selects register)	7 Select user defined linearization table (Table 1) set up in CAL [24X]
		FOR RTD TYPE (2-, 3-, 4- WIRE)
		0 Resistance
		1 RTD 385
		2 RTD 392
		3 RTD 120
		4 Cn 10
		FOR REAL-TIME CLOCK & TIMER
		0 HRS:MIN:SEC
		1 HRS:MIN
		2 -
		3 -
		4 1 Second Count UP Timer
		5 1 Second Count DOWN Timer
		6 -
		7 -
		FOR SMART INPUT MODULE
		0 Output Register 1
		1 Output Register 2
		2 Output Register 3
		3 Output Register 4
		4 Output Register 5
		5 Output Register 6
		6 Output Register 7
		7 Smart Input Module Register 2 Code Setup

Example Procedure:

Configure CH3 to display the square root of a voltage input by setting Code 5 to [11X].

See *I-Series Input Modules Guide (Z87)* for procedures to set up a triple input module.

START HERE

CONFIGURE CH3 FUNCTIONS

Step 1

Enter Brightness Mode

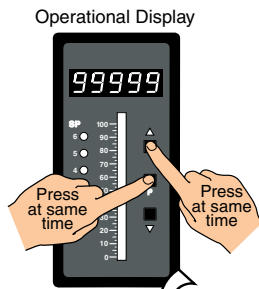

Step 2

Pass Brightness Mode, Calibration Mode, and Codes 1 to 4 and enter Code 5

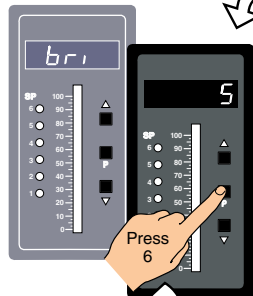

Step 3

Set Code 5 to [11X]:
 1st Digit = 1 Selects square root of CH3
 2nd Digit = 1 Selects voltage, current
 3rd Digit = X Not relevant

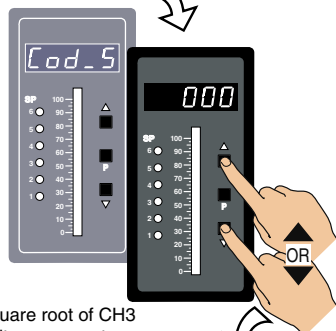

Step 4

Save CH3 setting

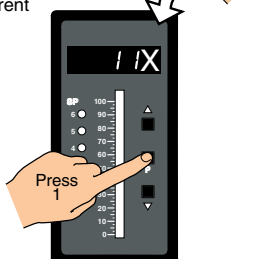

Press **P** **Smart** **000** Use the **↑****↓** buttons to set the required smart input module code (0 to 377). See *I-Series Input Modules Guide (Z87)* for code details.

Step 5

Exit Code 6. Return to Operational Display

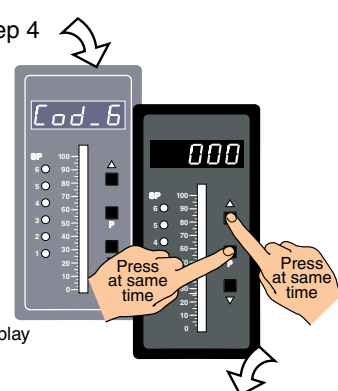

Operational Display

[CodE 6] - Channel 4 Functions

Code 6 is a single code that combines all the configuration and post processing functions available for Channel 4.

When a **quad input** signal conditioner is installed, the fourth input signal is processed and displayed on CH4.

Post processing and measurement task functions for CH4 are configured in the 1st, 2nd, and 3rd digits of Code 6. The diagram opposite lists the available configuration selections in Code 6.

Example Procedure:

Configure CH4 as direct display of voltage input by setting Code 6 to [01X].

See I-Series Input Modules Guide (Z87) for procedures to set up a quad input module.

FIRST DIGIT	SECOND DIGIT	THIRD DIGIT
CODE 6 – CHANNEL 4 FUNCTIONS		
CH4 POST PROCESSING	MEASUREMENT TASK	FOR THERMOCOUPLE
0 Direct Display of Input (no processing)	0 No Function	0 Type J
1 Square Root of Channel 4	1 Voltage / Current	1 Type K
2 Inverse of Channel 4	2 TC (3rd digit selects type of TC). See Note 7	2 Type R
3 4 kB Meters 32-point Linearization of CH4 using Table 1	3 RTD (3rd digit selects type of RTD). See Note 7	3 Type S
32 kB Meters 32-point Linearization of CH4 using Table 4	4 Real Time Clock and Timer (3rd digit selects type)	4 Type T
<i>Note:</i> All linearization tables are set up in the Calibration Mode [24X].	5 -	5 Type B
	6 -	6 Type N
	7 Smart Input Module (3rd digit selects register)	7 Select user defined linearization table (Table 1) set up in CAL [24X]
		FOR RTD TYPE (2-, 3-, 4- WIRE)
		0 Resistance
		1 RTD 385
		2 RTD 392
		3 RTD 120
		4 Cn 10
		FOR REAL-TIME CLOCK & TIMER
		0 HRS:MIN:SEC
		1 HRS:MIN
		2 -
		3 -
		4 1 Second Count UP Timer
		5 1 Second Count DOWN Timer
		6 -
		7 -
		FOR SMART INPUT MODULE
		0 Output Register 1
		1 Output Register 2
		2 Output Register 3
		3 Output Register 4
		4 Output Register 5
		5 Output Register 6
		6 Output Register 7
		7 Smart Input Module Register 3 Code Setup

Note: 7
For future development.

START HERE

CONFIGURE CH4 FUNCTIONS

Step 1
Enter Brightness Mode

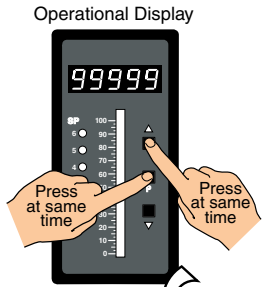

Step 2
Pass Brightness Mode, Calibration Mode, and Codes 1 to 5 and enter Code 6

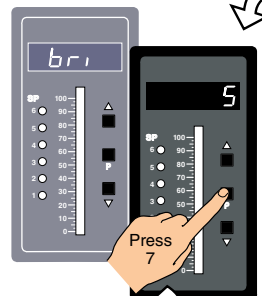

Step 3
Set Code 6 to [01X]:
1st Digit = 2 Selects inverse of CH4
2nd Digit = 1 Selects voltage, current
3rd Digit = X Not relevant

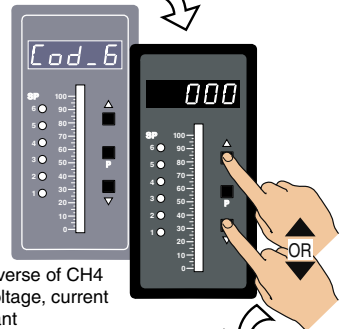

Step 4
Save CH4 setting

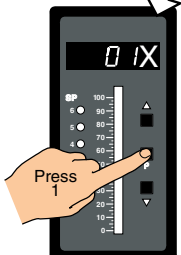

Press **P** **577rE** **000** Use the **↑****↓** buttons to set the required smart input module code (0 to 377). See *I-Series Input Modules Guide (Z87)* for code details.

Step 5
Exit Code 7. Return to Operational Display



The 3rd digit of Code 7 performs various math functions between channel 1 and channel 2 and stores this data in the result register.

The data in the result register can then be further processed by the selections made in the 1st and 2nd digits.

FIRST DIGIT	SECOND DIGIT	THIRD DIGIT
CODE 7 – RESULT PROCESSING		
RESULT PROCESSING	32-POINT LINEARIZATION FOR RESULT	MATHS FUNCTIONS FOR RESULT
0 Direct Display of Result as per processing performed in 2nd or 3rd digit 1 Square Root of Result 2 Inverse of Result 3 -	0 No Linearization on Result 1 32-point Linearization on Result using Table 1 2 32-point Linearization on Result using Table 2. See Note 5 3 32-point Linearization on Result using Table 3. See Note 5 4 32-point Linearization on Result using Table 4. See Note 5 5 125-point Linearization on Result (Tables 1 to 4 cascaded). See Note 5 6 32-point Linearization on Result (Tables 1 to 4 selected from the rear of the meter). The selected table is not available if CH2, CH3, or CH4 is operating in the analog mode. CH1 must be set to Voltage, Current in Code 2 [X0X]. See Note 5 7 -	0 Result Register not Updated 1 pH Meter (CH1 = Tbuff, CH2 = pH) 2 Result = CH1, Setpoint 2 = CH2 3 Result = CH1 + CH2 4 Result = CH1 - CH2 5 Result = (CH1 x 20 000)/CH2 6 Result = CH1 x CH2/10 000 7 Result = CH1

Example Procedure:

Configure Code 7 to add the input of CH1 and CH2 and directly display the result by setting Code 7 to [003].

Note 5: If only 4 kB memory installed, functions 2 to 6 are not available in:

- Code 3 second digit.
- Code 4 third digit.
- Code 7 second digit.

See I-Series Input Modules Guide (Z87) for procedures to set up a dual, triple, or quad input module.

START HERE

CONFIGURE RESULT PROCESSING

Step 1

Enter Brightness Mode

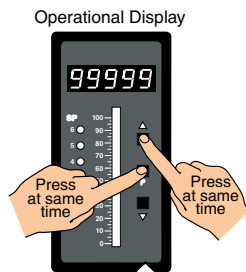

Step 2

Pass Brightness Mode, Calibration Mode, and Codes 1 to 6 and enter Code 7

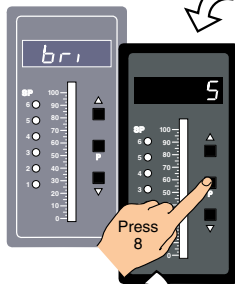

Step 3

Set Code 7 to [003]:
 1st Digit = 0 Selects direct display of result
 2nd Digit = 0 Selects no linearization on result
 3rd Digit = 3 Selects result = CH1+CH2

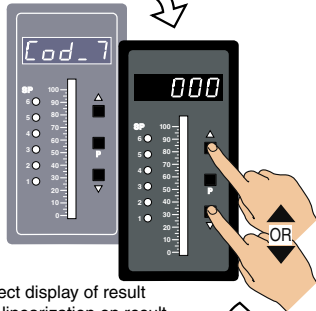

Step 4

Save CH1 & CH 2 Result Processing setting

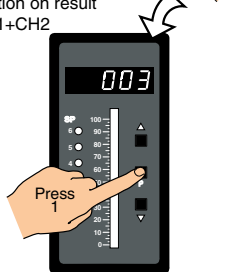

From Step 4

Step 5

Exit Code 8. Return to Operational Display

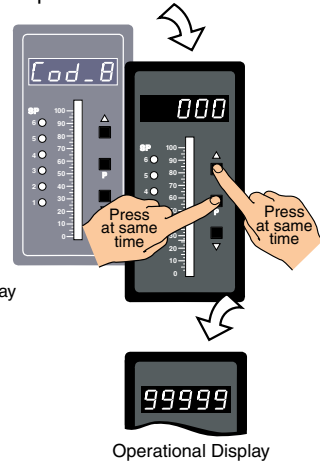

Linearization Table Notes

A base meter with 4 kB memory installed has a single 32-point programmable linearization table available.

For four 32-point programmable linearization tables to be available, the meter requires at least 32 kB of memory to be installed.

Meters with 4 kB Memory

In base meters with 4 kB memory, set up Table 1 in the Calibration Mode to [24X]. This means that Table 1 is available to be applied to:

- CH1 – Selected in Code 3.
- CH2 – Selected in Code 4.
- CH3 – Selected in Code 5.
- CH4 – Selected in Code 6.

Meters with 32 kB Memory

In base meters with 32 kB or more memory, each of the four tables (Tables 1 to 4) are set up in [24X] of the Calibration Mode by selecting the appropriate table number. This means that the four tables are available for the four channels as follows:

- CH1 – All four tables selected in Code 3.
- CH2 – All four tables selected in Code 4.
- CH3 – Table 3 selected in Code 5.
- CH4 – Table 4 selected in Code 6.

[CodE 8] - Data Logging & Print Mode

Up to 4000 samples can be logged within the meter in the cyclic or linear FIFO mode and saved for later downloading to a PC, using a terminal evaluation program, or printing directly to a serial printer.

Data logging can be triggered (activated) from a setpoint, the program button, or from an external switch. See the 3rd digit in the diagram below.

Data from up to four selectable registers can be logged with one of the following printer or spreadsheet style time and date stamps. All time and date stamps are generated from an optional real-time clock (see the 2nd digit in the diagram below):

- No time stamp.
- Month - Day - Year. Hours:Minutes:Seconds.
- Day - Month - Year. Hours:Minutes:Seconds.
- Hours:Minutes:Seconds.

Printer style time and date stamps have a carriage return and line feed. Spreadsheet style time and date stamps are continuous on a single line.

See Serial Communications Module Supplement (NZ202) for full details on the Data Logging and Print Mode Options.

FIRST DIGIT	SECOND DIGIT	THIRD DIGIT
CODE 8 – DATA LOGGING AND PRINT MODE OPTIONS		
DATA LOG BUFFER TYPE	DATE & TIME STAMP OPTIONS	LOG OR PRINT TRIGGER
0 No Data Logging 1 Cyclic Buffer 2 Linear FIFO Buffer. 3 Reset Buffer Number to 0. <i>Note:</i> <i>Setting Code 8 to [3XX] resets the data log buffer to 0. Once reset, Code 8 must be set back to the required data log buffer setting.</i>	0 Printer Format – No time stamp with print/log 1 Printer Format – Time stamp format 1 [Mth-Day-Yr Hrs:Min:Sec] (with <CR><LF>) 2 Printer Format – Time stamp format 2 [Day-Mth-Yr Hrs:Min:Sec] (with <CR><LF>) 3 Printer Format – Time stamp format 3 [Hrs:Min:Sec] (with <CR><LF>) 4 Spreadsheet Format – No time stamp with print/log 5 Spreadsheet Format – Time stamp format 1 [Mth-Day-Yr Hrs:Min:Sec] 6 Spreadsheet Format – Time stamp format 2 [Day-Mth-Yr Hrs:Min:Sec] 7 Spreadsheet Format – Time stamp format 3 [Hrs:Min:Sec] ALL ABOVE ARE REAL-TIME CLOCK OPTIONS	0 No trigger 1 Trigger on Demand from PROGRAM Button 2 Trigger on Demand from F1 Button 3 Trigger on Demand from F2 Button 4 Trigger on Demand from HOLD Pin 5 Trigger on Demand from LOCK Pin 6 - 7 - <i>Note:</i> <i>Log and/or print will only trigger if enabled.</i>

[CodE 9] - Functions for Digital Input Pins

The TEST, HOLD, and LOCK pins are located at the rear of the meter to accommodate external switched digital inputs. When switched to the COMMON pin, they can be programmed in Code 9 to perform remote resetting functions to add to the functionality of the meter.

Note:

CAPTURE, HOLD, and LOCK pins can be a setpoint activation source. See Setpoint Programming mode.

FIRST DIGIT	SECOND DIGIT	THIRD DIGIT
CODE 9 – FUNCTIONS FOR DIGITAL INPUT PINS		
DISPLAY TEST PIN	HOLD PIN	LOCK PIN
0 Display test only 1 Reset Counter Channel 1 and Sub-total at Power-up 2 Reset Counters Channel 1, 2, 3, 4, Total 1, and Total 2 at Power-up 3 Reset Total 1, and Total 2 at Power-up	0 Display Hold 1 Reset Channel 1 2 Reset Total 1 and Total 2 3 Reset Total 2 4 Reset Peak, Valley 5 Reset Tare 6 Set Tare 7 Unlatch (de-energize) all Setpoints	0 Key Lock 1 Reset Channel 1 2 Reset Channel 2 3 Reset Channel 3 4 Reset Channel 4 5 Reset Tare 6 Reset Total 7 Unlatch (de-energize) all Setpoints

Setpoint Programming Mode

All setpoint activation and control settings are selected and configured using the front panel buttons in the **setpoint programming mode**. Or, software configured via the **meter configuration utility program** if the meter is connected to a PC through the serial port. The meter has six software driven setpoints, independently configured to operate within the total span range of the meter and the selected input module.

Relay Output Modules

Five standard relay output module options provide a selection of 20 relay configuration options for DI-50 meters.

Three electromechanical relay output modules support a combination of 4 / 5 A Form A and 9 / 10 A Form C relays providing 12 configuration options. A solid state relay (SSR) output module supports 300 V, 210 mA DC SSRs.

A 22 opto-isolated I/O plug-in module can support six inputs and up to 16 outputs. The standard plug-in module has six inputs and six outputs that can be extended to 16 outputs with a 10 output add-on board.

320 Series Relay Output Module Options

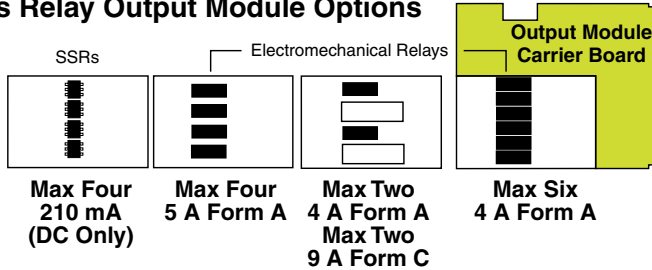

Optional Opto-isolated 22 I/O Plug-in Module

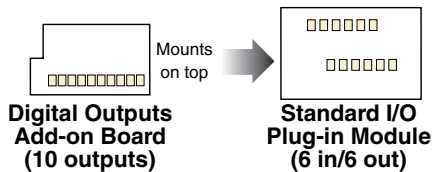

Setpoint Programming Mode

See the *Setpoint Programming Mode Logic Diagram* opposite.

The setpoint programming mode is entered by pressing the meter's **P** and **↓** buttons at the same time.

Setpoint Activation Values

Each setpoint activation value is individually programmed. Setpoint activation values can be set within the total span range of the meter and the selected input module.

Setpoint and Relay Control Settings

See the *Setpoint and Relay Control Settings diagram* on Pages 38 and 39.

The control settings provide access to the following setpoint and relay functions for configuration using the meter's 1st, 2nd, and 3rd digits:

- **1st Digit** – Relay Energize Functions.
- **2nd Digit** – Setpoint Activation Source.
- **3rd Digit** – Setpoint Delay, Timer, and Reset and Trigger Functions.

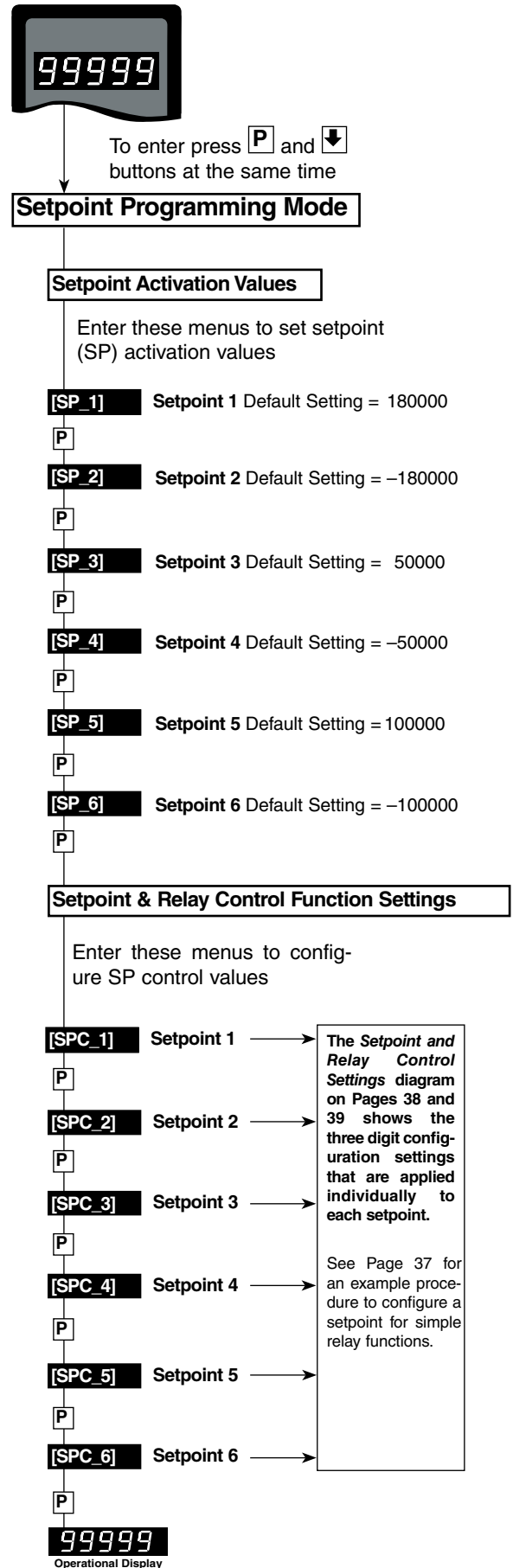

Setpoint Programming Mode Logic Diagram

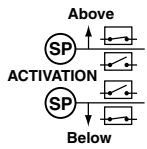

Relay Energize Functions

All setpoints activate at the setpoint value. All relays/setpoints are programmable to energize above or below the setpoint value.

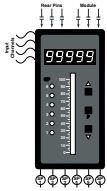

Setpoint Activation Source

Setpoints activate from any input channel, selected meter register, or external switched inputs (digital input pins).

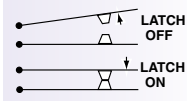

Setpoint Latching

Setpoints can be programmed in relay latching modes.

- SP TRIGGER OPERATES ON:**
 - MAKE EDGE
 - BREAK EDGE
 - MAKE & BREAK EDGE
 - EVERY SAMPLE PERIOD

Setpoint Reset & Trigger

Setpoints can be programmed to reset selected registers, or be manually reset. They can also trigger a data print or a data log.

SP RESET SELECTED REGISTER

SP TRIGGER PRINT

SP TRIGGER LOG DATA



Setpoint Tracking

Setpoint tracking can be applied to setpoints configured in the hysteresis, deviation, or PID modes.



Display Flashing

Display flashing can be applied to setpoints configured in the hysteresis or deviation modes.

Each setpoint can be programmed to make the display flash on and off while the setpoint is active, and keep it flashing until the setpoint de-activates.

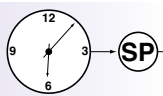

Real-time Clock Option

Any setpoint can be programmed to operate from the real-time clock option.

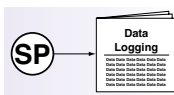

Data Logging

Any setpoint can be programmed to log data within the meter (up to 4000 samples).

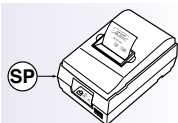

Data Printing to Serial Printer

Any setpoint can be programmed to send data directly to a serial printer.

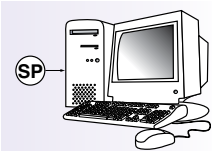

Data Printing to PC

Any setpoint can be programmed to send data directly to a connected PC.

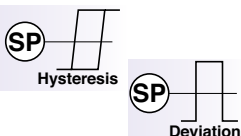

Hysteresis or Deviation

Each relay can operate in a hysteresis or deviation mode.

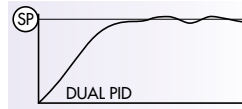

PID Control Settings

The PID (proportional, integral, derivative) control function provides exceptional control stability during control process applica-

tions. PID control is available from the following outputs:

- Setpoint / relay output.
- Analog output.
- Relay and analog output at the same time.

PID control from the setpoint / relay output is available from SP1 and SP2 only.

There are two PID control outputs available via the analog output:

- PID1 – stored in register 50.
- PID2 – stored in register 51.

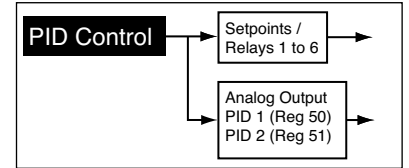

Timer Modes

Each setpoint can be programmed to operate the relay in one of the following seven resident timer modes:

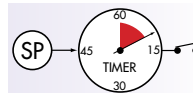

Normal Mode Timer

Single actuation, delay-on-make (DOM) and delay-on-break (DOB).

Normally OFF/Pulsed ON Timers

Repeat ON Mode Timer – multiple actuation, programmable off- and on-time.

Pulse ON Mode Timer – single actuation, programmable DOM and maximum on-time.

1-Shot ON Mode Timer – single actuation, programmable DOM and minimum on-time.

Normally ON/Pulsed OFF Timers

Repeat OFF Mode Timer – multiple actuation, programmable off- and on-time.

Pulse OFF Mode Timer – single actuation, programmable DOB and maximum off-time.

1-Shot OFF Mode Timer – single actuation, programmable DOB and minimum off-time.

Hysteresis or Deviation

Each setpoint can be individually programmed to energize the relay in the hysteresis or deviation mode, with or without initial startup inhibit.

Hysteresis (deadband) is the programmable band above and below the setpoint value that determines when and for how long the relay is energized or de-energized. The setpoint can be programmed to energize the relay above or below the setpoint value.

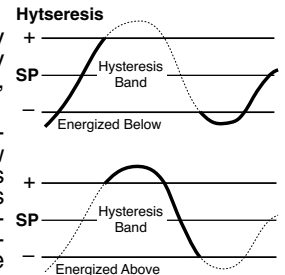

The hysteresis setting can be any value between 0 and 65535 counts. The number of counts selected act both positively and negatively on the setpoint, forming a hysteresis band around the setpoint.

For example, if the setpoint setting is 500 counts and the hysteresis setting is 10 counts, the hysteresis band around the setpoint setting is 20 counts, starting at 490 counts and ending at 510 counts.

Note:

If hysteresis is set with ZERO counts, the relay energizes AT or ABOVE the setpoint value.

Setpoint Programming Mode continued

Deviation (passband) is the programmable band around the setpoint in which the setpoint can be programmed to energize the relay inside or outside the deviation band.

The deviation setting can be any value between 1 and 65535 counts. The number of counts selected act both positively and negatively on the setpoint, forming a deviation band around the setpoint.

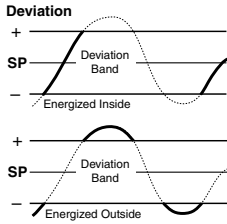

For example, if the setpoint setting is 1000 counts and the deviation setting is 35 counts, the deviation band around the setpoint setting is 70 counts starting at 965 counts and ending at 1035 counts.

Initial Start-up Inhibit.

On power-on, start-up inhibit prevents the relay from energizing on the first setpoint activation cycle. Depending on how the meter has been programmed, initial start-up inhibit either functions during a falling input signal, or during a rising input signal.

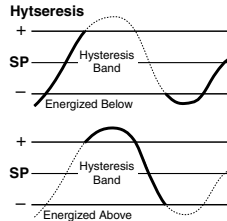

Relay Time Control Modes

The following time control mode settings can cover almost every relay timer application.

All setpoints can be individually programmed to operate a relay in one of the following time control modes above or below the setpoint value.

Normal Mode

This mode individually programs a relay's setpoint with delay-on-make (DOM) and delay-on-break (DOB) settings.

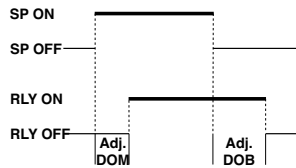

Normally OFF / Pulsed ON Modes

These are delay modes where the relay is **normally off** and **pulses on** when the setpoint activates.

Repeat ON Mode

Multiple actuation, programmable **on** and **off** time settings.

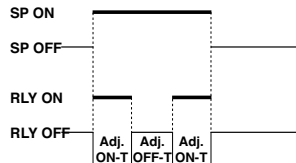

Pulse ON mode (Programmable ON-time)

Single actuation, programmable **DOM** and **on time** settings.

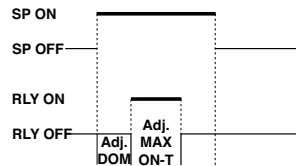

1-Shot ON mode (Programmable Minimum ON-time)

Single actuation, programmable **DOM** and **minimum on time** settings.

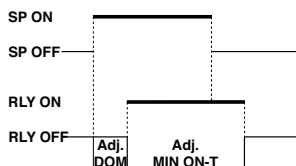

Normally ON / Pulsed OFF Modes

These are delay modes where the relay is **normally on** and **pulses off** when the setpoint activates.

1-Shot OFF mode (Programmable Minimum OFF-time)

Single actuation, programmable **minimum off time** and **DOB** settings.

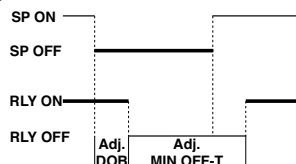

Pulse OFF mode (Programmable OFF-time)

Single actuation, programmable **off time** and **DOB**.

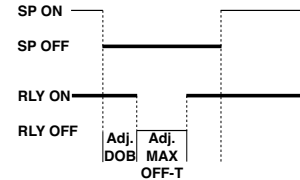

Repeat OFF Mode

Multiple actuation, programmable **off** and **on time** settings.

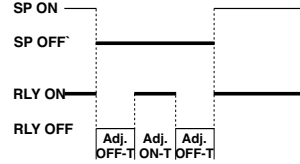

Each setpoint can be individually configured for basic to advanced operations in the following three levels. Each operational level is designed to provide only the required relevant setpoint and relay functions.

The modes at Level 2 and Level 3 can be set to OFF for each individual setpoint, ensuring that no other functions are programmed to influence the setup.

Level 1 Setpoint & Relay Basic Mode

This is an easily programmable mode for users who require the following basic setpoint and relay functions:

First Digit – Relay Energize Functions

Relays programmed to energize above or below the setpoint value.

Second Digit – SP Activation Source

Setpoints programmed to activate from selectable meter registers or one of six external switched inputs.

Third Digit – Setpoint Latching

Relays programmed with latching and manual reset options.

Level 2 Setpoint & Relay Intermediate Mode

Level 2 uses all Level 1 functions and is further extended by the following programmable modes. The functionality of the relay energize functions are extended by allowing the relays to be programmed with or without initial start-up inhibit.

Hysteresis, Deviation & PID Mode

This mode adds extra functionality to the basic mode by providing programmable hysteresis or deviation settings for all setpoints, or PID control from setpoints SP1 and SP2.

Timer Modes

These modes add even more functionality to the basic and intermediate mode by providing each setpoint with a choice of one of seven resident programmable timers.

Level 3 Setpoint & Relay Advanced Mode

Level 3 uses all Level 1 and Level 2 functions combined with reset and trigger functions to provide an extremely powerful advanced mode.

Level 3 enables you to program all setpoints individually for operations normally requiring sophisticated controllers.

Setpoint Programming Mode – Programming Procedures

Example Procedure:

The following procedure describes how to program setpoint 1 (SP1) for the following **Level 1** setpoint and relay functions:

- SP1 to activate from Channel 1 (CH1).
- Relay to energize above or below SP1 value.
- Relay to latch with manual relay reset.

See *Setpoints and Relays Supplement (NZ201)* for procedures to program all setpoint and relay operational levels (Level 1 to Level 3).

START HERE

CONFIGURE LEVEL 1 SETPOINT & RELAY FUNCTIONS

Step 1
Enter Brightness Mode



Step 2
Adjust setpoint 1 (SP1) activation value to e.g. 500 counts

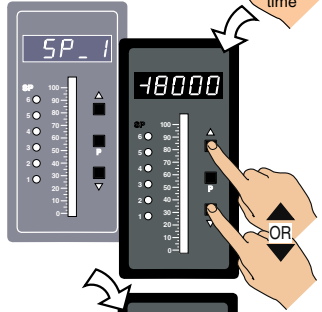

Step 3
Save SP1 activation value setting

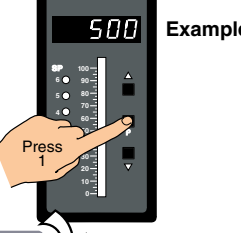

Step 4
Set SPC_1 to [013]:
1st Digit = 0 Energize above SP1 value or 1 to energize below SP1 value
2nd Digit = 1 Select source for SP1
3rd Digit = 3 Relay latching with manual reset

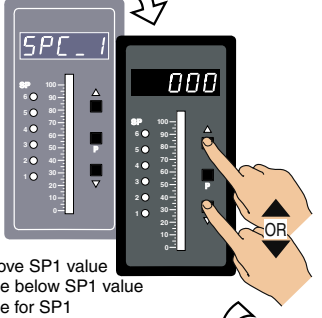

Step 5
Enter SP1 source sub-menu

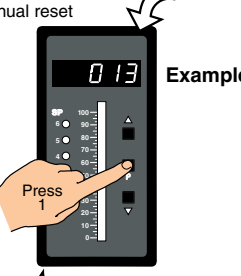

To Step 6

From Step 5

Step 6
Select [CH1] as the SP1 activation source. See diagram on Pages 38 and 39

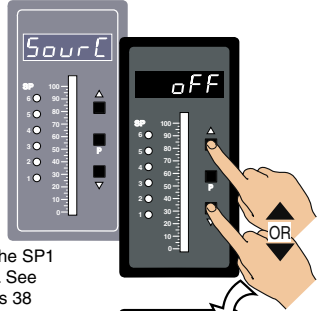

Step 7
Save SP1 control settings

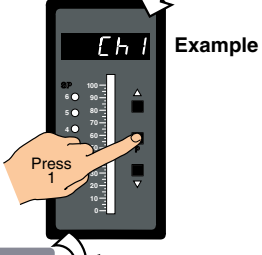

Step 8
Reset 2nd digit to 0. If the 2nd digit is not reset to 0, the meter will constantly cycle thru SPC_1

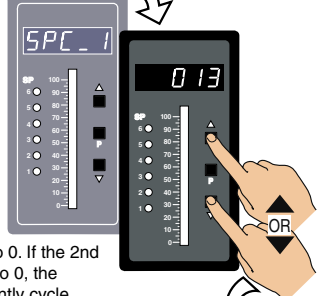

Step 9
Save SP1 control settings

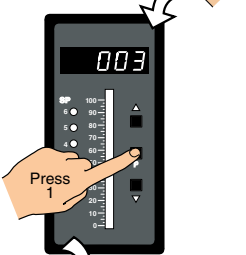

Step 10
Exit SPC_2. Return to Operational Display

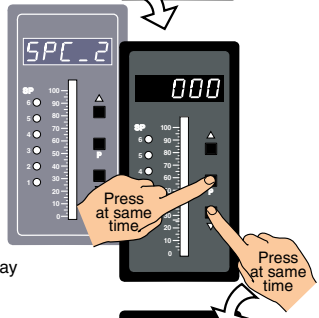

Operational Display



Programming tip

All required setpoint activation values (SP1 to SP6) can be adjusted before programming setpoint and relay control function settings. See *Setpoint Programming Mode Logic Diagram* on Page 38.

Setpoint & Relay Control Settings Diagram

The diagram below and continued on Page 39 shows the 1st, 2nd, and 3rd digit control settings for the setpoints and relays.

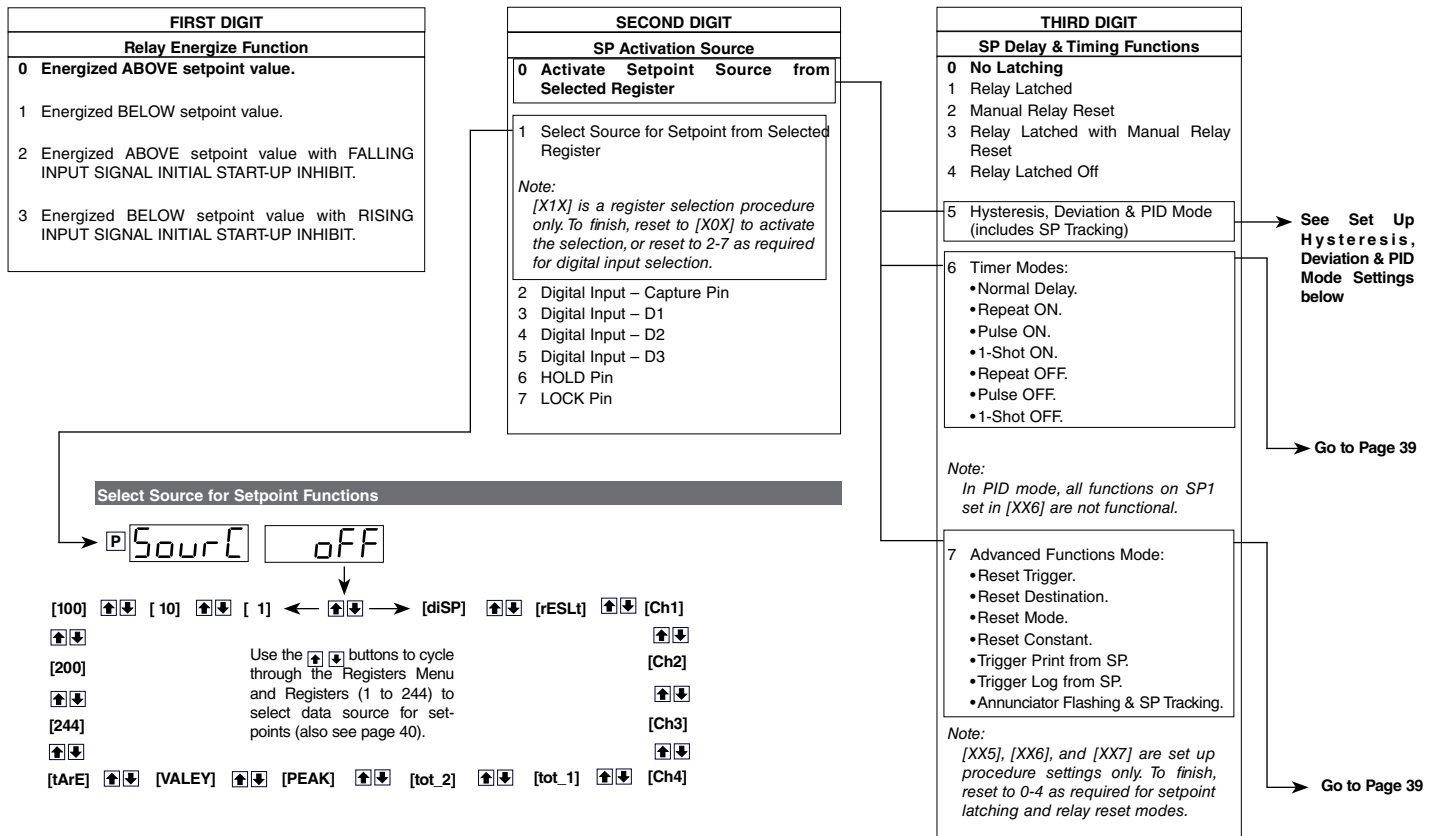

Set Up Hysteresis, Deviation & PID Mode Settings



Programming Tip

If you do not require any of the functions in this mode, ensure it is set to:

Mode off

Third digit set to [XX5]

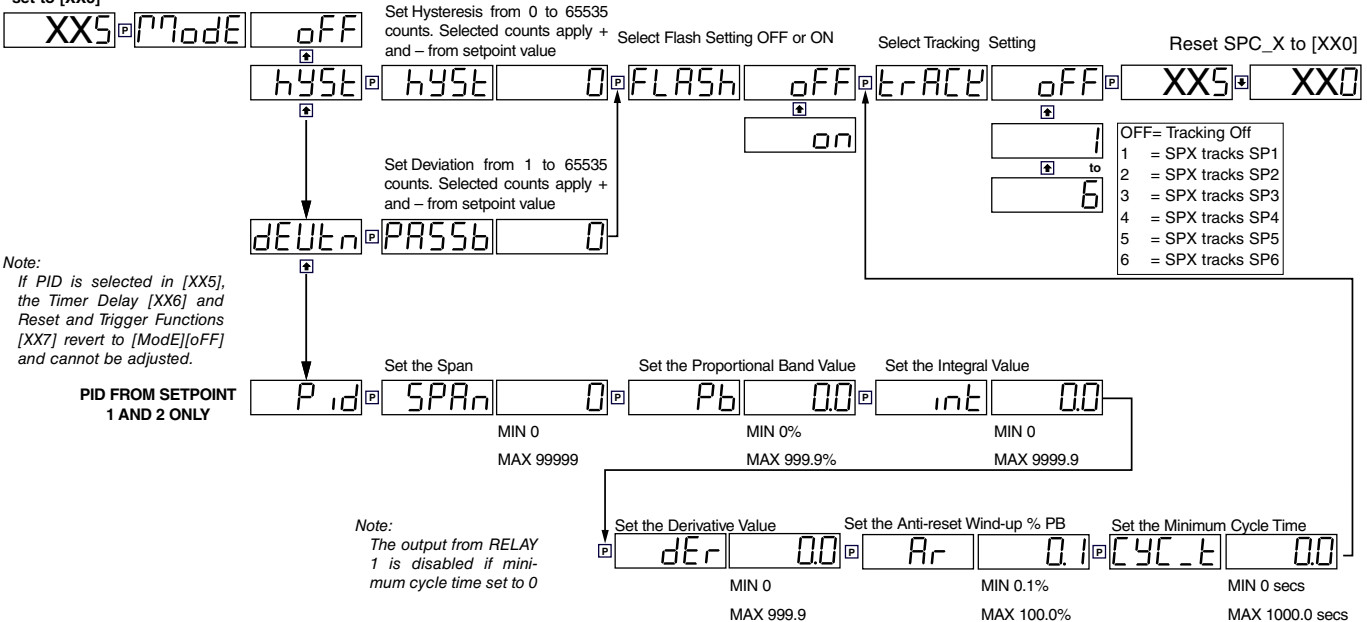

Setpoint Programming Mode continued

Set Up Timer Delay Settings



Programming Tip

If you do not require any of the functions in this mode, ensure it is set to:

timer off

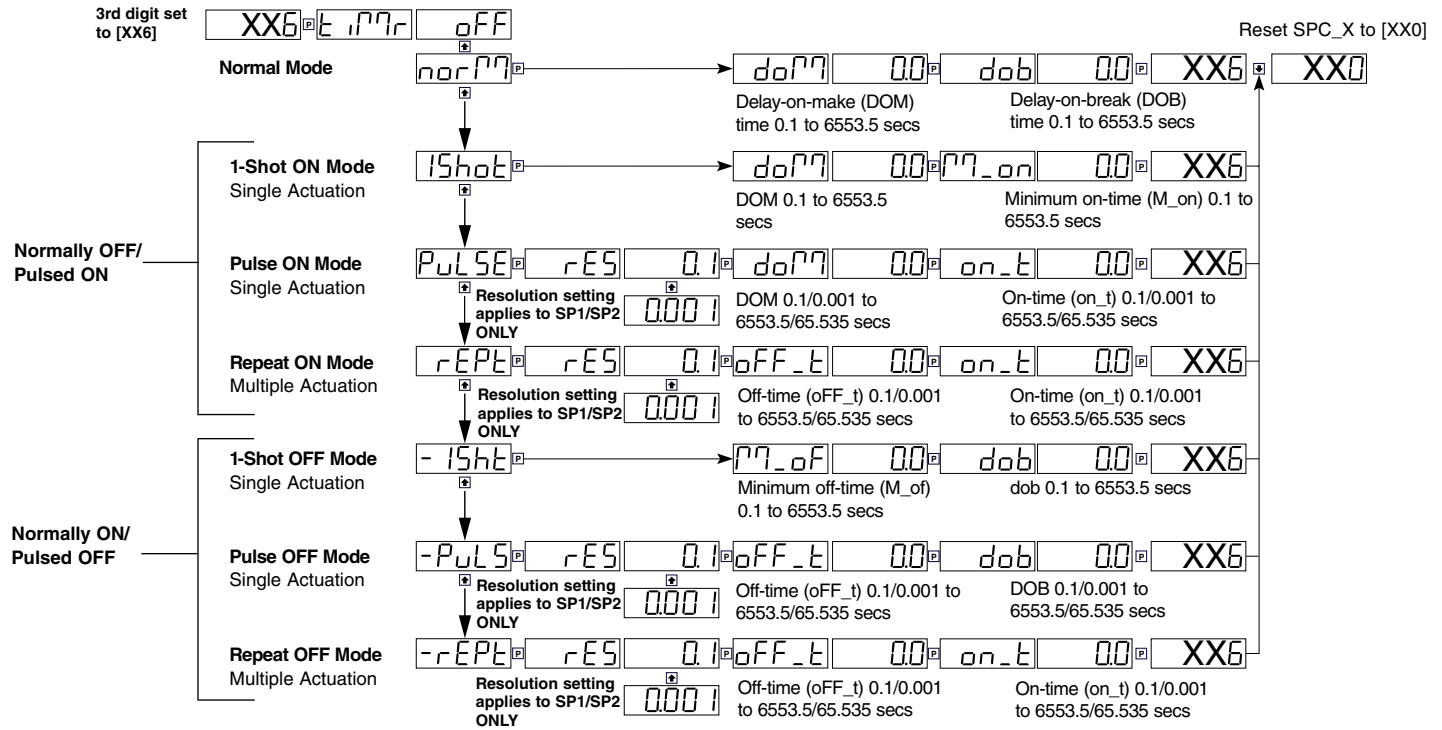

Set Up Register Reset and Setpoint Trigger Functions

Third digit set to [XX7]

Select Trigger Setting

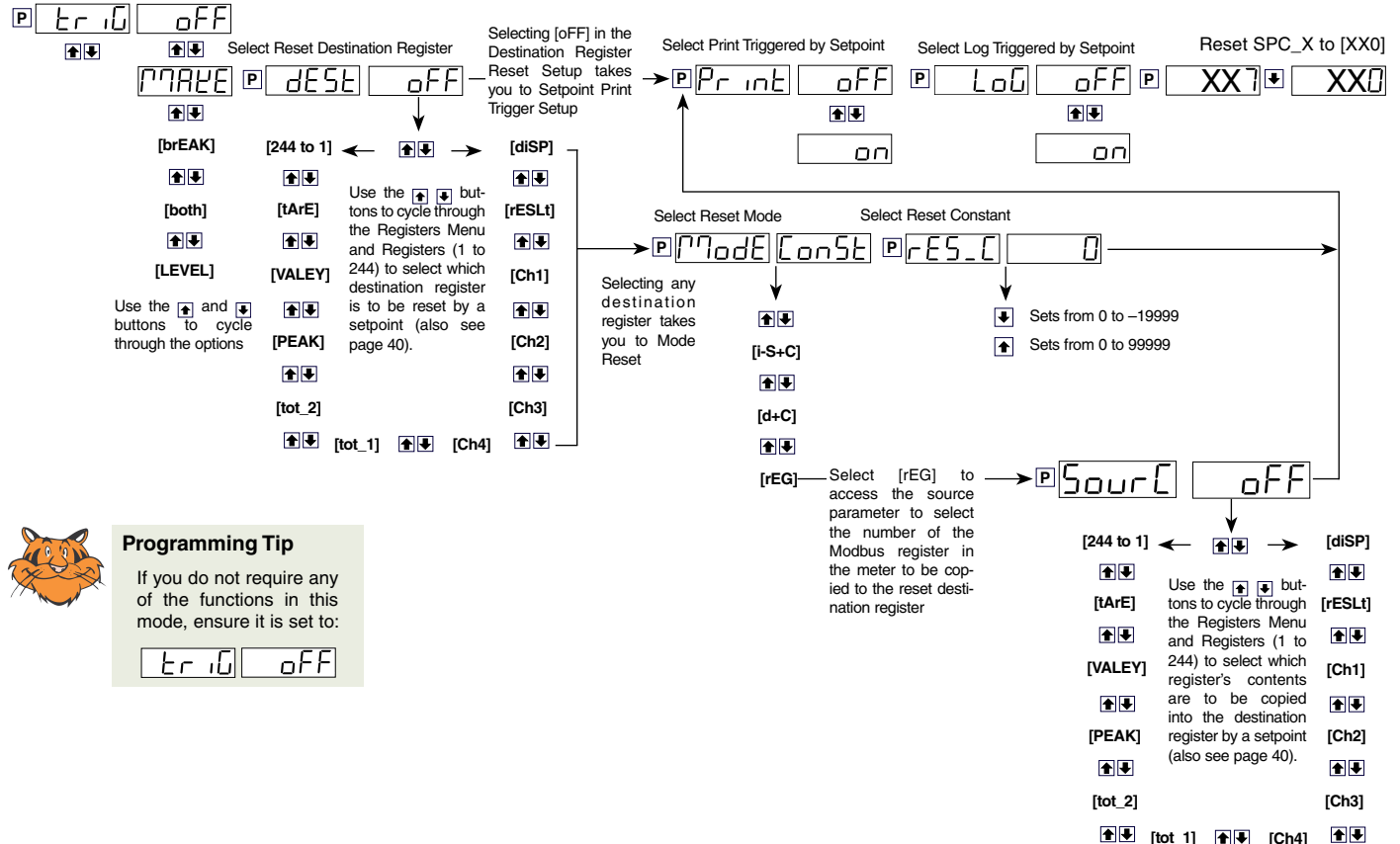

Programming Tip

If you do not require any of the functions in this mode, ensure it is set to:

timer off

Registers That Can Be Selected By Front Panel Push Button Programming

A Tiger 320 Series meter has 6,144 registers which are provided for use by the operating system and the powerful Custom Macro Programming system.

40 Manually Selectable Registers

Using the front panel buttons, there are 40 registers that may be selected for use within the following functions:

- **[CodE_1] - Display Configuration [X50]**. Selection of a register as the data source for displays, peak and valley, totalizers and analog outputs. (See pages 20 & 21)
- **Setpoint Control Settings [X1X]**. Selection of a register as the data source for a setpoint. (See Page 38)
- **Setpoint Control Settings [XX7]**. Selection of a destination register that is to be reset by a setpoint with the contents of a selected source register. (See Page 39)
- **Setpoint Control Settings [XX7]**. Select which register's contents are to be copied into the destination register by a setpoint. (See Page 39)

The 40 registers that can be selected as a data source, a reset source or a reset destination for the functions above are shown in the table on the right.

The table shows, in seven columns, the functions where these registers can be used.

Where a register is more likely to be used in a particular function, a closed circle ● is shown in the column. For those functions where a register is less likely to be used, an open circle ° is shown.

No register number is shown for the first 11 functions, because these 11 functions are identified in the display menu for direct selection by their code names.

When cycling through the Registers Menu and then Registers 1 to 244, the numerical Register Set will increment through each decade in turn, from 1 to 0, while the button is held down. When [200] is reached, [oFF] or [tArE] will be displayed. To select a specific number set, the button should be released and pressed again each time the left most decade displays the desired number for that decade.

To quickly exit the numerical 1 to 244 Register Set, hold the [P] button down while cycling through the decades, and release it when [oFF] or [tArE] appears.

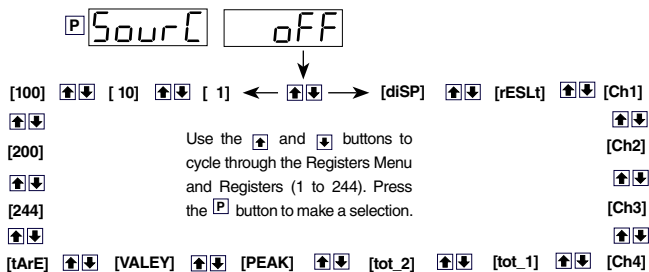

Registers that Should Not be Used

The following registers are contained within the selectable 1 to 244 Register Set, but they should not be selected because they are either reserved for future use, or for use by the operating system only:

15, 38, 47-48, 52-53, 61-64, 123-128, 140-141, 234-244

Any selection of these Registers may cause a malfunction.

Register Functions	Register Numbers	Data Source for Displays	Data Source for Peak & Valley	Data Source for Analog Outputs 1 & 2	Data Source for Totalizers 1 & 2	Data Source for Setpoints	Reset Source	Reset Dest.
Display [diSP]	-		●	●	●	●		
Result [rESLt]	-	●	●	●	●	●	●	●
CH1 [Ch1]	-	●	●	●	●	●	●	●
CH2 [Ch2]	-	●	●	●	●	●	●	●
CH3 [Ch3]	-	●	●	●	●	●	●	●
CH4 [Ch4]	-	●	●	●	●	●	●	●
Total 1 [tot_1]	-	●	●	●		●	●	●
Total 2 [tot_2]	-	●	●	●		●	●	●
Peak [PEAK]	-	°				●	°	●
Valley [VALEY]	-	°				●	°	●
Tare [tArE]	-	°	°	°			°	●
PID Output 1	50	°	°	°		°		
PID Output 2	51	°	°	°		°		
Smart Result 1	54	°	°	°				°
Smart Result 2	55	°	°	°				°
Smart Result 3	56	°	°	°				°
Smart Result 4	57	°	°	°				°
Smart Result 5	58							°
Smart Result 6	59							°
Smart Result 7	60							°
Analog Output 1	83	°				°	°	°
Analog Output 2	84	°				°	°	°
Timer 1	95	°				°	°	°
Timer 2	96	°				°	°	°
Smart Reset Offset 1	121							●
Smart Reset Offset 2	122							●
Clock - Seconds	213					°		
Clock - Minutes	214					°		
Clock - Hours	215					°		
Clock - Days	216					°		
Clock - Date	217					°		
Clock - Month	218					°		
Clock - Year	219					°		
Setpoint Latch	221							●
Relay De-energize	222							●
Zero Offset - Result	227					°		
Zero Offset - CH1	228					°		
Zero Offset - CH2	229					°		
Zero Offset - CH3	230					°		
Zero Offset - CH4	231					°		

Resetting and Incrementing Using Setpoints

Setpoints may be used to reset and/or increment registers. In the example shown below, 2 liter soft drink bottles are being filled and packed 12 to a case. Using the setpoint reset and increment feature, the number of bottles and the total number of filled cases is easily calculated and displayed. Totalizer 1 counts from 0 to 2, resets, and repeats. CH 2 counts from 0 to 12, resets, and repeats.

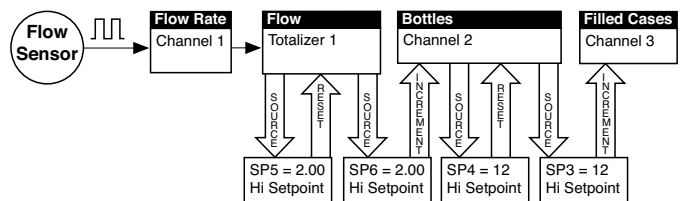

USING SETPOINTS TO INCREMENT AND RESET REGISTERS

Functional Diagram

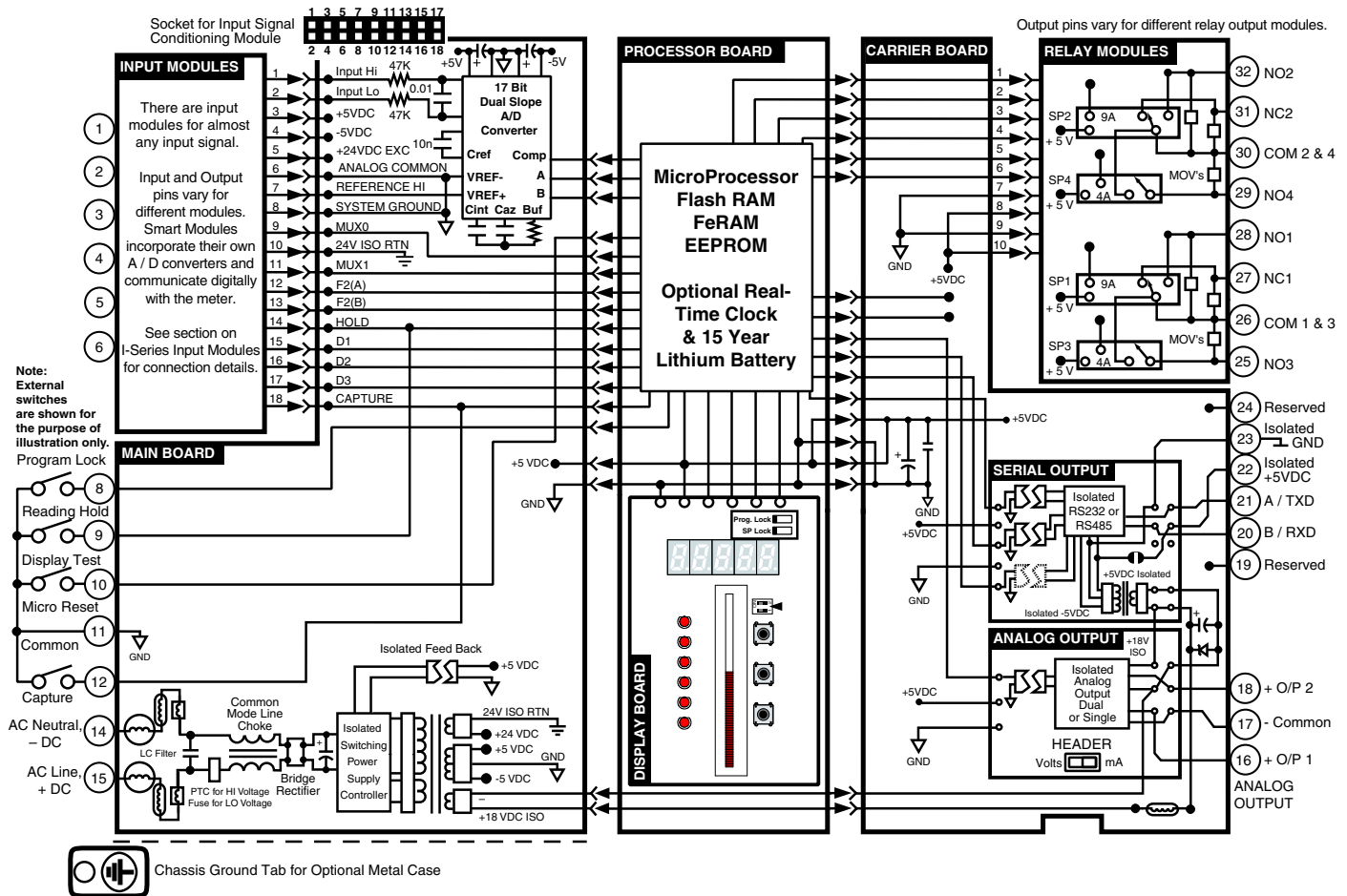

Connector Pinouts

Rear Panel Pinout Diagram

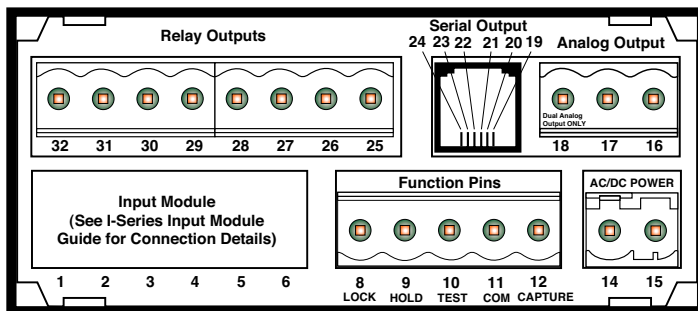

WARNING: AC and DC input signals and power supply voltages can be hazardous. Do Not connect live wires to screw terminal plugs, and do not insert, remove or handle screw terminal plugs with live wires connected.

Input Signal – Pins 1 to 6

See the *I-Series Input Modules Guide (Z87)* for connection details of all input modules. On most single input signal conditioners, usually Pin 1 is the signal high pin (Hi +) and Pin 3 is the signal low pin (Lo -).

Function Pins – Pins 8 to 15

Pin 8 – Program Lock. By connecting the PROGRAM LOCK pin to the COMMON pin (pin 11 on the main PCB), the PROGRAM LOCK pin allows the meter's programmed parameters to be viewed but not changed.

Pin 9 – Hold Reading. By connecting the HOLD READING pin to the COMMON pin (pin 11), the HOLD READING pin allows the

NOTE: The meter uses plug-in type screw terminal connectors for most input and output connections and an RJ-6 phone connector for the optional RS-232 or RS-485 serial outputs.

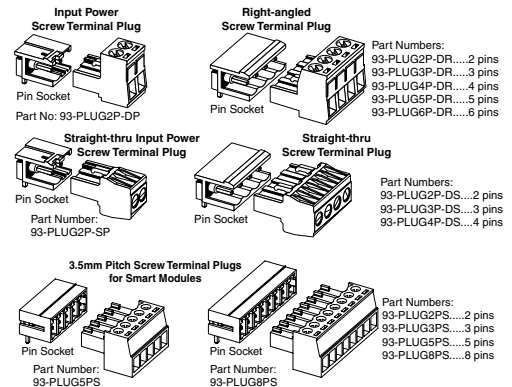

meter's display to be frozen. However, A/D conversions continue and as soon as pin 9 is disconnected from pin 11 the updated reading is instantly displayed.

Pin 10 – Display Test and Reset. The DISPLAY TEST and RESET pin provides a test of the meter's display and resets the microprocessor when the DISPLAY TEST and RESET pin is connected to the COMMON pin (pin 11).

Pin 11 – Common. To activate the HOLD, TEST and RESET, or LOCKOUT pins from the rear of the meter, the respective pins have to be connected to the COMMON pin.

Pins 14/15 – AC/DC Power Input. These are the pins that supply power to the meter. See Power Supply for details of the standard and optional low voltage power supply.

Chassis Ground Tab. Only on versions with metal sheath casing.

Carrier Board Output Pins

Analog Outputs

- Pin 16 – Positive (+) analog output 1.
- Pin 17 – Negative (-) analog output 1 and 2.
- Pin 18 – Positive (+) analog output 2.

Serial Outputs RS-232 or RS-485

Pin No.	RS-232	RS-485
19	Reserved for future use	Reserved for future use
20	RXD. Received Serial	B (Low)
21	TXD. Transmitted Serial	A (High)
22	+5 VDC to power external converters	+5 VDC to power external converters
23	Isolated Ground	Isolated Ground
24	Reserved for future use	Reserved for future use



Ethernet – The Ethernet carrier board has the same analog output pins, with 10/100Base-T Ethernet (RJ-45 Socket).

Relay and Logic I/O Modules

Opto Isolated I/O Module for External Breakout Box with 6 Outputs & 6 Inputs, or 16 Outputs & 6 Inputs

Order Code	NPN Open Collector Max 50V @ 100mA Setpoint	Sink/Source MACRO Setpoint	Logic Input
OR81	6 Outputs	-	6 Inputs
OR82	6 Outputs	10 MACRO Outputs	6 Inputs

Relay Modules with up to two 4/5A Form A Relays, and up to two 9/10A Form C Relays

Order Code	Options
	SP2 SP4 SP1 SP3
OR11	- - 10A -
OR12	9A - 9A -
OR23	9A 4A 9A -
OR14	9A 4A 9A 4A
OR15	- 4A 9A 4A
OR16	- 4A 9A -

Relay Modules with up to 4 Independent 300V (210mA DC only) SSRs

Order Code	Options			
	SP4	SP3	SP2	SP1
OR51	-	-	-	210mA
OR52	-	-	210mA	210mA
OR53	-	210mA	210mA	210mA
OR54	210mA	210mA	210mA	210mA

Relay Modules with five or six 4A Form A Relays

Order Code	Options					
	SP6	SP5	SP4	SP3	SP2	SP1
OR45	-	4A	4A	4A	4A	4A
OR46	4A	4A	4A	4A	4A	4A

Open Collector / TTL / 5VDC Output (50 mA)

Order Code	Options					
	SP6	SP5	SP4	SP3	SP2	SP1
OR71	0 to 5V	0 to 5V	0 to 5V	0 to 5V	0 to 5V	0 to 5V
OR72	0 to V+	0 to V+	0 to V+	0 to V+	0 to V+	0 to V+

Relay Modules with up to four 5A Form A Relays

Order Code	Options			
	SP4	SP3	SP2	SP1
OR31	-	-	-	5A
OR32	-	-	5A	5A
OR33	-	5A	5A	5A
OR34	5A	5A	5A	5A

Flash Card Memory Module

Order Code	Options
OR91	MODULE WITH 4 MEG MEMORY

Modular Construction

The Tiger 320 Series of 32-bit Programmable Meter Controllers incorporates, in one instrument, all the different functions required by today's automation and process control applications. This is made possible by modular construction, around standard case sizes, built to American, European, and Japanese standards.

The range comes with a wide variety of display options, including 5 or 6-digit numeric or alphanumeric displays, 6-digit LCD displays, and 51 or 101-segment red, green, or tri-color straight and circular bargraphs.

All meters are housed in one of three DIN case sizes, or the popular 4" ANSI case, and provide the ideal solution for your measurement and process control applications.

Modular construction ensures you don't have to pay for unnecessary hardware. Simply order the input and output options to suit your application.

320 Series Base Meter

- Power Supply – standard or optional low voltage.
- Processor.
- Display – red, green, or super bright red LEDs

Input Signal Conditioning Modules

Select from over 120 single, dual, triple, or quad inputs covering almost every input signal type.

Standard Serial Output Carrier Board or Optional Ethernet Carrier Board

Relay Modules

Electromechanical Relays

- Max 6 Form A
- Max 2 Form A, 2 Form C
- Max 4 Form A

Solid State Relays

- DC only
- AC / DC

Opto Isolated I/O Module

- 6 Outputs, 6 Inputs
- 16 Outputs, 6 Inputs

Open Collector / TTL / 5V Output

- 0 to 5V
- 0 to V+

Flash Card Memory Module

- Module with 8 Meg Memory
- Module with 16 Meg Memory

Serial Output Modules

- RS-232 Module*
- RS-485 Module*

Mount on a standard carrier board.

*RS-232 and RS-485 modules cannot be used with the optional Ethernet Carrier Board.

Analog Output Modules

- 0-20 mA
- 0-10 VDC
- Dual 0-10 VDC

Tiger 320 Series Modular Construction

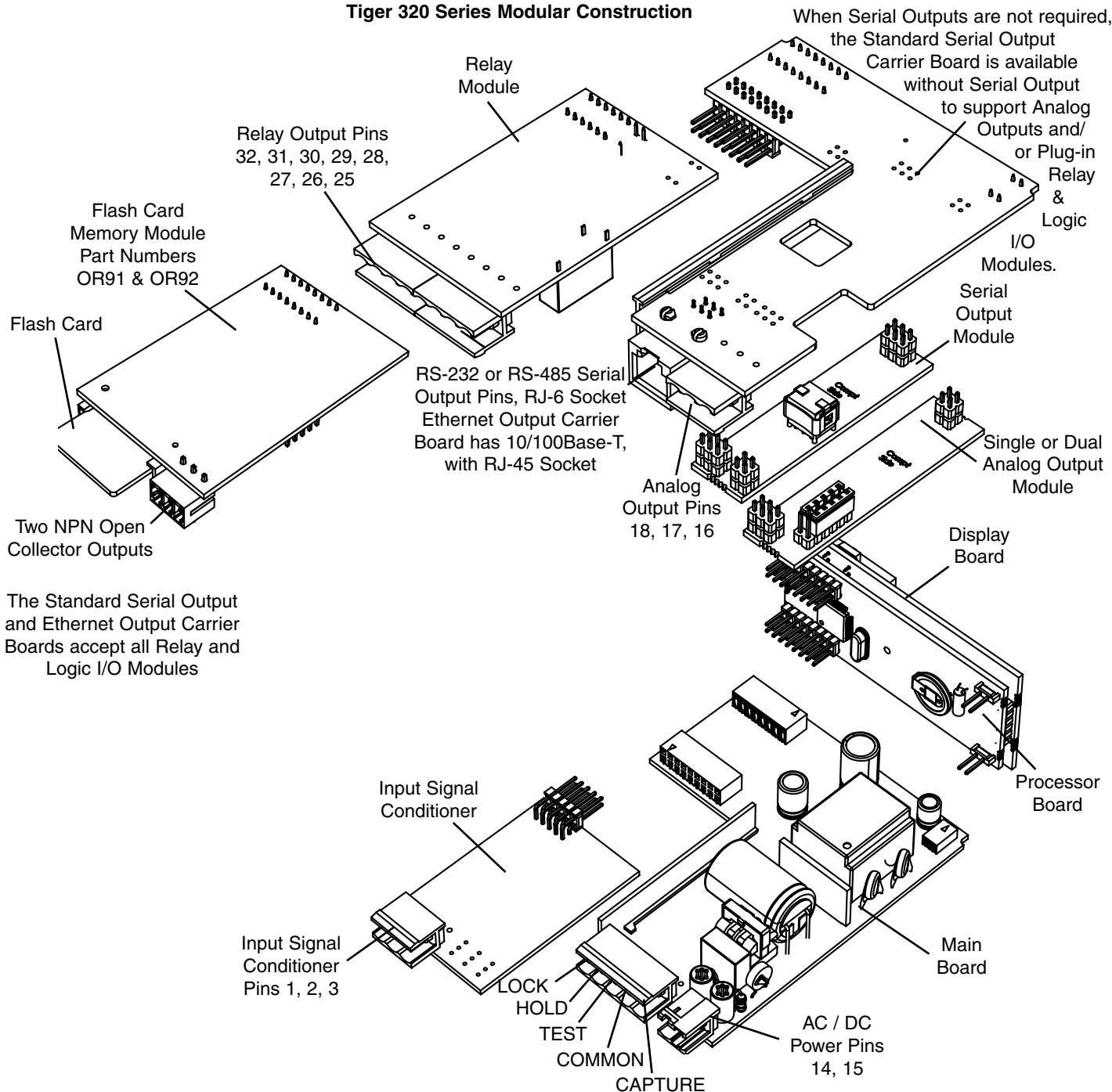

The Standard Serial Output and Ethernet Output Carrier Boards accept all Relay and Logic I/O Modules

Input Signal Conditioner

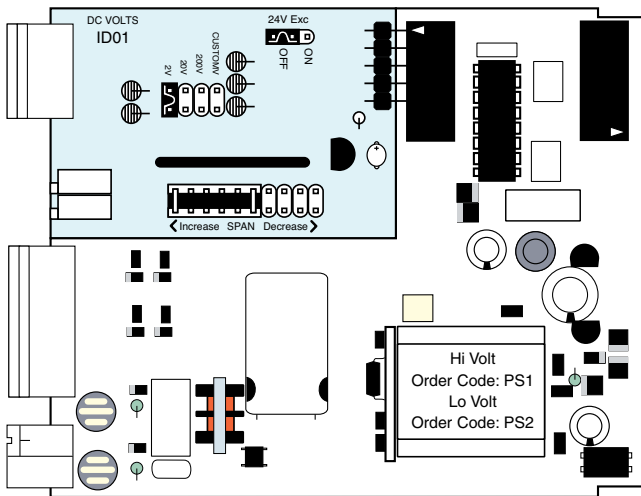

Main PCB*

*Shown with optional Input Signal Conditioning Module (Ordered Separately)

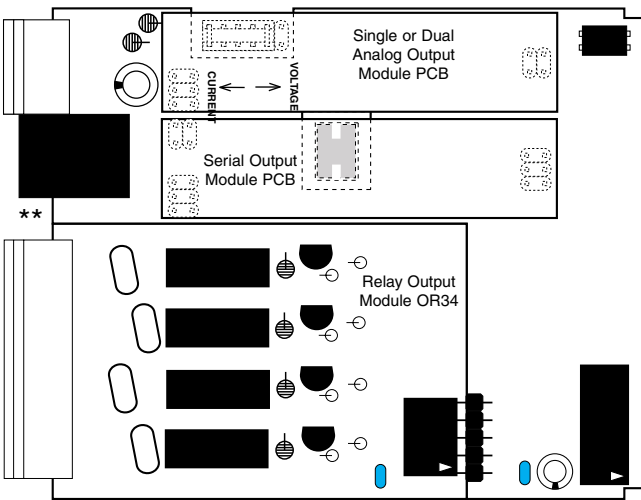

Standard Output Carrier Board*

*Shown with optional Analog Output Module, optional Relay Output Module and a Serial Output Module (RS-232, RS-485 or No Serial Output)

Ethernet Output Carrier Board**

**Is similar to the Standard Output Module Carrier Board, except that the RJ-6 socket is replaced with a 10/100Base-T RJ-45 Socket

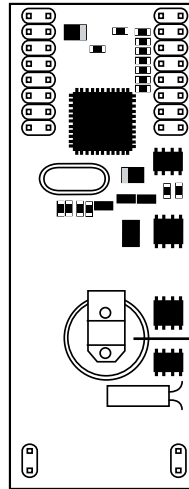

Processor Board

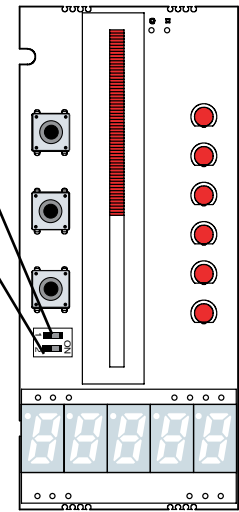

Display Board

Analog Output Module PCB

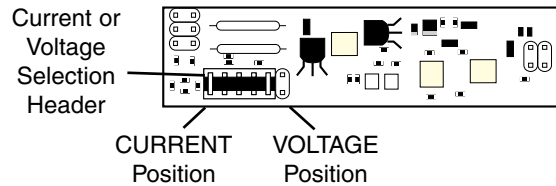

Available in Single (0-4-20mA or 0-10V) or Dual (0-10V & 0-10V)

Standard Serial Output Modules RS-232 or RS-485

Note:
Externally mounted Ethernet compatible communication output modules are available that connect directly to the standard (RS-232 / RS-485) serial module outputs.

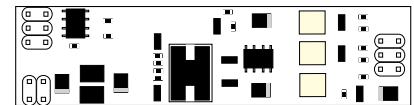

RS-485 Output Module PCB

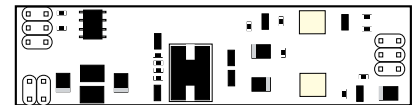

RS-232 Output Module PCB

Opto Isolated I/O Modules Connect to External DIN Rail Mounting Breakout Box

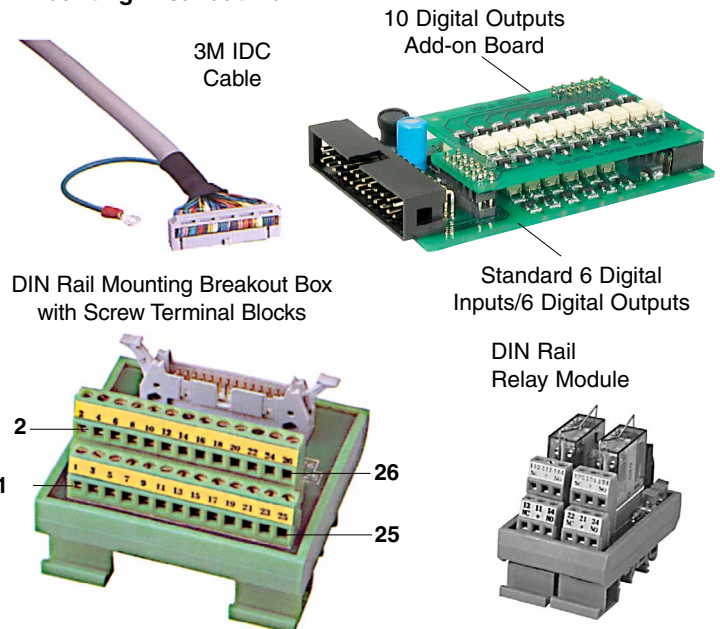

Installation

1. Install and wire meter per local applicable codes/regulations, the particular application, and good installation practices.
2. Install meter in a location that does not exceed the maximum operating temperature and that provides good air circulation.
3. Separate input/output leads from power lines to protect the meter from external noise. Input/output leads should be routed as far away as possible from contactors, control relays, transformers and other noisy components. Shielding cables for input/output leads is recommended with shield connection to earth ground near the meter preferred.
4. A circuit breaker or disconnect switch is required to disconnect power to the meter. The breaker/switch should be in close proximity to the meter and marked as the disconnecting device for the meter or meter circuit. The circuit breaker or wall switch must be rated for the applied voltage (e.g., 120VAC or 240VAC) and current appropriate for the electrical application (e.g., 15A or 20A).
5. See *Case Dimensions* section for panel cutout information.
6. See *Connector Pinouts* section for wiring.
7. Use 28-12 AWG wiring, minimum 90°C (HH) temperature rating. Strip wire approximately 0.3 in. (7-8 mm).
8. Recommended torque on all terminal plug screws is 4.5 lb-in (0.51 N-m).



Analog Output / Analog Retransmission	13-14	Clock/Timer	
Calibration of Analog Output.....	13	Configuration.....	27, 30, 31
Dual (0-10V) Analog Output.....	13	Real-time Clock Configuration.....	27, 30, 31
Location of Analog Output Module.....	43	Real-time Clock Date.....	33
Pinout of Analog Output.....	42	Time Stamp.....	33
Scaling of Analog Output.....	13-14	Component Layout & External Devices	
Select Source for Analog Output.....	13	Modular Construction.....	43
Auto Zero Maintenance for Weighing Applications	14	Component Layout.....	44
Set Parameters for CH1, CH2, CH3 & CH4.....	13	Connections	
Averaging - Digital Filtering	14	Carrier Board Output Pinouts.....	42
Set Parameters for CH1, CH2, CH3 & CH4.....	13	Connector Pinouts.....	41
Block Diagram of Software & Hardware	4	External Devices.....	44
Brightness Display	12	Rear Panel Pinout Diagram.....	41
Calibration	13-16	Controls & Indicators	6-7
Calibration Thermocouple or RTD.....	13	Annunciator LEDs.....	6
Manual Calibration.....	15	Down Button.....	6
Single-Point Calibration.....	15	Error Message.....	7
Two-Point Calibration.....	15	LED Display.....	6
Case Dimensions	48	Program Button.....	6
Modular Construction.....	43	Program Lockout Switch.....	7
Channel 1 Settings	27-28	Scrolling Display Text Messaging.....	6
32 Point Linearization.....	28	Setpoint Lockout Switch.....	7
Analog Input Signal Sample Rate.....	27	Seven Segment LED Displays.....	6
Counter/Resident Timer/Clock.....	27	Up Button.....	6
Measurement Task.....	27	Data Logging	
Post Processing.....	28	Downloading Logged Data from Meter.....	33
Print Mode.....	28	Printing Logged Data.....	33
Sampling Rate.....	27	Real-time Clock.....	33
Serial Mode.....	28	Digital Input Pins	33
Smart Input Module.....	27	Display Brightness Setting	12
Channel 2 Settings	29	Display Functions	17-26
Channel 3 Settings	30	Data Source.....	21
Channel 4 Settings	31	Display Format and Decimals.....	22
Channel 1 & Channel 2 Results Processing		Display Rounding.....	22
32 Point Linearization.....	32	Last Digit Text Character.....	23
Maths Functions.....	32	Setpoint Annunciator Mode.....	24
Code 1 - Display Configuration	17-26	Update at Sample Rate.....	24
Configure Data Source Procedure.....	21	Filtering	
Configure Display Format Mode Procedure.....	22	<i>See Averaging Samples & Averaging Window</i>	
Configure Last Digit Text Char. Procedure.....	23	Front Panel Controls	6-7
Configure Setpoint Annunciators Procedure.....	24	Front Panel Programming Codes	9-10
Configure Update at Sample Rate Procedure.....	24	Main Programming Mode.....	9
Data Source - 2nd Digit [X5X].....	17	On Demand Modes.....	10
Display Format - 2nd Digit [X6X].....	17	Setpoint Programming Mode.....	9
Display Functions Mode.....	17	View Modes.....	10
Manual Loader Mode.....	17	Functional Diagram	41
Setpoint Annunciators Mode.....	17	General Features	1
Text Character - 2nd Digit [X7X].....	17	Hysteresis and Deviation	35-36, 38
Update Display at Selected Sample Rate.....	17	Initial Setup Procedures	11-12
Code 2 - Channel 1 Measurement Task		Code Blanking and Macro Check.....	11-12
and Sampling Rate	27	Model and Software Code Version Check.....	11
Code 3 - Channel 1 Post Processing		Input Signal Conditioning Modules	
and Serial Mode Functions	28	Modular Position.....	43
Code 4 - Channel 2 Measurement Task		I/Os (Opto Isolated & Logic Ports)	44
and Sampling Rate	29	Linearization	
Code 5 - Channel 3 Functions	30	Channel 1 Temperature Sensors.....	27
Code 6 - Channel 4 Functions	31	Channel 1 User Loaded Tables.....	28
Code 7 - Result Processing	32	Channel 2 Temperature Sensors	
Code 8 - Data Logging & Print Mode	33	and User Loaded Tables	29
Code 9 - Functions for Digital Input Pins	33	Channel 3 Temperature Sensors	
Code Blanking	11-12	and User Loaded Tables	30

Channel 4 Temperature Sensors and User Loaded Tables	31
Result of CH1 & CH2 User Loaded Tables	32
Table Settings.....	14, 32
Macros	
Macro Check.....	11-12
Manual Loader.....	17
Maths Function	
Cross Channel Maths	4, 32
Result Processing	32
Modbus	14
Model Type Check.....	11
On Demand Functions.....	13
Panel Cutout.....	48
PID Control Settings	35, 38
Power Supply	41
Prescaling	
Channel 1.....	27
Channel 2.....	29
Print Mode.....	29
Programming Codes.....	9-10
Programming Conventions	8
Registers	
Registers That Can Be Selected.....	40
Registers That Should Not Be Selected	40
Resetting and Incrementing Using Setpoints.....	40
Relay & Logic Output Modules.....	42
Serial Communication	
Configuration.....	20
Pinouts	41
Setpoint Programming Mode.....	34-39
Data Logging.....	35
Data Printing to PC	35
Data Printing to Serial Printer	35
Display Flashing.....	35
Hysteresis or Deviation	35-36, 38
Level 1 - Basic Mode - Prog. Procedures	37
PID Control Settings	35, 38
Real-time Clock Option	35
Real Time Control Modes	36
Relay Energize Functions	35
Relay Output Modules.....	34
Setpoint & Relay Control Settings.....	34, 38
Setpoint Activation Source	35
Setpoint Activation Values.....	34
Setpoint Latching	35
Setpoint Reset & Trigger	35, 39
Setpoint Tracking.....	35
Timer Modes	35, 39
Smart Input Modules	
Setting Up	27
Table of Contents.....	1
Timers	35
Configuration.....	27, 30, 31
Delay Settings	39
Modes	36
Totalizers	
Setting.....	13-14

Case Dimensions

PANEL CUTOUT

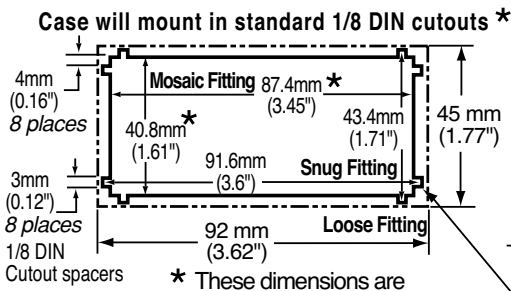

* These dimensions are increased by 1.6mm (0.06") when the **metal surround case** is installed.

SIDE VIEW

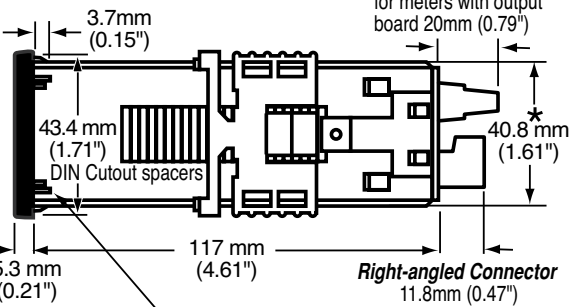

For extra strength in portable applications, the 8 DIN spacers should be snipped off and the **Mosaic fitting** cutout used. Alternatively, the **High Strength Panel Mounting Kit** (Part # OP-PMA96X48) can be used.

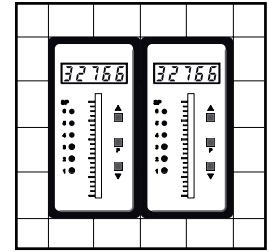

The 96x48mm case is particularly suitable for mounting in mosaic panels or insulative panels up to 2" thick. They can also stack mount, 2 up in existing cutouts for 1/4 DIN (96x96mm) or 4 up in 1/2 DIN (96x192mm).

When extra panel mounting tightness is required, order the optional **screw mount clip**.
P/N:(OP-MTLCLIP)

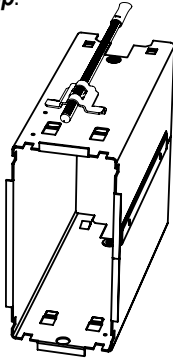
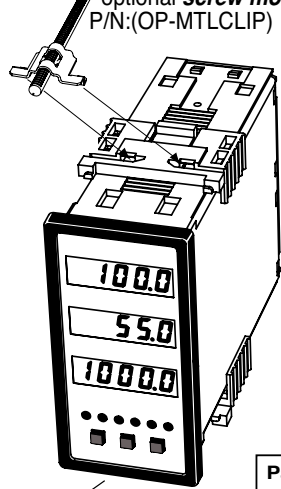

Metal Surround Case
(P/N: OP-MTL96X48)

Metal Surround Case uses **Metal Screw Mount Clips** and has a max. panel thickness mounting of 15.5 mm (0.61").

NOTE: The Metal Surround Case is pre-installed at the factory and cannot be removed without damage to the case.

TOP VIEW

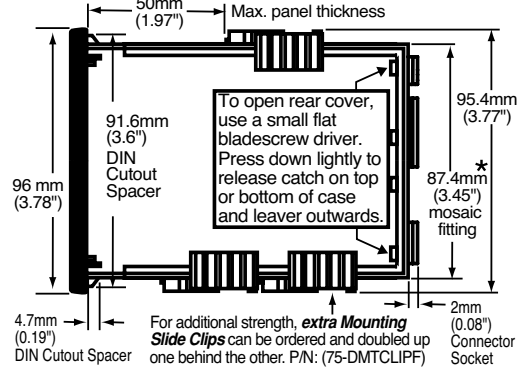

Various bezel colors are available. Black is standard.

Panel adaptor plates are available to retrofit most existing panel cutouts.

96x48 Panel to Case Seal Adaptor Kit
P/N: OP-PMA96X48

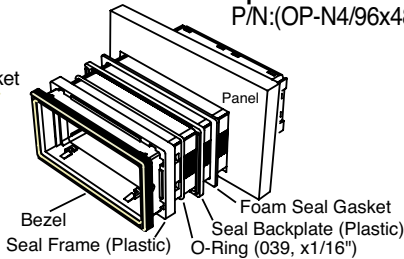
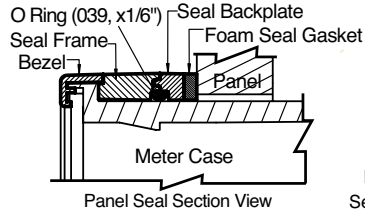

FRONT VIEW

1/8 DIN 48x96mm

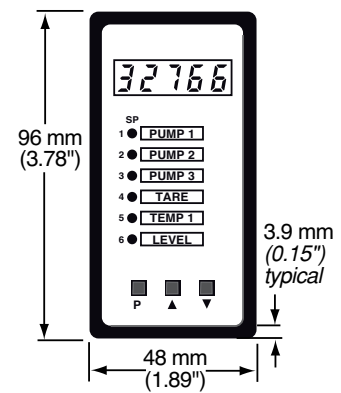

WARRANTY

Texmate warrants that its products are free from defects in material and workmanship under normal use and service for a period of one year from date of shipment. Texmate's obligations under this warranty are limited to replacement or repair, at its option, at its factory, of any of the products which shall, within the applicable period after shipment, be returned to Texmate's facility, transportation charges pre-paid, and which are, after examination, disclosed to the satisfaction of Texmate to be thus defective. The warranty shall not apply to any equipment which shall have been repaired or altered, except by Texmate, or which shall have been subjected to misuse, negligence, or accident. In no case shall Texmate's liability exceed the original purchase price. The aforementioned provisions do not extend the original warranty period of any product which has been either repaired or replaced by Texmate.

USER'S RESPONSIBILITY

We are pleased to offer suggestions on the use of our various products either by way of printed matter or through direct contact with our sales/application engineering staff. However, since we have no control over the use of our products once they are shipped, NO WARRANTY WHETHER OF MERCHANTABILITY, FITNESS FOR PURPOSE, OR OTHERWISE is made beyond the repair, replacement, or refund of purchase price at the sole discretion of Texmate. Users shall determine the suitability of the product for the intended application before using, and the users assume all risk and liability whatsoever in connection therewith, regardless of any of our suggestions or statements as to application or construction. In no event shall Texmate's liability, in law or otherwise, be in excess of the purchase price of the product.

Texmate cannot assume responsibility for any circuitry described. No circuit patent or software licenses are implied. Texmate reserves the right to change circuitry, operating software, specifications, and prices without notice at any time.

TEXMATE INC

450 State Place • Escondido, CA 92029

Tel: 1-760-598-9899 • USA 1-800-839-6283 • That's 1-800-TEXMATE

Fax: 1-760-598-9828 • Email: sales@texmate.com • Web: www.texmate.com

Texmate has facilities in Japan, Taiwan, and Thailand.

For product details visit www.texmate.com

Local Distributor Address