



GI-50EB101 & GI-50TB101



TIGER FAMILY

**Programmable Meter Controllers
Tiger 320 Series PMCs
101 Segment Bargraph
5 Digit 1" LEDs
in a 9/32 DIN Case**

A powerful, intelligent, 5-digit, 101-segment Programmable Meter Controller (PMC) with modular outputs, input signal conditioning and advanced software features for monitoring, measurement, control and communication applications.

General Features

- The Tiger 320 Operating System supports an easy to use PC based Configuration Utility Program, which can be downloaded FREE from the web, and programming from front panel buttons.
- The T Version supports custom macro programs that can be easily produced with the Tiger 320 Macro Development System (available FREE on the web). The Development System enables programs to be written in BASIC, which can utilize any combination of the hundreds of functions and thousands of registers embedded in the Tiger 320 Operating System.
- Red, green, or superbright red 7-segment, 1" high LEDs with full support for seven segment alphanumeric text.
- Brightness control of LED display from front panel buttons.
- 101 segment red, green or tricolor bargraph that can display the signal from any of four channels or the result of a processed input signal.
- Modular construction with more than 120 interchangeable input signal conditioners and more than 25 interchangeable I/O modules.
- Up to 4 input channels with cross channel math for multi-channel processing.
- For applications where sensor excitation is required, modules are provided with 5V, 10V or 24 V DC voltage outputs.
- On demand tare, calibration and compensation can be initiated by the front panel program button.
- Autozero maintenance for super stable zero reading is provided for use in weighing applications.
- Programmable input averaging and smart digital filtering for quick response to input signal changes.
- Display text editing. Customize display text for OEM applications.
- Scrolling display text messaging on T meters with macros.
- Auto-sensing high voltage or optional low voltage AC / DC power supply.
- Serial output options include RS-232, RS-485, ModBus or direct meter-to-meter communications.
- Single or dual 16-bit Isolated Analog Outputs. Programmable 0~4 to 20mA or 0 to 10V for retransmission, 4-20mA loops to drive valve actuators, remote controllers & displays, multi-loop feedback and PID output. Scalable from 1 count to full scale.
- Dual independent totalizers to integrate input signals.
- 6 super smart, independently programmable setpoints with 8 selectable functions, including latching, deviation, hysteresis, register resetting, tracking and dual PID. Plus 7 programmable timer modes on all 6 setpoints.
- Setpoint tracking, setpoint latching and manual relay reset.
- Setpoints activated from any input, any register in the meter or from any digital input.
- Plug-in I/O modules include electromechanical or solid state relays, logic outputs or open collector outputs. 6 inputs & 16 outputs of opto-isolated I/O can be connected to an external DIN Rail terminal block module.
- Internal program safety lockout switch to prevent tampering.
- Peak & valley (max & min) with front panel recall and reset.
- Real time clock with 15 year Lithium battery backup.
- Data logging within the meter (up to 4000 samples with date/time stamp).
- Optional NEMA-4 front cover.

Input Module Compatibility

TIGER FAMILY: More than 120 different Plug-in I-Series Input Signal Conditioners are approved for the Tiger Family of meters.

See *I-Series Input Signal Conditioning Modules Guide (Z87)* for an up-to-date list.





Table of Contents

General Features	1	Functional Diagram	53
Specifications	2	Connector Pinouts	53
Tiger 320 Series Literature Overview . . .	3	Carrier Board Output Pins	54
Tiger 320 Series System Overview . . .	4-5	Relay and Logic I/O Modules	54
Planning to Use the Tiger 320	6-8	Component Layout & Ext. Devices . . .	55-56
Block Diagram of Tiger 320 Structure . .	9	I-Series Input Modules	57-63
Configuration Utility Program	10	Ordering Information	64-66
Custom Macro Program	11	Custom Faceplates	67
Index	12-13	Case Dimensions	68
Display Brightness	19-20		
Calibration Modes	21-24		
Programming Procedures	25-44		
Setpoint Programming Mode	45-51		
Registers	52		

Specifications

Display

- Digital Display:** 7-segment, 1" (25.4 mm) LEDs.
- Display Color:** Red (std). Green or Super-Bright Red (optional).
- Digital Display Range:** -19999 to 99999
- Update Rate:** 3 to 10 times per second
- Bargraph Display:** 101-segment bargraph.
- Bargraph Color:** Red (std). Green or Tricolor (optional).
- Display Dimming:** 8 brightness levels. Front Panel selectable
- Scrolling Display Text Messaging:** Full alphanumeric, 7-segment text characters supported on T Version with macros.
- Polarity:** Assumed positive. Displays - negative
- Decimal Point:** Front panel, user selectable to five positions.
- Annunciators:** 6 red LEDs on front panel; one per setpoint.
- Overrange Indication:** 
- Underrange Indication:** 
- Front Panel Controls:** PROGRAM, UP and DOWN.

Operating System (Tiger 320)

- Processor:** 32 bit with floating point maths (18.4 MHz).
- Flash Memory:** 64k, 4k for use by custom macros.
- RAM:** 1.25k and FeRAM 4k.
- EEPROM:** E Version 4k standard, T Version 32k standard. Memory upgrades available to 32k for LIN Tables and 1MB for Data Logging and custom macros.
- Registers:** 6144 registers comprised of 8, 16 or 32 bit signed, unsigned or floating point registers, implemented in a combination of RAM, FeRAM, Flash and EEPROM.
- Internal communication BUS:** 32 bit I²C BUS
- Real Time Clock (option):** Year:Month:Date:Hour:Minute:Second with 15 yr Lithium battery backup.
- Configuration:** Supports Front Panel Programming Codes and a PC-based Configuration Utility Program, which may be downloaded free from the web. T Version also supports custom macros.

Development System for Custom Macros

The Tiger 320 Macro Development System, which may be downloaded free from the web, can be used to create powerful macro software that allows Tiger 320 T Versions to be easily customized to suit any proprietary OEM application (see page 11).

Installed Application Software Includes

- Counter Functions:** Two built-in counters. UP counters, DOWN counters, UP/DOWN counters and high speed quadrature counters.
- Data Logging:** Logging with a date/time stamp, initiated at timed intervals, by activation of a setpoint, or manually. Data stored in internal 1MB EEPROM or in a removable 4 to 128M Flash Card Memory Module. Endless loop recording is supported.
- Input Compensation:** Provides compensation to the primary input channel (CH1) via channels 2, 3 or 4.
- Linearization:** 4 selectable 32 point or one 125 point flexible linearization tables are provided.
- Logic I/O:** 28 Macro programmable I/O ports supported.
- Manual Loader:** Front panel adjustable, 4 to 20mA or 0 to 10V isolated analog output.
- Math Functions:** Cross channel math functions to calculate the sum, difference, ratio or the product of two inputs.
- On Demand Functions:** Tare, compensation and calibration.
- Peak and Valley:** The meter can retain peak and valley (min/max) information and recall this on the front panel.
- Remote Setpoint Input:** Remote setpoint input via channel 2.
- Serial Output Protocols:** Selectable communication modes include ASCII, Modbus (RTU), Master Mode (for meter to meter communication) and an Epson compatible printer driver. DeviceNet and Ethernet optional output carrier boards are also supported.
- Setpoint Functions:** Six super smart setpoints with fully configurable hysteresis, on and off delays, one shot, pulse and repeat timers, latching, dual PID, setpoint tracking, resetting of registers, initiating of logging and printing.
- Signal Conditioning Functions:** Averaging, smart filter, rounding, square root, auto zero maintenance.
- Timer:** Timer functions supported in either time-up, time-down, or real-time clock modes.
- Totalizer:** Two totalizers for running total and batch totals of a process signal that can be accumulated over time.

Inputs

- Inputs Available:** More than 120 single, dual, triple and quad input signal conditioners available covering all types of analog, digital and mixed input signals (see page 57).
- Accuracy:** Tiger 320 PMCs enable the user to establish any degree of system accuracy required. Built-in compensation and linearization functions enable system accuracies of the order of $\pm 0.0001\%$ of reading for analog inputs. Stop -Start time resolution from $\pm 1\text{sec}$ to $\pm 0.7\text{nsec}$. Digital input and pulse counts ± 1 count.
- A/D Convertors:** A Dual Slope, bipolar 17 bit A/D is provided as standard on the main board. SMART modules can have 24 bit or 16 bit Delta-Sigma A/D convertors that utilize the internal I²C BUS.
- Temperature Coefficient:** Typically 30ppm/ $^{\circ}\text{C}$. Compensation can be utilized to achieve system temperature coefficients of 1ppm.
- Warm Up Time:** Up to 10 minutes, depending on input module.
- Conversion Rate:** Typically 10 samples per second. However, SMART input modules are available that can convert at 60, 240, 480 or 960 samples per second.
- Control Output Rate:** Can be selected for 100msec or 10msec. Some SMART modules have SSR outputs that react within 1.2msec.
- Excitation Voltage:** Depends on input module selected. Typically, 5V, 10V or 24VDC is provided.

Outputs (See pages 53-54 for pinouts and details of modular construction)

- Standard Carrier Board:** Is available without a serial output, or with either an isolated RS-232 or an isolated RS-485 (RJ-6 socket).
- Two Isolated Analog Output Options:** Mounted on any carrier board.
 - 1. Single Analog Output:** Fully scalable from 4 to 20mA or 0 to 20mA (or reverse) and selectable for 0 to 10VDC (or reverse).
 - 2. Dual Analog Output:** Fully scalable from 0 to 10VDC (or reverse).
 - Analog Output Specifications:** Accuracy: 0.02% FS. Resolution: 16-bit Delta-Sigma D/A provides 0.4 μA on current scaling, 250 μV on voltage scaling. Compliance: 500 Ω maximum for current output. 500 Ω minimum for voltage output. Update Rate: Typical 7 per second. Step Response: Typical 6msec to a display change. Scalable: From 1 count to full scale.

Seven I/O Modules: Plug into any carrier board from rear.

- 1. Four Relay Module:** Available in six combinations from one relay up to a total of two 10A Form C Relays* and two 5A Form A Relays**.
- 2. Four Relay Module:** Available with one to four 5A Form A Relays**.
- 3. Six Relay Module:** Available with five or six 5A Form A Relays**.
 - *Form C Relay Specifications:** 10A 240VAC~1/2 HP, 8A 24VDC. Isolation 3000V. UL and CSA listed.
 - **Form A Relay Specifications:** 5A 240VAC, 4A 24VDC. Isolation 3000V. UL and CSA listed.
- 4. Four Solid State Relay (SSR) Module:** Available with one to four independent (210mA DC only) or (140mA AC/DC) SSRs (400V max).
- 5. Six Output 5VDC / TTL or Open Collector:** Available with 0 to 5V or 0 to V+ (40VDC max).
- 6. Opto Isolated I/O Module:** Available in either 6 Outputs & 6 Inputs, or 16 Outputs and 6 Inputs. For connection to an external breakout box.
- 7. Flash Card Memory Module:** Available with 8 or 16 MB memory.

Power Supplies

- Auto sensing AC/DC (DC to 400Hz) hi volts std, low volts optional.
- PS1 (standard):** 85-265VAC / 95-370VDC @ 4W max 5W.
- PS2 (optional):** 14-48VAC / 10-72 VDC @ 4W max 5W.

Environmental (See Rear page for IP-65 & NEMA-4 options)

- Operating Temperature:** 0 to 50 $^{\circ}\text{C}$ (32 $^{\circ}\text{F}$ to 122 $^{\circ}\text{F}$).
- Storage Temperature:** -20 $^{\circ}\text{C}$ to 70 $^{\circ}\text{C}$ (-4 $^{\circ}\text{F}$ to 158 $^{\circ}\text{F}$).
- Relative Humidity:** 95% (non-condensing) at 40 $^{\circ}\text{C}$ (104 $^{\circ}\text{F}$).

Mechanical (See Rear page for more details)

- Case Dimensions:** 9/32 DIN, 144x72mm (5.69" x 2.84")
- Case Material:** 94V-0 UL rated self-extinguishing polycarbonate.
- Weight:** 11.5 oz (0.79 lbs), 14 oz (0.96 lbs) when packed.

Approvals

- CE:** As per EN-61000-3/4/6 and EN-61010-1.

Tiger 320 Series Modular Literature Overview

► The Tiger 320 Series, Modular Literature system, makes it easy to select detailed information about those specific functions required for your application and the Configuration of the Tiger 320 you intend using.

Copies of all Data Sheets / User Manuals and Supplements can be viewed page-by-page and/or downloaded from the document server on our website.

Programming Code Sheet

Generic to all Tiger 320 Series models, the Programming Code Sheet is a quick reference document that allows you to quickly view the meter's manual programming codes.

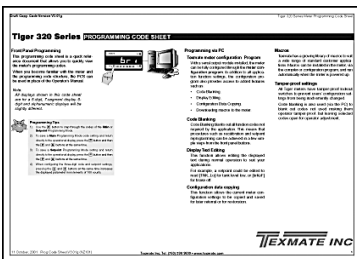

Shipped with each product ordered, copies are also available on request, or can be viewed and downloaded from the document server on our website.

Model Specific Data Sheet / User Manual



Specific to each 320 Series meter model, the data sheet / user manual describes the basic functions of the meter and how to configure the meter for these functions.

Shipped with each product ordered, copies are also available on request, or can be viewed and downloaded from the document server on our website.

The model specific data sheet / user manual contains:

- Technical Specifications
- Overview of Tiger 320 Series Software and Hardware
- Planning Guide
- Block Diagram of the Tiger 320 Software and Hardware
- Configuration Utility Program
- Custom Macro Programming
- Front and Rear Panel Controls
- Front Panel Button Manual Programming Codes Overview
- Programming Procedures
- Functional Diagram and Pinouts
- Hardware Layout and Available Input and Output Modules
- Meter Options, and Custom Faceplates
- Ordering Information

Supplements to Data Sheet / User Manual are Generic to all Tiger 320 Models

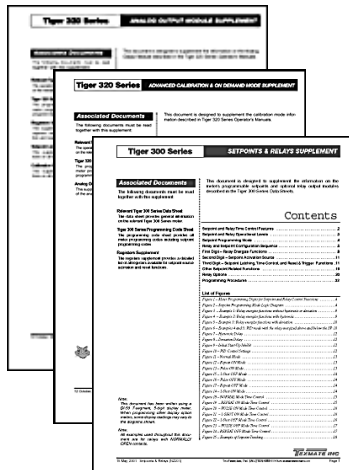

Generic to all Tiger 320 Series models, each supplement provides in-depth technical and procedural information on all individual meter modules, functions, or applications.

Listed are the supplements which are currently available:

Specific supplements are shipped with each product ordered to suit our customer's application. Copies are also available on request, or can be viewed and downloaded from the document server on our website.

- Advanced Calibration and On DEMAND Mode
- Analog Output Modules
- BASIC to Tiger 320 MACRO-Language Program Development System, Compiler and Tutorial
- Configuration Utility Program (Runs on PC)
- Linearizing Functions
- Meter Registers (for Macro Programming)
- Serial Communications Output Modules
- Setpoints & Relays
- Totalizing & Batching Functions

Other Tiger 320 Series Related Literature

Tiger 320 Functional Overview

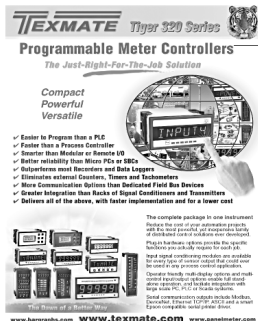

A Quick Overview of the Awesome Power of the Tiger 320 Series

Tiger 320 Application Examples



Describes a Selection of Tiger 320 Applications

I-Series Input Signal Conditioning Modules



Includes all Available Input and Output Modules for the Tiger, Leopard and Lynx Families of Meters

Smart Module Data Sheets

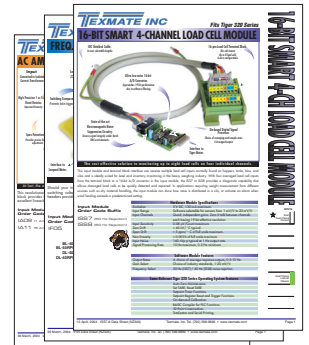

Data Sheets for All Smart Input and Output Modules

An Overview of the Awesome Power of the Tiger 320 Series

The Tiger 320 Series of 32-bit Programmable Meter Controllers incorporates, in one instrument, all the different functions required by today's automation and process control applications.

1 Tiger 320 32-Bit Operating System

A virtual toolbox of selectable and programmable application software functions are embedded in the Tiger 320 Operating System. They integrate seamlessly with a truly vast array of modular input and output hardware options.

Embedded Application Software Includes:

- Multi-channel Inputs In Many Combinations
- Full Floating-point Maths
- Cross Channel Math (A+B, A-B, AxB, A/B)
- Square Root, Inverse and Log of Input
- 4 x 32 Point Or 1 x 125 Point Linearization Table
- Smart Auto Zero with Programmable Capture Band, Rate of Change and Aperture Window for Weighing Applications
- Set Tare Reset Tare for Batching
- Smart Quick Response Averaging
- Smart Timer and Time Integration Functions
- Time and Event-based Sequencing
- Polynomial Calculations
- Remote Reset of Any Function
- Dual Totalizers
- Dual PID

2 Data Logging and Memory Options

Up to 1MB of non-volatile on-board memory can be installed for (Black Box) endless loop recording. Up to 4000 data records can be continuously stored to provide before and after analysis of any process fault condition.

- Data log from 4 channels.
- Data log from 2 channels with date & time stamp.
- Log / print from setpoint or timer.

A Plug-in I/O Module is available with removable Flash Card Memory for high-capacity or long-term data logging.

Flash Cards are : to 128 Meg.

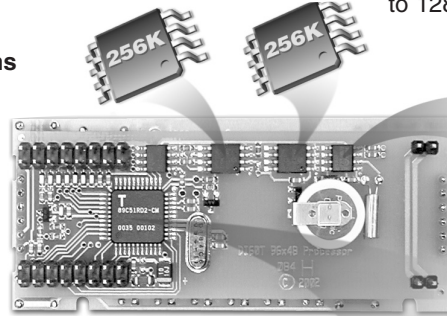
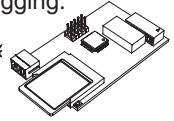

3 Real-time Clock



Optional Real-time clock with date and time stamp. 15 year lithium battery.

4 Powerful Custom Macro Programming Capability

Texmate's BASIC to Tiger 320 Macro-language Compiler can quickly Convert your special metering, control and automation ideas into reality.

This powerful easy to use development system enables programs to be written in BASIC utilizing any combination of the hundreds of functions and thousands of registers embedded in the Tiger 320 Operating System. When your BASIC program is compiled into the Tiger 320 Macro-language it is error checked and optimized. There are also numerous off-the-shelf application specific programs available. Many only need the blanks to be filled in to use them and this does not require any knowledge of BASIC.



Scrolling annunciator messages can be programmed to appear with any setpoint activation, selected events or logic inputs.



5 Programmable Front Panel Controls

Programmable Front Panel Controls

The front panel buttons can be used to control or program any standard functions.

They can also be programmed to only access and display specifically designated functions, such as Tare, Auto-Cal or Print on Demand.

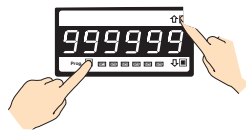

6 Configuration & Programming from a PC

PC Programming

Program the meter from a PC with Texmate's easy to use Tiger 320 Configuration Utility Program.

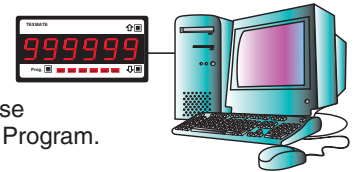

7 A Wide Selection of Display Formats & 8 Case Sizes to Suit any Application

Single or multiple LED or LCD displays
Numeric, Alpha Numeric and Bargraph

144x72mm 9/32 DIN

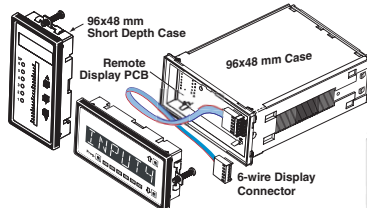

96x48mm 1/8 DIN



48x96mm 1/8 DIN



36x144mm 9/64 DIN

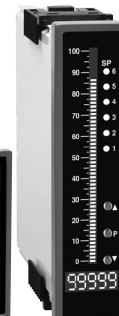

648x144mm 4" LED Remote Display 5 or 6 digit Driven by RS485 from any Tiger 320



8 22 Opto-Isolated I/Os on Plug-in Module & 6 Onboard Programmable I/O Logic Ports

- 6 Inputs & 16 Outputs or 6 Inputs & 6 Outputs
- Fully Programmable



Connects to DIN Rail terminal block module with 3M IDC cable

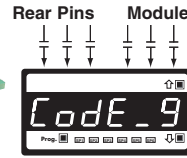

Three logic level inputs are provided on the module input header and three rear input pins are provided that can be programmed to STOP/START/RESET almost any function including: set tare, reset tare, relays, totalizers, print output, data logging, peak, valley, or any register from an external contact closure.

9 6 Super Smart Setpoints - 8 Selectable Functions - 7 Programmable Timer Modes

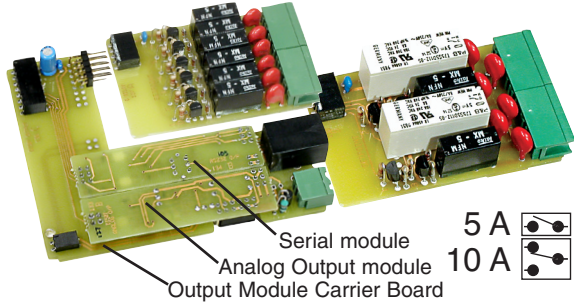

Serial module
Analog Output module
Output Module Carrier Board

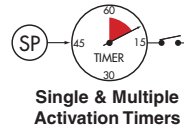

Single & Multiple Activation Timers

7 Multi Function Interval Timers on all 6 setpoints

- Normal.....Adjustable Delay On Make / Adjustable Delay On Break
- 1-Shot ON.....Adjustable Delay On Make / Adjustable Min ON-Time
- 1-Shot OFF.....Adjustable Delay On Break / Adjustable Min OFF-Time
- Pulse On.....Adjustable Delay On Make / Adjustable Max ON-Time
- Pulse Off.....Adjustable Delay On Break / Adjustable Max OFF-Time
- Repeat ON.....Adjustable ON-Time / Adjustable OFF-Time
- Repeat OFF.....Adjustable OFF-Time / Adjustable ON-Time

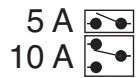

5 Amp and 10 Amp Relays or optional SSR Outputs can be energized above or below setpoints.

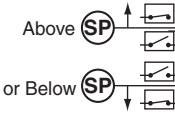

Activation

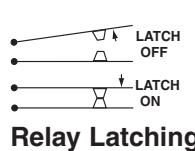

Relay Latching

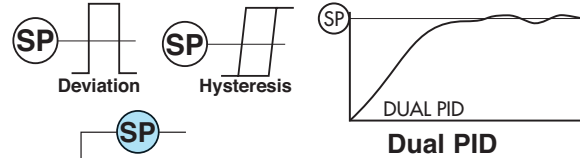

Dual PID



10 Scrolling Annunciator

Scrolling Annunciator up to 99 Characters long is available on all 6 setpoints for Alphanumeric Displays with Fill-in-the-blanks Macro.



12 16-bit Isolated Analog Outputs

Single

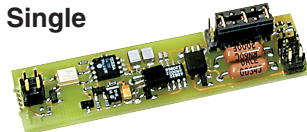

0 ~ 4-20mA or 0-10V

Dual

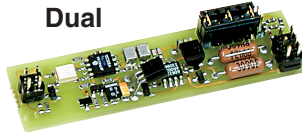

0-10V & 0-10V

Programmable 0~4 to 20 mA or 0 to 10 V for retransmission, 4-20 mA loops to drive valve actuators, remote controllers & displays, multi-loop feedback and PID output.

11 Serial Communications & Printer Output

RS-232

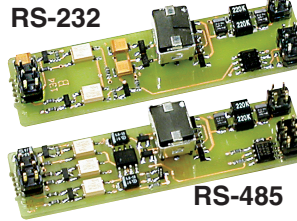

RS-485

Selectable Communication Modes include:

- ASCII
- Modbus
- Ethernet (TCP/IP)
- DeviceNet (with optional carrier board installed)

Interface directly with PCs (using Window's terminal program), PLCs, or any Epson compatible serial printer.

Serial Printer Output

Smart printer driver makes simple serial printers look intelligent.

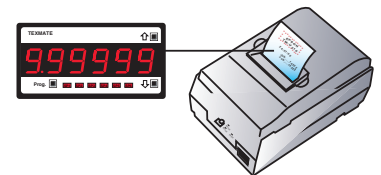

Meter to Meter Communication.

Direct meter to meter communication enables two meters to share data and resources.



13 Auto-sensing AC/DC Power Supply

- High Efficiency CE tested Auto Sensing AC/DC power supplies
 - Standard 85-265 Volt AC / 95-370 Volt DC
 - Low Voltage 9-32 Volt AC / 10-60 Volt DC

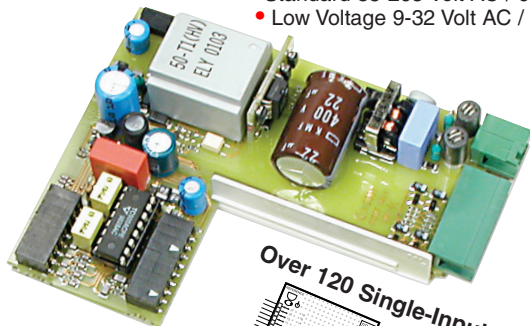

14 Over 120 Different Input Signal Conditioning Modules

- Choose from over 120 different single, dual, triple and quad input signal conditioners.
- Mixed function and smart modules with their own A/Ds, co-processors, SSRs and I²C Bus outputs are available to suit almost any application.

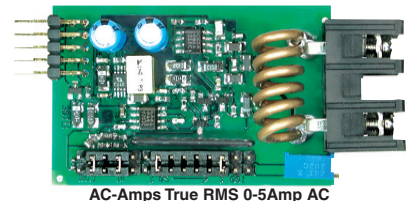

AC-Amps True RMS 0-5Amp AC

Over 120 Single-Input, Dual-Input, Triple Input and Quad-Input signal conditioners work with the Tiger 320 series

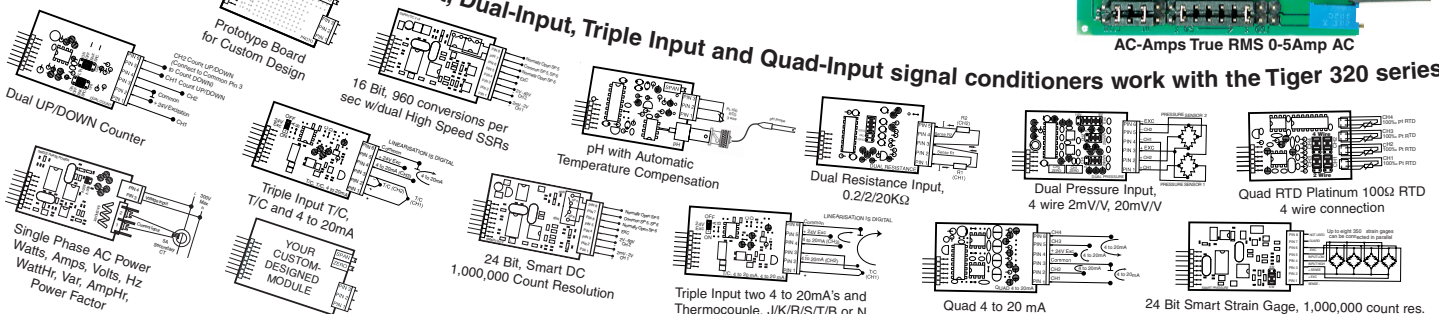

Planning to Harness the Power of Tiger 320 Programmable Meter Controllers

A combination of modular hardware and software resources enable Tiger 320 Series Programmable Meter Controllers (PMCs) to be easily configured as a cost effective solution for the most simple or the most complex of applications.

A review of your Project's objectives, its physical layout, the proposed sensors and control outputs will enable you to select the optimum configuration of the Tiger 320 PMC's unique hardware and software capabilities.

Input Signals & Sensors

4-20 mA or Sensor Direct

Unless sensors are located at a far distance, the greatest accuracy and best performance is usually obtained by connecting sensors directly to the Tiger 320, which will then function as the primary measurement device.

PLANNING TIP There are more than 120 Tiger compatible input signal conditioning modules, with the appropriate excitation outputs, to suit almost any type of sensor or combinations of up to 4 sensors.

In most cases, sensors with a 4-20 mA output are more costly, and when a separate 4-20 mA transmitter is used, signal conversion, drift, and calibration inaccuracies are introduced.

PLANNING TIP Some Tiger input modules combine direct sensor inputs with 4-20 mA inputs, enabling both local and far distant sensor inputs to be combined.

Sensor Linearization or Compensation

The performance of many sensors can be greatly enhanced or expanded with linearization and or compensation. Sensors may be compensated for temperature, frequency, altitude, humidity and mechanical position, to name just a few parameters.

PLANNING TIP Tiger PMCs with 32 kilobits or more of memory provide up to four 32-point user defined linearization tables or one combined 125-point table.

PLANNING TIP Many compensation methods can be implemented with the standard cross channel math capabilities of the Tiger's 32-bit operating system. Complex three-dimensional compensation can also be implemented using the powerful macro programming capability.

PLANNING TIP The serial number and calibration date of a sensor can be loaded into the meter. The serial number, linearization tables, and compensation factors of a newly calibrated sensor can then be saved for future reloading, either serially through a PC or directly through the web via an Ethernet port.

PLANNING TIP Although there are numerous input modules with combinations of various input signals, some inputs such as watts or pH are provided on input modules dedicated to a single function. Combining these inputs with each other signals two or more Tiger meters can serially communicate, and be configured to share their data and processing resources.

Display Options

Tiger PMCs have a large range of display options, including digital and alphanumeric LCDs, LEDs, and Touch Panel HMIs.

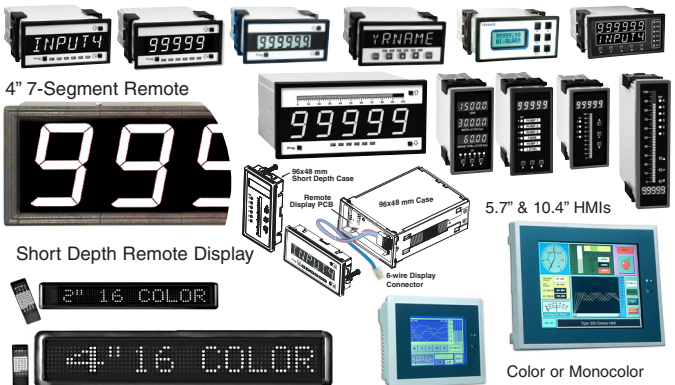

LED or LCD Displays

LED displays are a lower cost and popular display option. They operate over the largest temperature range, have better viewing angles and viewing distances, and have the longest operational life. However, red LEDs are difficult to read in direct sunlight without a shade hood and consume more power. Green LEDs and backlit LCD displays can be more easily read in direct sunlight.

PLANNING TIP The Tiger range can be ordered with red or green LEDs. LCD displays are also available, with or without backlighting.

Numeric or Alphanumeric Displays

Generally, numeric displays are a lower cost option than alphanumeric displays. The Tiger range supports a full 7-segment numeric and 14-segment alphanumeric alphabet of English letters and Arabic numerals. Where complex text messaging or alarm annunciation is required, we recommend using the 14-segment alphanumeric option.

Single or Multiple Display

The Tiger meter has four input channels and can be configured to display many different inputs or results. These can be viewed constantly on the operational display, or on demand in one of the view modes by pressing a button. Some applications require multiple values to be displayed simultaneously. With single, dual, or triple displays, and single displays with 51 or 101-segment bargraph combinations, we have a large range of display options to choose from.

PLANNING TIP Tiger meters can communicate with each other to share their data and processing resources and be stack or twin mounted to provide a wider range of display options.

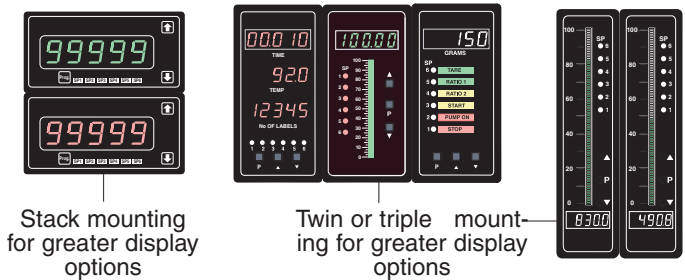

Push Button or Membrane Touch Pads

Tiger PMCs are shipped as standard with high usage hard plastic push buttons. An optional clear lens cover that opens on a cam hinge with a key lock can provide full NEMA 4 or IP65 dust and water proofing. Alternatively, an optional membrane touch pad faceplate can be ordered.

PLANNING TIP Faceplates can be customized to suit any OEM application, and be quickly produced in large or small quantities for push buttons or membrane touch pads.

Control Outputs & I/O Logic

Electromechanical Relays or Solid State Control Outputs

Tiger PMCs have a wide selection of control outputs to choose from. The decision on which control output to choose depends on the current and the switching frequency.

Electromechanical relays are a popular choice for most control outputs. Tiger output modules are available with combinations of two 10 amp form C and two to six 5 amp form A relays that can be used to directly drive fractional HP motors or actuators.

PLANNING TIP The limitation of electromechanical relays is switching speed. If a relay needs to operate in less than 30 mS, or be cycled faster than .5 cpm, it is advisable to select an output module with solid state relays (SSR) or open collector outputs (OC), that can drive external high current SSRs.

DECISION **PID or On/Off Control**

Depending on the process to be controlled, either PID or on/off control should be selected. If the process variables are reasonably consistent, then the on/off control is generally more than adequate and easier to implement. Super smart setpoint control software supports many selectable functions, such as Hi or Lo activation, Latching, Hysteresis, Tracking, Register Resetting and 7 Multi-function internal Timers on all setpoints.

Control systems with large lag and lead times are not suitable for on/off control and tend to overshoot and undershoot. PID is needed to stabilize and control these systems. One of the many powerful setpoint functions provided by the Tiger 320 Operating System is single or dual PID.

RETRANSMISSION TIP **Retransmission 0-10V or 4-20mA**

Tiger PMCs can have an optional single (0-10 V or 0/4-20 mA) or dual (0-10 V) analog output module installed. The isolated 16-bit output is fully scalable and highly accurate. With a compliance of up to 500Ω at 20mA, the 4-20 mA output can be used over very long distances and still drive more than one output device, such as a PID controlled valve positioner.

The analog outputs can be reversed to output 20mA to 4/0 or 10 to 0VDC. They can be scaled across any portion of the digital range, up to full scale. The output can be programmed to swing 0 to 20mA or 0 to 10V in one digital count to drive external logic or SSRs as additional setpoints. Under Macro Program Control, the analog outputs can be programmed to produce pulses or even sinewaves.

DECISION **I/O Logic, Rear Panel or Breakout Box**

The Tiger Operating System has many built-in logic functions that can be used to develop sophisticated control systems. The Tiger PMC has three logic inputs/outputs available via the LOCK, HOLD, and CAPTURE pins, and three logic I/Os are available for input module use via pins D1, D2 and D3.

More complex I/O intensive applications require an opto-isolated I/O plug-in module, which supports six inputs and up to 16 outputs. This module can connect to an external Breakout Box that is DIN Rail mountable with screw terminal blocks. There are also compatible DIN Rail mounting electromechanical relays and SSR modules.

- 6 Inputs & 16 Outputs or 6 Inputs & 6 Outputs
- Fully Programmable

Connects to DIN Rail terminal block module with 3M IDC cable



Serial Communication

The easiest way to configure or program a Tiger PMC is with the free user-friendly Configuration or Macro Development Software. Serial I/O is provided via an optional Plug-in output carrier board, which supports RS-232 or RS-485 output modules. If serial I/O is not required by the application, the serial carrier board can be removed for reuse. The Tiger 320 Operating System supports several serial protocols, including ASCII, Modbus RTU and Print Mode (which includes a printer driver and support for direct meter to meter communications). Also supported is DeviceNet, which requires a special dedicated carrier board, and Ethernet (TCP/IP), which requires an external converter box.

DECISION **RS-232 or RS-485**

Except for DeviceNet, all serial communication modes supported by the Tiger can function with either RS-232 or RS-485. The limitations of RS-232 are that only one meter at a time can be connected to the serial port of a computer, and the distance from the computer to the meter is limited in practical

terms to around 30 meters (100 feet).

Up to 32 meters can be connected on an RS-485 bus. The differential current drive of the RS-485 bus ensures signal integrity in the most harsh environments to distances up to 1230 meters (4000 feet). However, RS-485 generally requires a special RS-485 output card to be installed in the computer or an external RS-232 to RS-485 converter has to be used.

DECISION **Select the Communication Mode Best Suited to Your Application:**

Modbus (RTU)

Modbus is widely used in industry. It has a large base, and most SCADA and HMI software packages support it. See also Modbus Wrapped in Ethernet (Modbus/TCP) below.

There are 100s of HMI Touch Panel Screens that are compatible with the Tiger 320 Modbus interface.



ASCII

The meter configuration utility program and the development software use the ASCII protocol. The ASCII protocol allows you to write your own driver for your own application via the development software and should provide the quickest development time.

Print Mode

This is an ASCII based printer driver output that enables the serial port to be directly connected to any serial printer with Epson compatibility. Printer output can be configured to occur from a setpoint or on demand, and can be date or time stamped.

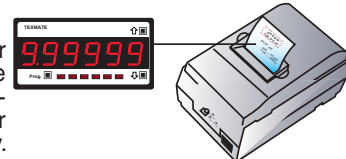

The print mode can also be used for computer data logging applications. The meter can be connected directly to a computer, set up in Microsoft Hyperterminal mode, with the meter programmed to output directly into a Microsoft Excel spreadsheet format. (Also see Data Logging).

Print Mode for Meter to Meter Communication

Two or more Tiger PMCs can be connected together allowing data to be transferred from the master meter (in print mode) to the slave meter (in ASCII mode). This enables the meters to share input data and control output functions.

Master Mode

This mode is for use with macro programming to expand the meter to meter communication capability to multiples of Tiger PMCs. This is useful for building an entire system of Tiger PMCs, sharing information and control output resources.

DECISION **Ethernet**

Ethernet has become a popular automation and control protocol. We supply an ethernet output option and several external ethernet converters that are compatible with the serial outputs of Tiger PMCs.



ETHERNET ASCII WRAP - The ethernet output carrier board option wraps the ASCII output into the Ethernet protocol, and provides a T-base 10/100 Ethernet output socket.

This allows the Configuration Utility Program or the Macro Development Software to run over a standard Ethernet network. This enables the Tiger meter to be configured or macro programmed from anywhere in the world via the web.

Up to 32 Tiger PMCs can be connected by RS-485 to a single Ethernet Converter, which will support up to 32 separate IP addresses.

ETHERNET MODBUS WRAP - This converter accepts the Tiger PMC's modbus protocol and outputs Modbus/TCP through an Ethernet T-base 10 port. This has become a standard for Ethernet on the factory floor. Many SCADA and HMI software packages connect directly to Modbus/TCP.

DeviceNet

DeviceNet was originally developed by Allen Bradley to connect sensors from the factory floor to PLCs. It is a deterministic real-time system, typically used to connect to networks using Allen Bradley PLCs. An optional carrier board is required for DeviceNet which replaces the standard serial output with a dedicated DeviceNet output connector.

Data Logging

The Tiger 320 Operating System has built-in, sophisticated data logging software. Data logging can be triggered from the PROGRAM button, digital inputs, time or alarm functions. Up to 1MB of optional extra on-board memory provides a powerful, multichannel data capture and acquisition system.

Tiger PMCs can be configured to log in an endless loop, overwriting the oldest data first and utilizing the maximum amount of memory available. Similar to the Black Box on an aircraft, the data can be downloaded for analysis after a problem event occurs.

Data logging can be combined with an Ethernet converter to provide an individual Web Page with data that can be accessed by a browser over the internet.

Real-time Clock

The Tiger meter has an optional real-time clock with a 15 year lithium battery backup, ensuring that time information is not lost in the event of a power failure. It can be configured in 12 or 24-hour modes for printing and data logging applications.

Other applications of the real-time clock include activating a setpoint or control action at fixed times of the hour, day, week, month or year.

Flash Card Memory Module

For long term data logging, a Flash Card Memory Module that plugs in to the carrier board output socket is available. Flash Cards are available from 4 to 128 meg. They can be removed and read by a standard card reader, or the data can be downloaded through the serial port or over the internet with an Ethernet converter. The module also has an SSR setpoint output to trigger an external event.

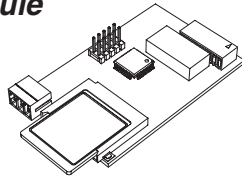

Configuration and Programming with a PC

With a serial output module installed, Tiger 320 PMCs are most easily configured using the Tiger 320 Configuration Utility, which can be downloaded free from the web and run on any Windows-based PC. The utility also enables the user to access some special capabilities of the Tiger 320 which cannot be programmed manually by the front panel buttons.

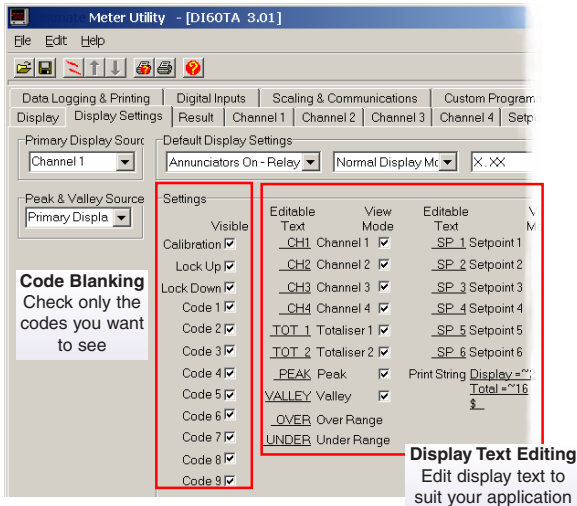

The Configuration Utility requires that an RS-232 interface board be installed in a Tiger 320 for programming. However, if the final application does not require a serial output, the RS-232 board can be easily removed, after programming is completed, and kept for future use.

When a Tiger 320 is to be used in a custom application, the utility enables all or any of the front panel programming functions to be disabled (code blanking). Customized descriptive text can also be entered to appear with any setpoint action or event.

Different configurations can be stored in a PC for fast downloading into a meter by the user. Custom configurations can also be issued a serial number and preloaded at the factory.

Development Software

Custom Macro Programming

This powerful, easy to use development system enables programs to be written in BASIC, utilizing any combination of the hundreds of functions and thousands of registers embedded in the Tiger 320 Operating System. When your Basic program is compiled into the Tiger 320 Macro-language it is error checked and optimized. There are also numerous off-the-shelf application specific programs available. Many only need the blanks to be filled in to use them and do not require any knowledge of BASIC programming.

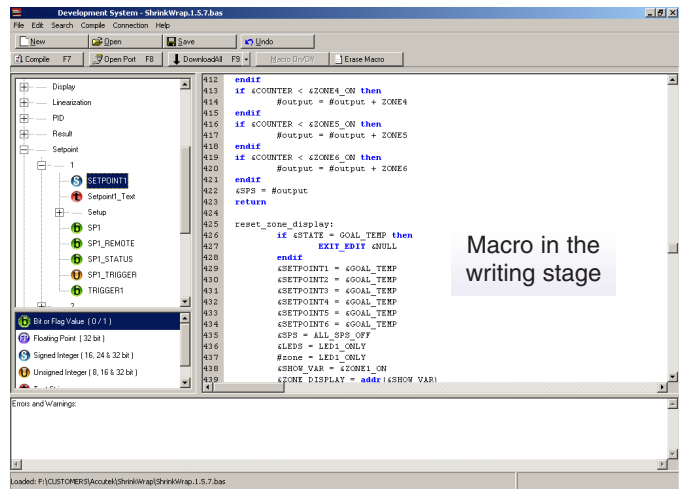

Macros are useful when implementing any specialized control system that cannot be achieved by the standard configuration capability of the Tiger 320 Operating System. Using the development software, functions can be altered or added in a standard meter to perform the required job. This may typically include logic sequencing functions and mathematical functions.

Developing a Macro is much easier and quicker than programming a PLC, because the basic code required to customize the Tiger meter is considerably less than the ladder logic programming required for PLCs. This is due to the hundreds of functions built into the Tiger meter that can be manipulated or invoked by a macro, to fulfill the requirements of almost any application.

Scrolling annunciator messages can be programmed to appear with any setpoint activation, selected events or logic inputs. Easy to read, plain text prompts can be programmed to replace the manual programming codes and provide a user-friendly interface for any custom application.



Block Diagram of the Tiger 320 Software and Hardware Structure

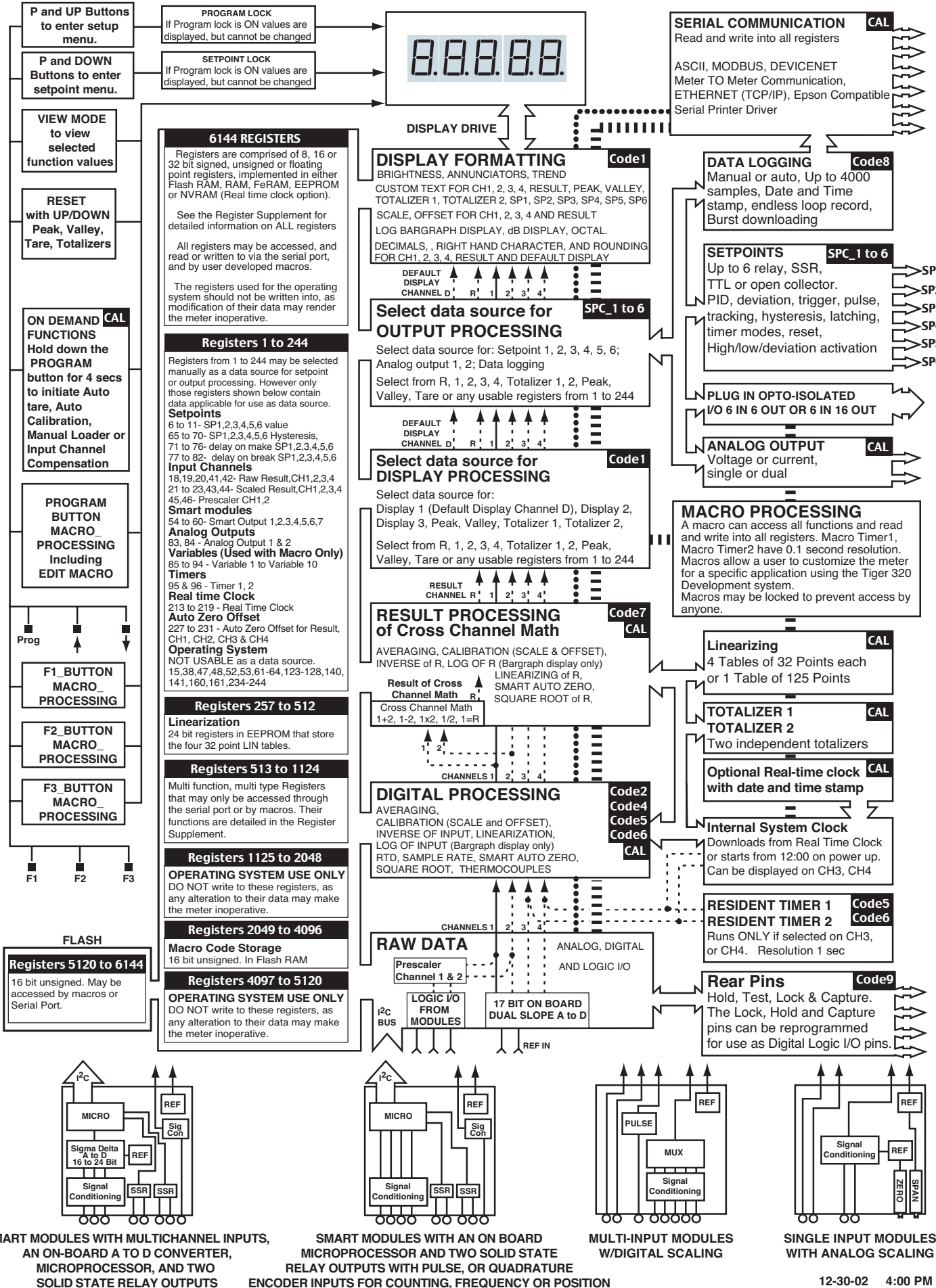

The Easiest and Fastest Way to Configure the Tiger 320 is to Use a PC with the Free Downloadable Configuration Utility Program

The diagrams and instructions provided in this data sheet / user manual are intended to enable the Tiger meter to be configured and programmed manually using the front panel buttons. A system of Programming Codes is required to facilitate this type of manual programming and these are explained in detail with diagrams and examples.

However, when the Tiger meter is configured and programmed via the optional RS-232 serial port and a PC using the Configuration Utility, the system of Programming Codes is bypassed. The Configuration Utility enables all the programming options to be clearly identified by their functions for direct on-screen selection. The Configuration Utility requires that an RS-232 interface board be installed in a Tiger 320 for programming. However, if the final application does not require a serial output, the RS-232 board can be easily removed, after programming is completed, and kept for future use.

The Configuration Utility Program (which may be freely downloaded from the web) is designed to simplify and speed up the configuration and programming of any Tiger 320. Pull down menus facilitate the selection of different options and the assignment of values. A "Help" explanation is provided just by holding the cursor over any function box.

The configuration utility enables the user to access some special capabilities of the Tiger 320 which cannot be selected manually by the front panel buttons.

Source For Display

- OFF Primary Display
- Result Channel 1
- Channel 2
- Channel 3
- Channel 4
- Totalisator 1
- Totalisator 2
- Peak Valley
- Tare
- Setpoint 1
- Setpoint 2
- Setpoint 3
- Setpoint 4
- Setpoint 5
- PID 1
- PID 2
- Register

Annunciators

- Annunciators On - Relay ON
- Annunciators On - Relay OFF
- Annunciators OFF
- Annunciators show tendency

Display Mode

- Normal Display Mode
- Manual Display Mode
- Fast Display Mode

Decimals and Display Format

- No decimal point
- X.X
- X.XX
- X.XXX
- X.XXXX
- X.XXXXX
- External decimal point
- 12 Hour Clock
- 24 Hour Clock
- Hrs : Mins : Secs
- Days : Hrs : Mins
- Octal

Last Digit Rounding

- None
- 2 x
- 5 x
- 10 x

Right Hand Side Character

Source For Peak and Valley

- OFF Primary Display
- Result Channel 1
- Channel 2
- Channel 3
- Channel 4
- Totalisator 1
- Totalisator 2
- Peak Valley
- Tare
- Setpoint 1
- Setpoint 2
- Setpoint 3
- Setpoint 4
- Setpoint 5
- PID 1
- PID 2
- Register

Code Blanking

Check only the codes you want to see

Display Text Editing

Edit display text to suit your application

Code Blanking

When a custom configuration is created for any specialized application, the Tiger 320 can be programmed to blank out and disable all or any manual programming codes that you do not wish the user to be able to view or access by de-selecting them in the appropriate check box.

Display Text Editing

The meter can be programmed to display customized text to appear for any setpoint or event to suit any application requirements.

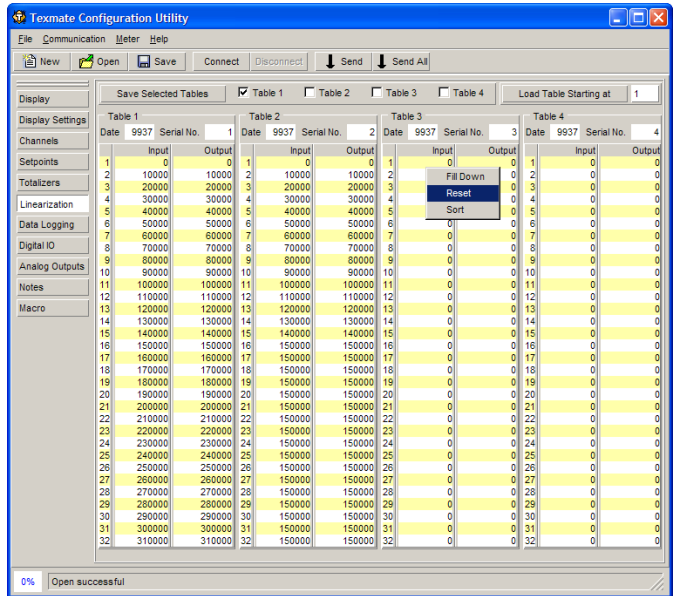

Easy Installation of Linearization Tables

The configuration utility facilitates the storage and downloading of complex linearization tables. Tables can be created in any mathematical or spreadsheet program, and copied into the utility. Linearization tables can be created to precisely match a particular sensor so that they can be installed and downloaded as part of an annual calibration procedure.

The screenshot shows the 'Setpoints' section of the Configuration Utility. It displays a table with columns for Name, Source, Register, Value, Relay, and Activation. Callouts point to various settings:

- Source For Setpoints 1-6**: Points to the 'Source' column.
- Mode For Setpoints 1-6**: Points to the 'Mode' column.
- Timer For Setpoints 1-6**: Points to the 'Timer' column.
- Latching For Setpoints 1-6**: Points to the 'Relay' column.
- Activation For Setpoints 1-6**: Points to the 'Activation' column.

Destination

- OFF Primary Display
- Result Channel 1
- Channel 2
- Channel 3
- Channel 4
- Totalisator 1
- Totalisator 2
- Peak Valley
- Tare
- Setpoint 1
- Setpoint 2
- Setpoint 3
- Setpoint 4
- Setpoint 5
- Setpoint 6
- PID 1
- PID 2
- Register

Reset Mode

- Reset Value
- Constant
- Input-SP+Const.
- Dist+Const.
- Display
- Result Channel 1
- Channel 2
- Channel 3
- Channel 4
- Totalisator 1
- Totalisator 2
- Peak Valley
- Tare
- PID 1
- PID 2
- Register

Easy Setpoint Configuration

The Tiger 320 supports an incredible range of setpoint options and functions. The utility makes it quick and easy to select and download any combination you may require.

Configuration Data Copying and Loading

The configuration utility program allows you to store a record of a meter's configuration for later referral, or for the restoration of a desired configuration. Macros can be combined with a configuration file so they can be downloaded together and locked at the same time. When a file is locked after downloading, it cannot be copied. It can only be erased and reloaded from a master file.

Also included is the ability for the user to make notes about the configuration that can be stored as part of the file.

Never Before has the Customization of such a Powerful Measurement, Control and Automation Product been Made so Fast, Free and Easy

The Tiger 320 Macro Development System is so power packed and feature rich that you can build a completely custom designed controller in 1/50th of the time it would take to program a microprocessor or a PC, and 1/20th of the time it can take to program a PLC.

Quickly convert any special metering or control and automation idea into your own proprietary product, CE approved and ready to ship in days, with custom multicolor faceplates, labels, shipping boxes and instruction manuals.

This powerful, easy to use Development System can be downloaded free from the web. It enables programs to be written in BASIC, which can utilize any combination of the hundreds of functions and thousands of registers embedded in the Tiger 320 Operating System.

When your BASIC program is compiled into the Tiger 320 Macro-language it is error checked and optimized. When your Macro is downloaded into a Tiger 320 and locked, it is locked forever. It cannot be read or duplicated, it can only be erased. There is no back-door access. A Tiger 320 running your Macro will remain your exclusive proprietary product.

There is also a growing library of off-the-shelf application specific macro programs available. Many only need the blanks to be filled in to use them and this does not require any knowledge of BASIC. The source code is provided with these programs so they can easily be customized and/or integrated into any proprietary application-specific Macro.

On request, any custom Macro can be issued a serial number and pre-installed at the factory to operate on power-up.



Scrolling annunciator messages can be programmed to appear with any setpoint activation, selected events or logic inputs. Easy to read, plain text prompts can be programmed to replace the manual programming codes and provide a user-friendly interface for any custom application.

Tiger Development System - Code Writing Screen

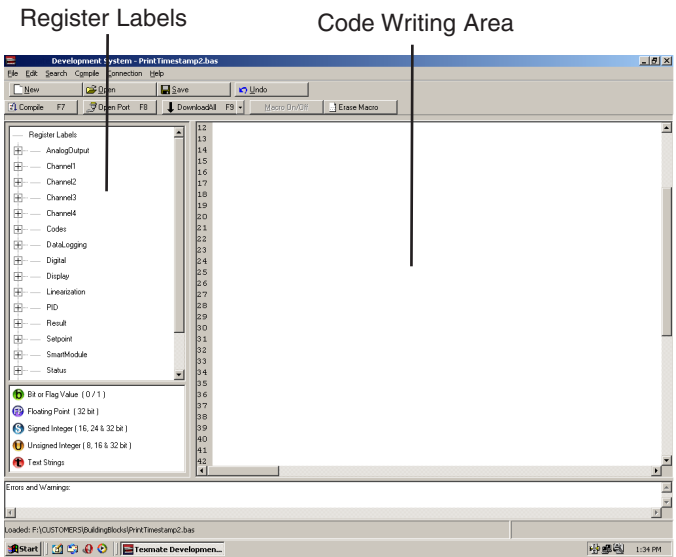

Tiger Development System screen showing Macro being written.

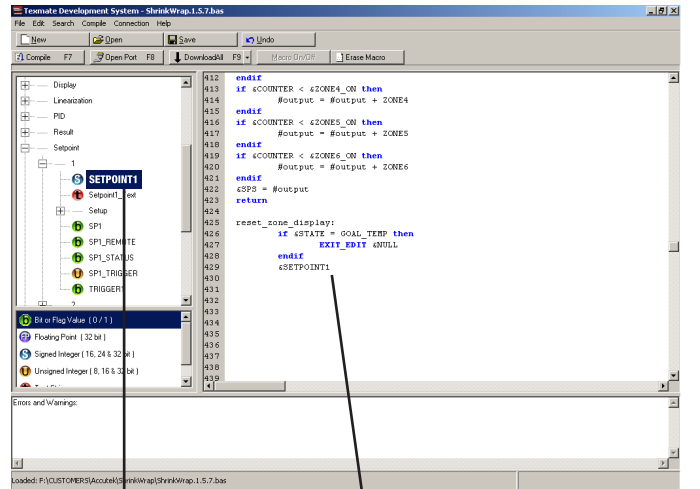

Double clicking on register label in the left hand side frame automatically inserts the function in the code window at the cursor insertion point.

Tiger Development System screen showing the Macro code being compiled successfully.

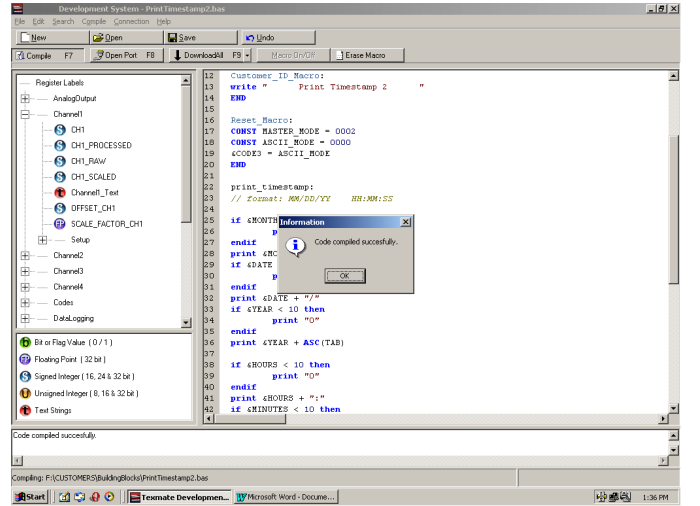

Tiger Development System screen showing the compiled Macro being downloaded into a Tiger 320 Series PMC.

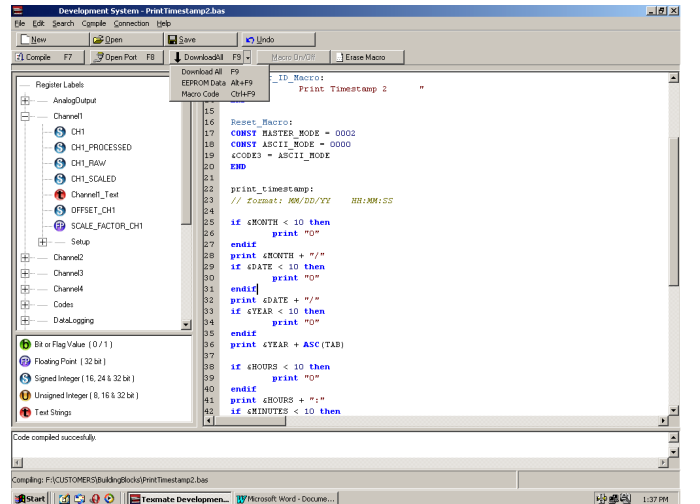

32-Bit Operating System	4	Code 6 - Channel 4 Functions	42
Analog Output / Analog Retransmission	21-22	Code 7 - Result Processing	43
Calibration of Analog Output.....	21	Code 8 - Data Logging & Print Mode	44
Dual (0-10V) Analog Output.....	21	Code 9 - Functions for Digital Input Pins	44
Location of Analog Output Module	55	Code 10 - Bargraph Display Configuration	26-28
Pinout of Analog Output.....	54	Functions for Digital Input Pins	51
Scaling of Analog Output	21, 22	Code Blanking	19-20
Select Source for Analog Output	21	Clock/Timer	
Auto Zero Maintenance for Weighing Applications	22	Configuration	38, 41, 42
Set Parameters for CH1, CH2, CH3 & CH4	21	Optional Real-time Clock	4
Averaging - Digital Filtering	22	Real-time Clock Configuration	38, 41, 42
Set Parameters for CH1, CH2, CH3 & CH4	21	Real-time Clock Date	44
Block Diagram of Software & Hardware	9	Time Stamp.....	44
Brightness Display	20	Component Layout & External Devices	55-56
Calibration	21-24	Modular Construction.....	55
Calibration Thermocouple or RTD	21	Component Layout.....	56
Manual Calibration	23	Configuration and Programming from a PC	4, 8
Single-Point Calibration.....	23	Configuration Utility Program	
Two-Point Calibration	23	Code Blanking and Display Text Editing	10
Case Dimensions	68	Configuration Data Copying.....	10
Modular Construction.....	55	Installation of Linearization Tables	10
Other Case Sizes.....	3, 4	Setpoint Configuration.....	10
Channel 1 Settings	38-39	Connections	
32 Point Linearization.....	39	Carrier Board Output Pinouts.....	54
Analog Input Signal Sample Rate.....	38	Connector Pinouts.....	53
Counter/Resident Timer/Clock	38	External Devices	55
Measurement Task	38	Ordering Information, Connectors.....	66
Post Processing	39	Rear Panel Pinout Diagram	53
Print Mode.....	39	Controls & Indicators	14-15
Sampling Rate.....	38	Annunciator LEDs	14
Serial Mode.....	39	Down Button.....	14
Smart Input Module.....	38	Error Message.....	15
Channel 2 Settings	40	LED Display.....	14
Channel 3 Settings	41	Program Button	14
Channel 4 Settings	42	Program Lockout Switch	15
Channel 1 & Channel 2 Results Processing		Scrolling Display Text Messaging.....	14
32 Point Linearization.....	43	Setpoint Lockout Switch.....	15
Maths Functions.....	43	Seven Segment LED Displays	14
Code 1 - Display Configuration	25-37	Up Button	14
Configure Bargraph Colors Procedure.....	35	Control Outputs	6-7
Configure Bargraph Using Linear Scaling Procedure.....	36	Electromechanical Relays	
Configure Bargraph Using Logarithmic Scaling.....	37	or Solid State Control Outputs	6
Configure Data Source Procedure.....	31	I/O Logic, Rear Panel or Breakout Box	7
Configure Display Format Mode Procedure.....	32	PID or ON/OFF Control.....	7
Configure Last Digit Text Char. Procedure.....	33	Retransmission 0-10V or 4-20mA.....	7
Configure Setpoint Annunciators Procedure.....	34	Custom Macro Programming	
Configure Update at Sample Rate Procedure	34	Macro Compiling and Loading	11
Data Source - 2nd Digit [X5X].....	25	Data Logging	4, 8, 44
Display Format - 2nd Digit [X6X].....	25	Downloading Logged Data from Meter	44
Display Functions Mode.....	25	Flash Card Memory Module	8
Manual Loader Mode	25	Printing Logged Data	44
Setpoint Annunciators Mode	25	Real-time Clock.....	8, 44
Text Character - 2nd Digit [X7X]	25	Development Software	
Update Display at Selected Sample Rate.....	25	When to Use Macros	8
Code 2 - Channel 1 Measurement Task		Digital Input Pins	44
and Sampling Rate	38	Display Brightness Setting	20
Code 3 - Channel 1 Post Processing		Display Functions	25-37
and Serial Mode Functions	39	Bargraph Colors	26-27
Code 4 - Channel 2 Measurement Task		Bargraph Display.....	28
and Sampling Rate	40	Data Source	31
Code 5 - Channel 3 Functions	41	Display Format and Decimals	32

Display Rounding	32	Result Processing	43
Last Digit Text Character	33	Modbus	7, 22
Other Display Formats	4	Model Type Check	19
Setpoint Annunciator Mode	34	On Demand Functions	21
Update at Sample Rate	34	Ordering Information	64-66
Display Options		Panel Cutout	68
LED or LCD Displays	6	PID Control Settings	46, 50
Numeric or Alphanumeric Displays	6	Power Supply	5, 53
Push Button or Membrane Touch Pads	6	Prescaling	
Remote Display	6	Channel 1	38
Single or Multiple Displays	6	Channel 2	40
Faceplates		Print Mode	7, 39
Custom Faceplates	67	Programming Codes	17-18
Optional Caption Sheets	67	Programming Conventions	16
Custom Faceplate Design Template	67	Programming via PC	4, 10-11
Filtering		Registers	
<i>See Averaging Samples & Averaging Window</i>		Registers That Can Be Selected	52
Front Panel Controls	4, 14-15	Registers That Should Not Be Selected	52
Front Panel Programming Codes	17-18	Resetting and Incrementing Using Setpoints	52
Main Programming Mode	17	Relay Options	54
On Demand Modes	18	Serial Communication	5, 7-8
Setpoint Programming Mode	17	ASCII	7
View Modes	18	Configuration	39
Functional Diagram	53	DeviceNet	8
General Features	1	Ethernet	7
HMI Touch Panel Graphic Displays	7	Master Mode	7
Hysteresis and Deviation	45-48, 50	Modbus	7
Initial Setup Procedures	19-20	Pinouts	54
Code Blanking and Macro Check	19-20	Print Mode	7
Model and Software Code Version Check	19	RS-232 or RS-485	7
Input Signal Conditioning Modules	5, 57-63	Setpoint Programming Mode	45-51
Input Module Component Glossary	63	Data Logging	46
Input Module Index	57	Data Printing to PC	46
Input Modules	58-62	Data Printing to Serial Printer	46
Modular Position	55	Display Flashing	46
Ordering Information, Input Modules	64-65	Hysteresis or Deviation	46-48, 50
Input Signals & Sensors		Level 1 - Basic Mode - Prog. Procedures	49
4-20mA or Sensor Direct	6	PID Control Settings	46, 50
Sensor Linearization or Compensation	6	Real-time Clock Option	46
I/Os (Opto Isolated & Logic Ports)	5	Real Time Control Modes	47-48
Linearization		Relay Energize Functions	46
Channel 1 Temperature Sensors	38	Setpoint & Relay Control Settings	45, 50
Channel 1 User Loaded Tables	39	Setpoint Activation Source	46
Channel 2 Temperature Sensors		Setpoint Activation Values	45
and User Loaded Tables	40	Setpoint Latching	46
Channel 3 Temperature Sensors		Setpoint Reset & Trigger	46, 51
and User Loaded Tables	41	Setpoint Tracking	46
Channel 4 Temperature Sensors		Timer Modes	46, 51
and User Loaded Tables	42	Smart Input Modules	
Result of CH1 & CH2 User Loaded Tables	43	Setting Up	38
Table Settings	22, 43	Supplements	
Literature Overview		<i>See Literature Overview</i>	
Model Specific Data Sheets / User Manuals	3	Table of Contents	1
Other Tiger 320 Series Related Software	3	Timers	5, 46
Programming Code Sheet	3	Configuration	38, 41, 42
Supplements to Data Sheets / User Manuals	3	Delay Settings	51
Macros	4, 8, 11	Modes	47-48
Macro Check	19-20	Totalizers	
Manual Loader	25	Setting	21-22
Maths Function			
Cross Channel Maths	9, 43		

Front Panel Controls and Indicators

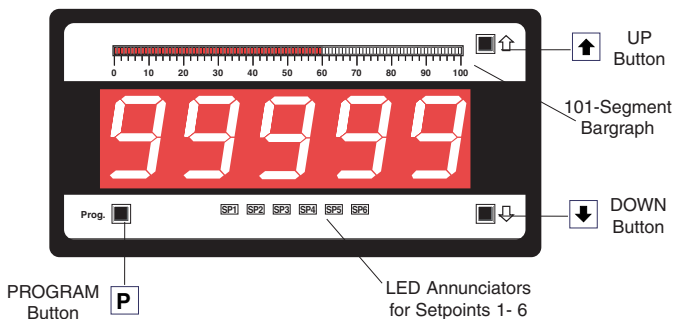

Display with Faceplate and Bezel

Optional Membrane Touch Pad Faceplate

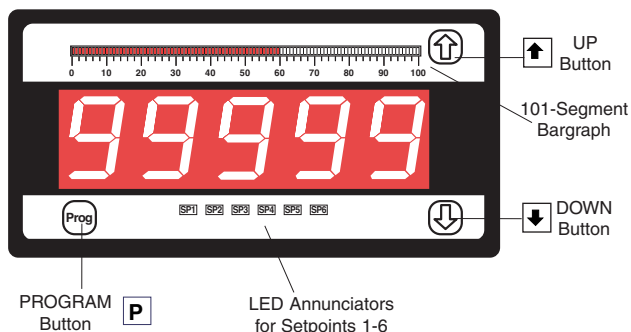

Display with Faceplate and Bezel

Program Button

While programming, pressing the **P** button saves the current programming settings and moves to the next programming step.

You can move through the programming codes using the program button. The codes you pass are not affected, unless you stop and make changes using the **↑** or **↓** buttons.

Pressing the **P** and **↑** button at the same time initiates the **main programming mode**. To save a new configuration setting and return to the operational display, press the **P** button once and then press the **P** and **↑** button at the same time.

Pressing the **P** and **↓** button at the same time initiates the **setpoint programming mode**. To save a new configuration setting and return to the operational display, press the **P** button once and then press the **P** and **↓** button at the same time.

See *Display with Faceplate and Bezel diagram*.

Up Button

When setting a displayed parameter during programming, press the **↑** button to increase the value of the displayed parameter.

When in the operational display, pressing the **↑** button initiates a viewing mode that allows you to view the readings on **channels 1 and 3, setpoints 1, 3, and 5, peak, and total 1**. Once into the viewing routine, pressing the **↑** button moves through each displayed parameter.

See *Display with Faceplate and Bezel diagram*.

Down Button

When setting a displayed parameter during programming, press the **↓** button to decrease the value of the displayed parameter.

When in the operational display, pressing the **↓** button initiates a viewing mode that allows you to view the readings on **channels 2 and 4, setpoints 2, 4, and 6, valley, and total 2**. Once into the viewing routine, pressing the **↓** button moves through each displayed parameter.

See *Display with Faceplate and Bezel diagram*.

Annunciator LEDs

The annunciator LEDs can be programmed to indicate the

alarm status.

Setpoint 1 can be configured to indicate the **rising** signal trend. Setpoint 2 can be configured to indicate the **falling** signal trend. They are labeled from left to right: SP1, SP2, SP3, SP4, SP5, SP6.

See *Display with Faceplate and Bezel diagram*.

Seven Segment LED Displays

The five, seven segment LED displays are used to display the meter input signal readings.

They also display the programming codes and settings during programming. The display is available in red, green, or super bright red LEDs.

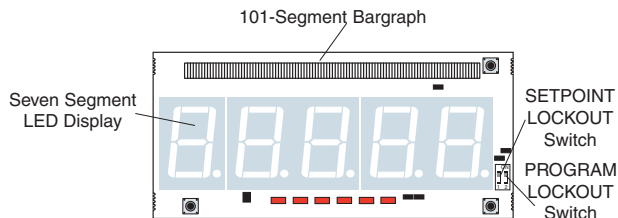

Display PCB without Faceplate and Bezel

LED Display

The meter has a 5-digit, 7-segment, 1" (25.4 mm) standard red, or optional green or superbright red LED numeric display. The LED displays are used to display the meter input signal readings. They also display the programming codes and settings during meter programming.

Bargraph Display

The bargraph display is a 101 segment red, green, or tri-color bargraph that can display the signal from any of four channels or the result of a processed input signal. The bargraph display is known as the secondary display during programming.

Display Text Editing with 7 Segment Alphanumeric Display Characters

Display text, such as setpoints, can be easily edited to suit your application, by connecting the meter to a PC running the free downloadable Configuration Utility program.

For Example:

Instead of [SP_1]

Instead of [SP_2]



OR



could be used for TANK LOW

could be used for BRAKE OFF

Scrolling Display Text Messaging

Scrolling display text messaging can be configured to run with a simple macro.

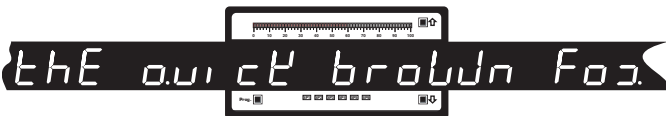

Display Text Characters

The following text characters are used with the 7-segment display.

7-SEGMENT DISPLAY CHARACTERS

1	2	3	4	5	6	7	8	9	0
A	b	c	d	E	F	G	H	I	J
ℓ	L	7	7	n	o	P	o	r	S
ℓ	u	U	U	U	3	4	2		

Program Lockout Switch

When the PROGRAM LOCKOUT switch is set to position 2, all programmable meter functions can be changed.

When set to the ON position, the PROGRAM LOCKOUT switch prevents any programming changes being made to the meter. If programming is attempted, the meter displays [LoC]. The ON position allows programming parameters to be viewed but not changed.

See Display PCB without Faceplate and Bezel diagram.

Setpoint Lockout Switch

When the SETPOINT LOCKOUT switch is set to position 1, the setpoints can be programmed. Once the setpoint values have been entered and the SETPOINT LOCKOUT switch set to the ON position, the setpoints can be viewed but not changed.

See Display PCB without Faceplate and Bezel diagram.

Error Message [Err]

Error messages usually occur during calibration procedures. The three most likely causes of an error message are:

- 1) The full scale and zero signals were too similar. Note, the high input (full scale) signal must be at least 1000 counts greater than the low input (zero) signal (positive and negative values are allowed).
- 2) The scaling requirement exceeded the capability of the meter (-19999 to +99999).
- 3) No input signal present, or incorrect connections.

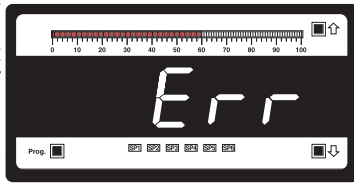

Display Showing Error Message

Rear Panel External Switched Inputs

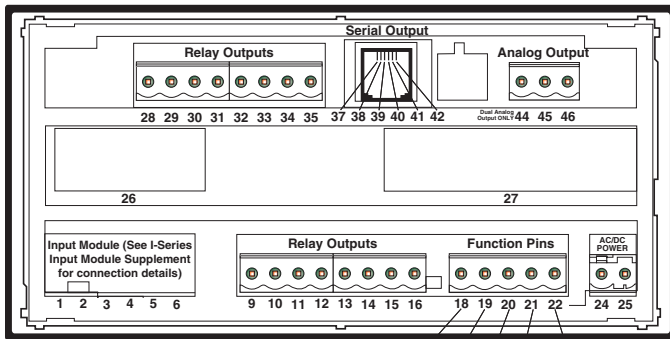

Rear Panel

Lock Pin

By configuring Coe 9 to [XX0], connecting the LOCK pin (pin 18 on the main PCB) to the COMMON pin (pin 21 on the main PCB), both the main and setpoint programming modes are locked out. All meter programming codes and setpoints can be viewed but not changed.

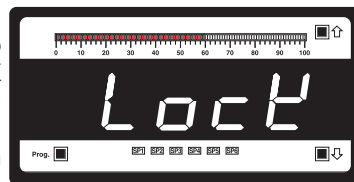

Display Showing [LoCK] Message

The main programming mode can be entered, but only the brightness setting adjusted. After adjusting the brightness setting, pressing the [P] button displays [LoCK].

The LOCK pin can also be configured in Code 9 to carry out the following functions (see *Meter Programming Codes* on Page 17):

- Reset channel 1 [XX1].
- Reset channel 2 [XX2].
- Reset channel 3 [XX3].
- Reset channel 4 [XX4].
- Reset tare [XX5].
- Reset total 1 [XX6].
- Unlatch (de-energize) all setpoints [XX7].

Hold Pin

Configure Code 9 to [X0X]. When the HOLD pin (pin 19) is connected to the COMMON pin (21) the displayed reading is frozen. However, A/D conversions and all control functions continue and as soon as pin 19 is disconnected from pin 21 by the switch, the updated reading is instantly displayed.

The HOLD pin can also be configured in Code 9 to carry out the following functions (see *Meter Programming Codes* on Page 17):

- Reset channel 1 [X1X].
- Reset total 1 and total 2 [X2X].
- Reset total 2 [X3X].
- Reset peak and valley [X4X].
- Reset tare [X5X].
- Set tare [X6X].
- Unlatch (de-energize) all setpoints [X7X].

Test Pin

Configure Code 9 to [0XX]. When the TEST pin (pin 20) is connected briefly to the COMMON pin (pin 21) all segments of the display and setpoint annunciators light up. Five eights and five decimal points (8.8.8.8.8.) are displayed for a short period. The micro-processor is also reset during this time, losing all RAM settings such as peak and valley, and any digital input pin settings set up in Code 9.

The TEST pin can also be configured in Code 9 to carry out the following (see *Meter Programming Codes* on Page 17):

- Reset counter channel 1 and total 2 at power-up [1XX].
- Reset counters, CH1, CH2, CH3, CH4, total 1, and total 2 at power-up [2XX].
- Reset total 1 and total 2 at power-up [3XX].

Capture Pin

When the CAPTURE pin (pin 22) is connected to the COMMON pin (pin 21), the CAPTURE pin can be programmed for setpoint/relay activation or macro control applications in the setpoint control settings mode of the setpoint programming mode [SPC_X] [X2X].

Common Pin

To activate the LOCK, HOLD, TEST and CAPTURE pins from the rear of the meter, the respective pins have to be connected to the COMMON pin (pin 21).

Front Panel Push Button Configuration and Setup for Programming Conventions

The meter uses a set of intuitive software codes to allow maximum user flexibility while maintaining an easy programming process. To configure the meter's programming codes, the meter uses the three right-hand side display digits. These are known as the first, second, and third digits and can be seen in the diagram opposite.

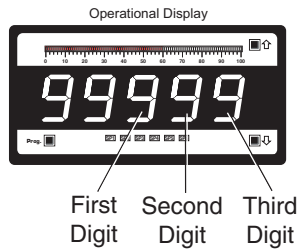

To explain software programming procedures, diagrams are used to visually describe the programming steps. The following conventions are used throughout the range of Tiger 320 Series document diagrams to represent the buttons and indicators on the meter, and the actions involved in programming the meter:

Symbol

Explanation



The display showing 99999 represents the **OPERATIONAL DISPLAY**. After the meter has been powered up, the display settles and indicates the calibrated input signal. This is known as the operational mode and is generally referred to as the operational display throughout the documentation.

All programming modes are entered from this level.



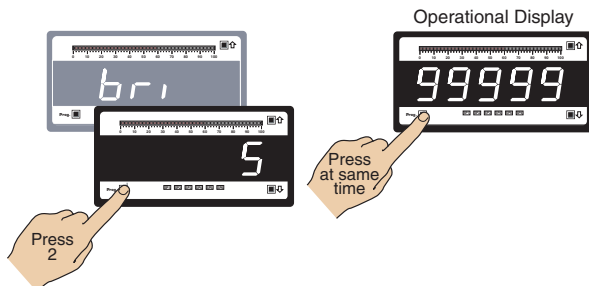

This symbol represents the **PROGRAM** button. In a procedure, pressing the program button is always indicated by a **left hand**. A number indicates how many times it must be pressed and released, or for how long it must be pressed before releasing.



This symbol represents the **UP** button. Shown in a diagram, pressing the UP button is always indicated by a **right hand**.



This symbol represents the **DOWN** button. Shown in a diagram, pressing the DOWN button is always indicated by a **right hand**.

Where two right hands are shown on the same diagram with the word OR between them, this indicates that both the  and  buttons can be used to adjust the display: UP for increase, DOWN for decrease.

[Span]
[10000]



Text or numbers shown between square brackets in a description or procedure indicate the programming code name of the function or the value displayed on the meter display.

Programming procedures are graphic based with little descriptive text.

Each procedure shows a number of meter panel displays running in procedural steps from the top to the bottom of the page.

If need be, the procedure may run into two columns with the left column running down the page and continuing at the top of the right-hand column. Each action performed by the user is shown as a numbered step.

Each procedural step shows the meter display as it looks before an action is performed. The hand or hands in the procedural step indicate the action to be performed and also how many times, or for how long, the button is to be pressed.

For example, the diagram below shows the meter in the operational display. With a left hand pressing the  button and a right hand pressing the  button, the user is entering the **main programming mode**. This is indicated by the next diagram displaying [bri] and [5]. This is the display brightness mode and is the first sub-menu of the main programming mode.

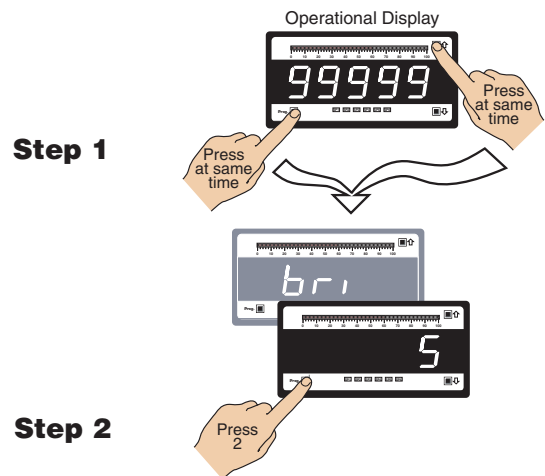

Where a left and right hand are shown on separate buttons on the same diagram, this indicates that the buttons must be pressed at the same time.

The exceptions to this rule are when carrying out the *Model and Software Code Version Check*, or the *Code Blanking and Macro Check*.

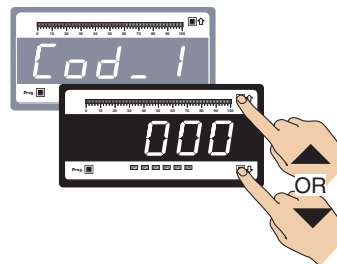

When two displays are shown together as black on grey, this indicates that the display is toggling (flashing) between the name of the function and the value or configuration setting.

Where a number is not definable, the default setting [000] is shown.



If an X appears in the description of a 3-digit programming code or in a configuration procedure, this means that any number displayed in that digit is not relevant to the function being explained, or more than one choice can be made.

Front Panel Programming Codes

The meter's programming codes are divided into two modes: the **main programming mode**, and the **setpoint programming mode** (See diagram below).

Each mode is accessible from the operational display.



Programming Tip

The easiest and fastest way to configure the Tiger 320 is to use a PC with the free downloadable configuration utility program. (see page 10)

Main Programming Mode

The main programming mode provides access to program all meter functions, except setpoints.

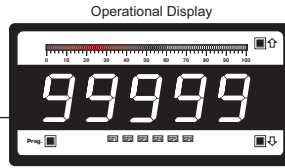

To enter or exit the Main Programming Mode, press **[P]** and **[↑]** at the same time

Main Programming Mode

- [bri]** Display Brightness
- [P]**
- [CAL]** Calibration Modes for Input and Output
- [P]**
- [Cod_1]** Code 1 – Display Configuration
- [P]**
- [Cod_2]** Code 2 – CH1 Measurement Task & Sampling Rate
- [P]**
- [Cod_3]** Code 3 – CH1 Post Processing & Serial Mode Functions
- [P]**
- [Cod_4]** Code 4 – CH2 Measurement Task & Sampling Rate
- [P]**
- [Cod_5]** Code 5 – CH3 Functions
- [P]**
- [Cod_6]** Code 6 – CH4 Functions
- [P]**
- [Cod_7]** Code 7 – Result Processing
- [P]**
- [Cod_8]** Code 8 – Data Logging & Print Mode
- [P]**
- [Cod_9]** Code 9 – Functions for Digital Input Pins
- [P]**
- [Cod10]** Code 10 – Bargraph Setup
- [P]**



Programming Tip

Save SP Settings & Exit
To save a new setpoint configuration setting and return to the operational display at any point, press the **[P]** button once. Then press the **[P]** and **[↓]** button at the same time to exit.



Programming Tip

Save Code Settings & Exit
To save a new main programming mode configuration setting and return to the operational display at any point, press the **[P]** button once. Then press the **[P]** and **[↑]** button at the same time to exit.

Setpoint Programming Mode

The setpoint programming mode provides access to program all setpoint and relay functions.

To enter or exit the Setpoint Programming Mode, press **[P]** and **[↓]** at the same time

Setpoint Programming Mode

Setpoint Activation Values Mode

Enter these menus to adjust SP activation values

- [SP_1]** Setpoint 1
- [P]**
- [SP_2]** Setpoint 2
- [P]**
- [SP_3]** Setpoint 3
- [P]**
- [SP_4]** Setpoint 4
- [P]**
- [SP_5]** Setpoint 5
- [P]**
- [SP_6]** Setpoint 6

Setpoint & Relay Control Settings Mode

Enter these menus to configure SP control values

- [SPC_1]** Setpoint 1
- [P]**
- [SPC_2]** Setpoint 2
- [P]**
- [SPC_3]** Setpoint 3
- [P]**
- [SPC_4]** Setpoint 4
- [P]**
- [SPC_5]** Setpoint 5
- [P]**
- [SPC_6]** Setpoint 6

The *Setpoint and Relay Control Settings* diagram on Pages 50 and 51 shows the three digit configuration settings that are applied individually to each setpoint.

See Page 49 for an example procedure to configure a setpoint for simple relay functions.

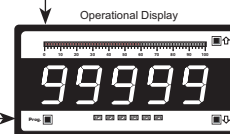

View Modes

While in the operational display, pressing the button allows you to view but not change the following parameters:

- Channel 1.
- Channel 3.
- Setpoint 1.
- Setpoint 3.
- Setpoint 5.
- Peak (of CH1).
- Total 1 (total of CH1).

While in the operational display, pressing the button allows you to view but not change the following parameters:

- Channel 2.
- Channel 4.
- Setpoint 2.
- Setpoint 4.
- Setpoint 6.
- Valley (of CH1).
- Total 2 (total of CH2).

Pressing both the and buttons at the same time while in either the peak, valley, total 1, or total 2 view modes resets the setting to the current displayed signal.

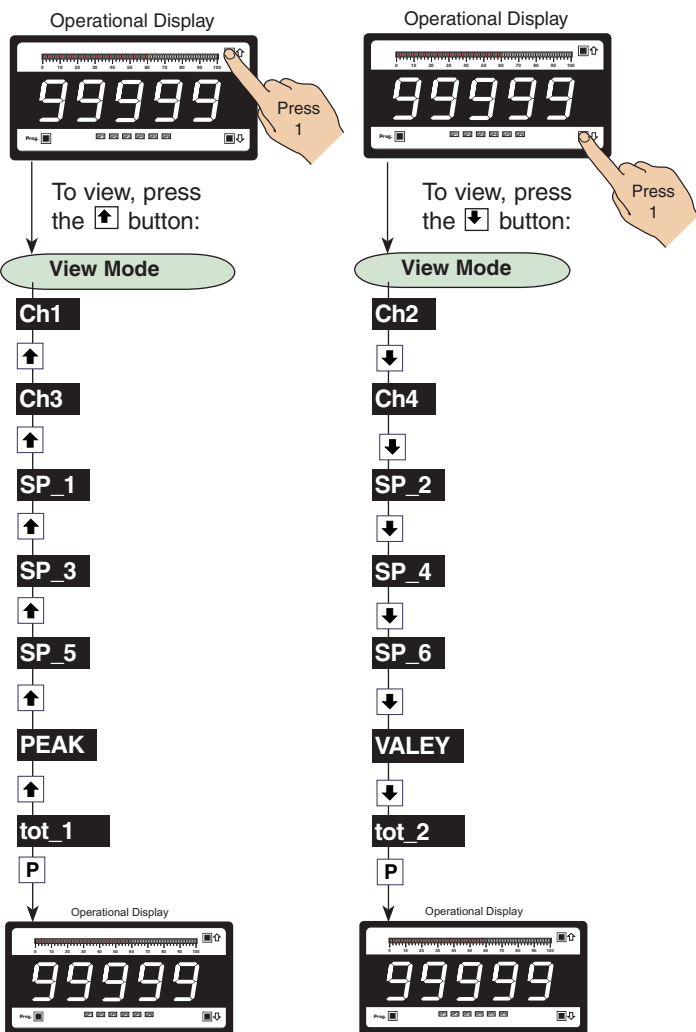

On Demand Modes

The meter can be programmed to activate the following functions on demand by pressing the button for 4 seconds:

- Tare.
- Single-point calibration.
- Two-point calibration.
- Primary input compensation.
- Manual loader (manual offset).
- Print.

The on demand function is selected in the calibration mode.

After configuring an on demand function in the **Calibration On Demand Mode**, press the button for 4 seconds to activate one of the following selected on demand modes.

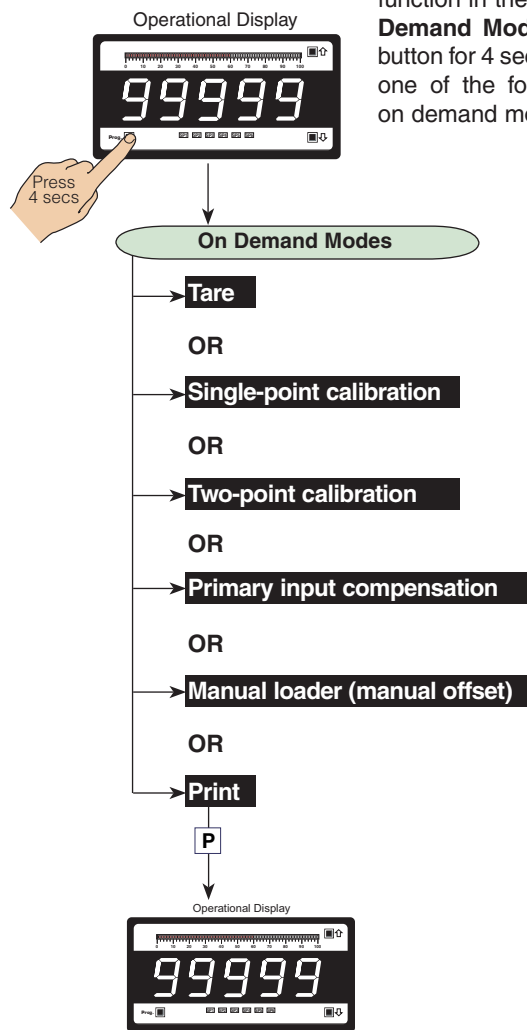

For a full breakdown of all programming codes, see the *Tiger 320 Series Programming Code Sheet (NZ101)*. See page 3 for more information.

Initial Setup Procedures

Before configuring the meter, carry out the following meter configuration checks:

- Model and software code version check.
- Code blanking and macro check.

After powering-up the meter, check the model and software code version number and note this in your user manual.

Model and Software Code Version Check

The meter model and software code version number can be checked at any time while in the operational display using the following procedure.

START HERE

MODEL & SOFTWARE CODE VERSION CHECK

Step 1

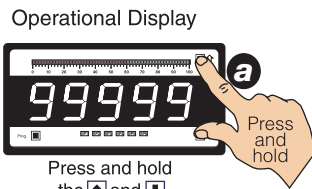

Press and hold the and buttons

Step 2

While holding both buttons, press the Prog. button then release all three buttons

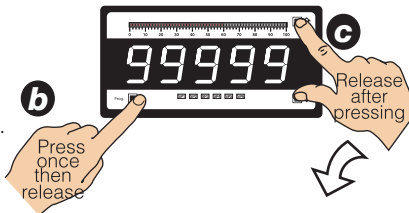

Example



Model Number



Software Version Number

Step 3

The above displays toggles three times before returning to the operational display

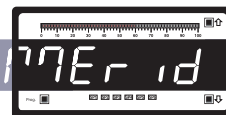
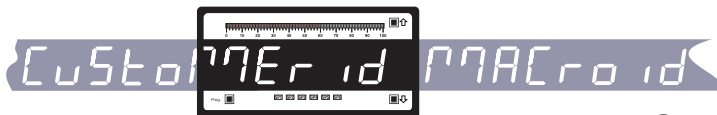

Operational Display

Model No:.....
 Software Version No:.....
 Customer ID:.....
 Macro ID:.....



Programming Tip

The *Model and Software Code Version* checking procedure can be performed at any time without interfering with other configuration settings.

Code Blanking and Macro Check

Tiger 320 Series meters have the ability to hide (blank out) all or some programming codes, making them tamper-proof. This can only be done using the Texmate Meter Configuration program.

With code blanking turned ON, all main and setpoint codes that have been blanked out during factory programming are hidden, preventing them from being reprogrammed. Any codes that have not been blanked out are still visible and can be reprogrammed.

Turning code blanking OFF means all meter programming codes are visible when you enter the programming modes and can be reprogrammed.

A macro is a set of commands that run automatically when the meter is powered up. Texmate has a growing library of macros to suit a wide range of standard customer applications.

Macros can be installed in the meter at the factory during initial programming or by the customer at some later date. Macros are written and compiled using the Texmate BASIC Compiler program, and loaded into the meter using either the BASIC Compiler program or the Texmate Meter Configuration program.

Turning the macro OFF means that the meter will not perform the automatic commands pre-programmed to run with the macro.

Unless requested to blank out all or some programming codes and/or run a macro, Texmate program the meter in the code blanking OFF and macro OFF (default) setting.

To turn the code blanking and macro settings from ON to OFF:

START HERE

CODE BLANKING & MACRO CHECK PROCEDURE

Step 1

Press and hold the and buttons

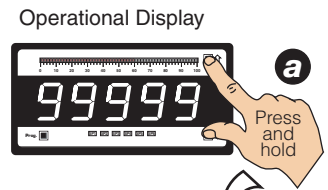

Step 2

While holding both buttons, press the Prog. button.

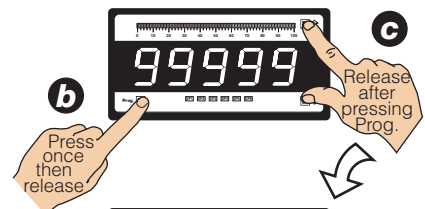

Step 3

Release the the and buttons and hold the Prog. button for approx. 1 sec then release

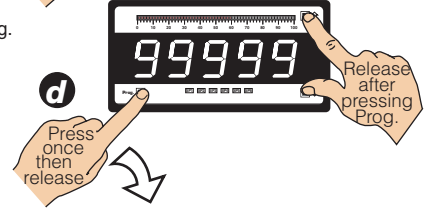

Example



Code Blanking

NOTE: Unless otherwise requested, the factory default setting is OFF

Step 4

Press the button to switch code blanking OFF

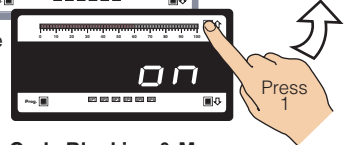

Code Blanking & Macro Check Procedure

continued on next page (Step 5)

continued from Step 4

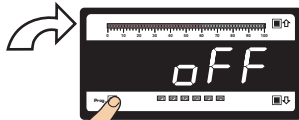

Step 5

Press the Prog. button.



Example



NOTE: Unless otherwise requested, the factory default setting is OFF

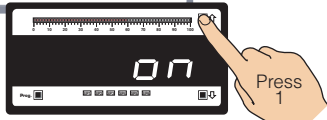

Step 6

Press the button to switch the macro OFF



Step 7

Press the Prog. button.



Operational Display



Programming Tip

Code Blanking and Macro ON/OFF settings revert to the meter's original configuration settings when the meter is powered off and on.

Display Configuration

Once you have read the User manual and related supplements, and installed and powered-up the meter, configure the display to suit its designated application.

Display Brightness Mode

The **display brightness mode** is accessed when entering the main programming mode. It allows you to adjust the brightness of the display LEDs and setpoint annunciators without interfering with other configuration settings. It is always available, even with the PROGRAM LOCK switch set to ON, or the external LOCK pin connected to the COMMON pin, locking out the programming modes.

The display brightness can be set between 0 and 7, with 0 being dull and 7 being bright. 5 is the default setting.

Example Procedure:

Configure the display brightness setting to 7 (bright).

START HERE
DISPLAY BRIGHTNESS MODE

Step 1

Enter Brightness Mode

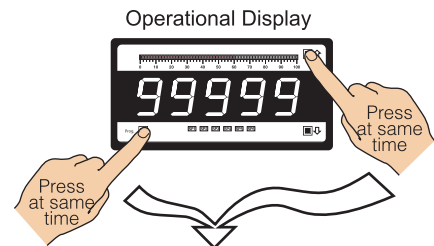

Step 2

Adjust brightness to 7

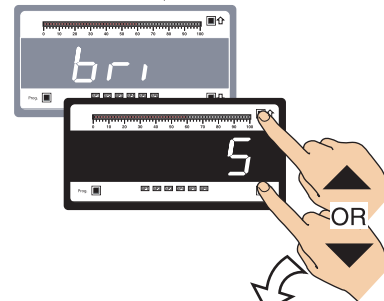

Example

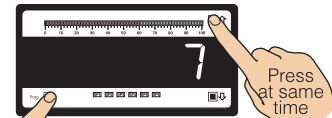

Step 3

Save brightness setting. Exit Brightness Mode. Return to Operational Display



Operational Display



Programming Tip

The *Display Brightness* setting procedure can be performed at any time without interfering with other configuration settings by entering the main programming mode.

[CAL] - Calibration Modes for Input and Output

The Tiger 320 Series meter has an extremely powerful set of input and output calibration modes. See diagram below.

ON DEMAND Functions

In this mode the meter can be programmed to activate one of the following on demand functions by pressing the **P** button while in the operational display:

- On Demand TARE.
- On Demand Single-point Calibration (requires single input source).
- On Demand Two-point Calibration (requires dual input source).
- On Demand Primary Input Compensation Mode.
- On Demand Manual Loader Mode.

Calibration Modes

The following calibration modes are available:

- Manual Calibration (requires NO input source).
- **Two-point Calibration (requires dual input source).**
This is the calibration mode generally used to calibrate the meter for most applications. An example procedure has been included.
- Calibrate Thermocouple (requires K type thermocouple input source).
- Calibrate RTD (requires RTD 385 input source).
- Calibrate Smart Input Module (not available on all input modules).
- Calibrate Analog Output (requires multimeter connected to pins 16 and 17).

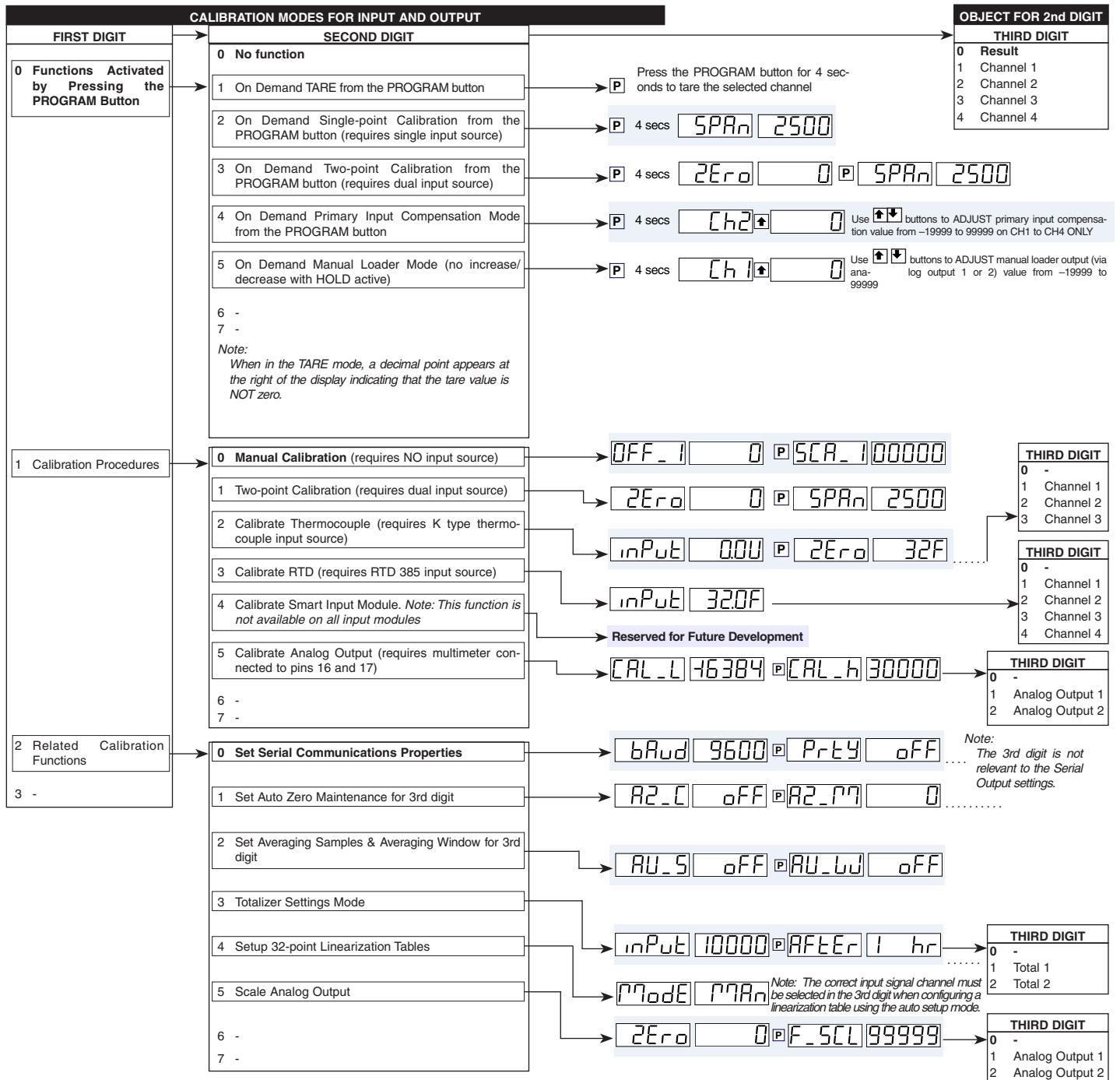

Related Calibration Functions

The following functions are also configured in the calibration mode. See *Advanced Calibration and On Demand Mode Supplement (NZ203)* for further calibration details. (See page 3 for more information).

Serial Communications Properties

Selecting [CAL][20X] enters the Serial Communications Properties Mode.

This mode allows you to configure the serial communications output module baud rate, parity, time delay, and address settings.

See the **calibration modes** diagram on Page 21 showing a breakdown of 1st, 2nd, and 3rd digits.

Also see the *Serial Communications Module Supplement (NZ202)* for further details on the serial communications module. (See page 3 for more information).

Set Auto Zero Maintenance

Selecting [CAL][21X] enters the Set Auto Zero Maintenance Mode.

This mode allows you to configure auto zero maintenance settings for weighing applications applied to the channel selected in the 3rd digit.

See the **calibration modes** diagram on Page 21 showing a breakdown of 1st, 2nd, and 3rd digits.

Set Averaging Samples & Averaging Window

Selecting [CAL][22X] enters the Set Averaging Samples and Averaging Windows Mode.

This mode allows you to configure the number of input signal samples to average over, and the size of the averaging window in display counts applied to the channel selected in the 3rd digit.

Selecting [CAL][22X] enters the Set Averaging Samples and Averaging Windows Mode. When in this mode, the [AV_S] menu allows you to select the number of input signal samples to average over. After setting the number of samples, moving to the [AV_W] menu allows you to configure the size of the averaging window in displayed counts.

The meter averages the input samples over the selected number of input samples (selected in the [AV_S] menu). This carries on in a continual process provided the input signal stays within the averaging window (set in the [AV_W] menu). If the sample moves out of the averaging window, the meter responds quickly to the change by displaying the non-averaged signal value. When the signal stabilizes, a new averaging window is established and averaging resumes.

You can program the number of samples you want to average the input signal over from 1 to 255 samples. The averaging window can be set to between 1 and 65535 counts.

See the **calibration modes** diagram on Page 21 showing a breakdown of 1st, 2nd, and 3rd digits.

See *Input Signal Sampling Showing Averaging Window* diagram opposite.

Example Procedure

The example procedure on Page 24 shows how to configure channel 1 (CH1) with an averaging sample rate of 10 counts and an averaging window of 1000 counts.

Totalizer Settings

Selecting [CAL][23X] enters the Totalizer Settings Mode.

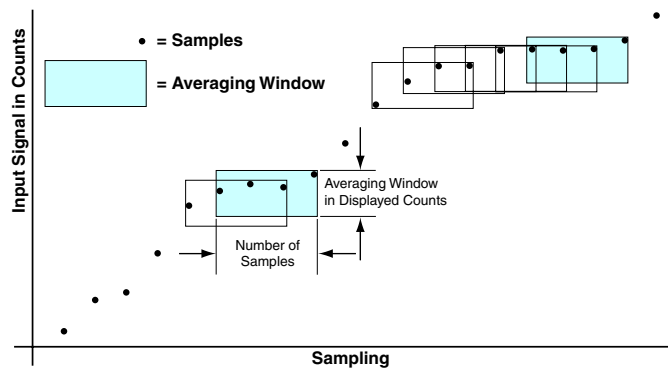

Input Signal Sampling Showing Averaging Window

This mode allows you to configure the settings for the totalizer selected in the 3rd digit. An input value of 10000 counts is applied to a selectable time period to produce the required total value.

The cutoff is a programmable limit below which the input is not totalized.

See the **calibration modes** diagram on Page 21 showing a breakdown of 1st, 2nd, and 3rd digits.

Also see the *Totalizing and Batching Supplement (NZ208)* for further details on K factor and totalizer cutoff parameters. (See page 3 for more information).

Setup 32-point Linearization Tables

Selecting [CAL][24X] enters the Setup 32-point Linearization Tables Mode.

This mode allows you to set up the linearization table or tables using the manual or auto setup modes. The table or tables can then be selected to linearize the signals on channels 1 to 4.

See **Linearization Table Notes** on Page 43 for a description of memory related issues with linearization.

See the **calibration modes** diagram on Page 21 showing a breakdown of 1st, 2nd, and 3rd digits.

Also see the *Linearizing Supplement (NZ207)* for further details on linearization table setup and use. (See page 3 for more information).

Scale Analog Output

Selecting [CAL][25X] enters the Scale Analog Output Mode.

This mode allows you to calibrate and scale the analog output signal. Before calibrating the analog output in the calibration mode, the data source for the analog output must be configured in Code 1.

See the **calibration modes** diagram on Page 21 showing a breakdown of 1st, 2nd, and 3rd digits.

Also see the *Analog Output Module Supplement (NZ200)* for further details on the analog output module. (See page 3 for more information).

Also see *Configure Data Source Procedure* on Page 31 for an example of setting the analog output data source.

Calibration Mode Procedures Supplement

The *Advanced Calibration and On Demand Mode Procedures Supplement (NZ203)* describes in detail all Tiger 320 Series meter related calibration procedures configured in the calibration mode.

Two-point Calibration

Two-point calibration is the most commonly used method of calibrating Tiger 320 Series meters when a low and high input source is available.

Example Calibration Procedure

Calibrate channel 1 (CH1) using the two-point calibration method. The calibration mode display is set to [111].

The low input source is applied to the meter when setting the zero value.



The high input source is applied to the meter when setting the span value.



START HERE

TWO-POINT CALIBRATION

Step 1

Enter Brightness Mode

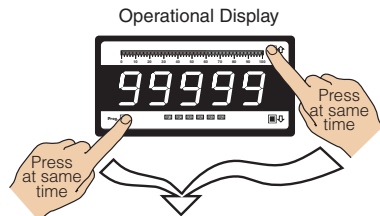

Step 2

Pass Brightness Mode and enter Calibration Mode

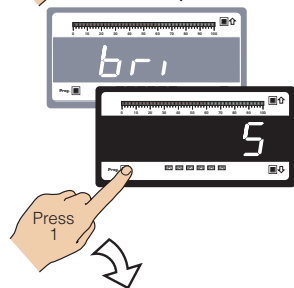

Step 3

Set Calibration Mode to [111]:
 1st Digit = 1 Selects calibration procedures
 2nd Digit = 1 Selects 2-point calibration
 3rd Digit = 1 Selects CH1 for calibration

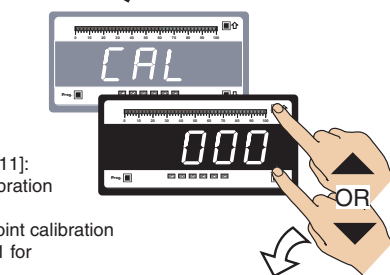

Step 4

Enter the Zero Mode

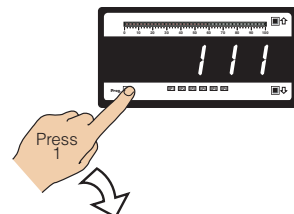

Step 5

5.1. Adjust display to desired reading for zero input
 5.2. Apply the LOW input signal

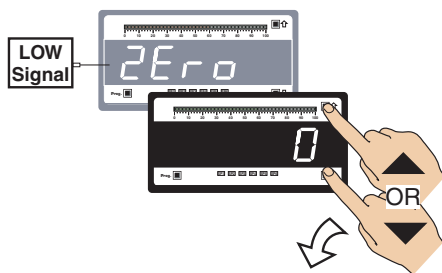

Step 6

Set reading for zero load into meter and enter Span Mode

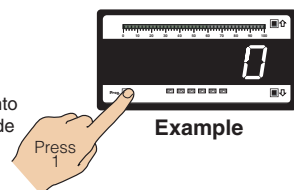

From Step 6

Step 7

7.1. Adjust display to desired reading for span input
 7.2. Apply the HIGH input signal

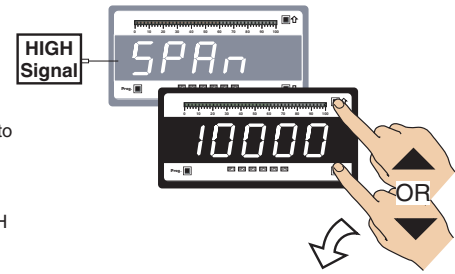

Step 8

Save zero and span settings and re-enter Calibration Mode

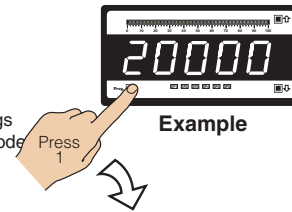

Step 9

Select the No Function Calibration Mode [000]

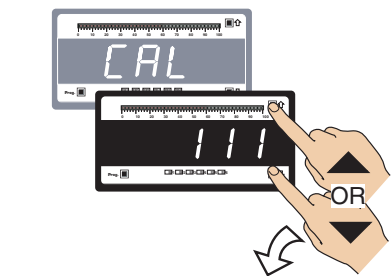

Step 10

Save Calibration Mode [000] setting and enter Code 1

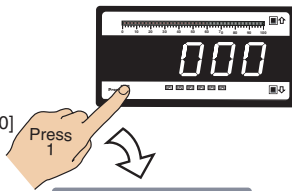

Step 11

Exit Code1. Return to Operational Display

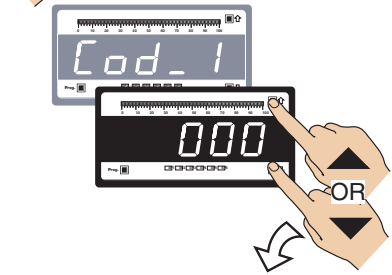

To Step 7



Input Signal Filtering and Averaging

Input signal filtering and averaging is configured in the calibration mode. Programmable averaging allows you to program the number of samples you want to average the input signal over (from 1 to 255 samples).

A programmable averaging window provides a quick response time to large input signal changes. The averaging window can be set to between 1 and 65535 counts.

START HERE

INPUT SIGNAL FILTERING & AVERAGING

Step 1

Enter Brightness Mode

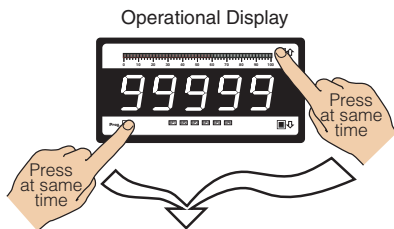

Step 2

Pass Brightness Mode and enter Calibration Mode

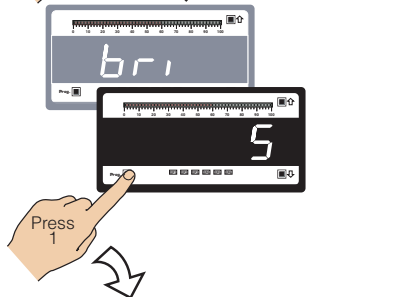

Step 3

Set Calibration Mode to [221]:
 1st Digit = 2 Selects related calibration functions
 2nd Digit = 2 Selects averaging samples for 3rd digit
 3rd Digit = 1 Selects channel 1 for 2nd digit

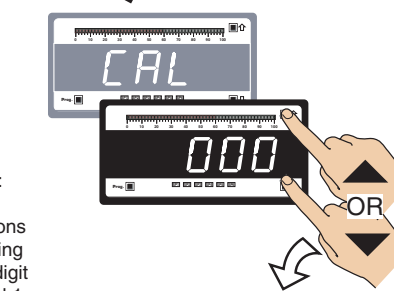

Step 4

Enter the Averaging Sampling Rate Mode

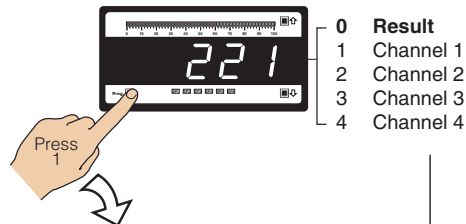

Step 5

Select averaging sampling rate from 1 to 255 samples

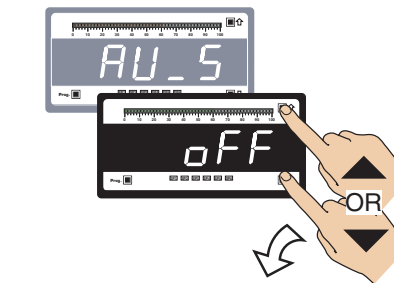

Step 6

Save averaging sampling rate setting and enter the Averaging Window mode

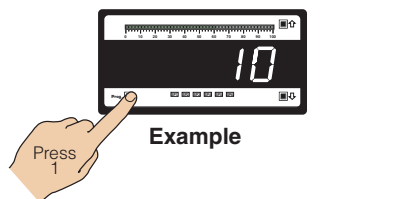

Example Procedure:

Select an averaging sampling rate of 10 samples and an averaging window of 1000 counts for Channel 1 by setting [CAL] to [221].

See Advanced Calibration & On Demand Mode Supplement (NZ203) for further calibration procedures. (See page 3 for more information).

Step 7

Select averaging window between 1 and 65535 counts

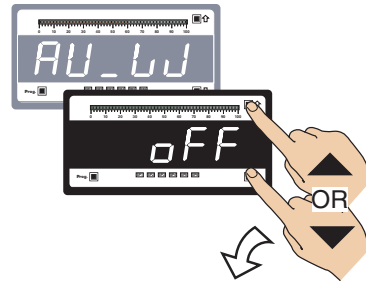

Step 8

Save averaging window settings

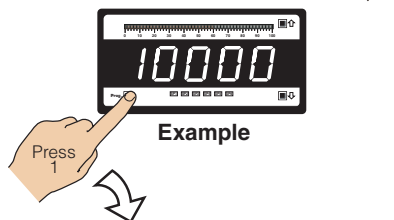

Step 9

Select [000] to leave the Calibration Mode

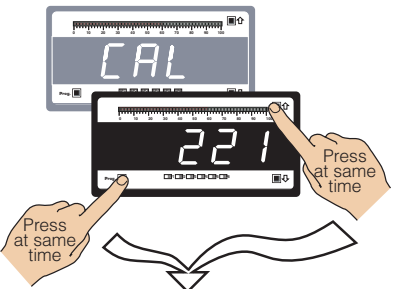

Step 10

Save settings

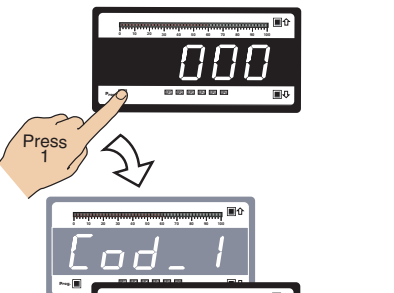

Step 11

Exit Code 1. Return to Operational Display

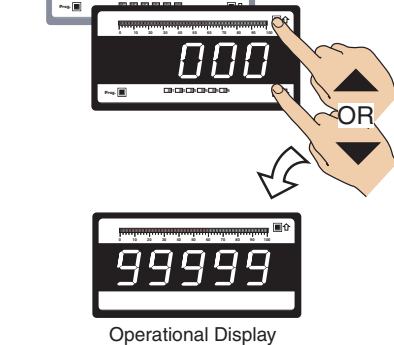

CODE 1] - Display Configuration

All digital display configuration modes, except the display brightness mode, are configured in Code 1.

All bargraph display configuration modes are configured in Code 10 (See diagram below).

See Code 1 diagram on Page 32 for a breakdown of 1st, 2nd, and 3rd digit settings.

See Code 10 diagram on Page 30 for a breakdown of 1st, 2nd, and 3rd digit settings.

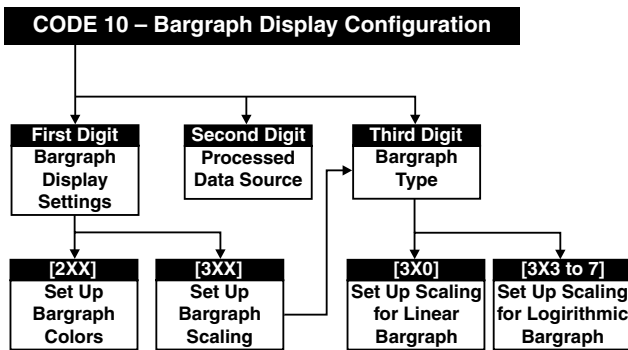
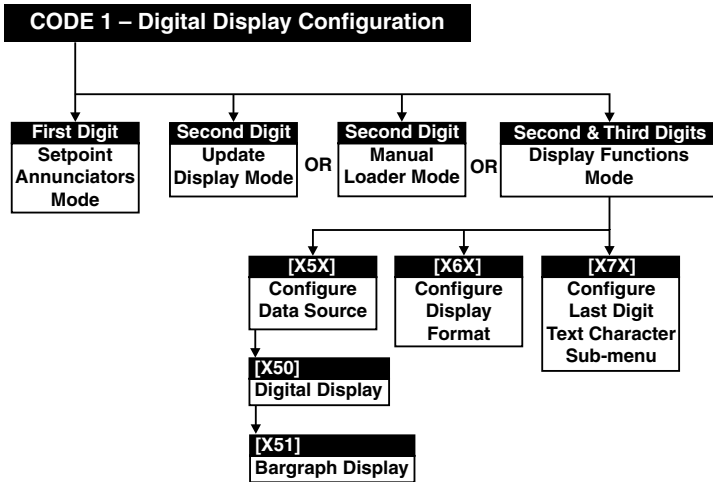

CODE 1 – Digital Display Configuration

Setpoint Annunciators Mode

The setpoint annunciators mode is configured by changing the first digit in Code 1. The setpoint annunciators can be configured to operate as follows:

- On when the setpoint activates.
- All annunciators are permanently on and each one only goes off when its setpoint activates.
- All annunciators are always off (See Note 1 on Code 1 diagram on Page 29).
- Setpoint 1 annunciator comes **on** indicating a **rising signal**. Setpoint 2 annunciator comes **on** indicating a **falling signal**.

Example Procedure. The example procedure on Page 34 shows how to select the setpoint annunciators to come ON when the setpoints are OFF (not active).

Update Display at Selected Sample Rate

The meter's default display update rate is 0.5 seconds and is

set in the second digit of Code 1 as [X0X].

The display can be configured to update at the input signal sample rate selected in Code 2.

Example Procedure. The example procedure on Page 34 shows how to configure the display to update at 50 samples per second by setting Code 1 to [X2X].

For these settings to take effect, the analog sample rate must be set at [2XX] in Code 2. See Code 2 – Channel 1 Measurement Task and Sampling Rate on Page 38 for an example.

Manual Loader Mode

The meter can be configured to function exclusively as a manual loader by setting Code 1 to [X1X].

See Analog Output Module Supplement (NZ200) for full details on manual loader mode functions.

Display Functions Mode

The display functions mode is configured by changing the 2nd and 3rd digits in Code 1:

- Selecting [X5X] enters the **Data Source** sub-menu.
- Selecting [X6X] enters the **Display Format** sub-menu.
- Selecting [X7X] enters the **Last Digit Text Character** sub-menu.

Data Source – 2nd Digit [X5X]

The **digital** display is the **primary** display. The **bargraph** display is the **secondary** display.

To select the data source for the **primary** display select 5 in the 2nd digit and 0 in the 3rd digit [X50].

To select the data source for the **secondary** display select 5 in the 2nd digit and 1 in the 3rd digit [X51].

Selecting 5 in the 2nd digit enters a sub-menu and allows the data from one of a number of meter registers to be selected as the data source for the displays or functions selected in the third digit.

Example Procedure. The example procedure on Page 31 shows how to select the data source for the **primary** display. The three digits are set to [X50]. The same example can be used for selecting the data source for the **secondary** display (bargraph). The three digits are set to [X51].

The 2nd digit in Code 1 can also be used to select the data source for the remaining functions in the 3rd digit:

- [X53] = Peak and Valley.
- [X54] = Analog Output 1.
- [X55] = Analog Output 2.
- [X56] = Totalizer 1.
- [X57] = Totalizer 2.

Display Format – 2nd Digit [X6X]

Selecting 6 in the 2nd digit enters the Display Format sub-menu where the following display format settings can all be configured:

- Last digit rounding.
- Display units (Decimal, octal, or optional 12 or 24-hour clock).
- Decimal point placement.

Example Procedure. The example procedure on Page 32 shows how to configure the three display format modes for the 3rd digit selection.

Code 1 - Display Configuration continued

Text Character – 2nd Digit [X7X]

Selecting **7** in the 2nd digit allows you to select one of 54 characters and apply it to the last digit when the meter is in the operational display.

For example, if the meter was measuring a temperature, the display could be configured to display the reading with a C or an F in the last digit for °C or °F.

Example Procedure. The example procedure on Page 33 shows how to configure the last digit text character as “C” for centigrade (°C) for the 3rd digit selection.

Note:

After setting any or all the above three modes [X5X], [X6X], [X7X], the Code 1 display must be set back to [X0X] to leave Code 1 and carry on programming.

CODE 10 – Bargraph Display Configuration

Set Up Bargraph Colors

This mode is where the colors of the bargraph relative to the setpoints are set. Tri-color bargraphs use the following three colors:

- Green.
- Orange.
- Red.

The bargraph colors are not applied to specific setpoints. They are applied to whichever setpoint is configured at the lowest setting, and then to each next highest setpoint in turn.

Only one color is displayed on the bargraph at any time. As the signal changes, the color selected for the most recently activated setpoint displays.

Only setpoints with the same source data as the bargraph are displayed.

If all six setpoints are used the colors are set as follows:

- **Color 1.** Color BELOW lowest setpoint.
This is the bargraph color before it reaches a setpoint.
- **Color 2.** Color ABOVE lowest setpoint and BELOW the next highest.
- **Color 3.** Color ABOVE the 2nd lowest setpoint and BELOW the next highest.
- **Color 4.** Color ABOVE the 3rd lowest setpoint and BELOW the next highest.
- **Color 5.** Color ABOVE the 4th lowest setpoint and BELOW the next highest.
- **Color 6.** Color ABOVE the 5th lowest setpoint and BELOW the next highest.
- **Color 7.** Color ABOVE the highest setpoint.

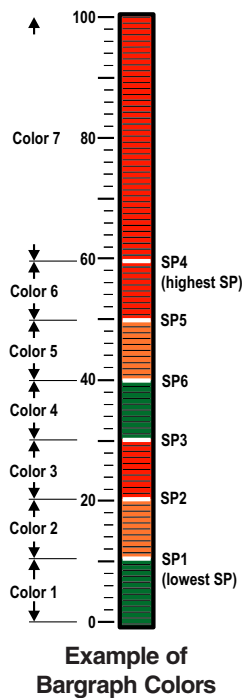

Any one of the colors (green, orange, red, or OFF – meaning no color) can be applied to each color setting (See Example: Bargraph Colors diagram above). Selecting **2** in the 1st digit enters the Set Up Bargraph Colors mode. Selections for the 2nd and 3rd digits are not relevant at this point.

Example Procedure. The example procedure on Page 35 shows how to configure the bargraph colors.

Set Up Bargraph Scaling

This mode is where the span range of the bargraph is scaled. The span range of the bargraph can be set between –19999 to 99999 counts. There are three methods of scaling the bargraph:

- Linear.
- Via Linearization Table 1.
- Logarithmic.

Selecting **3** in the 1st digit enters the Set Up Bargraph Scaling mode.

Linear Bargraph Scaling

The most common method of scaling the bargraph is through the Linear Bargraph Scaling sub-menu. In this menu the bar low, bar high, and bar nominal settings are set.

Bar Low [bAr_L] is the setting in counts required at the bottom of the bargraph.

Bar High [bAr_h] is the setting in counts required at the top of the bargraph.

Bar Nominal sets the point on the bargraph at which the bar begins to light up. This can be any position between and including the bar low and bar high settings.

If bar nominal is set to the **bar low** setting, the bargraph behaves like a typical bargraph making the segments light up from the **bottom** of the bar and grow towards the top.

If bar nominal is set to the **bar high** setting, this makes all segments from the displayed signal to the **top** of the bar light up. As the signal increases, the number of lit segments between the signal and the bar high setting becomes steadily less. When the signal reaches the bar high setting no segments are lit.

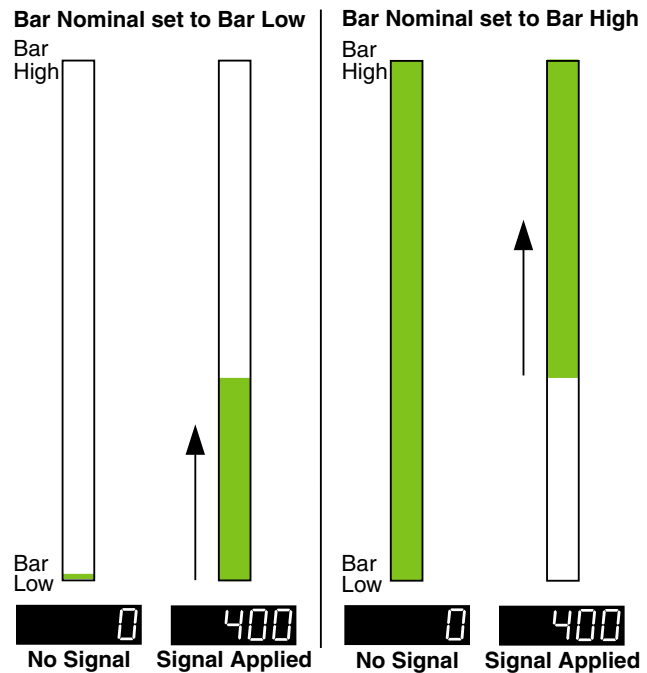

Bargraph Nominal Set Low or High

Setting bar nominal to the midpoint between bar low and bar high makes the bargraph behave like a typical center zero bargraph. This means the bargraph lights up at the center of the bar and moves either up or down the bar depending on the displayed signal.

[Code 1] - Display Configuration continued

For example, if the meter's full scale range is 20,000 counts, the midpoint is 10,000 counts. If a signal of 10,000 counts is applied, only one segment at the 10,000 count mark lights up. If a signal of 17,000 counts is applied, the segments between the center segment (10,000 counts) and the 17,000 count mark light up.

If a signal of 5000 counts is applied, the segments between the center segment (10,000 counts) and the 5000 count mark light up.

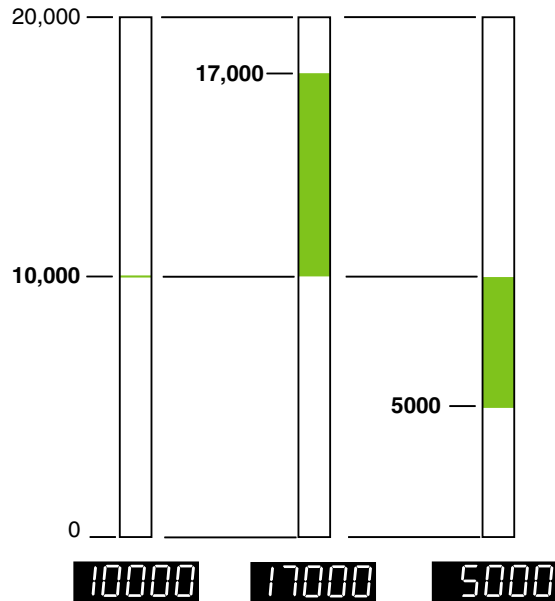

Typical Center Zero Bargraph

An added feature of this bargraph is that it can also be non-symmetrical. This means that the bar nominal setting does not need to be set at the mid-point between bar low and bar high. For example, if the bargraph is configured to display -200 to 800 °C, bar low is set to -200 counts and bar high is set to 800 counts. Bar nominal is set to 0 counts. If a signal of -50 °C is applied, the bar lights from 0 down to -50 . If a signal of 600 °C is applied, the bar lights from 0 up to 600 .

Example Procedure. The example procedure on Page 36 shows how to scale the bargraph using linear scaling.

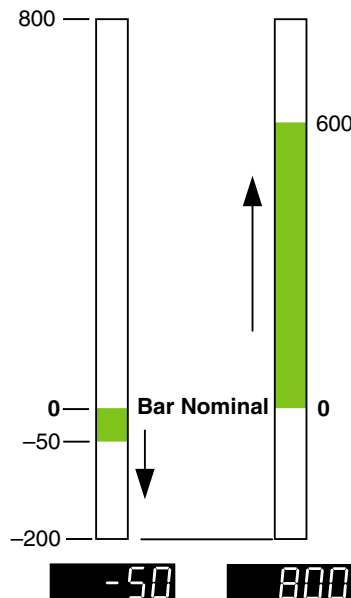

Non-symmetrical Zero Bargraph

Bargraph Scaling using Linearization Table 1

When set in this mode, the register selected to be displayed on the bargraph display (Code 1 set to [XX1]) is first processed through a 32-point flexible linearization table (Table 1) before being displayed.

This can be used, for example, if channel 1 is the required digital display while the bargraph display is the square root of channel 1.

See *Linearization Supplement* for full details to set up linearization Table 1.

Selecting **3** in the 1st digit and **1** in the 3rd digit selects Bargraph scaling via Linearization Table 1.

Example Procedure. To scale the bargraph using Linearization Table 1, follow the *Scale Bargraph using Linear Scaling Procedure* on Page 36. Ensure the secondary (bargraph) display has been set up in Code 1 and Linearization Table 1 has been formatted and selected for the required application.

Logarithmic Bargraph Scaling

Logarithmic scales are used in a wide variety of measurements. Probably the most well known logarithmic scale is the Richter scale for measuring earthquakes. Other log scales used include sound level (dB), radio frequency signals, power levels (dBm), and numerous radiation signals.

In all logarithmic scales a reference level is required that is the level at 0 dB. For example, in an RF measurement 0 dBm is at a reference of 1 mW.

The scale is calculated from:

$$10 \log_{10} \frac{\text{counts (input)}}{\text{reference}}$$

If the meter is scaled so that:

$$1 \text{ mW} = 100 \text{ counts and } 1 \text{ W} = 100,000 \text{ counts}$$

Then the reference for 0 dBm would be set to 100 counts:

$$10 \log_{10} \frac{(\text{input})}{100} = 0 \text{ dBm}$$

Decade (Counts)	dBm
1	-20
10	-10
100	0
1000	10
10,000	20
100,000	30
1,000,000	40

Now every 10 dBm represents a decade, the bargraph can be scaled to a different amount of bars per decade (as set in the 3rd digit).

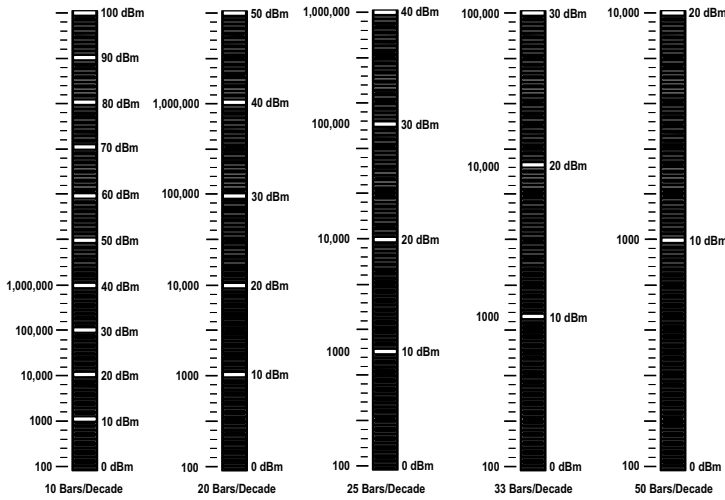

Example of Bars per Decade

Reference. This is the number of counts displayed for a 0 dB reference. Range: 1 to 99999 counts.

Bar Nominal. See Bar Nominal description under heading: *Linear Bargraph Scaling.*

Selecting **3** in the 1st digit and **3, 4, 5, 6, or 7** in the 3rd digit enters the Set Up Scaling for Logarithmic Bargraph sub-menu:

- Selecting **3** in the 3rd digit sets the log to 10 Bar/Decade.
- Selecting **4** in the 3rd digit sets the log to 20 Bar/Decade.
- Selecting **5** in the 3rd digit sets the log to 25 Bar/Decade.
- Selecting **6** in the 3rd digit sets the log to 33 Bar/Decade.
- Selecting **7** in the 3rd digit sets the log to 50 Bar/Decade.

Example Procedure. The example procedure on Page 37 shows how to scale the bargraph using example logarithmic settings.

Bargraph Display Format

After the bargraph colors have been set and the bargraph scaled, the display format can be set. This is normally the final setting. The 2nd digit selects the format of the bargraph display. There are four display format settings available:

- **Setpoints on Bar.** Selecting [X0X] means that the setpoints are displayed on the bar as flashing segments in the current display color. When the display color changes, the setpoint segments change to that color. When the bargraph lights up on or beyond a setpoint, the setpoint segment goes out.

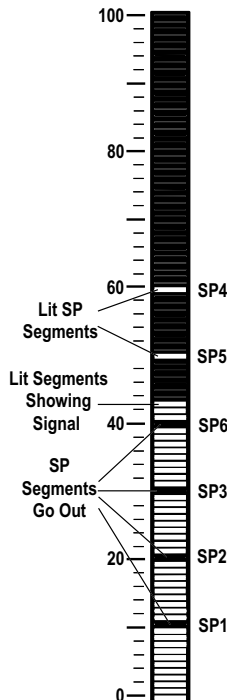

Example of Setpoints on Bargraph

- **Peak and Valley on Bar.** Selecting [X1X] means that peak and valley are displayed as flashing segments and are updated as they change. The setpoints are not displayed.
 - **Min/Max with Setpoints.** Selecting [X4X] means that the segments of the bar remain lit over the minimum and maximum signal variations. The setpoints are displayed as flashing segments.
- This is a useful mode for seeing process variations at a glance.

Note:
When moving from another display format to the **Min/Max with Setpoints** mode, the peak and valley settings must be set to the current settings by entering the Peak View mode or Valley View mode and pressing the UP and DOWN buttons at the same time.

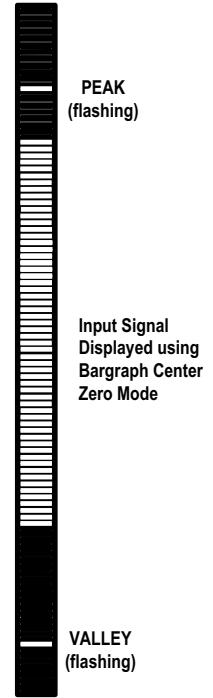

Example: Peak and Valley on Bargraph

When moving from **Min/Max with Setpoints** mode to another display format, the bar nominal [bAr_n] setting must be reset to its original settings in Code 10 [3XX].

- **Bar Only.** Selecting [X7X] means that only the bargraph display signal is displayed on the bar. Setpoints and peak and valley are not displayed.

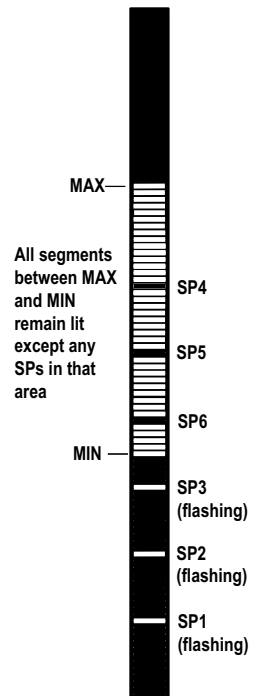

Example: MIN and MAX on Bargraph

FIRST DIGIT	SECOND DIGIT	THIRD DIGIT
CODE 1 – DISPLAY CONFIGURATION		
FRONT PANEL ANNUNCIATORS	DISPLAY FUNCTIONS	SELECT DATA SOURCE FOR
0 ON when Setpoints are ON (relay energized) 1 ON when Setpoints are OFF (relay de-energized) 2 Always OFF. See Note 1 3 LED SP1 ON indicates RISING signal trend. LED SP2 ON indicates FALLING signal trend.	0 Normal Display Mode (i.e. operational display shows selected register) updates every 0.5 seconds 1 Manual Loader Mode (Direct Display). See Note* 2 Update at sample rate selected in Code 2 3 - 4 - 5 Select data source as per 3rd digit. See Note 4 6 Select display format as per 3rd digit. See Note 4 7 Select text character as per 3rd digit. See Note 4	0 Primary Display 1 Second Display. See Note 2 2 Third Display. See Note 2 3 Peak/Valley 4 Analog Output 1 5 Analog Output 2 6 Totalizer 1 7 Totalizer 2
		SELECT DISPLAY FORMAT FOR
		0 Result 1 Channel 1 2 Channel 2 3 Channel 3 4 Channel 4 5 Default Display 6 Total 1 7 Total 2
		SELECT TEXT CHARACTER FOR
		0 Result 1 Channel 1 2 Channel 2 3 Channel 3 4 Channel 4 5 Default Display 6 Total 1 7 Total 2

Select Data Source
See diagram below

Select Display Format
See diagram below

Select Last Digit Text Character
See diagram below

Note:*
For the Manual Loader Mode (Direct Display) to work, with Code 1 set to [X54] the data source for the analog output (1 or 2) must be set to [diSP].
Operating range upper and lower limits can be set for the manual loader mode.
The setpoint activation values for setpoint 5 becomes the upper limit and setpoint 6 becomes the lower limit.
When either the direct display or on demand manual loader mode is programmed into the meter, the values for setpoint 5 and setpoint 6 are activated as upper and lower limits.
See Analog Output Supplement for further details.

Note 1:
LED annunciators are always off, except when the meter is in single channel VOLTAGE or CURRENT mode and Code 3 = [X6X], or Code 7 = [X6X] in which case the LEDs indicate which 32-point table has been selected from the rear pins (SP1 = Table 1, SP2 = Table 2, SP3 = Table 3, SP4 = Table 4).

Select Data Source



[100] [10] [1] [diSP] [rESLt] [Ch1]
 [200] [Ch2]
 [244] [Ch3]
 [tArE] [VALeY] [PEAK] [tot_2] [tot_1] [Ch4]

Use the [up/down] buttons to cycle through the Registers Menu and Registers (1 to 244) to select data source for displays, peak and valley, totalizers and analog output (also see page 52).

Display Format Mode

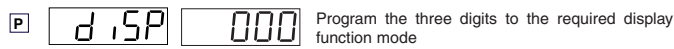

FIRST DIGIT	SECOND DIGIT	THIRD DIGIT
LAST DIGIT ROUNDING	DISPLAY UNITS	DECIMAL POINT PLACEMENT
0 No rounding 1 Rounding by 2's 2 Rounding by 5's 3 Rounding by 10's	0 Decimal 1 24-hour clock mode Hours: Minutes: Seconds (6-digit version only) 2 12-hour clock mode (12:30 am is displayed as 12:30A. 12:30 pm is displayed as 12:30P) 3 24-hour clock mode Days: Hours:Minutes (6-digit version only) 4 - 5 - 6 - 7 Octal	0 No decimal point 1 -XX.XX.XX 2 -X.XXXXX 3 X.XXXXX 4 X.XXX 5 X.XX 6 X.X 7 Decimal Point set from the rear (X.XXXXX to XXXXX) See Note 3. Also See Note 4.

Note:
Selecting 1, 2, or 3 in the 2nd digit of this mode configures the display of the selected channel as a clock.

Note 2:
These options are only for use with meters that have more than one display. With bargraph meters the PRIMARY display is the digital display, and the SECONDARY display is the bargraph display.

Note 3:
These functions are only available on selected input modules.

Note 4:
If Code 1's display modes have been entered (second digit set to 5, 6, or 7), the display will cycle between Code 1 and the display functions mode each time the PROGRAM button is pressed. To leave the cycle, the Code 1 digits must be reset to any relevant function between [X00] to [X20]. This takes you into Code 2.

Select Last Digit Text Character

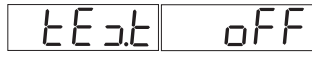

Use the [up] button to cycle through the menu, and the [down] button to cycle back.

Press the Up or Down button 4 times as the next 4 characters are blank.

Note:
Data source for the bargraph is set up in Code 1 [X51].

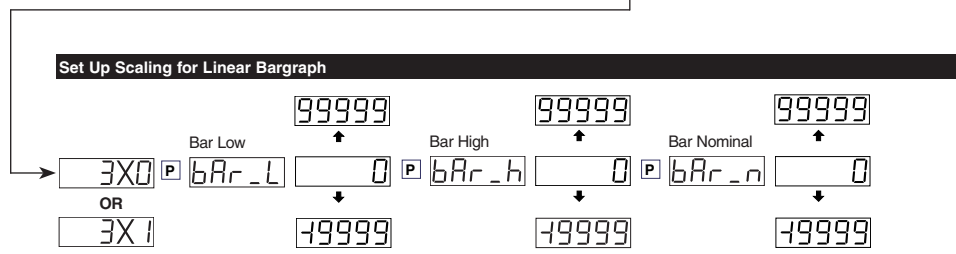
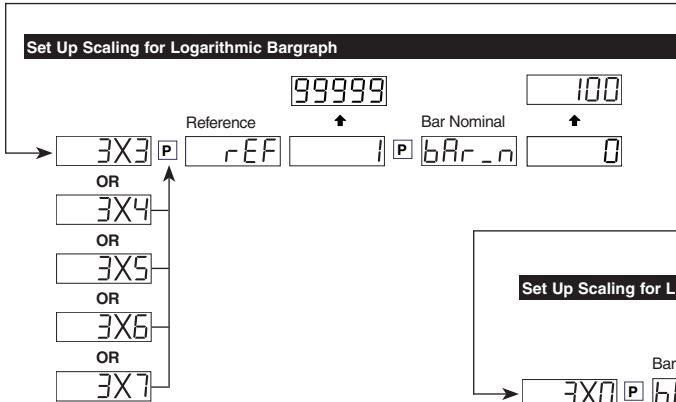
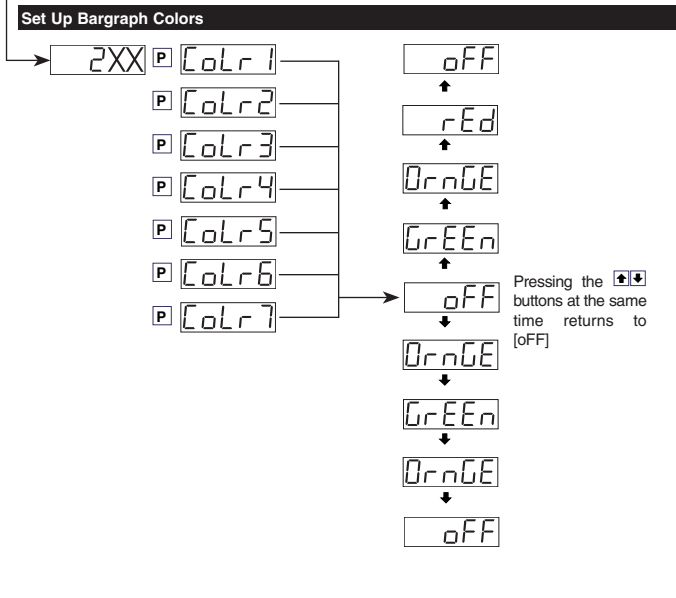
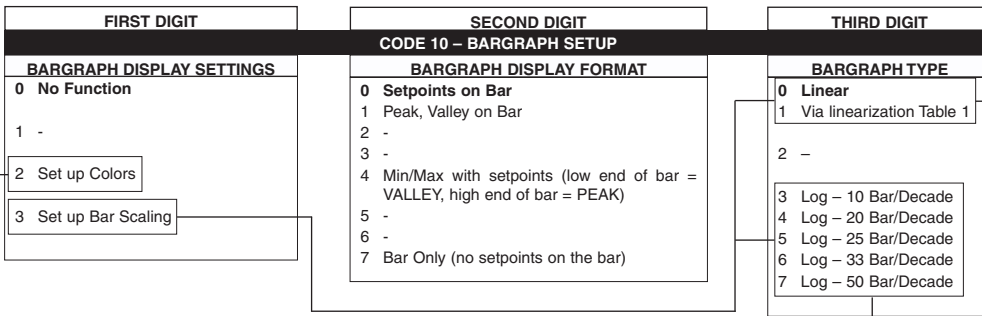

Configure Data Source Procedure

The following example procedure describes how to select the source of the data to be displayed for the third digit selection.

Example Procedure:

Configure the Primary Display with the display [diSP] as the data source by setting Code 1 to [X50]. See diagram at the bottom of the page for data source selection options.



Programming Tip

To enter the Main Programming Mode press the **P** and **↑** buttons at the same time. To exit and return to the operational display, press the **P** and **↑** buttons again at the same time.

At the end of any procedure (Step 8 in this procedure) the **P** must be pressed before the **↑** and **↓** buttons are pressed, otherwise the meter returns to the operational display without saving the new settings.

Select Data Source

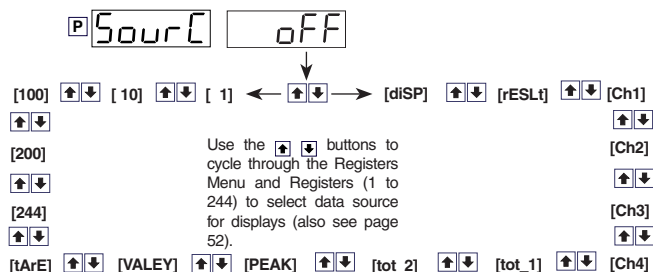

START HERE

CONFIGURE DATA SOURCE

Step 1

Enter Brightness Mode

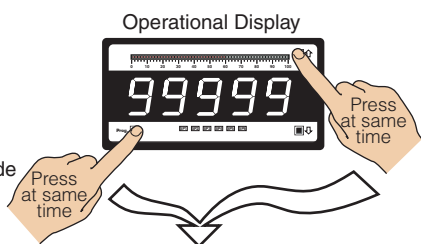

Step 2

Pass Brightness and Calibration Modes and enter Code 1

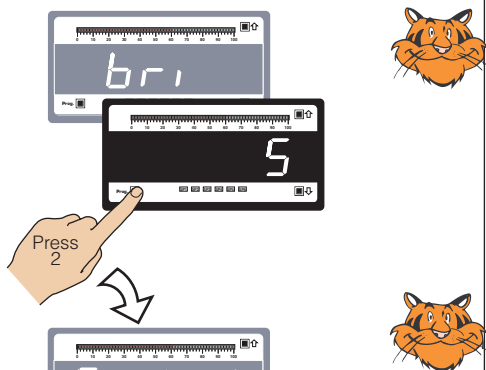

Step 3

Set Code 1 to [X50]:
 1st Digit = X Note relevant
 2nd Digit = 5 Selects data source mode
 3rd Digit = 0 Selects Primary Display

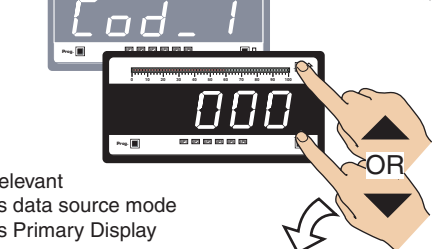

Step 4

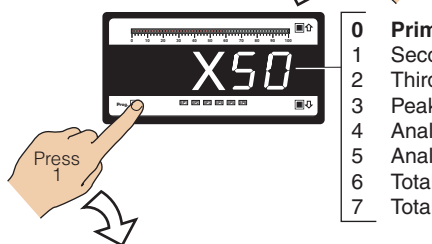

- 0 Primary Display
- 1 Second Display (See Note)
- 2 Third Display (See Note)
- 3 Peak/Valley
- 4 Analog Output 1
- 5 Analog Output 2
- 6 Totalizer 1
- 7 Totalizer 2

Step 5

Select [diSP] as the Data Source from the options listed in the Select Data Source diagram below.

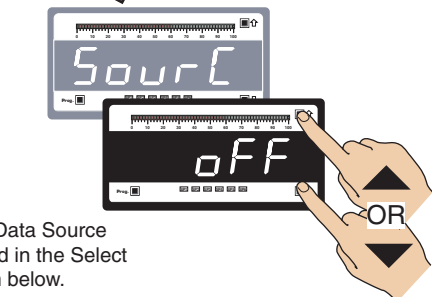

From Step 5

Step 6

Programming Tip

Pressing the **↓** button reaches [000] faster.

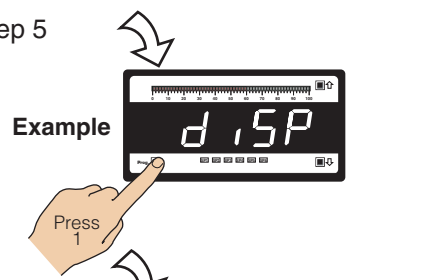

Step 7

Select [000] to leave Code 1

Programming Tip

Pressing the **↑** and **↓** buttons at the same time increases the displayed parameter in increments of 100 counts.

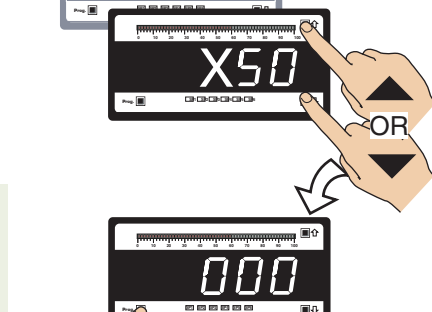

Step 8

Save Data Source setting

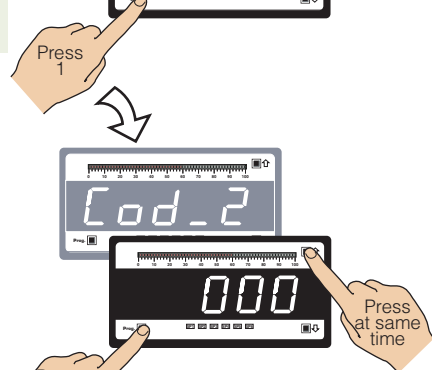

Step 9

Exit Code 2. Return to Operational Display

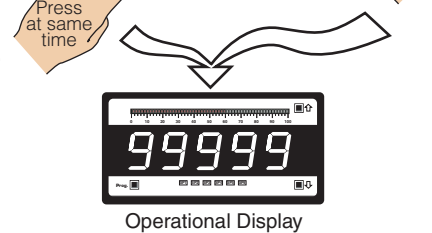

Note:

Options 1 and 2 listed for the 3rd digit in Step 3 above are only for use with meters that have more than one display. With bargraph meters the PRIMARY display is the digital display, and the SECONDARY display is the bargraph display.

Configure Display Format Mode Procedure

The following example procedure describes how to configure the display format mode for the 3rd digit selection and covers:

- Last Digit Rounding.
- Display Units.
- Decimal Point Placement.

Example Procedure:

Configure the display format mode for channel 1 with rounding by 2's, decimal display units, and the decimal point placed between display digits 4 and 5 by setting Code 1 to [X61].

Display Format Mode

P d.1SP 000 Program the three digits to the required display format mode

FIRST DIGIT
LAST DIGIT ROUNDING
0 No rounding
1 Rounding by 2's
2 Rounding by 5's
3 Rounding by 10's

SECOND DIGIT
DISPLAY UNITS
0 Decimal
1 24-hour clock mode Hours: Minutes: Seconds (6-digit version only)
2 12-hour clock mode (12:30 am is displayed as 12:30A. 12:30 pm is displayed as 12:30P)
3 24-hour clock mode Days: Hours:Minutes (6-digit version only)
4 -
5 -
6 -
7 Octal

THIRD DIGIT
DECIMAL POINT PLACEMENT
0 No decimal point
1 -
2 -
3 X.XXXXX
4 X.XXX
5 X.XX
6 X.X
7 Decimal Point set from the rear (X.XXXX to XXXXX) See Note 3. Also See Note 4.

Note:
Selecting 1, 2, or 3 in the 2nd digit of the Display Format Mode configures the display of the selected channel (see Step 4) as a clock.

START HERE

CONFIGURE DISPLAY FORMAT

Step 1

Enter Brightness Mode

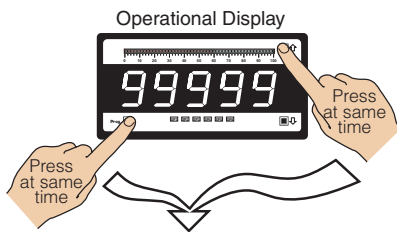

Step 2

Pass Brightness and Calibration Modes and enter Code 1

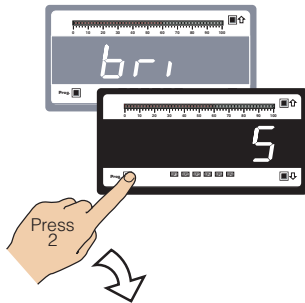

Step 3

Set Code 1 to [X61]:
1st Digit = X Not relevant
2nd Digit = 6 Selects display functions
3rd Digit = 1 Selects Channel 1

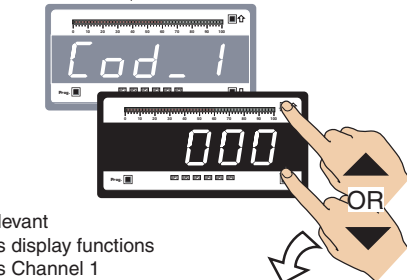

Step 4

Enter the Display format Mode

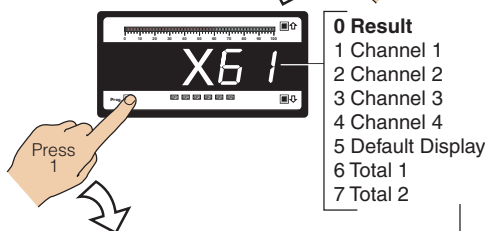

Step 5

Set the Display Format Mode to [106]:

1st Digit = 1 Rounding by 2's
2nd Digit = 0 Decimal display
3rd Digit = 6 Decimal point

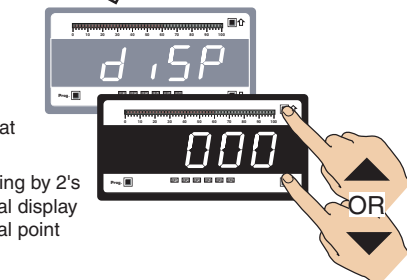

From Step 5

Example

Step 6

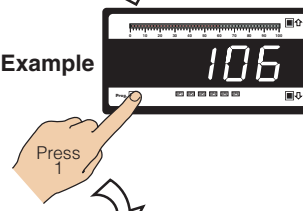

Step 7

Select [000] to leave Code 1

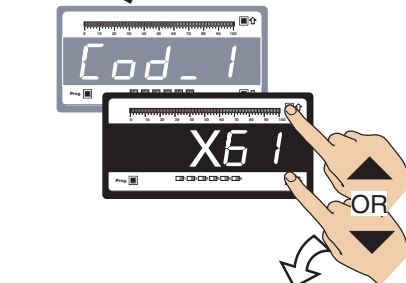

Step 8

Save Display Functions setting

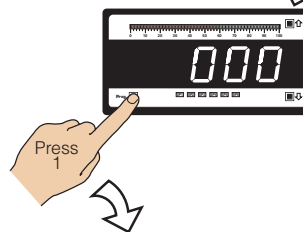

Step 9

Exit Code 2. Return to Operational Display

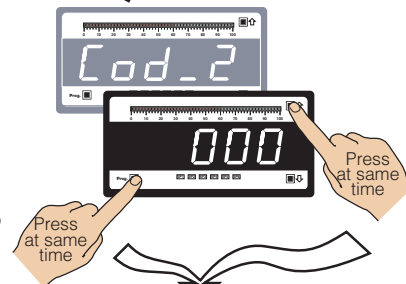

Operational Display

Configure Setpoint Annunciators Procedure

The following example procedure describes how to configure setpoint annunciators.

Example Procedure:

Configure the setpoint annunciators to come ON when the setpoints are OFF (not active) by setting Code 1 to [1XX].

START HERE

CONFIGURE SETPOINT ANNUNCIATORS

Step 1

Enter Brightness Mode

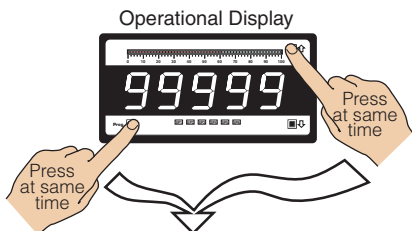

Step 2

Pass Brightness and Calibration Modes and enter Code 1

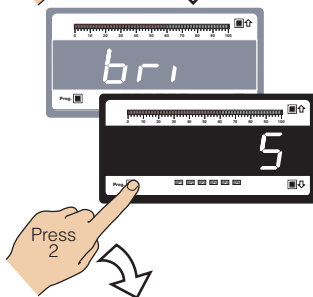

Step 3

Select SP Annunciators setting [1XX]:

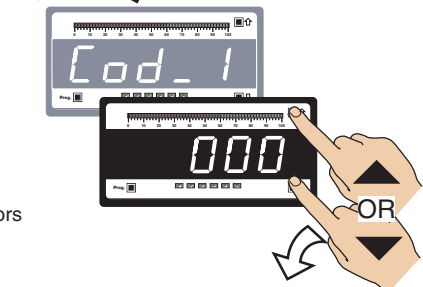

Step 4

Save the settings and enter Code 2

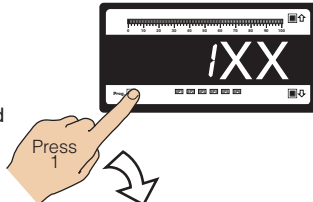

Step 5

Exit Code 2. Return to Operational Display

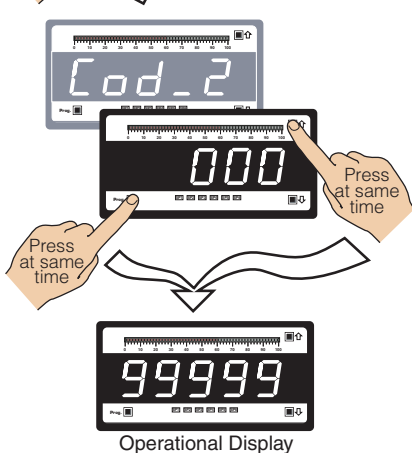

Configure Update at Sample Rate Procedure

The following example procedure describes how to configure the display to update at the sample rate selected in Code 2.

Example Procedure:

Update the display at the sample rate selected in Code 2 [2XX] by setting Code 1 to [X2X].

START HERE

CONFIGURE UPDATE AT SAMPLE RATE

Step 1

Enter Brightness Mode

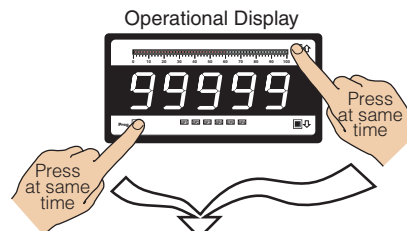

Step 2

Pass Brightness and Calibration Modes and enter Code 1

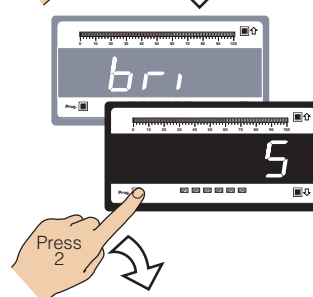

Step 3

Select update at sample rate setting [X2X]:

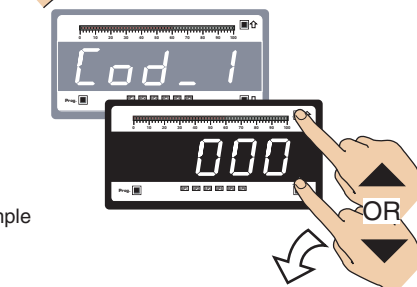

Step 4

Save setting and enter Code 2

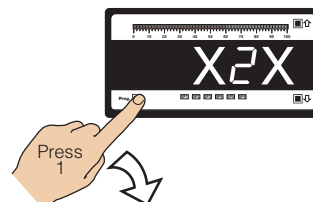

Step 5

Exit Code 2. Return to Operational Display

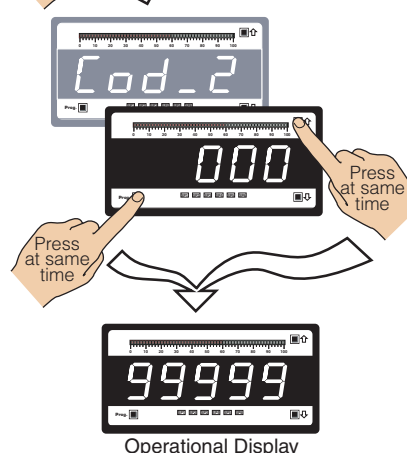

Programming Tip

The *Configuring Setpoint Annunciators* and the *Update at Sample Rate* procedures can be combined so that Code 1 could be set to [12X] (for the above examples) in a single procedure.

Configure Bargraph Colors Procedure

START HERE

CONFIGURE BARGRAPH COLORS

Step 1

Enter Brightness Mode

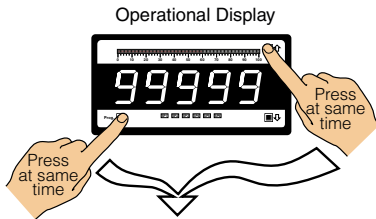

Step 2

Pass Brightness and Calibration Modes and enter Code 10

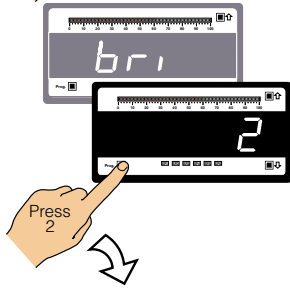

Step 3

Set Code 10 to [2XX]:
1st Digit = 2 Set up colors
2nd Digit = X Not relevant
3rd Digit = X Not relevant

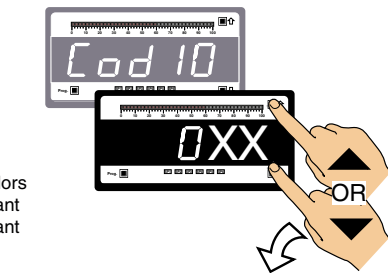

Step 4

Enter the Setup Bargraph Colors mode

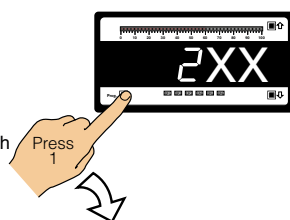

Step 5

Select the color to be displayed for Color 1 (color below the lowest SP)

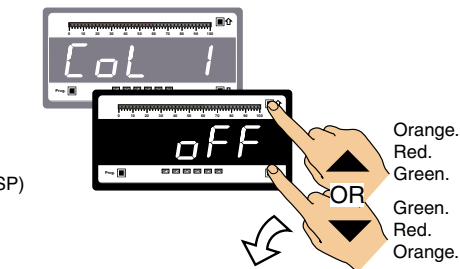

Step 6

Save Color 1 setting and enter Color 2

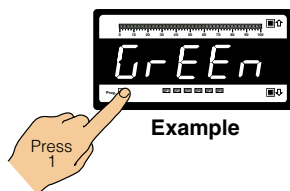

From Step 6

Step 7

Select the color to be displayed for Color 2 (color ABOVE lowest SP)

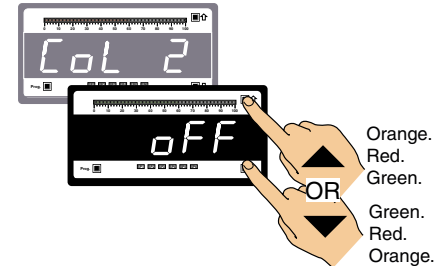

Step 8

Save Color 2 setting and enter Color 3 mode

Note:
Only color settings relevant to selected setpoints need to be set. See Set Up Bargraph Colors for a description of colors and setpoints.

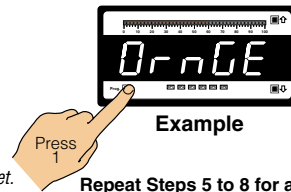

Step 9

Save the color setting for last color and return to Code 10 menu

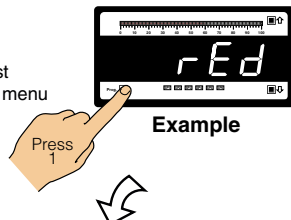

Step 10

Set Code 10 back to [0XX]:
1st Digit = 0 No function
2nd Digit = X Not relevant
3rd Digit = X Not relevant

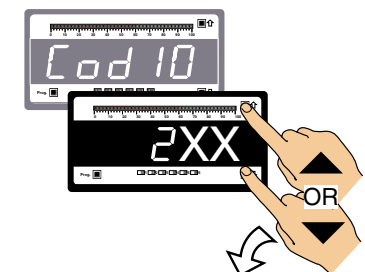

Step 11

Exit Code 10. Return to the Operational Display

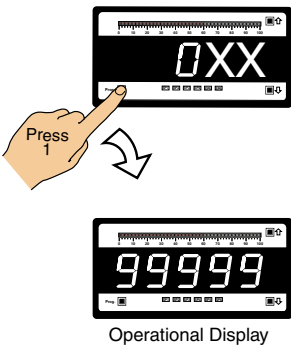

To Step 7

Scale Bargraph using Linear Scaling Procedure

START HERE

CONFIGURE BARGRAPH LINEAR SCALING

Step 1

Enter Brightness Mode

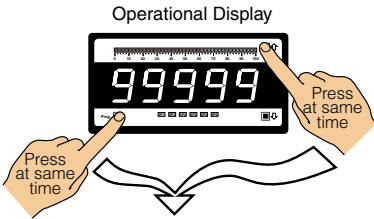

Step 2

Pass Brightness and Calibration Modes and enter Code 10

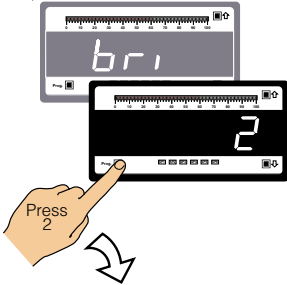

Step 3

Set Code 10 to [3X0]:
1st Digit = 3 Set Up Bar Scaling
2nd Digit = X Not relevant
3rd Digit = 0 Linear

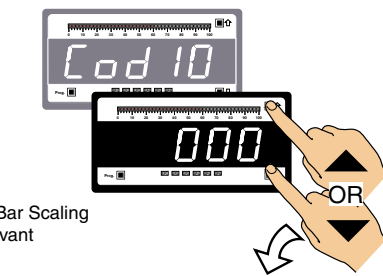

Step 4

Enter the bar low mode

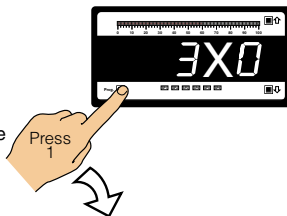

Step 5

Adjust the display to the required bar low [bAr_L] setting

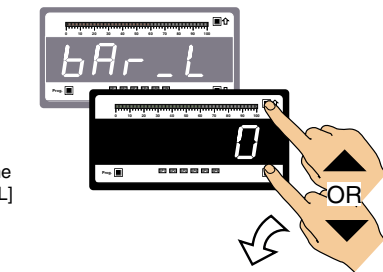

Step 6

Save [bAr_L] setting and enter bar high mode

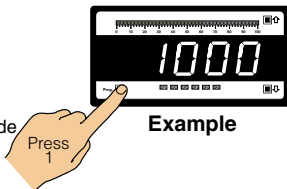

From Step 6

Step 7

Adjust the display to the required bar high [bAr_h] setting

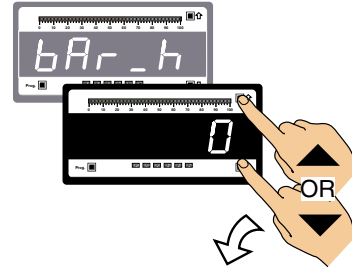

Step 8

Save [bAr_h] setting and enter bar nominal mode

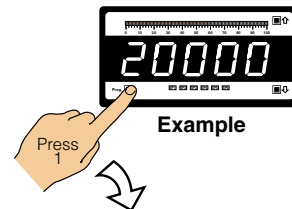

Step 9

Adjust the display to the required bar nominal [bAr_n] setting

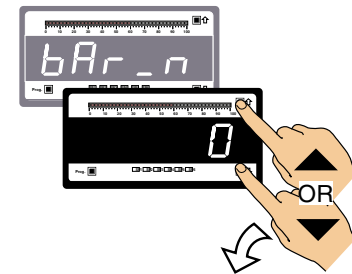

Step 10

Save the [bAr_n] setting and return to Code 10 menu

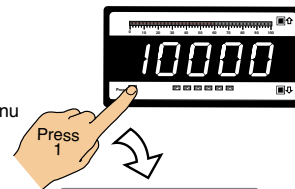

Step 11

Select bargraph display format and set Code 10 to [0X0]:
1st Digit = 0 No function
2nd Digit = X Select display format
3rd Digit = 0 Linear

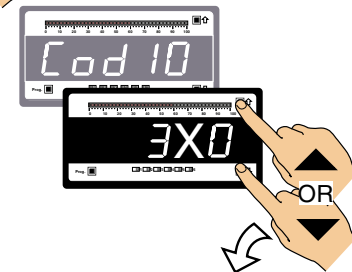

- 0 Setpoints on Bar
- 1 Peak, valley on Bar
- 2 -
- 3 -
- 4 MIN/MAX with setpoints
- 5 -
- 6 -
- 7 Bar only (No setpoints on bar)

Step 12

Exit Code 10. Return to the Operational Display

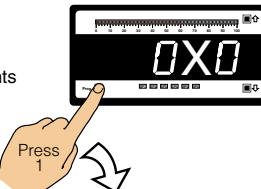

Operational Display

Scale Bargraph using Logarithmic Scaling Procedure

START HERE

CONFIGURE BARGRAPH LOGARITHMIC SCALING

Step 1
Enter Brightness Mode

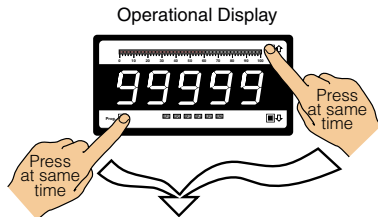

Step 2
Pass Brightness and Calibration Modes and enter Code 10

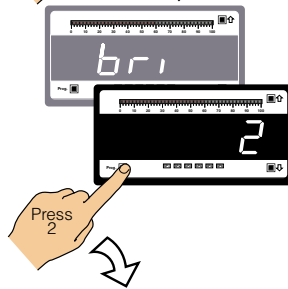

Step 3
Set Code 10 to [3X3]:
1st Digit = 3 Set Up Bar Scaling
2nd Digit = X Not relevant
3rd Digit = 3 Log - 10 Bar/Decade

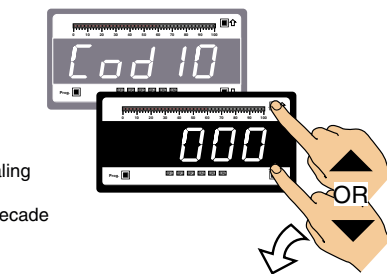

Step 4
Enter the reference [rEF] mode

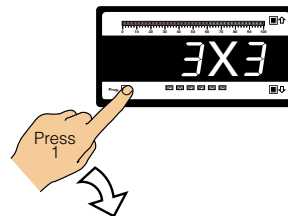

Step 5
Adjust the display to the required reference [rEF] setting

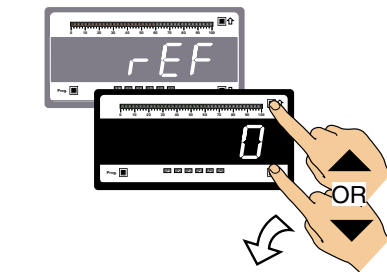

Step 6
Save [rEF] setting and enter bar nominal mode

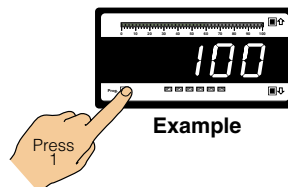

From Step 6

Step 7
Adjust the display to the required bar nominal [bAr_n] setting

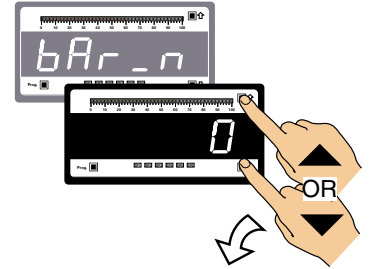

Step 8
Save [bAr_n] setting and return to Code 10

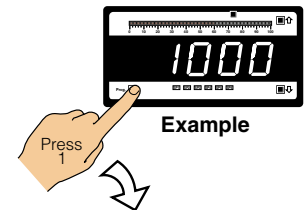

Step 9
Select bargraph display format and set Code 10 to [0X0]:
1st Digit = 0 No function
2nd Digit = X Select display format
3rd Digit = 3 Log-10 Bar

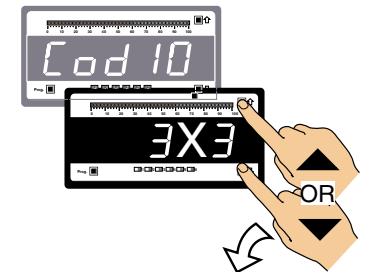

- 0 Setpoints on Bar
- 1 Peak, valley on Bar
- 2 -
- 3 -
- 4 MIN/MAX with setpoints
- 5 -
- 6 -
- 7 Bar only (No setpoints on bar)

Step 10
Exit Code 10. Return to the Operational Display

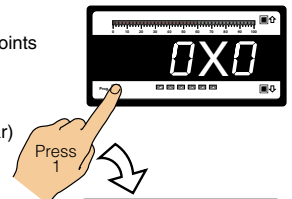

To Step 7

[Code 2] - Channel 1 Measurement Task & Sampling Rate

The Tiger 320 Series meter can be configured to measure almost any input signal. The measurement task and sampling rate for Channel 1 (CH1) is configured in the three digits of Code 2. The diagram below lists the available configuration selections in Code 2.

Example Procedure:

Configure CH1 for a voltage input with 10 samples/second (60 Hz) sampling rate and output rate of 0.1 seconds by setting Code 2 to [000].

FIRST DIGIT	SECOND DIGIT	THIRD DIGIT
CODE 2 – CHANNEL 1 MEASUREMENT TASK AND SAMPLING RATE		
ANALOG SAMPLE RATE 0 Sample Rate: Typically 10 samples/second (60 Hz) Output Rate: 0.1 seconds See Example 1 Sample Rate: Typically 10 samples/second (50 Hz) Output Rate: 0.1 seconds See Example 2 Sample Rate: Typically 10 samples/second (60 Hz) Output Rate: 10 milliseconds See Example 3 Sample Rate: Typically 10 samples/second (50 Hz) Output Rate: 10 milliseconds See Example <i>Note:</i> Output Rate refers to setpoint and macro outputs, and input rates from smart input modules. <i>Note:</i> All above sample rates are quoted for single channel operation. Where more than one channel is available, sample rates are divided by the number of active channels. See Example.	MEASUREMENT TASK 0 Voltage, Current 1 TC (3rd digit selects type of TC) 2 RTD 3-wire (3rd digit selects type of RTD) 3 RTD 2- or 4-wire (3rd digit selects type of RTD) 4 Frequency 5 Period 6 Counter 7 Smart Input Module Example: 10 Samples/Second 1 Channel = 10 samples/second 2 Channels = 5 samples/second 3 Channels = 3.33 samples/second 4 Channels = 2.5 samples/second	FOR VOLTAGE 0 No function 1 Peak detector 2 Pressure with Auto-cal FOR THERMOCOUPLE 0 Type J 1 Type K 2 Type R 3 Type S 4 Type T 5 Type B 6 Type N 7 Select user defined table set up in CAL [24X] FOR RTD TYPE (2-, 3-, 4- WIRE) 0 Resistance 1 RTD 385 2 RTD 392 3 RTD 120 4 Cn 10 FREQUENCY RANGE 0 99.999 Hz range from 0.010 Hz 1 99.999 Hz range from 2.000 Hz 2 999.99 Hz range from 0.01 Hz 3 999.99 Hz range from 2.00 Hz 4 9999.9 Hz range from 0.1 Hz 5 9999.9 kHz range from 2.0 Hz 6 99 kHz range from 1 Hz (1 s gate) 7 655.35 kHz range from 10 Hz (0.1 s gate) PERIOD MEASUREMENT 0 99.999 s 1 9.9999 s 2 999.99 ms 3 99.999 ms COUNTER/RESIDENT TIMER/CLOCK 0 Counter input with 16 bit Pre-scaler 1 Setting of 16-bit Pre-scaler 2 Debounced Counter with Pre-scaler 3 Up/Down Counter with Pre-scaler 4 0.1 sec Timer with Pre-scaler 5 - 6 External 24-hour clock 7 Internal 24-hour clock SMART INPUT MODULE 0 Output Register 1 1 Output Register 2 2 Output Register 3 3 Output Register 4 4 Output Register 5 5 Output Register 6 6 Output Register 7 7 Smart Input Module Setup.

START HERE

CONFIGURE CH1 MEASUREMENT TASK & SAMPLING RATE

Step 1

Enter Brightness Mode

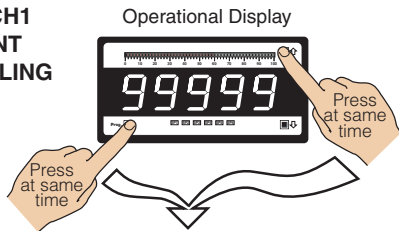

Step 2

Pass Brightness Mode, Calibration Mode, Code 1, and enter Code 2

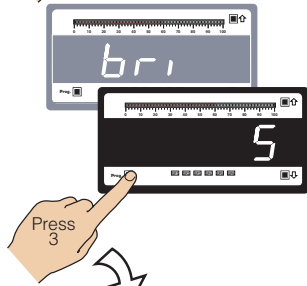

X61 Sets Prescaler	
1 =	0.1 second
10 =	1 second
600 =	1 minute
36000 =	1 Hour***

***Note: For the 1 hour setting, the scale factor for CH1 must be set to 0.1 in the calibration mode setting [111].

Use **↑** **↓** buttons to set

Step 3

Set Code 2 to [000]:
 1st Digit = 0 Selects 10 samples/sec (60 Hz)
 2nd Digit = 0 Selects voltage, current
 3rd Digit = 0 Selects no function

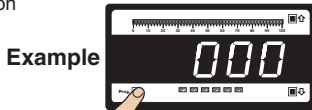

Step 4

Save setting and enter Code 3



Step 5

Exit Code 3. Return to Operational Display

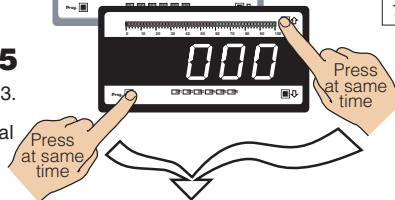

Press **P** **57761** **000**

Use the **↑** **↓** buttons to set the required smart input module code (0 to 377). See *I-Series Input Module Guide (Z87)* for code details.

[CodE 3] - Channel 1 Post Processing & Serial Mode Functions

Post processing functions refer to functions that occur to the input after it has been configured and scaled.

Post processing for Channel 1 (CH1) is configured in the first digit of Code 3. The diagram below lists the available post processing configuration selections in Code 3 (1st digit only).

FIRST DIGIT	SECOND DIGIT	THIRD DIGIT
CODE 3 – CHANNEL 1 FUNCTIONS (POST PROCESSING & SERIAL MODE)		
CH1 POST PROCESSING	32-POINT LINEARIZATION FOR CHANNEL 1	SERIAL MODE
0 Direct Display of Input (no processing) 1 Square Root of Channel 1 2 Inverse of Channel 1 3 -	0 No Linearization on CH1 1 32-point Linearization on CH1 using Table 1 2 32-point Linearization on CH1 using Table 2. <i>See Note 5</i> 3 32-point Linearization on CH1 using Table 3. <i>See Note 5</i> 4 32-point Linearization on CH1 using Table 4. <i>See Note 5</i> 5 125-point Linearization on CH1 (Tables 1 to 4 cascaded). <i>See Note 5</i> 6 32-point Linearization on CH1 (Tables 1 to 4 selected from the rear pins of selected input modules). The selected table is not available if CH2, CH3, or CH4 is operating in the analog output mode. CH1 must be set to Voltage, Current in Code 2 [X0X]. <i>See Note 5</i> 7 - Note: All linearization tables are set up in the Calibration Mode [24X].	0 ASCII Mode 1 Modbus Mode 2 Master mode (used to customize print mode protocols via macro) 3 Print Mode 4 Ethernet Mode. <i>See Note 6</i> 5 DeviceNet Mode (requires DeviceNet hardware module). <i>See Note 6</i>

Note 5:
If only 4 kB memory installed, functions 2 to 6 are not available in:

- Code 3 second digit.
- Code 4 third digit.
- Code 7 second digit.

Note 6:
These functions are not available on all models and in some cases require additional hardware.

START HERE

CONFIGURE CH1 POST PROCESSING FUNCTIONS

Step 1

Enter Brightness Mode

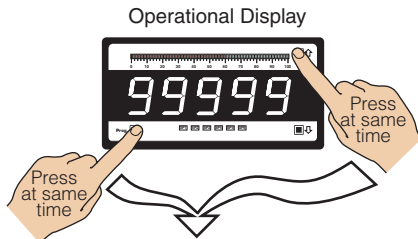

Step 2

Pass Brightness Mode, Calibration Mode, Codes 1 and 2, and enter Code 3

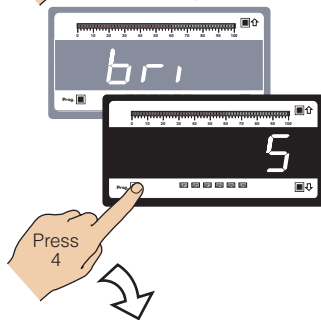

Step 3

Set Code 3 to [100]:
 1st Digit = 1 Square root of CH1
 2nd Digit = 0 No linearization
 3rd Digit = 0 ASCII Mode

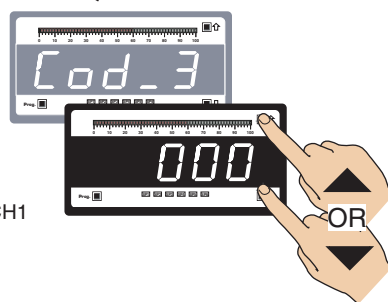

Example Procedure:

Configure the meter to apply square root to the CH1 signal by setting Code 3 to [100].

From Step 3

Step 4

Save Post Processing setting

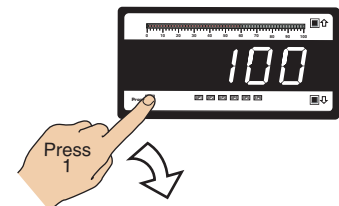

Step 5

Exit Code 4. Return to Operational Display

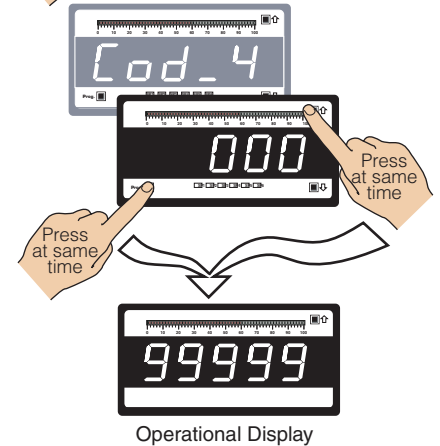

Programming tip

For full details on the Serial Mode, see *Serial Communications Output Module* supplement.

Print Mode – Data Printing Direct to Serial Printer

Print mode data logging is a simple method of capturing data using the meter's print mode. The data can be printed directly to a serial printer from the meter.

The print mode uses the meter's serial communications port to connect to a remote serial printer. The data can be printed with or without a Day: Month: Year or Hours: Minutes: Seconds time stamp.

Time stamp settings are configured in Code 8.

Print Mode – Data Printing Direct to PC

The print mode can also be used to print data to a PC where it is logged in a Windows Terminal program.

The print mode uses the meter's serial communications port to connect to the PC. The data can be logged with or without a Day: Month: Year or Hours: Minutes: Seconds time stamp.

Time stamp settings are configured in Code 8.

[CodE 5] - Channel 3 Functions

Code 5 is a single code that combines all the configuration and post processing functions available for Channel 3.

When a **triple input** signal conditioner is installed, the third input signal is processed and displayed on CH3.

Post processing and measurement task functions for CH3 are configured in the 1st, 2nd, and 3rd digits of Code 5. The diagram opposite lists the available configuration selections in Code 5.

FIRST DIGIT	SECOND DIGIT	THIRD DIGIT
CODE 5 - CHANNEL 3 FUNCTIONS		
CH3 POST PROCESSING	MEASUREMENT TASK	FOR THERMOCOUPLE
<ul style="list-style-type: none"> 0 Direct Display of Input (no processing) 1 Square Root of Channel 3 2 Inverse of Channel 3 3 4 kB Meters 4 32-point Linearization of CH3 using Table 1 32 kB Meters 32-point Linearization of CH3 using Table 3 <p><i>Note:</i> All linearization tables are set up in the Calibration Mode [24X].</p>	<ul style="list-style-type: none"> 0 No Function 1 Voltage / current 2 TC (3rd digit selects type of TC) 3 RTD (3rd digit selects type of RTD) 4 Real Time Clock & Timer (3rd digit selects type) 5 - 6 - 7 Smart Input Module (3rd digit selects register) 	<ul style="list-style-type: none"> 0 Type J 1 Type K 2 Type R 3 Type S 4 Type T 5 Type B 6 Type N 7 Select user defined linearization table (Table 1) set up in CAL [24X]
		FOR RTD TYPE (2-, 3-, 4- WIRE)
		<ul style="list-style-type: none"> 0 Resistance 1 RTD 385 2 RTD 392 3 RTD 120 4 Cn 10
		FOR REAL-TIME CLOCK & TIMER
		<ul style="list-style-type: none"> 0 HRS:MIN:SEC 1 HRS:MIN 2 - 3 - 4 1 Second Count UP Timer 5 1 Second Count DOWN Timer 6 - 7 -
		FOR SMART INPUT MODULE
		<ul style="list-style-type: none"> 0 Output Register 1 1 Output Register 2 2 Output Register 3 3 Output Register 4 4 Output Register 5 5 Output Register 6 6 Output Register 7 7 Smart Input Module Register 2 <p>Code Setup</p>

Example Procedure:

Configure CH3 to display the square root of a voltage input by setting Code 5 to [11X].

See *I-Series Input Modules Guide (Z87)* for procedures to set up a triple input module.

START HERE

CONFIGURE CH3 FUNCTIONS

Step 1

Enter Brightness Mode

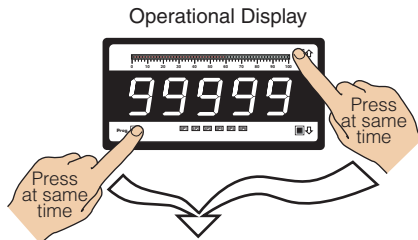

Step 2

Pass Brightness Mode, Calibration Mode, and Codes 1 to 4 and enter Code 5

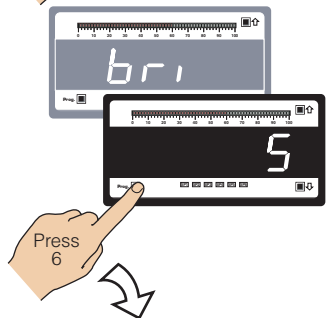

Step 3

Set Code 5 to [11X]:
 1st Digit = 1 Selects square root of CH3
 2nd Digit = 1 Selects voltage, current
 3rd Digit = X Not relevant

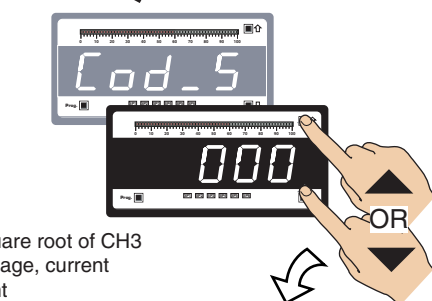

Step 4

Save CH3 setting

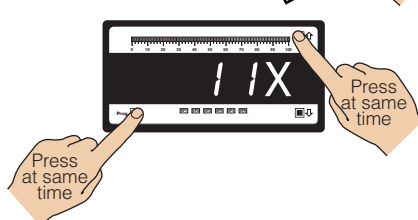

Press **P** 577E2 000

Use the buttons to set the required smart input module code (0 to 377). See *I-Series Input Module Guide (Z87)* for code details.

Step 5

Exit Code 6. Return to Operational Display

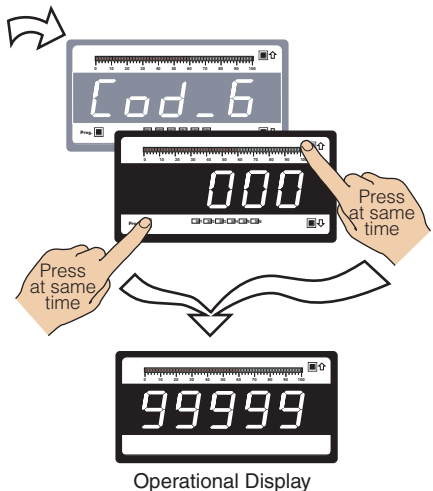

[Code 6] - Channel 4 Functions

Code 6 is a single code that combines all the configuration and post processing functions available for Channel 4.

When a **quad input** signal conditioner is installed, the fourth input signal is processed and displayed on CH4.

Post processing and measurement task functions for CH4 are configured in the 1st, 2nd, and 3rd digits of Code 6. The diagram opposite lists the available configuration selections in Code 6.

Example Procedure:

Configure CH4 for a direct display of voltage input by setting Code 6 to [01X].

FIRST DIGIT	SECOND DIGIT	THIRD DIGIT
CODE 6 - CHANNEL 4 FUNCTIONS		
CH4 POST PROCESSING	MEASUREMENT TASK	FOR THERMOCOUPLE
0 Direct Display of Input (no processing)	0 No Function	0 Type J
1 Square Root of Channel 4	1 Voltage / Current	1 Type K
2 Inverse of Channel 4	2 TC (3rd digit selects type of TC). See Note 7	2 Type R
3 4 kB Meters 32-point Linearization of CH4 using Table 1	3 RTD (3rd digit selects type of RTD). See Note 7	3 Type S
32 kB Meters 32-point Linearization of CH4 using Table 4	4 Real Time Clock and Timer (3rd digit selects type)	4 Type T
<i>Note:</i> All linearization tables are set up in the Calibration Mode [24X].	5 -	5 Type B
	6 -	6 Type N
	7 Smart Input Module (3rd digit selects register)	7 Select user defined linearization table (Table 1) set up in CAL [24X]
		FOR RTD TYPE (2-, 3-, 4- WIRE)
		0 Resistance
		1 RTD 385
		2 RTD 392
		3 RTD 120
		4 Cn 10
		FOR REAL-TIME CLOCK & TIMER
		0 HRS:MIN:SEC
		1 HRS:MIN
		2 -
		3 -
		4 1 Second Count UP Timer
		5 1 Second Count DOWN Timer
		6 -
		7 -
		FOR SMART INPUT MODULE
		0 Output Register 1
		1 Output Register 2
		2 Output Register 3
		3 Output Register 4
		4 Output Register 5
		5 Output Register 6
		6 Output Register 7
		7 Smart Input Module Register 3 Code Setup

Note 7:
For future development.

See *I-Series Input Modules Guide (Z87)* for procedures to set up a quad input module.

START HERE

CONFIGURE CH4 FUNCTIONS

Step 1

Enter Brightness Mode

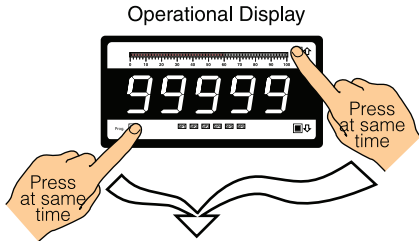

Step 2

Pass Brightness Mode, Calibration Mode, and Codes 1 to 5 and enter Code 6

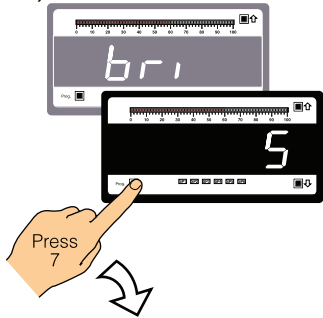

Step 3

Set Code 6 to [01X]:
1st Digit = 0 Selects direct display of CH4 processed signal
2nd Digit = 1 Selects voltage, current
3rd Digit = X Not relevant

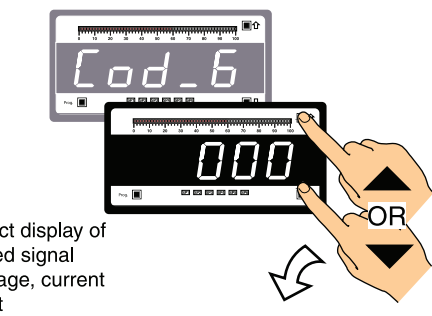

Step 4

Save CH4 setting

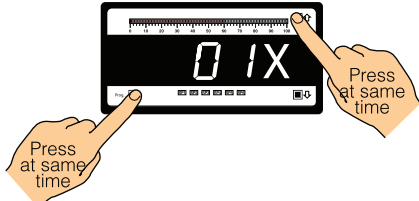

From Step 4

Step 5

Exit Code 7. Return to Operational Display

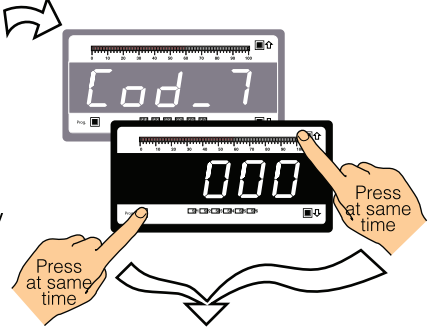

Operational Display

Use the \uparrow \downarrow buttons to set the required smart input module code (0 to 377). See *I-Series Input Module Guide (Z87)* for code details.

[CodE 7] - Result Processing

The third digit of Code 7 performs various math functions between channel 1 and channel 2 and stores this data in the result register.

The data in the result register can then be further processed by the selections made in the 1st and 2nd digits.

FIRST DIGIT
RESULT PROCESSING
0 Direct Display of Result as per processing performed in 2nd or 3rd digit
1 Square Root of Result
2 Inverse of Result
3 -

SECOND DIGIT
CODE 7 – RESULT PROCESSING
32-POINT LINEARIZATION FOR RESULT
0 No Linearization on Result
1 32-point Linearization on Result using Table 1
2 32-point Linearization on Result using Table 2. <i>See Note 5</i>
3 32-point Linearization on Result using Table 3. <i>See Note 5</i>
4 32-point Linearization on Result using Table 4. <i>See Note 5</i>
5 125-point Linearization on Result (Tables 1 to 4 cascaded). <i>See Note 5</i>
6 32-point Linearization on Result (Tables 1 to 4 selected from the rear of the meter). The selected table is not available if CH2, CH3, or CH4 is operating in the analog mode. CH1 must be set to Voltage, Current in Code 2 [X0X]. <i>See Note 5</i>
7 -

THIRD DIGIT
MATHS FUNCTIONS FOR RESULT
0 Result Register not Updated
1 pH Meter (CH1 = T _{buff} , CH2 = pH)
2 Result = CH1, Setpoint 2 = CH2
3 Result = CH1 + CH2
4 Result = CH1 - CH2
5 Result = (CH1 x 20 000)/CH2
6 Result = CH1 x CH2/10 000
7 Result = CH1

Example Procedure:

Configure Code 7 to add the input of CH1 and CH2 and directly display the result by setting Code 7 to [003].

See I-Series Input Modules Guide (Z87) for procedures to set up a dual, triple, or quad input module.

START HERE

CONFIGURE RESULT PROCESSING

Step 1

Enter Brightness Mode

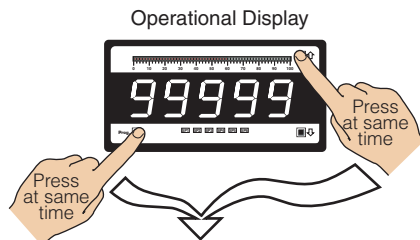

Step 2

Pass Brightness Mode, Calibration Mode, and Codes 1 to 6 and enter Code 7

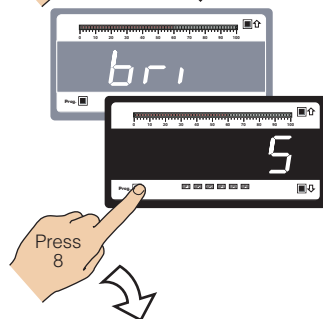

Step 3

Set Code 7 to [003]:
1st Digit = 0 Selects direct display of result
2nd Digit = 0 Selects no linearization on result
3rd Digit = 3 Selects result = CH1+CH2

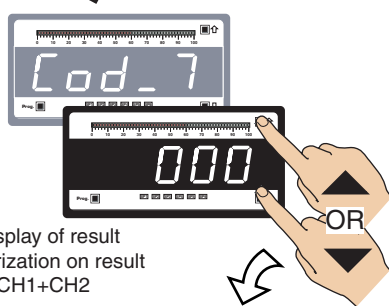

Step 4

Save CH1 & CH2 Result Processing setting

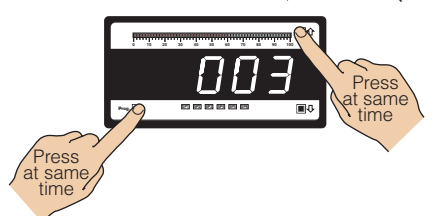

From Step 4

Step 5

Exit Code 8. Return to Operational Display

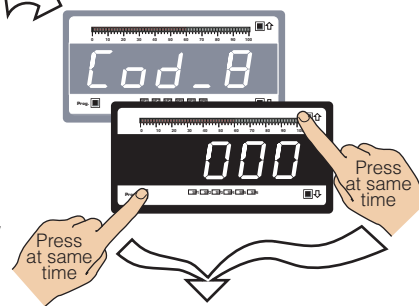

To Step 5



Linearization Table Notes

A base meter with 4 kB memory installed has a single 32-point programmable linearization table available.

For four 32-point programmable linearization tables to be available, the meter requires at least 32 kB of memory to be installed.

Meters with 4 kB Memory

In base meters with 4 kB memory, set up Table 1 in the Calibration Mode to [24X]. This means that Table 1 is available to be applied to:

- CH1 – Selected in Code 3.
- CH2 – Selected in Code 4.
- CH3 – Selected in Code 5.
- CH4 – Selected in Code 6.

Meters with 32 kB Memory

In base meters with 32 kB or more memory, each of the four tables (Tables 1 to 4) are set up in [24X] of the Calibration Mode by selecting the appropriate table number. This means that the four tables are available for the four channels as follows:

- CH1 – All four tables selected in Code 3.
- CH2 – All four tables selected in Code 4.
- CH3 – Table 3 selected in Code 5.
- CH4 – Table 4 selected in Code 6.

[Code 8] - Data Logging & Print Mode

Up to 4000 samples can be logged within the meter in the cyclic or linear FIFO mode and saved for later downloading to a PC, using a terminal evaluation program, or printing directly to a serial printer.

Data logging can be triggered (activated) from a setpoint, the program button, or from an external switch. See the 3rd digit in the diagram below.

Data from up to four selectable registers can be logged with one of the following printer or spreadsheet style time and date stamps. All time and date stamps are generated from an optional real-time clock (see the 2nd digit in the diagram below):

- No time stamp.
- Month - Day - Year. Hours:Minutes:Seconds.
- Day - Month - Year. Hours:Minutes:Seconds.
- Hours:Minutes:Seconds.

Printer style time and date stamps have a carriage return and line feed. Spreadsheet style time and date stamps are continuous on a single line.

See *Serial Communications Module Supplement (NZ202)* for full details on the Data Logging and Print Mode Options.

FIRST DIGIT	SECOND DIGIT	THIRD DIGIT
CODE 8 – DATA LOGGING AND PRINT MODE OPTIONS		
DATA LOG BUFFER TYPE	DATE & TIME STAMP OPTIONS	LOG OR PRINT TRIGGER
0 No Data Logging 1 Cyclic Buffer 2 Linear FIFO Buffer. 3 Reset Buffer Number to 0. <i>Note:</i> <i>Setting Code 8 to [3XX] resets the data log buffer to 0. Once reset, Code 8 must be set back to the required data log buffer setting.</i>	0 Printer Format – No time stamp with print/log 1 Printer Format – Time stamp format 1 [Mth-Day-Yr Hrs:Min:Sec] (with <CR><LF>) 2 Printer Format – Time stamp format 2 [Day-Mth-Yr Hrs:Min:Sec] (with <CR><LF>) 3 Printer Format – Time stamp format 3 [Hrs:Min:Sec] (with <CR><LF>) 4 Spreadsheet Format – No time stamp with print/log 5 Spreadsheet Format – Time stamp format 1 [Mth-Day-Yr Hrs:Min:Sec] 6 Spreadsheet Format – Time stamp format 2 [Day-Mth-Yr Hrs:Min:Sec] 7 Spreadsheet Format – Time stamp format 3 [Hrs:Min:Sec] ALL ABOVE ARE REAL-TIME CLOCK OPTIONS	0 No trigger 1 Trigger on Demand from PROGRAM Button 2 Trigger on Demand from F1 Button 3 Trigger on Demand from F2 Button 4 Trigger on Demand from HOLD Pin 5 Trigger on Demand from LOCK Pin 6 - 7 - <i>Note:</i> <i>Log and/or print will only trigger if enabled.</i>

[Code 9] - Functions for Digital Input Pins

The TEST, HOLD, and LOCK pins are located at the rear of the meter to accommodate external switched digital inputs. When switched to the COMMON pin, they can be programmed in Code 9 to perform remote resetting functions to add to the functionality of the meter.

Note:

CAPTURE, HOLD, and LOCK pins can be a setpoint activation source. See Setpoint Programming mode.

FIRST DIGIT	SECOND DIGIT	THIRD DIGIT
CODE 9 – FUNCTIONS FOR DIGITAL INPUT PINS		
DISPLAY TEST PIN	HOLD PIN	LOCK PIN
0 Display test only 1 Reset Counter Channel 1 and Sub-total at Power-up 2 Reset Counters Channel 1, 2, 3, 4, Total 1, and Total 2 at Power-up 3 Reset Total 1, and Total 2 at Power-up	0 Display Hold 1 Reset Channel 1 2 Reset Total 1 and Total 2 3 Reset Total 2 4 Reset Peak, Valley 5 Reset Tare 6 Set Tare 7 Unlatch (de-energize) all Setpoints	0 Key Lock 1 Reset Channel 1 2 Reset Channel 2 3 Reset Channel 3 4 Reset Channel 4 5 Reset Tare 6 Reset Total 7 Unlatch (de-energize) all Setpoints

Setpoint Programming Mode

All setpoint activation and control settings are selected and configured using the front panel buttons in the **setpoint programming mode**. Or, software configured via the **meter configuration utility program** if the meter is connected to a PC through the serial port. The meter has six software driven setpoints, independently configured to operate within the total span range of the meter and the selected input module.

Relay Output Modules

Five standard relay output module options provide a selection of 20 relay configuration options for 320 Series meters.

Three electromechanical relay output modules support a combination of 5 A Form A and 10 A Form C relays providing 12 configuration options. A solid state relay (SSR) output module supports 400 V, 210 mA DC SSRs and another SSR output module supports 400 V, 140 mA AC / DC SSRs providing a further eight configuration options.

A 22 opto-isolated I/O plug-in module can support six inputs and up to 16 outputs. The standard plug-in module has six inputs and six outputs that can be extended to 16 outputs with a 10 output add-on board.

320 Series Relay Output Module Options

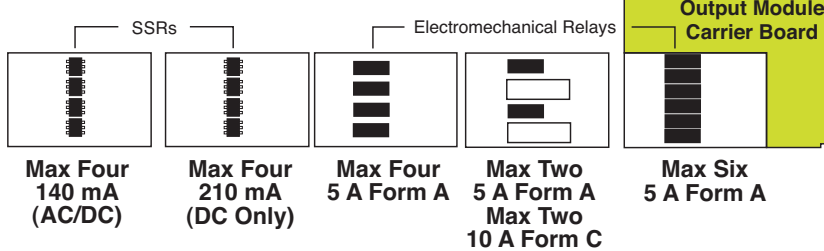

Optional Opto-isolated 22 I/O Plug-in Module

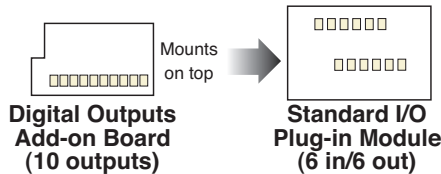

Setpoint Programming Mode

See the *Setpoint Programming Mode Logic Diagram* opposite.

The setpoint programming mode is entered by pressing the meter's **P** and **↓** buttons at the same time.

Setpoint Activation Values

Each setpoint activation value is individually programmed. Setpoint activation values can be set within the total span range of the meter and the selected input module.

Setpoint and Relay Control Settings

See the *Setpoint and Relay Control Settings* diagram on Pages 50 and 51.

The control settings provide access to the following setpoint and relay functions for configuration using the meter's 1st, 2nd, and 3rd digits:

- **1st Digit** – Relay Energize Functions.
- **2nd Digit** – Setpoint Activation Source.
- **3rd Digit** – Setpoint Delay, Timer, and Reset and Trigger Functions.

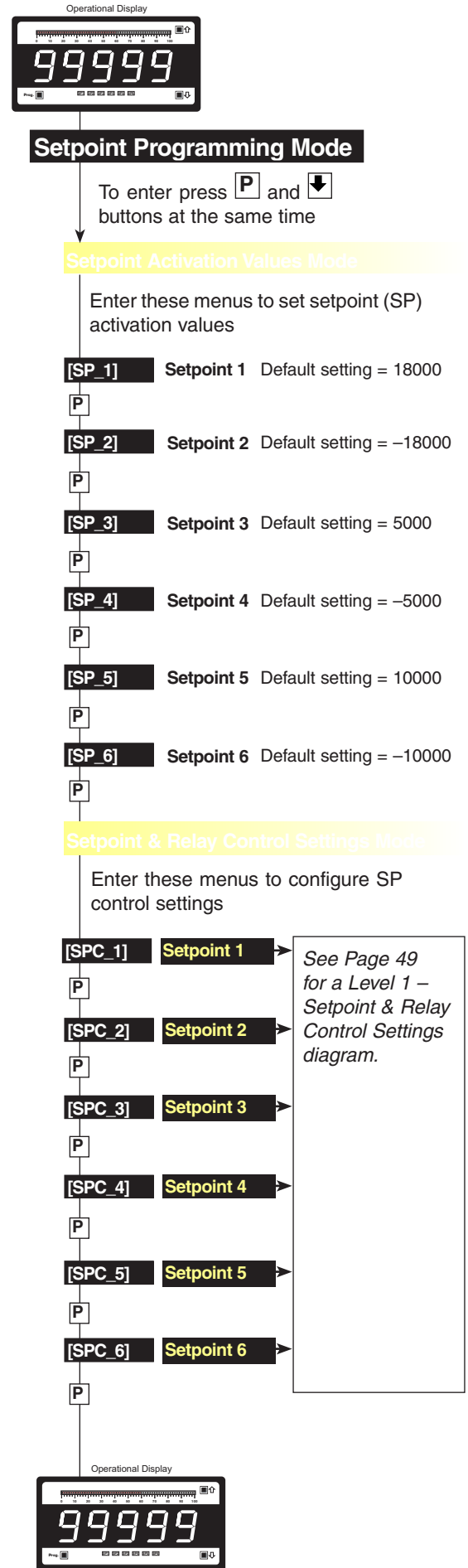

Setpoint Mode Logic Diagram

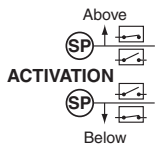

Relay Energize Functions

All setpoints activate at the setpoint value. All relays/setpoints are programmable to energize above or below the setpoint value.

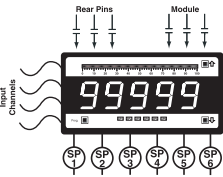

Setpoint Activation Source

Setpoints activate from any input channel, selected meter register, or external switched inputs (digital input pins).

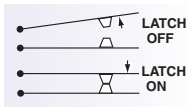

Setpoint Latching

Setpoints can be programmed in relay latching modes.

SP TRIGGER OPERATES ON:

- MAKE EDGE
- BREAK EDGE
- MAKE & BREAK EDGE
- EVERY SAMPLE PERIOD

SP RESET SELECTED REGISTER

SP TRIGGER PRINT

SP TRIGGER LOG DATA



Setpoint Reset & Trigger

Setpoints can be programmed to reset selected registers, or be manually reset. They can also trigger a data print or a data log.



Setpoint Tracking

Setpoint tracking can be applied to setpoints configured in the hysteresis, deviation, or PID modes.

Display Flashing

Display flashing can be applied to setpoints configured in the hysteresis or deviation modes.

Each setpoint can be programmed to make the display flash on and off while the setpoint is active, and keep it flashing until the setpoint de-activates.

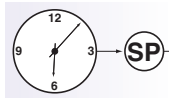

Real-time Clock Option

Any setpoint can be programmed to operate from the real-time clock option.

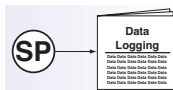

Data Logging

Any setpoint can be programmed to log data within the meter (up to 4000 samples).

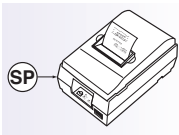

Data Printing to Serial Printer

Any setpoint can be programmed to send data directly to a serial printer.

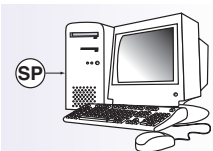

Data Printing to PC

Any setpoint can be programmed to send data directly to a connected PC.



Hysteresis



Deviation

Hysteresis or Deviation

Each relay can operate in a hysteresis or deviation mode.

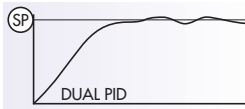

PID Control Settings

The PID (proportional, integral, derivative) control function provides exceptional control stability during control process applica-

tions. PID control is available from the following outputs:

- Setpoint / relay output.
- Analog output.
- Relay and analog output at the same time.

PID control from the setpoint / relay output is available from SP1 and SP2 only.

There are two PID control outputs available via the analog output:

- PID1 – stored in register 50.
- PID2 – stored in register 51.

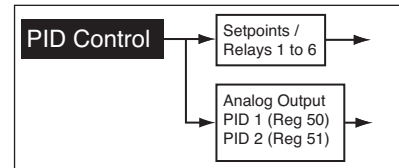

Timer Modes

Each setpoint can be programmed to operate the relay in one of the following seven resident timer modes:

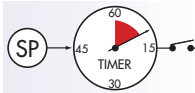

Normal Mode Timer

Single actuation, delay-on-make (DOM) and delay-on-break (DOB).

Normally OFF/Pulsed ON Timers

Repeat ON Mode Timer – multiple actuation, programmable off- and on-time.

Pulse ON Mode Timer – single actuation, programmable DOM and maximum on-time.

1-Shot ON Mode Timer – single actuation, programmable DOM and minimum on-time.

Normally ON/Pulsed OFF Timers

Repeat OFF Mode Timer – multiple actuation, programmable off- and on-time.

Pulse OFF Mode Timer – single actuation, programmable DOB and maximum off-time.

1-Shot OFF Mode Timer – single actuation, programmable DOB and minimum off-time.

Hysteresis or Deviation

Each setpoint can be individually programmed to energize the relay in the hysteresis or deviation mode, with or without initial startup inhibit.

Hysteresis (deadband) is the programmable band above and below the setpoint value that determines when and for how long the relay is energized or de-energized. The setpoint can be programmed to energize the relay above or below the setpoint value.

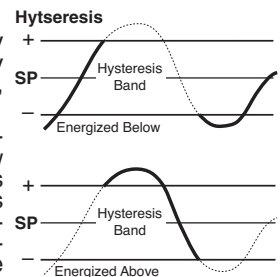

The hysteresis setting can be any value between 0 and 65535 counts. The number of counts selected act both positively and negatively on the setpoint, forming a hysteresis band around the setpoint.

For example, if the setpoint setting is 500 counts and the hysteresis setting is 10 counts, the hysteresis band around the setpoint setting is 20 counts, starting at 490 counts and ending at 510 counts.

Note:

If hysteresis is set with ZERO counts, the relay energizes AT or ABOVE the setpoint value.

Setpoint Programming Mode continued

Deviation (passband) is the programmable band around the setpoint in which the setpoint can be programmed to energize the relay inside or outside the deviation band.

The deviation setting can be any value between 1 and 65535 counts. The number of counts selected act both positively and negatively on the setpoint, forming a deviation band around the setpoint.

For example, if the setpoint setting is 1000 counts and the deviation setting is 35 counts, the deviation band around the setpoint setting is 70 counts starting at 965 counts and ending at 1035 counts.

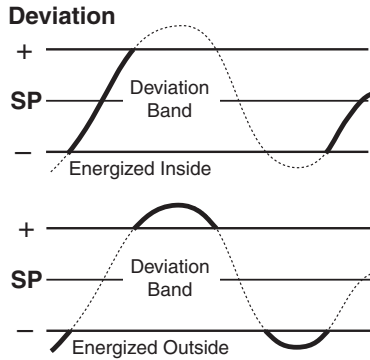

Initial Start-up Inhibit.

On power-on, start-up inhibit prevents the relay from energizing on the first setpoint activation cycle. Depending on how the meter has been programmed, initial start-up inhibit either functions during a falling input signal, or during a rising input signal.

Relay Time Control Modes

The following time control mode settings can cover almost every relay timer application.

All setpoints can be individually programmed to operate a relay in one of the following time control modes above or below the setpoint value.

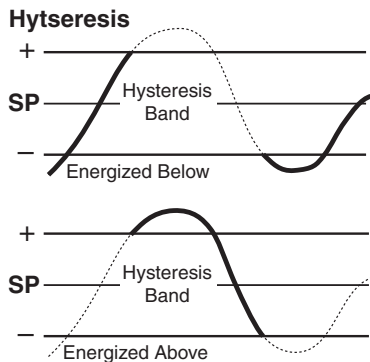

Normal Mode

This mode individually programs a relay's setpoint with delay-on-make (DOM) and delay-on-break (DOB) settings.

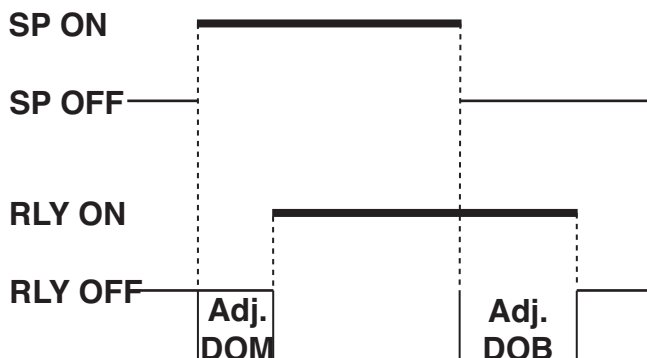

Normally OFF / Pulsed ON Modes

These are delay modes where the relay is normally off and pulses on when the setpoint activates.

Repeat ON Mode

Multiple actuation, programmable on and off time settings.

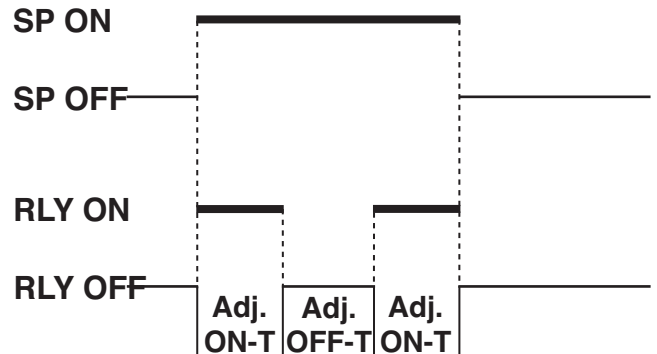

Pulse ON mode (Programmable ON-time)

Single actuation, programmable DOM and on time settings.

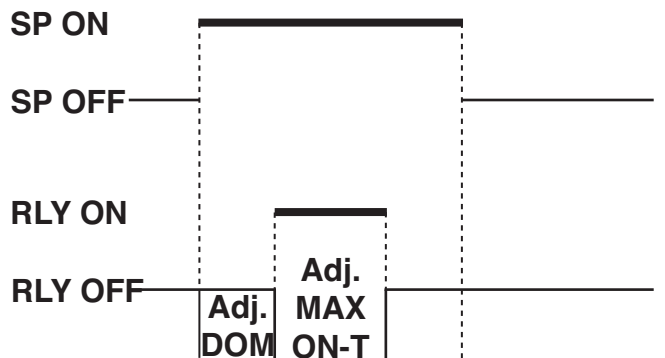

1-Shot ON mode (Programmable Minimum ON-time)

Single actuation, programmable DOM and minimum on time settings.

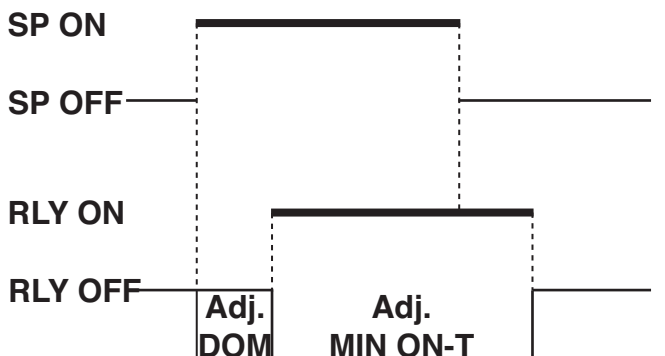

Setpoint Programming Mode continued

Normally ON / Pulsed OFF Modes

These are delay modes where the relay is normally on and pulses off when the setpoint activates.

1-Shot OFF mode (Programmable Minimum OFF-time)

Single actuation, programmable minimum off time and DOB settings.

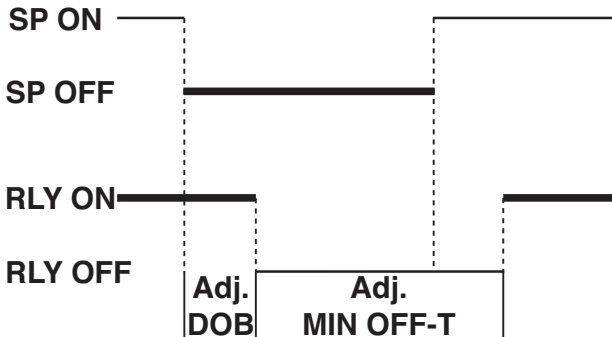

Pulse OFF mode (Programmable OFF-time)

Single actuation, programmable off time and DOB.

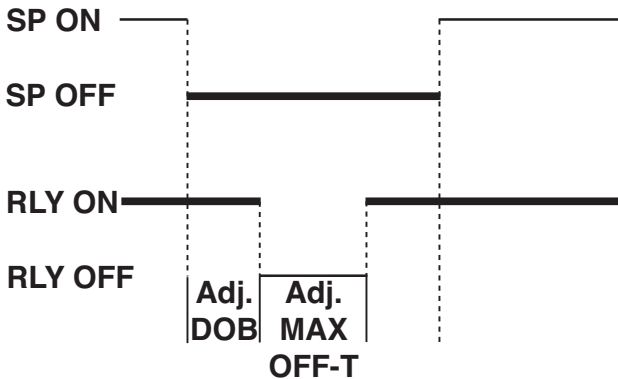

Repeat OFF Mode

Multiple actuation, programmable off and on time settings.

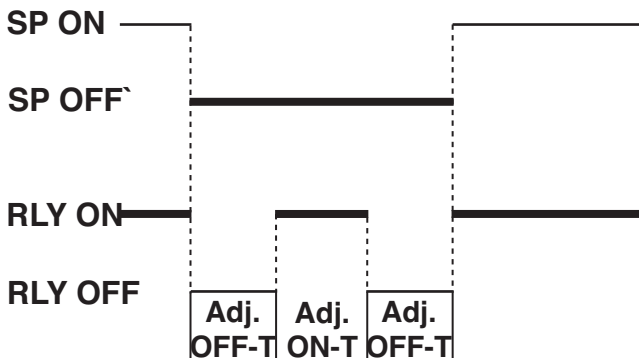

Each setpoint can be individually configured for basic to advanced operations in the following three levels. Each operational level is designed to provide only the required relevant setpoint and relay functions.

The modes at Level 2 and Level 3 can be set to OFF for each individual setpoint, ensuring that no other functions are programmed to influence the setup.

Level 1 Setpoint & Relay Basic Mode

This is an easily programmable mode for users who require the following basic setpoint and relay functions:

First Digit – Relay Energize Functions

Relays programmed to energize above or below the setpoint value.

Second Digit – SP Activation Source

Setpoints programmed to activate from selectable meter registers or one of six external switched inputs.

Third Digit – Setpoint Latching

Relays programmed with latching and manual reset options.

Level 2 Setpoint & Relay Intermediate Mode

Level 2 uses all Level 1 functions and is further extended by the following programmable modes. The functionality of the relay energize functions are extended by allowing the relays to be programmed with or without initial start-up inhibit.

Hysteresis, Deviation & PID Mode

This mode adds extra functionality to the basic mode by providing programmable hysteresis or deviation settings for all setpoints, or PID control from setpoints SP1 and SP2.

Timer Modes

These modes add even more functionality to the basic and intermediate mode by providing each setpoint with a choice of one of seven resident programmable timers.

Level 3 Setpoint & Relay Advanced Mode

Level 3 uses all Level 1 and Level 2 functions combined with reset and trigger functions to provide an extremely powerful advanced mode.

Level 3 enables you to program all setpoints individually for operations normally requiring sophisticated controllers.

Level 1 - Basic Mode - Programming Procedures

Example Procedure:

The following procedure describes how to program setpoint 1 (SP1) for the following **Level 1** setpoint and relay functions:

- SP1 to activate from Channel 1 (CH1).
- Relay to energize above or below SP1 value.
- Relay to latch with manual relay reset.

See *Setpoints and Relays Supplement (NZ201)* for procedures to program all setpoint and relay operational levels (Level 1 to Level 3). (See page 3 for more information).

START HERE

CONFIGURE LEVEL 1 SETPOINT & RELAY FUNCTIONS

Step 1

Enter Setpoint Programming Mode

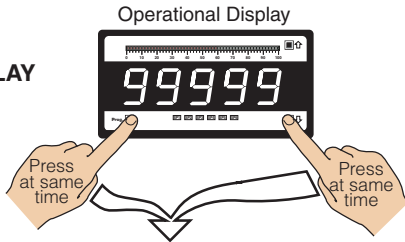

Step 2

Adjust setpoint 1 (SP1) activation value to e.g. 500 counts

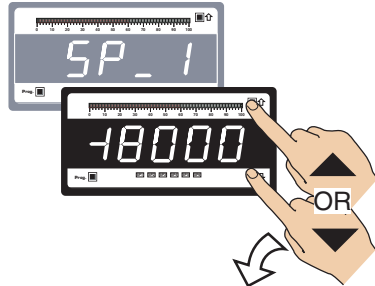

Step 3

Save SP1 activation value setting

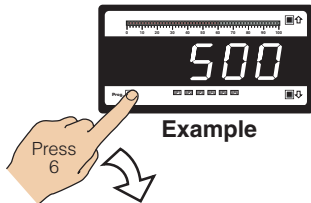

Step 4

Set SPC_1 to [013]:
 1st Digit = 0 Energize above SP1 value
 or 1 to energize below SP1 value
 2nd Digit = 1 Select source for SP1
 3rd Digit = 3 Relay latching with manual reset

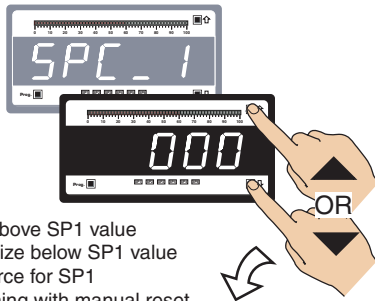

Step 5

Enter SP1 source sub-menu

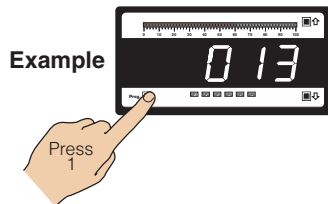

From Step 5

Step 6

Select [CH1] as the SP1 activation source. See diagram on Pages 43 and 44

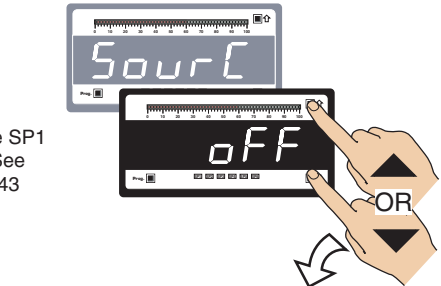

Example



Step 7

Save SP1 control settings



Step 8

Reset 2nd digit to 0. If the 2nd digit is not reset to 0, the meter will constantly cycle thru SPC_1.

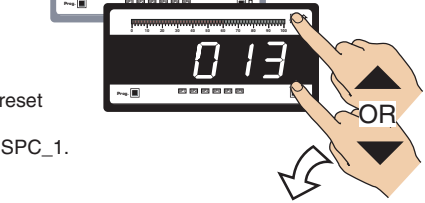

Step 9

Save SP1 control settings

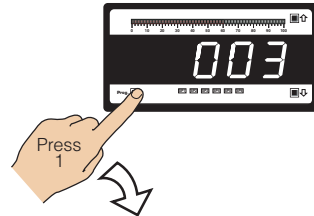

Step 10

Exit SPC_2. Return to Operational Display

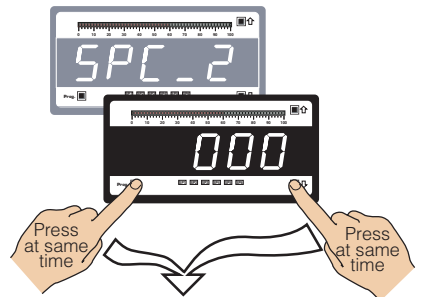

To Step 6



Programming tip

All required setpoint activation values (SP1 to SP6) can be adjusted before programming setpoint and relay control function settings. See *Setpoint Mode Logic Diagram* on Page 50.

Setpoint Programming Mode continued

Setpoint & Relay Control Settings Diagram

The diagram below and continued on Page 51 shows the 1st, 2nd, and 3rd digit control settings for the setpoints and relays.

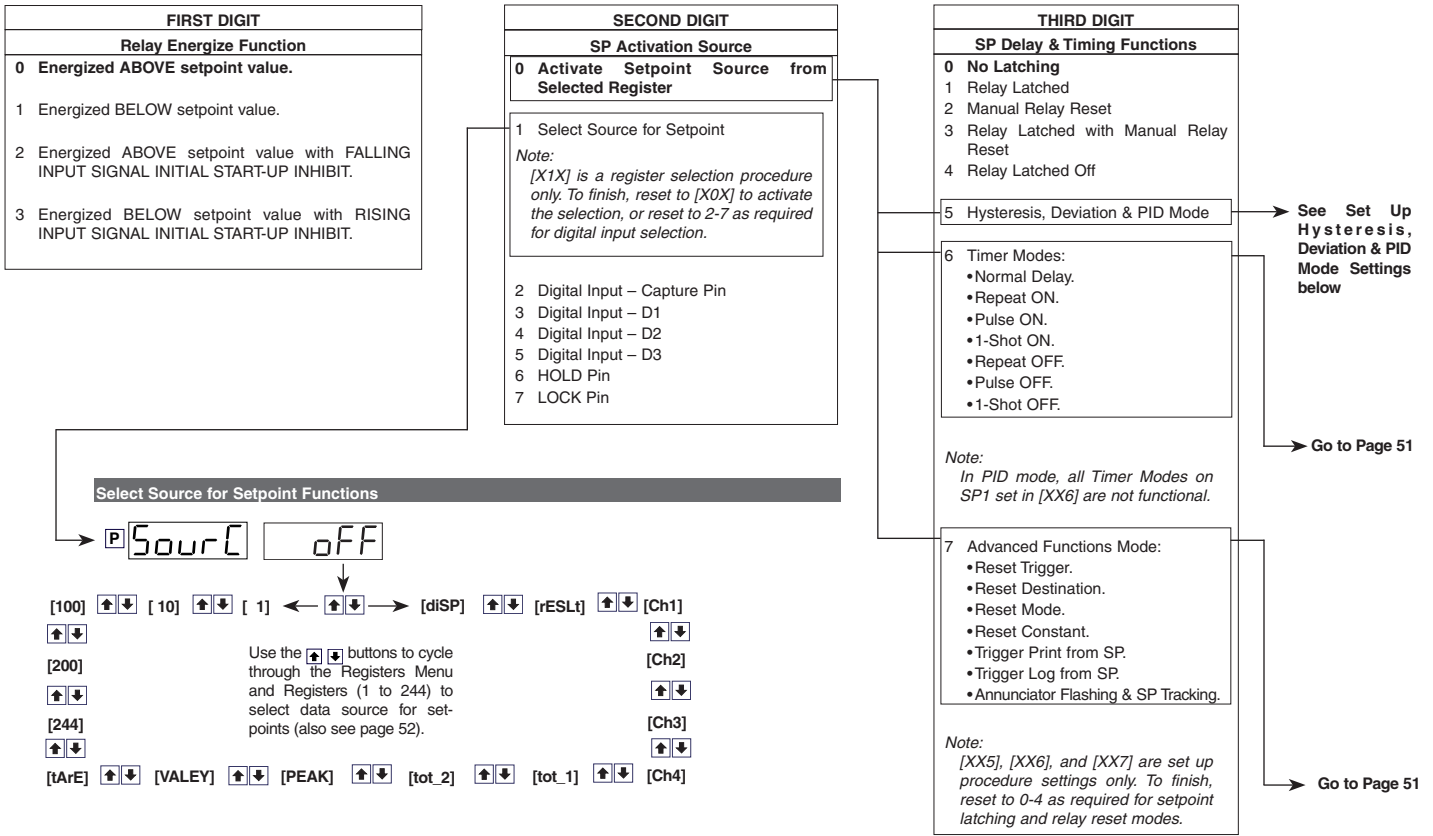

Set Up Hysteresis, Deviation & PID Mode Settings



Programming Tip

If you do not require any of the functions in this mode, ensure it is set to:

Mode [off]

Third digit set to [XX5]

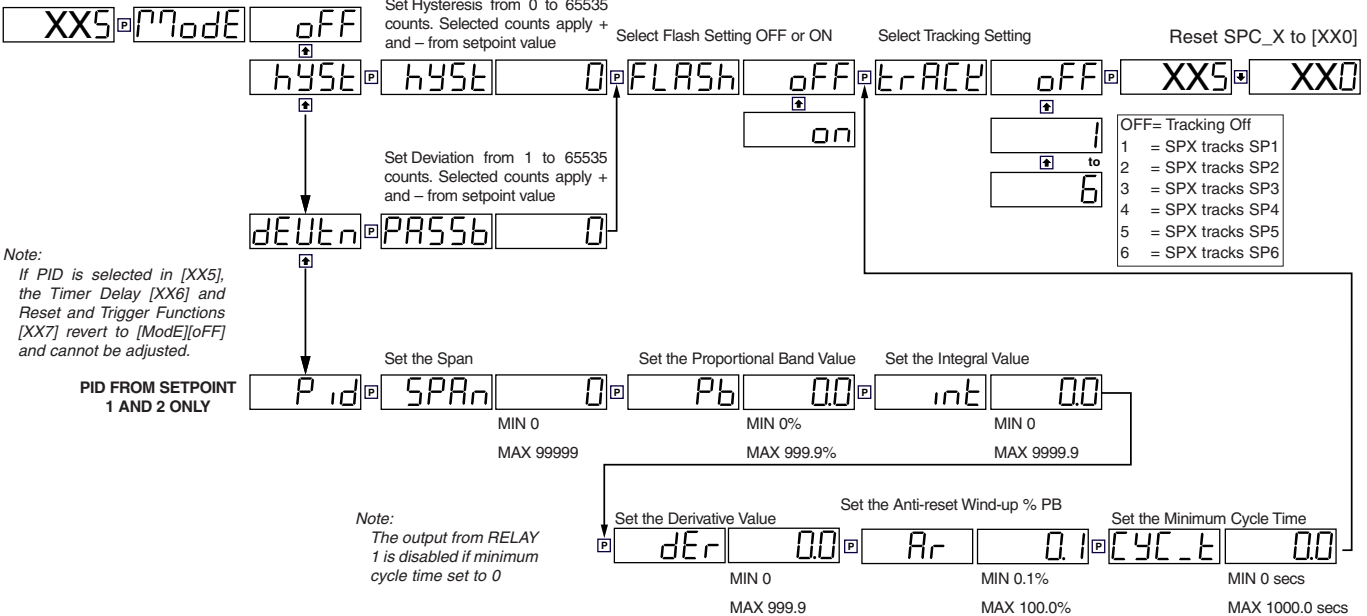

Setpoint Programming Mode continued

Set Up Timer Delay Settings



Programming Tip

If you do not require any of the functions in this mode, ensure it is set to:

timer OFF

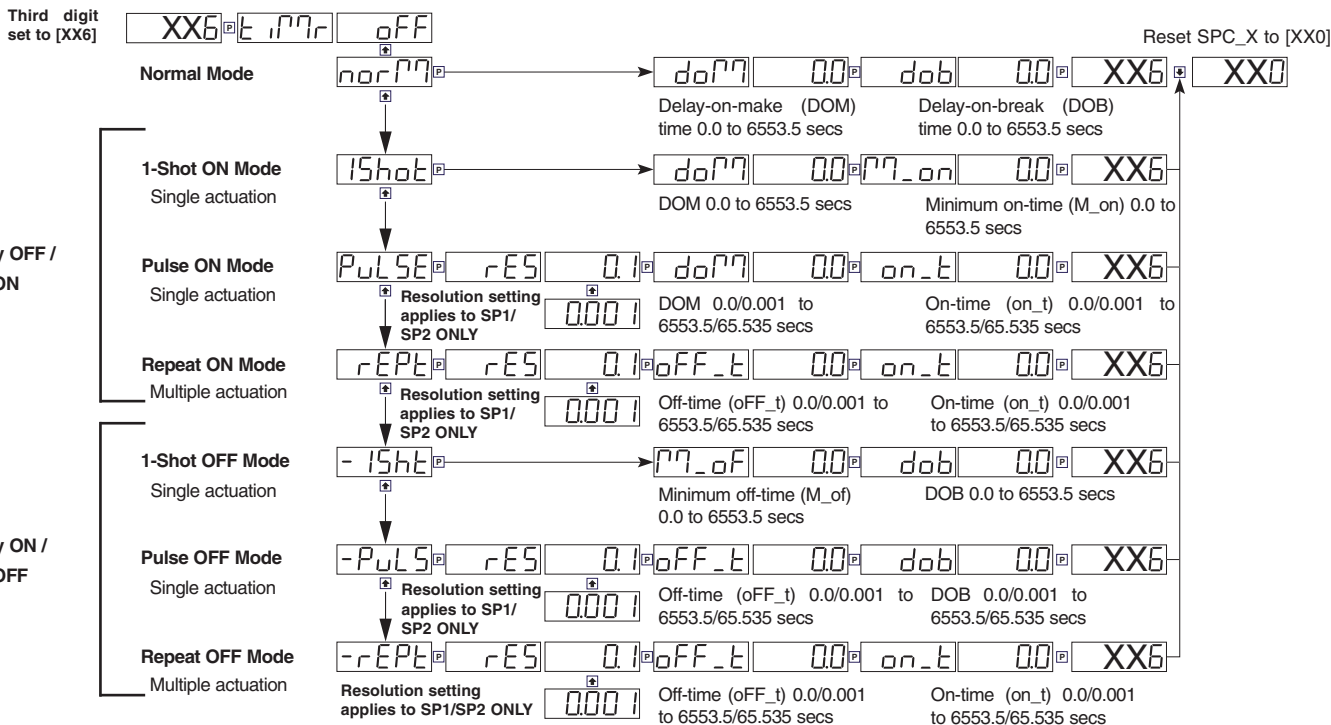

Set Up Register Reset and Setpoint Trigger Functions

Third digit set to [XX7]

Select Trigger Setting

timer OFF

Select Reset Destination Register: [brAKE] [244 to 1] [diSP]

Selecting [oFF] in the Destination Register Reset Setup takes you to Setpoint Print Trigger Setup

Select Print Triggered by Setpoint

Select Log Triggered by Setpoint

Reset SPC_X to [XX0]

- [brAKE] [244 to 1] [diSP]
- [both] [tArE] Use the [up] [down] buttons to cycle through the Registers Menu and Registers (1 to 244) to select which destination register is to be reset by a setpoint (also see page 52).
- [rESL1]
- [LEVEL] [VALEy] [Ch1]
- [PEAK] [tot_2] [Ch2]
- [tot_1] [Ch3]
- [Ch4]

Use the [up] and [down] buttons to cycle through the options

Print on

Log on

Select Reset Mode

Select Reset Constant

- ModeE
- Const
- RES_C
- [-S+C]
- [d+C]

Sets from 0 to -19999

Sets from 0 to 99999

[rEG] Select [rEG] to access the source parameter to select the number of the Modbus register in the meter to be copied to the reset destination register

- [244 to 1] [diSP]
- [tArE] [rESL1]
- [VALEy] [Ch1]
- [PEAK] [Ch2]
- [tot_2] [Ch3]
- [tot_1] [Ch4]

Use the [up] [down] buttons to cycle through the Registers Menu and Registers (1 to 244) to select which register's contents are to be copied into the destination register by a setpoint (also see page 52).



Programming Tip

If you do not require any of the functions in this mode, ensure it is set to:

timer OFF

Registers That Can Be Selected By Front Panel Push Button Programming

A Tiger 320 Series meter has 6,144 registers which are provided for use by the operating system and the powerful Custom Macro Programming system (see page 11).

40 Manually Selectable Registers

Using the front panel buttons, there are 40 registers that may be selected for use within the following functions:

- **[CodE_1] - Display Configuration [X50]**. Selection of a register as the data source for displays, peak and valley, totalizers and analog outputs. (See pages 29 & 31)
- **Setpoint Control Settings [X1X]**. Selection of a register as the data source for a setpoint. (See Page 50)
- **Setpoint Control Settings [XX7]**. Selection of a destination register that is to be reset by a setpoint with the contents of a selected source register. (See Page 51)
- **Setpoint Control Settings [XX7]**. Select which register's contents are to be copied into the destination register by a setpoint. (See Page 51)

The 40 registers that can be selected as a data source, a reset source or a reset destination for the functions above are shown in the table on the right.

The table shows, in seven columns, the functions where these registers can be used.

Where a register is more likely to be used in a particular function, a closed circle ● is shown in the column. For those functions where a register is less likely to be used, an open circle ○ is shown.

No register number is shown for the first 11 functions, because these 11 functions are identified in the display menu for direct selection by their code names.

When cycling through the Registers Menu and then Registers 1 to 244, the numerical Register Set will increment through each decade in turn, from 1 to 0, while the button is held down. When [200] is reached, [oFF] or [tArE] will be displayed. To select a specific number set, the button should be released and pressed again each time the left most decade displays the desired number for that decade.

To quickly exit the numerical 1 to 244 Register Set, hold the [P] button down while cycling through the decades, and release it when [oFF] or [tArE] appears.

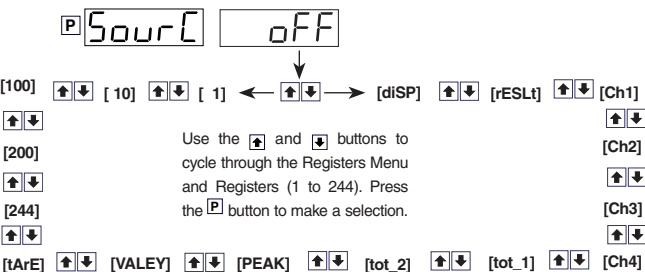

Registers that Should Not be Used

The following registers are contained within the selectable 1 to 244 Register Set, but they should not be selected because they are either reserved for future use, or for use by the operating system only:

15, 38, 47-48, 52-53, 61-64, 123-128, 140-141, 234-244

Any selection of these Registers may cause a malfunction.

Register Functions	Register Numbers	Data Source for Displays	Data Source for Peak & Valley	Data Source for Analog Outputs 1 & 2	Data Source for Totalizers 1 & 2	Data Source for Setpoints	Reset Source	Reset Dest.
Display [diSP]	-		●	●	●	●		
Result [rESL]	-	●	●	●	●	●	●	●
CH1 [Ch1]	-	●	●	●	●	●	●	●
CH2 [Ch2]	-	●	●	●	●	●	●	●
CH3 [Ch3]	-	●	●	●	●	●	●	●
CH4 [Ch4]	-	●	●	●	●	●	●	●
Total 1 [tot_1]	-	●	●	●	●	●	●	●
Total 2 [tot_2]	-	●	●	●	●	●	●	●
Peak [PEAK]	-	○				●	○	●
Valley [VALEY]	-	○				●	○	●
Tare [tArE]	-	○	○	○		●	○	●
PID Output 1	50	○	○	○		○		
PID Output 2	51	○	○	○		○		
Smart Result 1	54	○	○	○				○
Smart Result 2	55	○	○	○				○
Smart Result 3	56	○	○	○				○
Smart Result 4	57	○	○	○				○
Smart Result 5	58							○
Smart Result 6	59							○
Smart Result 7	60							○
Analog Output 1	83	○				○	○	○
Analog Output 2	84	○				○	○	○
Timer 1	95	○				○	○	○
Timer 2	96	○				○	○	○
Smart Reset Offset 1	121							●
Smart Reset Offset 2	122							●
Clock - Seconds	213					○		
Clock - Minutes	214					○		
Clock - Hours	215					○		
Clock - Days	216					○		
Clock - Date	217					○		
Clock - Month	218					○		
Clock - Year	219					○		
Setpoint Latch	221							●
Relay De-energize	222							●
Zero Offset - Result	227					○		
Zero Offset - CH1	228					○		
Zero Offset - CH2	229					○		
Zero Offset - CH3	230					○		
Zero Offset - CH4	231					○		

Resetting and Incrementing Using Setpoints

Setpoints may be used to reset and/or increment registers. In the example shown on the right, 2 liter soft drink bottles are being filled and packed 12 to a case. Using the setpoint reset and increment feature, the number of bottles and the total number of filled cases is easily calculated and displayed. Totalizer 1 counts from 0 to 2, resets, and repeats. CH 2 counts from 0 to 12, resets, and repeats.

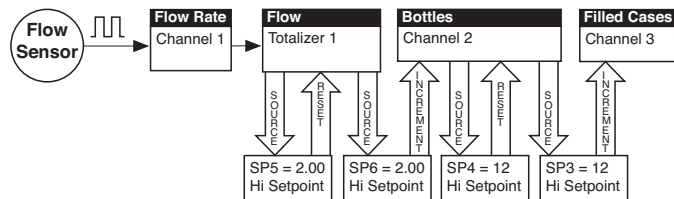

USING SETPOINTS TO INCREMENT AND RESET REGISTERS

Functional Diagram

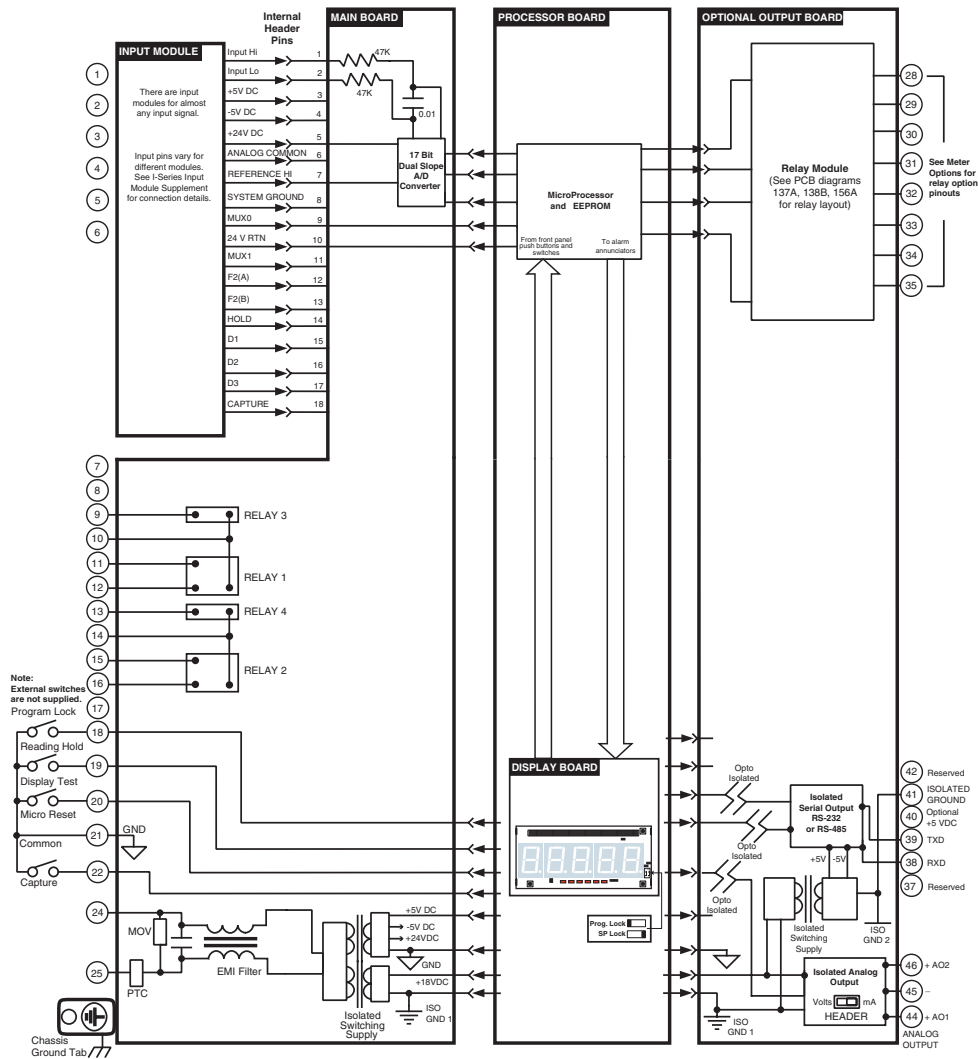

Connector Pinouts

Rear Panel Pinout Diagram

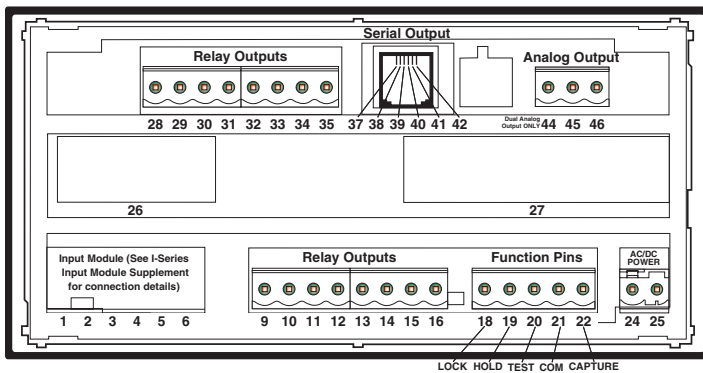

WARNING: AC and DC input signals and power supply voltages can be hazardous. Do Not connect live wires to screw terminal plugs, and do not insert, remove or handle screw terminal plugs with live wires connected.

Input Signal – Pins 1 to 6

See the *I-Series Input Modules Guide (Z87)* for connection details of all input modules. On most single input signal conditioners, usually Pin 1 is the signal high pin (Hi +) and Pin 3 is the signal low pin (Lo -).

Function Pins – Pins 18 to 22

Pin 18 – Program Lock. By connecting the PROGRAM LOCK pin to the COMMON pin (pin 11 on the main PCB), the PROGRAM LOCK pin allows the meter's programmed parameters to be viewed but not changed.

Pin 19 – Hold Reading. By connecting the HOLD READING pin to the

NOTE: The meter uses plug-in type screw terminal connectors for most input and output connections and an RJ-6 phone connector for the optional RS-232 or RS-485 serial outputs.

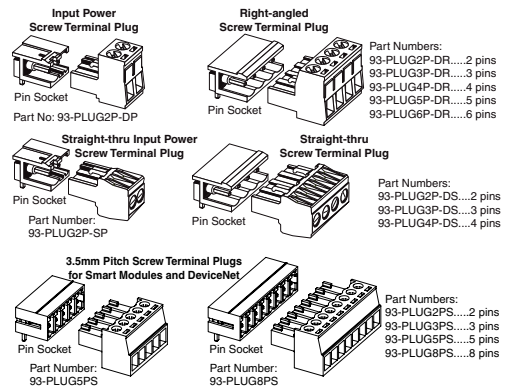

COMMON pin (pin 11), the HOLD READING pin allows the meter's display to be frozen. However, A/D conversions continue and as soon as pin 9 is disconnected from pin 11 the updated reading is instantly displayed.

Pin 20 – Display Test and Reset. The DISPLAY TEST and RESET pin provides a test of the meter's display and resets the microprocessor when the DISPLAY TEST and RESET pin is connected to the COMMON pin (pin 11).

Pin 21 – Common. To activate the HOLD, TEST and RESET, or LOCKOUT pins from the rear of the meter, the respective pins have to be connected to the COMMON pin.

Pins 24/25 – AC/DC Power Input. These are the pins that supply power to the meter. See Power Supply for details of the standard and optional low voltage power supply.

Chassis Ground Tab. Only on versions with metal sheath casing.

Carrier Board Output Pins

Analog Outputs

- Pin 44 – Positive (+) analog output 1.
- Pin 45 – Negative (-) analog output 1 and 2.
- Pin 46 – Positive (+) analog output 2.

Serial Outputs RS-232 or RS-485

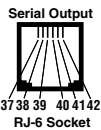

Pin No.	RS-232	RS-485
37	Reserved for future use	Reserved for future use
38	RXD. Received Serial	B (Low)
39	TXD. Transmitted Serial	A (High)
40	+5 VDC to power external converters	+5 VDC to power external converters
41	Isolated Ground	Isolated Ground
42	Reserved for future use	Reserved for future use

Electromechanical Relays

There are 8 relay options available using the relays mounted on the main processor board. The main processor board supports relay combination options using up to four electromechanical relays. A maximum of two 5 A Form A and two 10 A Form C relays. Relay outputs for one to four setpoints can be ordered for factory installation on the main board in any required combination of up to two 10A form C and two 5A form A relays.

Main / Processor Board

PIN Numbers	9	10	11	12	13	14	15	16
Maximum 2 groups of 1 x 10A Form C & 1 x 5A Form A Relays using one Common Pin per group	NO3	COM 1&3	NC1	NO1	NO4	COM 2&4	NC2	NO2
	SP3		SP1		SP4		SP2	
	5 A Form A Relay		10 A Form C Relay		5 A Form A Relay		10 A Form C Relay	
Order Code	Options							
	SP3	SP1	SP4	SP2				
R1	5A	-	-	-				
R2	5A	-	5A	-				
R11	-	10A	-	-				
R12	-	10A	-	10A				
R13	5A	10A	-	10A				
R14	5A	10A	5A	10A				
R15	5A	10A	5A	-				
R16	5A	10A	-	-				
	PIN 10 COMMON for SP1, SP3				PIN 14 COMMON for SP2, SP4			

Relay and Logic I/O Modules

Relay Modules with up to two 5A Form A Relays, and up to two 10A Form C Relays

Order Code	Options			
	SP3	SP1	SP4	SP2
OR11	-	10A	-	-
OR12	-	10A	-	10A
OR23	-	10A	5A	10A
OR14	5A	10A	5A	10A
OR15	5A	10A	5A	-
OR16	-	10A	5A	-

Relay Modules with up to four 5A Form A Relays

Order Code	Options			
	SP1	SP2	SP3	SP4
OR31	5A	-	-	-
OR32	5A	5A	-	-
OR33	5A	5A	5A	-
OR34	5A	5A	5A	5A

Relay Modules with five or six 5A Form A Relays

Order Code	Options					
	SP1	SP2	SP3	SP4	SP5	SP6
OR45	5A	5A	5A	5A	5A	-
OR46	5A	5A	5A	5A	5A	5A

TTL / 5V Output

Order Code	Options					
	SP1	SP2	SP3	SP4	SP5	SP6
OR71	0 to 5V	0 to 5V	0 to 5V	0 to 5V	0 to 5V	0 to 5V

Flash Card Memory Module

Order Code	Options
OR91	MODULE WITH 4 MEG MEMORY

Relay Modules with up to 4 Independent 400V (210mA DC only) or (140mA AC/DC) SSRs

Order Code	Options			
	SP1	SP2	SP3	SP4
OR51, OR61	210mA, 140mA	-	-	-
OR52, OR62	210mA, 140mA	210mA, 140mA	-	-
OR53, OR63	210mA, 140mA	210mA, 140mA	210mA, 140mA	-
OR54, OR64	210mA, 140mA	210mA, 140mA	210mA, 140mA	210mA, 140mA

Open Collector Output

Order Code	Options					
	SP1	SP2	SP3	SP4	SP5	SP6
OR72	OC 1	OC 2	OC 3	OC 4	OC 5	OC 6

Opto Isolated I/O Module for External Breakout Box with 6 Outputs & 6 Inputs, or 16 Outputs & 6 Inputs

Order Code	Options		
	NPN Open Collector Setpoint	MACRO Setpoint	Sink/Source Logic Input
OR81	6 Outputs	-	6 Inputs
OR82	6 Outputs	10 MACRO Outputs	6 Inputs

Modular Construction

The Tiger 320 Series of 32-bit Programmable Meter Controllers incorporates, in one instrument, all the different functions required by today's automation and process control applications. This is made possible by modular construction, around standard case sizes, built to American, European, and Japanese standards.

The range comes with a wide variety of display options, including 5 or 6-digit numeric or alphanumeric displays, 6-digit LCD displays, and 51 or 101-segment red, green, or tri-color straight and circular bargraphs.

All meters are housed in one of three DIN case sizes, or the popular 4" ANSI case, and provide the ideal solution for your measurement and process control applications.

Modular construction ensures you don't have to pay for unnecessary hardware. Simply order the input and output options to suit your application.

320 Series Base Meter

- Power Supply – standard or optional low voltage.
- Processor.
- Display – red, green, or super bright red LEDs

Input Signal Conditioning Modules

Select from over 120 single, dual, triple, or quad inputs covering almost every input signal type.

Standard Serial Output Carrier Board

Relay Modules

Electromechanical Relays

- Max 6 Form A
- Max 2 Form A, 2 Form C
- Max 4 Form A

Solid State Relays

- DC only
- AC / DC

Opto Isolated I/O Module

- 6 Outputs, 6 Inputs
- 16 Outputs, 6 Inputs

Open Collector / TTL / 5V Output

- 0 to 5V
- 0 to V+

Flash Card Memory Module

- Module with 8 Meg Memory
- Module with 16 Meg Memory

Serial Output Modules

- RS-232 Module*
- RS-485 Module*

Mount on a standard carrier board.

*RS-232 and RS-485 modules cannot be used with the optional DeviceNet or Ethernet Carrier Boards.

Analog Output Modules

- 0-20 mA
- 0-10 VDC
- Dual 0-10 VDC

Tiger 320 Series GI Modular Construction

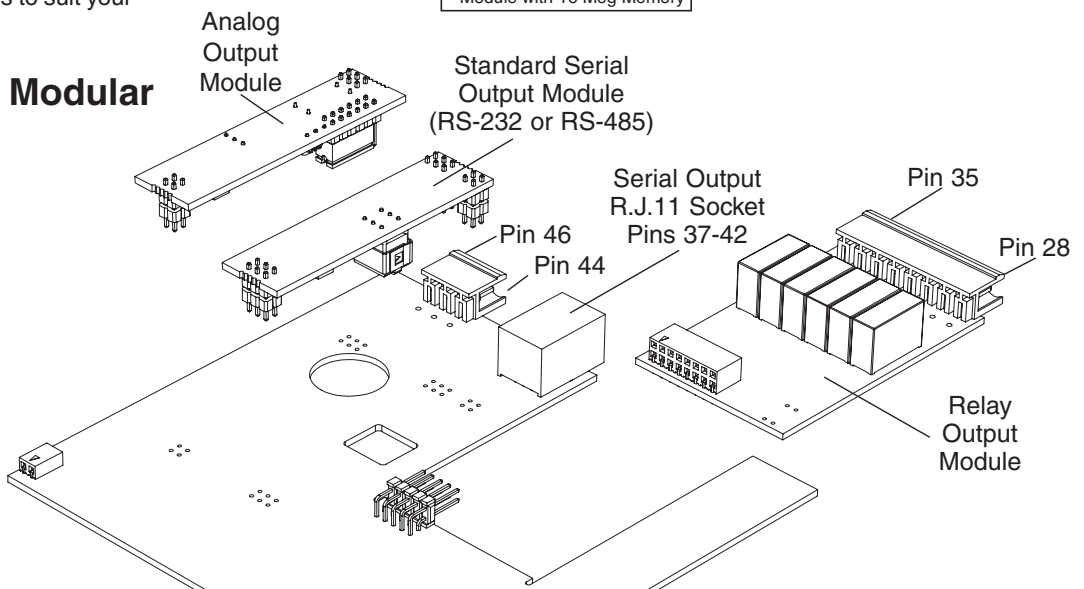

Exploded View of Meter Modular Boards

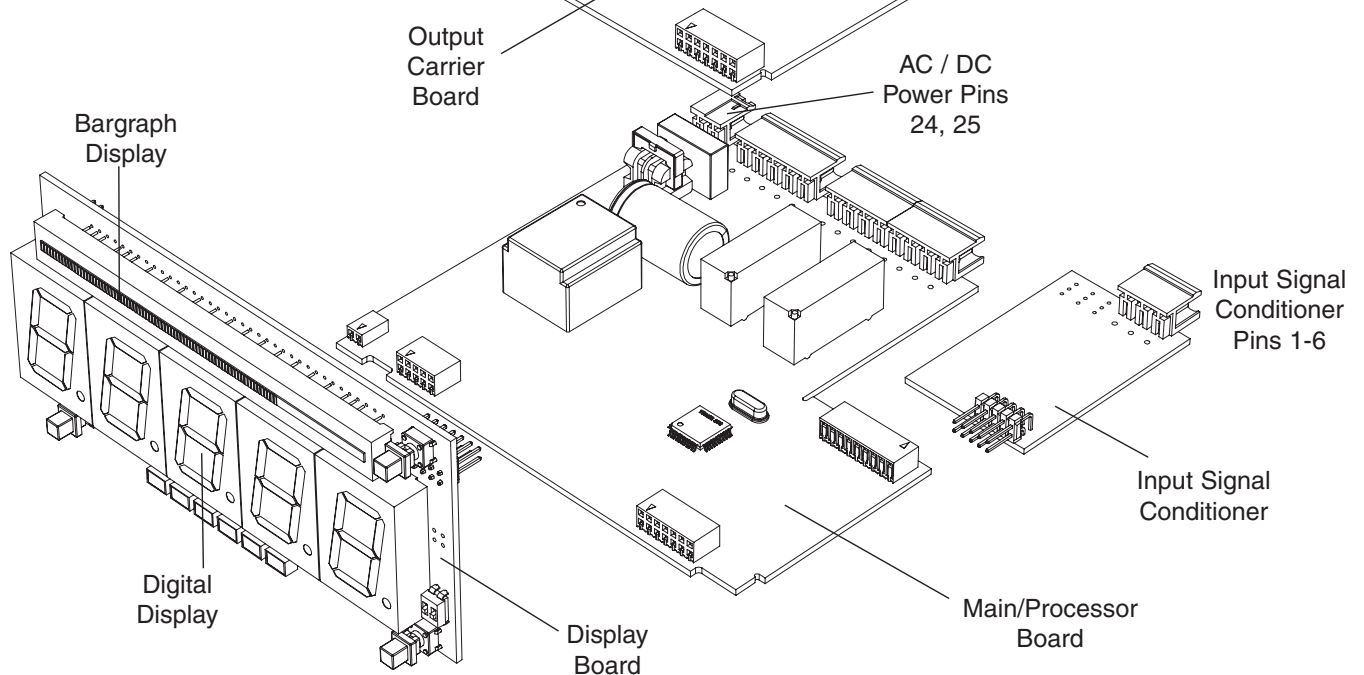

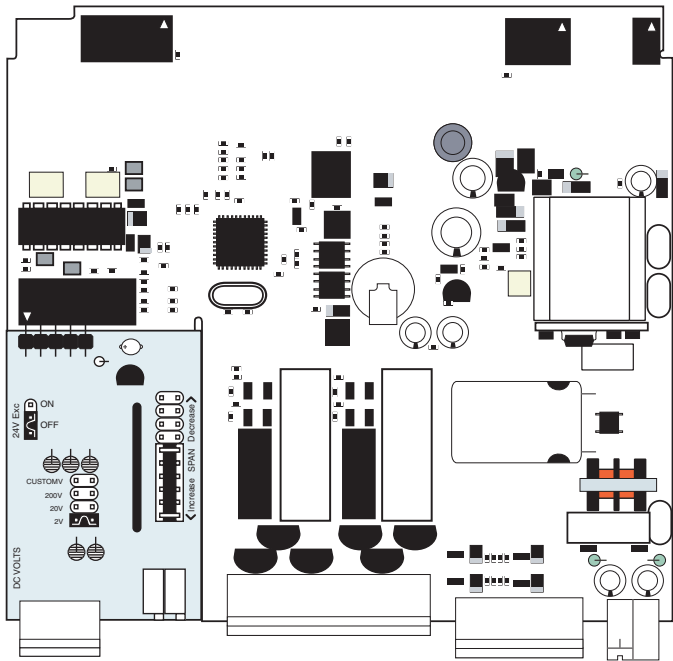

Main PCB*

*Shown with optional Input Signal Conditioning Module (Ordered Separately)

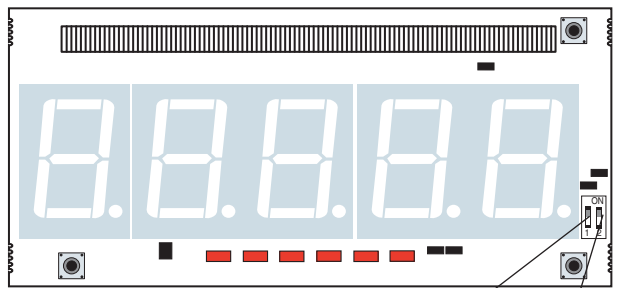

Display Board

SETPOINT LOCKOUT Switch
PROGRAM LOCKOUT Switch

Analog Output Module PCB

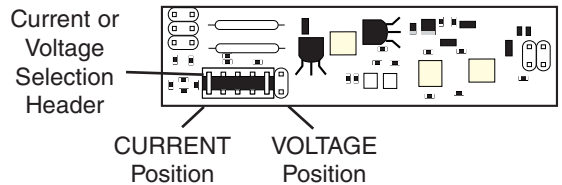

Available in Single (0~4-20mA or 0-10V) or Dual (0-10V & 0-10V)

Standard Serial Output Modules RS-232 or RS-485

Note:

Externally mounted Ethernet compatible communication output modules are available that connect directly to the standard (RS-232 / RS-485) serial module outputs.

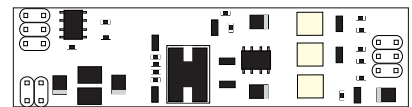

RS-485 Output Module PCB



RS-232 Output Module PCB

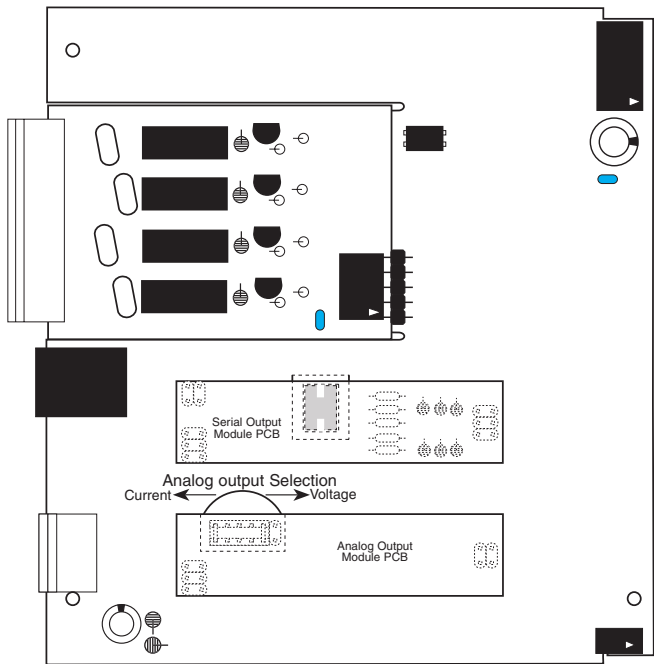

Standard Output Carrier Board*

*Shown with optional Analog Output Module, optional Relay Output Module and a Serial Output Module (RS-232, RS-485 or No Serial Output)

Opto Isolated I/O Modules Connect to External DIN Rail Mounting Breakout Box

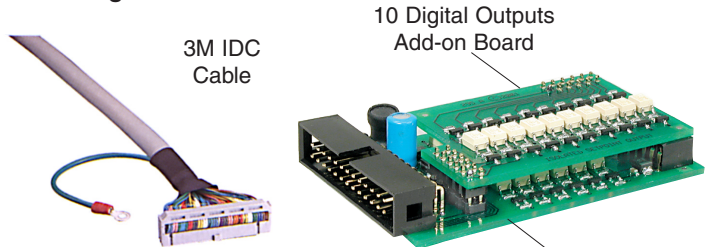

DIN Rail Mounting Breakout Box with Screw Terminal Blocks

Standard 6 Digital Inputs/6 Digital Outputs

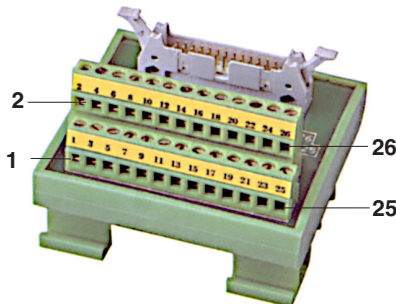

DIN Rail Relay Module



I-SERIES INPUT SIGNAL CONDITIONING MODULES

Over 120 plug-in signal conditioning modules are available to suit almost any input signal, control, or data output. Modules can be easily inserted through the rear of the meter without disassembly of the case or removal from the panel. Many modules are exclusively designed for the Tiger 320 Series, and some can also be used with the Leopard and Lynx Family panel meters and bargraphs.

Function	Module Page	Function	Module Page	Function	Module Page
AC		• Process Loop, 4 to 20mA w/24V DC Exc. and AutoCal	IP06...60	SMART MODULES	
• AC Amps, Scaled RMS	IA04...58	• Process Loop, 4 to 20mA with 24V DC Exc.	IP02...60	• Dual Smart Pressure/Load Cell, 16 bit	ISS5*...60
• AC Amps, Scaled RMS	IA05...58	• Quad 4 to 20mA	IP01...60	• Dual Smart Pressure/Load Cell, 16 bit	ISS6*...60
• AC Amps, True RMS	IA09...58	• Smart Dual Input, Load Cell and Process (4-20mA)	ISS9...61	• Smart DC Volts, 16 bit, 1 to 800 Hz update rates	ISD1*...61
• AC Amps, True RMS	IA11...58	• Triple 4 to 20mA	ITP1...62	• Smart DC Volts, 16 bit, 1 to 960 Hz update rates	ISD2*...61
• AC Millamps, Scaled RMS	IA03...58	• Triple - T/C, 4 to 20mA and 4 to 20mA	ITR8...62	• Smart DC Volts, 16 bit, 1 to 800 Hz w/dual SSRs	ISD3*...61
• AC Millamps, True RMS	IA08...58	• Triple - T/C, 4 to 20mA and Counter	ITTF...62	• Smart DC Volts, 16 bit, 1 to 960 Hz w/dual SSRs	ISD4*...61
• AC Millivolts, Scaled RMS	IA10...58	• Triple - T/C, 4 to 20mA and DC mV	ITTA...62	• Smart DC Volts, High Res & Acc, 24 bit 1-400Hz	ISD5*...61
• AC Millivolts, True RMS	IA12...58	• Triple - T/C, 4 to 20mA and DC Volts	ITTB...62	• Smart DC Volts, High Res & Acc, 24 bit 1-480Hz	ISD6*...61
• AC Volts, Scaled RMS	IA01...58	• Triple - T/C, T/C and 4 to 20mA	ITTA...62	• Smart DC V, High Res & Acc, 1-400Hz w/dual SSRs	ISD7*...61
• AC Volts, Scaled RMS	IA02...58			• Smart DC V, High Res & Acc, 1-480Hz w/dual SSRs	ISD8*...61
• AC Volts, True RMS	IA06...58	FREQUENCY / RPM		• Smart Dual 3-wire Potentiometer (50 Hz)	ISR3*...61
• AC Volts, True RMS	IA07...58	• Dual - Strain Gage and Frequency	IDS3...59	• Smart Dual 3-wire Potentiometer (60 Hz)	ISR4*...61
		• Dual Frequency	IDF2...59	• Smart Dual Photo Diode Input	ISSE...61
COUNTER		• Line Frequency	IF06...59	• Smart Single 3-wire Potentiometer (50 Hz)	ISR1*...61
• Dual - UP/DOWN Counter	IDC1...59	• Triple RTD / RTD / Frequency	ITTE...62	• Smart Single 3-wire Potentiometer (60 Hz)	ISR2*...61
• Quadrature Counter	IC02...58	• Triple - T/C, Volts and Frequency	ITTG...62	• Smart Dual Input, Load Cell and Process (4-20mA)	ISS9...61
• Quadrature Counter w/dual SSRs	IC03...58	• Universal Freq / RPM / Up Down Counter	IF10...59	• Smart Dual Input, Load Cell and RTD	ISSB...62
• Smart Triple Input, Pressure Direct & Dual Counter	ISP1...61			• Smart Dual Input DC Volts, 16 bit, 1-20Hz update	ISDA*...61
• Triple - T/C, 4 to 20mA and Counter	ITTF...62			• Smart Dual Input DC Volts, 16 bit, 1-20Hz update	ISDB*...61
• Universal Freq / RPM / Up Down Counter	IF10...59			• Smart Dual LVDT (60 Hz)	ISL1*...61
				• Smart Dual LVDT (50 Hz)	ISL2*...61
DC				• Smart Dual LVDT (60 Hz)	ISL2*...61
• DC Amps	ID04...58	OXIDATION REDUCTION POTENTIAL		• Smart Dual Photo Diode Input	ISSE...61
• DC Amps	ID09...59	• Oxidation Reduction Potential (ORP)	IOR1...60	• Smart Dual RTD (50 Hz)	IST5*...62
• DC Millamps	ID03...58			• Smart Dual RTD (60 Hz)	IST6*...62
• DC Millamps with Offset and 24V Exc.	ID07...58	pH		• Smart Magnetostrictive Input	ISM1...61
• DC Millivolts	ID02...58	• pH	IHO1...60	• Smart Pressure/Load Cell, Standard Res 16 bit	ISS1*...61
• DC Volts	ID01...58	• pH with Automatic Temperature Compensation	IHO2...60	• Smart Pressure/Load Cell, Standard Res 16 bit	ISS2*...61
• DC Volts with External Decimal Select	ID06...58	POTENTIOMETER		• Smart Pressure/Load Cell, High Res & Acc 24 bit	ISS3*...61
• DC Volts with External LIN Table Select	ID08...58	• Linear Potentiometer 1K Ω min	IR03...61	• Smart Pressure/Load Cell, High Res & Acc 24 bit	ISS4*...61
• DC Volts with Offset and 24V Exc.	ID05...58	• Smart Dual 3-wire Potentiometer (50 Hz)	ISR3*...61	• Smart Quad Potentiometer/Resistance	ISSA...61
• DC-Watts, 10V/50mV DC	IW03...62	• Smart Dual 3-wire Potentiometer (60 Hz)	ISR4*...61	• Smart Quad Pressure/Load Cell (50 Hz)	ISS7*...61
• Dual - 3-wire RTD and DC V	IDT3...59	• Smart Quad Potentiometer/Resistance	ISSA...61	• Smart Quad Pressure/Load Cell (60 Hz)	ISS8*...61
• Dual DC Millamps	IDD3...59	• Smart Single 3-wire Potentiometer (50 Hz)	ISR1*...61	• Smart Quad Thermocouple (50 Hz)	IST3*...62
• Dual DC Millivolts	IDD2...59	• Smart Single 3-wire Potentiometer (60 Hz)	ISR2*...61	• Smart Quad Thermocouple (60 Hz)	IST4*...62
• Dual - DC mV and 4 to 20mA	IDD6...59			• Thermocouple	IT01...62
• Dual - DC V and 4 to 20mA	IDD5...59	PRESSURE		• Triple - T/C, 4 to 20mA and 4 to 20mA	ITR8...62
• Dual - DC V and DC mV	IDD4...59	• Direct Pressure with 2 Digital Inputs	IGYX...60	• Triple - T/C, 4 to 20mA and Counter	ITTF...62
• Dual DC Volts	IDD1...59	• Dual Direct Pressure (Absolute or Differential/Gage)	IGYV...60	• Triple - T/C, 4 to 20mA and DC mV	ITTA...62
• Dual - Thermocouple and DC mV	IDT5...59	• Dual Pressure Input	IDS2...59	• Triple - T/C, 4 to 20mA and DC Volts	ITTB...62
• Dual - Thermocouple and DC V	IDT4...59	• Dual Smart Pressure/Load Cell, 16 bit	ISS5*...60	• Triple - T/C, DC mV and DC mV	ITF6...62
• Process Input with Offset and 24V Exc (1-5VDC)	IP03...60	• Dual Smart Pressure/Load Cell, 16 bit	ISS6*...60	• Triple - T/C, DC Volts and DC mV	ITF9...62
• Process - 3 Digital Inputs	IP10...60	• Pressure/Load Cell Ext Exc, High Impedance	IS07...61	• Triple - T/C, DC Volts and DC Volts	ITF7...62
• Quad DC mV	IQD2...60	• Pressure/Load Cell Ext Exc, 4/6-wire	IS04...61	• Triple - T/C, T/C and 4 to 20mA	ITTA...62
• Quad DC Volts	IQD1...60	• Pressure/Load Cell Ext Exc, 20/20mV/V, 4-wire	IS06...61	• Triple - T/C, T/C and DC mV	ITF5...62
• Smart DC Volts, 16 bit, 1 to 800 Hz update rates	ISD1*...61	• Pressure/Load Cell with AutoCal, 4-wire	IS03...61	• Triple - T/C, T/C and DC V	ITF3...62
• Smart DC Volts, 16 bit, 1 to 960 Hz update rates	ISD2*...61	• Pressure/Load Cell, 4/6-wire	IS02...61	• Triple - T/C, Volts and Frequency	ITFG...62
• Smart DC Volts, 16 bit, 1 to 800 Hz w/dual SSRs	ISD3*...61	• Pressure/Load Cell, 20/2mV/V, 5/10V Exc 4-wire	IS05...61	• Triple Thermocouple	ITT1...62
• Smart DC Volts, 16 bit, 1 to 960 Hz w/dual SSRs	ISD4*...61	• Smart Pressure/Load Cell, Standard Res 16 bit	ISS1*...61		
• Smart DC Volts, High Res & Acc, 24 bit 1-400Hz	ISD5*...61	• Smart Pressure/Load Cell, Standard Res 16 bit	ISS2*...61	TRIPLE INPUTS	
• Smart DC Volts, High Res & Acc, 24 bit 1-480Hz	ISD6*...61	• Smart Pressure/Load Cell, High Res & Acc 24 bit	ISS3*...61	• Smart Triple Input, Load Cell and Two Digital Inputs	ISSC*...61
• Smart DC V, High Res & Acc, 1-400Hz w/dual SSRs	ISD7*...61	• Smart Pressure/Load Cell, High Res & Acc 24 bit	ISS4*...61	• Smart Triple Input, Load Cell and Two Digital Inputs	ISSD*...61
• Smart DC V, High Res & Acc, 1-480Hz w/dual SSRs	ISD8*...61	• Smart Quad Pressure/Load Cell (50 Hz)	ISS7*...61	• Smart Triple Input, Load Cell and Two Digital Inputs	ISSC...62
• Smart Dual Input DC Volts, 16 bit, 1-20Hz update	ISDA*...61	• Smart Quad Pressure/Load Cell (60 Hz)	ISS8*...61	• Smart Triple Input, Pressure Direct & Dual Counter	ISP1...61
• Smart Dual Input DC Volts, 16 bit, 1-20Hz update	ISDB*...61	• Smart Triple Input, Pressure Direct & Dual Counter	ISP1...61	• Triple 4 to 20mA	ITP1...62
• Triple DC mV, 50mV DC	ITD2...62	• Universal Direct Pressure	IGY2...60	• Triple - DC mV, 2V DC	IDT2...62
• Triple DC Volts, 2V DC	ITD1...62	PROCESS INPUT		• Triple - DC Volts, 2V DC	IDT1...62
• Triple - T/C, DC mV and DC mV	ITF6...62	• Process Input with Offset and 24V Exc (1-5VDC)	IP03...60	• Triple RTD Platinum 100 Ω RTD 4-wire connection	ITTC...62
• Triple - T/C, DC Volts and DC mV	ITF9...62	PROCESS LOOP		• Triple RTD Platinum 100 Ω RTD 2-wire connection	ITT2...62
• Triple - T/C, DC Volts and DC Volts	ITF7...62	• Dual Process Loop	IDP1...59	• Triple - RTD / RTD / Frequency	ITTE...62
• Triple - T/C, T/C and DC mV	ITF5...62	• Process Loop, 4 to 20mA	IP01...60	• Triple - T/C, 4 to 20mA and 4 to 20mA	ITR8...62
• Triple - T/C, T/C and DC V	ITF3...62	• Process Loop, 4 to 20mA (0-100.00) w/ Ext. Lin Table	IP09...60	• Triple - T/C, 4 to 20mA and Counter	ITTF...62
• Universal Process Input	IP07...60	• Process Loop, 4 to 20mA w/24V DC Exc. and AutoCal	IP06...60	• Triple - T/C, 4 to 20mA and DC mV	ITTA...62
• Universal Process Input with AutoCal	IP08...60	• Process Loop, 4 to 20mA with 24V DC Exc.	IP02...60	• Triple - T/C, DC mV and DC mV	ITF6...62
				• Triple - T/C, DC Volts and DC Volts	ITF9...62
DUAL INPUTS				• Triple - T/C, T/C and 4 to 20mA	ITTA...62
• Dual - 3-wire RTD and DC V	IDT3...59	QUAD INPUTS		• Triple - T/C, T/C and DC mV	ITF5...62
• Dual - 3-wire RTD and 4 to 20mA	IDP2...58	• Quad 4 to 20mA	IQP1...60	• Triple - T/C, T/C and DC V	ITF3...62
• Dual DC Millamps	IDD3...59	• Quad DC mV	IQD2...60	• Triple - T/C, Volts and Frequency	ITFG...62
• Dual DC Millivolts	IDD2...59	• Quad DC Volts	IQD1...60	• Triple Thermocouple	ITT1...62
• Dual - DC mV and 4 to 20mA	IDD6...59	• Quad RTD Platinum 2 wire connection	IQT2...60		
• Dual - DC V and 4 to 20mA	IDD5...59	• Quad RTD Platinum 4 wire connection	IQT4...60		
• Dual - DC V and DC mV	IDD4...59	• Quad - Thermocouple / DC V / DC V / Frequency	IQT5...60		
• Dual DC Volts	IDD1...59	• Smart Quad Potentiometer/Resistance	ISSA...61		
• Dual Direct Pressure (Absolute or Differential/Gage)	IGYV...60	• Smart Quad Pressure/Load Cell (50 Hz)	ISS7*...61		
• Dual Frequency	IDF2...59	• Smart Quad Pressure/Load Cell (60 Hz)	ISS8*...61		
• Dual Pressure Input	IDS2...59	• Smart Quad Thermocouple (50 Hz)	IST3*...62		
• Dual Process Loop	IDP1...59	• Smart Quad Thermocouple (60 Hz)	IST4*...62		
• Dual Resistance Input	IDR1...59	RESISTANCE			
• Dual RTD Input	IDT2...59	• Dual Resistance Input	IDR1...59		
• Dual Smart Pressure/Load Cell, 16 bit	ISS5*...60	• Resistance, 2/3/4-Wire	IR01...60		
• Dual Smart Pressure/Load Cell, 16 bit	ISS6*...60	• Smart Quad Potentiometer/Resistance	ISSA...61		
• Dual - Strain Gage Input	ISD1...59	RTD			
• Dual - Strain Gage and Frequency	IDS3...59	• Dual - 3-wire RTD and DC V	IDT3...59		
• Dual Thermocouple	IDT1...59	• Dual - 3-Wire RTD and 4 to 20mA	IDP2...58		
• Dual - Thermocouple and 4 to 20mA	IDP3...59	• Dual RTD Input	IDT2...59		
• Dual - Thermocouple and DC mV	IDT5...59	• Quad RTD Platinum 2 wire connection	IQT2...60		
• Dual - Thermocouple and DC V	IDT4...59	• Quad RTD Platinum 4 wire connection	IQT4...60		
• Dual - Thermocouple and Load Cell	IDT6...59	• RTD, 100 Ω Pt. 2/3/4-wire	IT02...62		
• Dual UP/DOWN Counter	IDC1...59	• RTD, 100 Ω Pt. 2/3/4-wire (-200 to 800°C)	IT03...62		
• Smart Dual 3-wire Potentiometer	ISR3...61	• RTD, 100 Ω Pt. 2/3/4-wire (-200 to 1470°F)	IT04...62		
• Smart Dual Input, Load Cell and Process (4-20mA)	ISS9...61	• RTD, 100 Ω Pt. 2/3/4-wire (-199.9 to 199.9°C)	IT05...62		
• Smart Dual Input, Load Cell and RTD	ISSB...62	• RTD, 100 Ω Pt. 2/3/4-wire (-199.9 to 199.9°F)	IT14...62		
• Smart Dual Input DC Volts, 16 bit, 1-20Hz update	ISDA*...61	• RTD, 10 Ω Copper 2/3/4-wire	IT13...62		
• Smart Dual Input DC Volts, 16 bit, 1-20Hz update	ISDB*...61	• RTD, 120 Ω Nickel 2/3/4-wire	IT12...62		
• Smart Dual LVDT (60 Hz)	ISL1*...61	• Smart Dual Input, Load Cell and RTD	ISSB...62		
• Smart Dual LVDT (50 Hz)	ISL2*...61	• Smart Dual RTD (50 Hz)	IST5*...62		
• Smart Dual Photo Diode Input	ISSE...61	• Smart Dual RTD (60 Hz)	IST6*...62		
• Smart Dual RTD (50 Hz)	IST5*...62	• Smart 6 Input - 3 RTD, 2 Process, 1 Digital Input	IST1*...62		
• Smart Dual RTD (60 Hz)	IST6*...62	• Smart 6 Input - 3 RTD, 2 Process, 1 Digital Input	IST2*...62		
		• Triple RTD Platinum 100 Ω RTD 4-wire connection	ITTC...62		
		• Triple RTD Platinum 100 Ω RTD 2-wire connection	ITT2...62		
		• Triple - RTD / RTD / Frequency	ITTE...62		
		SINGLE PHASE POWER			
		• Single Phase Power, 300V/1A	IW01...62		
		• Single Phase Power, 300V/5A	IW02...62		
		• Single Phase Power, 600V/1A	IW04...62		
		• Single Phase Power, 600V/5A	IW05...62		

*Optimized for 50 Hz rejection.
**Optimized for 60 Hz rejection.

I-Series Input Signal Conditioning Modules continued

Many additional input modules are available and others are constantly being developed. Check with your local distributor or see Texmate's web site at: www.texmate.com for updated information. Pre calibrated **I-Series Input Modules**, that have span or zero potentiometers, **can be interchanged between any I-Series compatible meter**, without recalibration, because all of the analog scaling and reference circuitry is self-contained within the module. Where appropriate, all the standard ranges are designed to be header selectable by the user, and our unique **SPAN ADJUST** Header facilitates **scaling to almost any required engineering unit**. See Input Module Component Glossary for more information.

Unless otherwise specified, we will ship all modules pre calibrated with factory preselected ranges and/or scaling as shown in **BOLD** type. Other pre calibrated standard ranges or custom ranges may be ordered. Factory installed custom scaling and other custom options are also available.

Symbols Indicate Module Compatibility Within Meter Families		
TIGER Family	LEOPARD Family	LYNX Family
TIGER Family	LEOPARD Family	LYNX Family
TIGER Family	LEOPARD Family	LYNX Family
ALL MODELS	SOME MODELS	MODEL SPECIFIC



*A module code shown below a compatibility symbol indicates another module is available, similar in function, which may be more suited for use with that family.



**Modules which are compatible are listed below the Model Specific Symbol.



Indicates a SMART MODULE. Smart Modules incorporate their own microprocessor and A/D converter. They communicate digitally with the Tiger 320 Operating System. Some also have their own SSR outputs.

IA01: AC Volts Scaled RMS, 200/600V AC

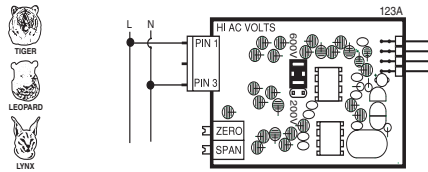

IA08: AC Milliamps True RMS, 2/20/200mA AC

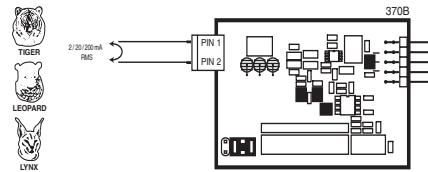

ID02: DC Millivolts, 20/50/100/200mV DC w/24V DC Exc

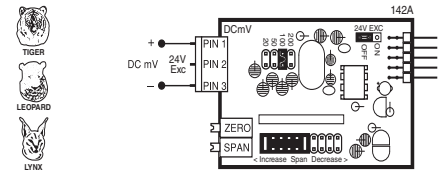

IA02: AC Volts Scaled RMS, 200mV/2V/20V AC

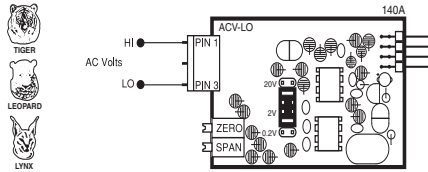

IA09: AC Amps True RMS, 1 Amp AC

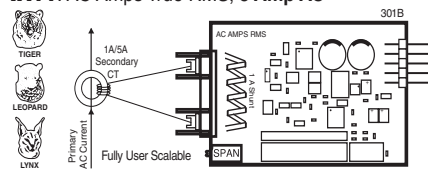

ID03: DC Milliamps, 2/20/200mA DC w/24V DC Exc

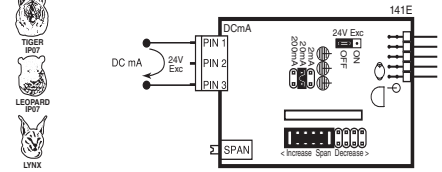

IA03: AC Milliamps Scaled RMS, 2/20/200mA AC

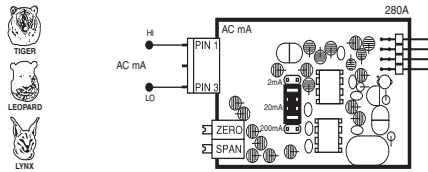

IA10: AC Millivolts, Scaled RMS, 100mV AC

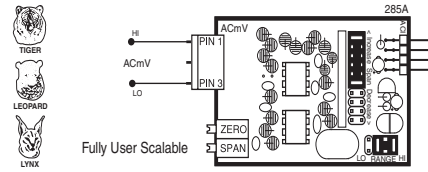

ID04: DC Amps, 5A DC

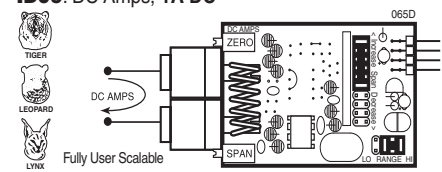

IA04: AC Amps Scaled RMS, 1 Amp AC

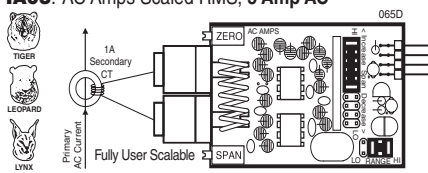

IA12: AC Millivolt RMS Sigma Delta

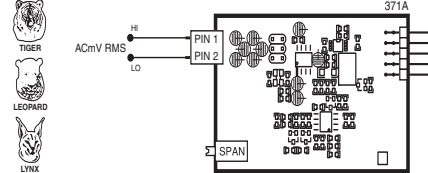

ID05: DC Volts 2/20/200/Custom V DC with Offset and 24V Exc.

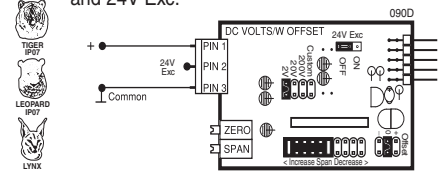

IA06: AC Volts True RMS, 300/600V AC

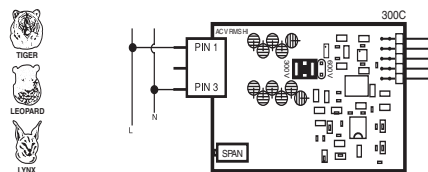

IC02: Quadrature Counter

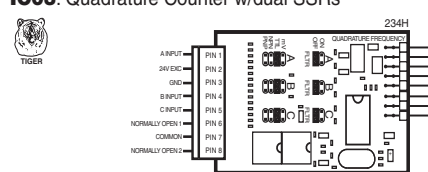

ID06: DC Volts 2/20/200/Custom V DC with External Decimal Select

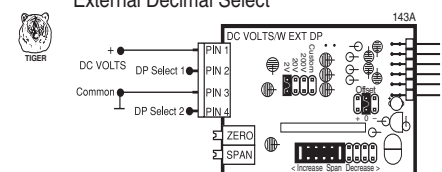

IA07: AC Volts True RMS, 200mV/2V/20V AC

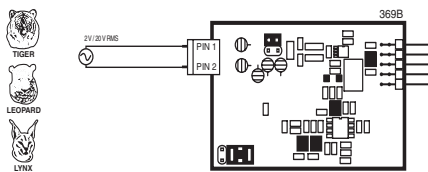

ID01: DC Volts, 2/20/200V/Custom w/24V DC Exc

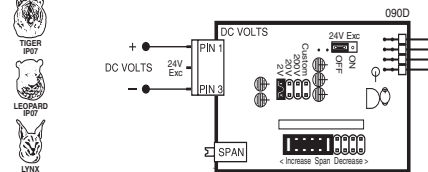

ID07: DC Milliamps, 2/20/200mA DC with Offset and 24V Exc

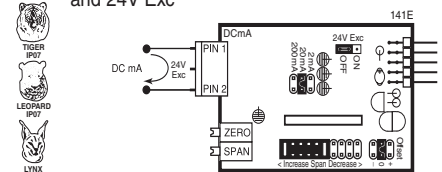

I-Series Input Signal Conditioning Modules continued

ID08: DC Volts, 2/20/200/Custom V DC with External LIN Table Select

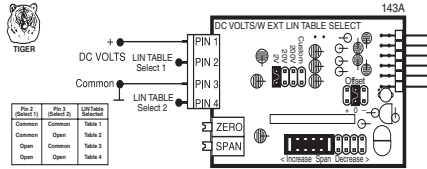

IDC1: Dual UP/DOWN Counter

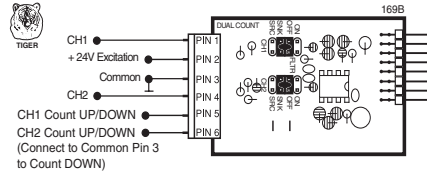

IDD1: Dual DC Volts, 2V DC

IDD2: Dual DC Millivolts, 50mV DC

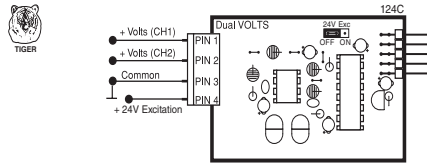

IDD3: Dual DC Milliamps, 2mA DC

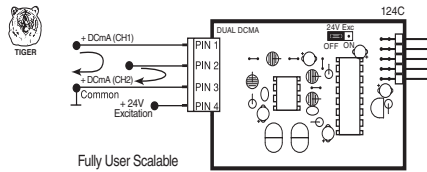

IDD4: Dual Input, DCV and DCmV 2V/50mV DC

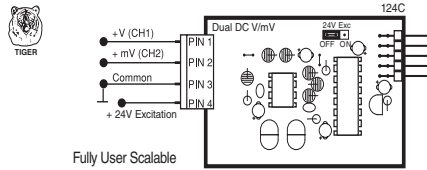

IDD5: Dual Input, DCV and 4 to 20mA 2V/4 to 20mA DC

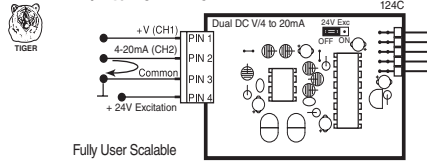

IDD6: Dual Input, DC mV and 4 to 20mA 50mV/4 to 20mA DC

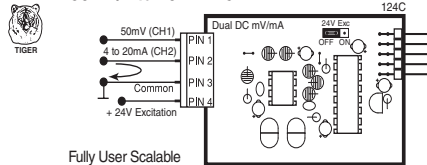

IDF2: Dual Frequency

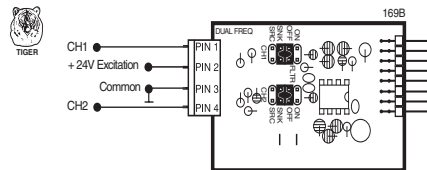

IDP1: Dual Process Loop, 4-20mA

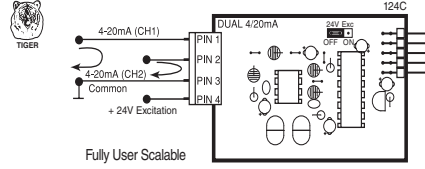

IDP2: Dual Input, 3-wire RTD and 4-20mA

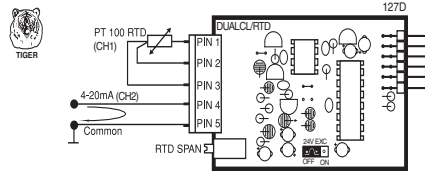

IDP3: Dual Input - Thermocouple (J/K/R/S/T/B/N) and 4 to 20mA

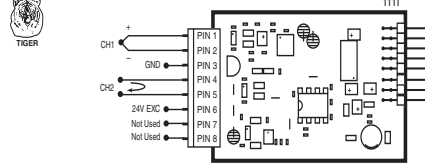

IDR1: Dual Resistance Input, 0.2/2/20KΩ

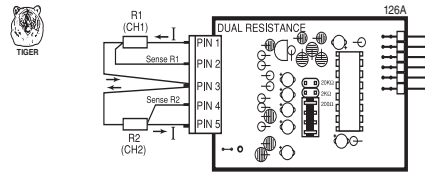

IDS1: Dual Strain Gage Input, 4 wire 2mV/V, 20mV/V

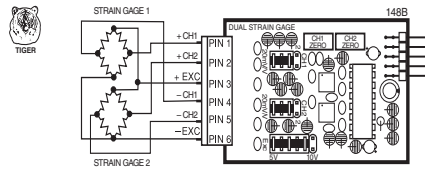

IDS2: Dual Pressure Input, 4 wire 2mV/V, 20mV/V

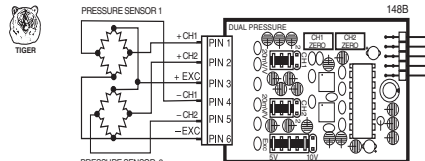

IDS3: Dual Input, Strain Gage and Frequency

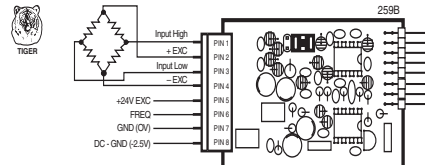

IDT1: Dual Thermocouple (J/K/R/S/T/B/N)

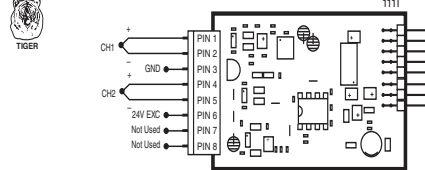

IDT2: Dual RTD Input, 2/3-wire, 100Ω Pt

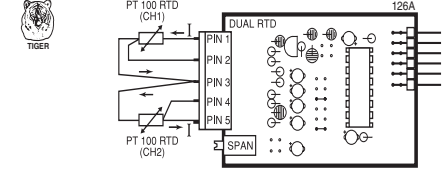

IDT3: Dual Input, 3-wire RTD and DCV

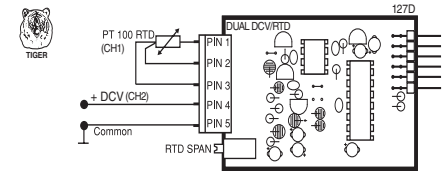

IDT4: Dual Input - Thermocouple (J/K/R/S/T/B/N) and 2VDC Input

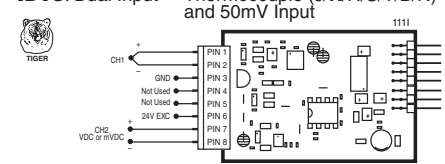

IDT6: Dual Input - Thermocouple and Load Cell

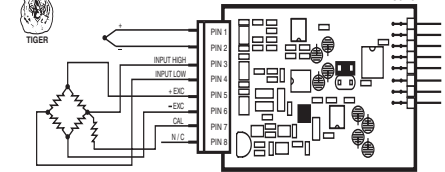

IF06: Line Frequency

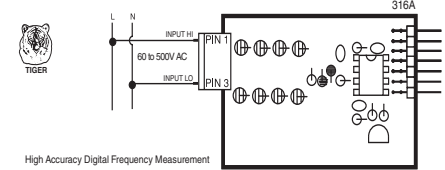

IF10: Univ. Freq. / RPM / UP DOWN Counter

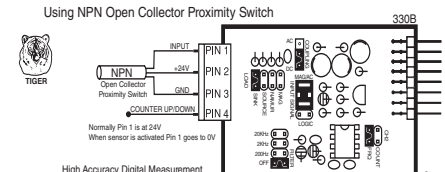

TTL Input Connected to IF10

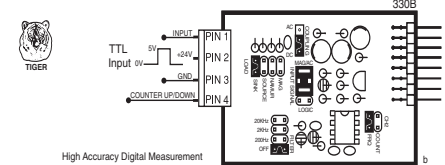

Tach Generator Connected to IF10

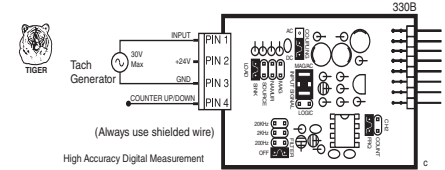

I-Series Input Signal Conditioning Modules continued

NAMUR Sensor Connected to IF10

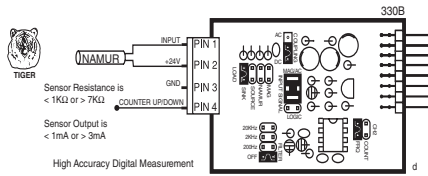

PNP Open Collector Proximity Switch Connected to IF10

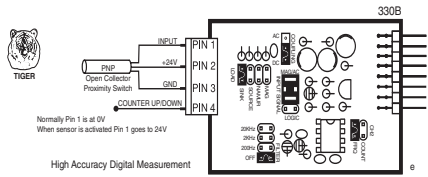

Switch or Dry Contact Connected to IF10

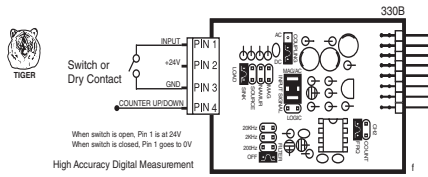

Magnetic Pickup Connected to IF10

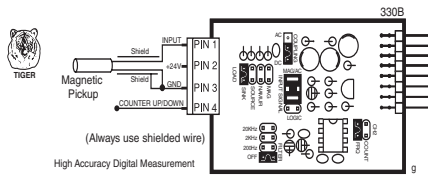

IGYX: Direct Pressure (Absolute or Differential/Gage) with 2 Digital Inputs. See below for ordering code options

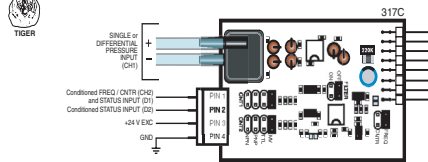

IGYY: Dual Direct Pressure (Absolute or Differential/Gage) see below for ordering code options

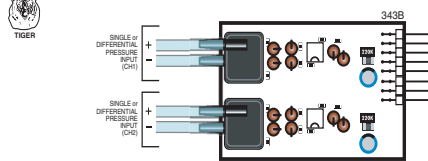

IGYZ: Universal Direct Pressure (Absolute or Differential/Gage) See below for ordering code options

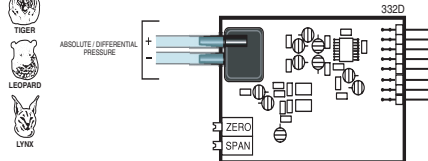

Direct Pressure (IGYX, IGYZ & IGYZ) Ordering Code Options

Sensor Range	CH1 Order Code	CH2 Order Code
1 psi Absolute	A	A
1 psi Differential	B	B
5 psi Absolute	C	C
5 psi Differential	D	D
15 psi Absolute	E	E
15 psi Differential	F	F
30 psi Absolute	G	G
30 psi Differential	H	H
100 psi Absolute	J	J

For Single Channel IGYX with two digital inputs, the last digit of order code is always X.
For Universal Direct Pressure IGYZ, the last digit of order code is always Z.

IHO1: pH IHO2: pH with Automatic Temperature Compensation

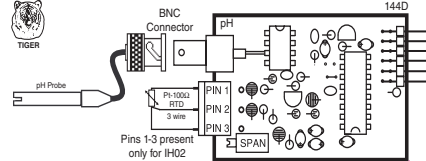

IOR1: ORP (Oxidation Reduction Potential)

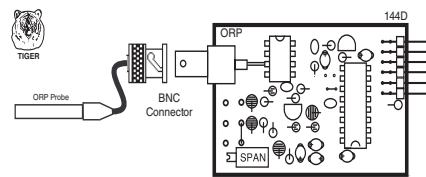

IPO1: Process Loop, 4-20mA IPO2: Process Loop, 4-20mA with 24VDC EXC

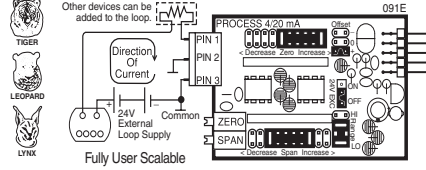

IPO3: Process Input, 1-5V DC with Offset, 24V Exc

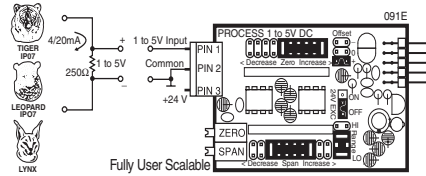

IPO6: Process Loop, 4-20mA w/24VDC Exc and Autocal

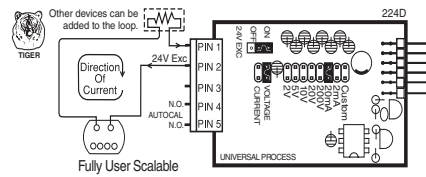

IPO7: Universal Process Input 2V/5V/10V/20V/200V/2mA/20mA/Custom

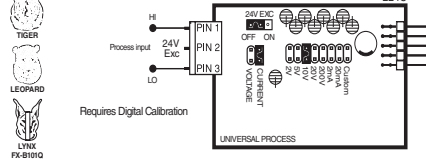

IPO8: Universal Process Input with Autocal 2V/5V/10V/20V/200V/2mA/20mA/Custom

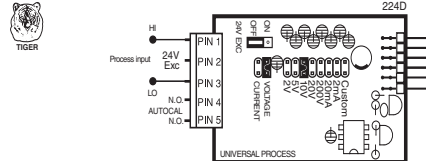

IPO9: 4-20mA with External LIN Table Select

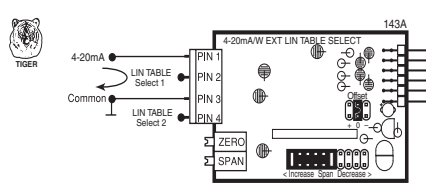

IP10: Process + 3 Digital Inputs

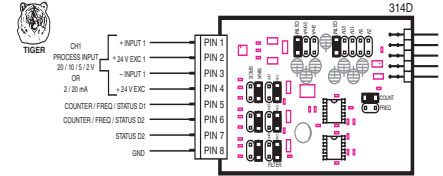

IPT1: Prototype Board for Custom Design

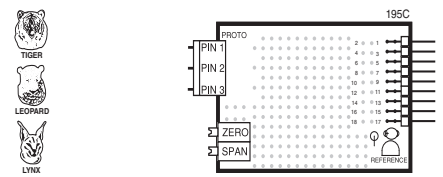

IQD1: Quad DC Volts, 2V DC IQD2: Quad DC mV, 50mV DC

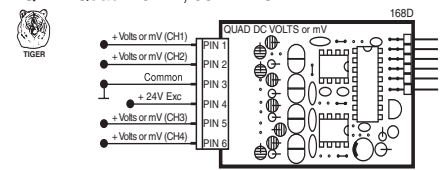

IQP1: Quad 4 to 20mA

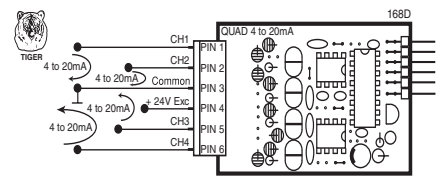

IQT2: Quad RTD Platinum 100Ω RTD 2 Wire Connection

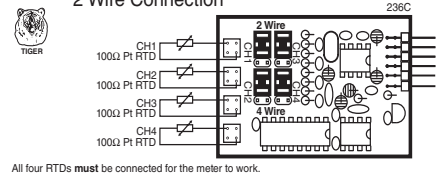

IQT4: Quad RTD Platinum 100Ω RTD 4 Wire Connection

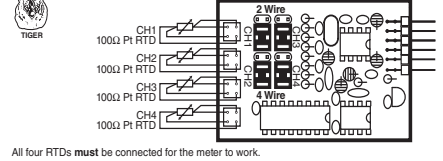

IQT5: Quad RTD / V / V / FREQ

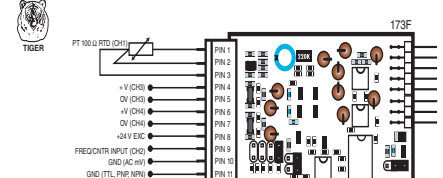

IRO1: Resistance, 2/3/4-Wire, 200Ω/2KΩ/20KΩ

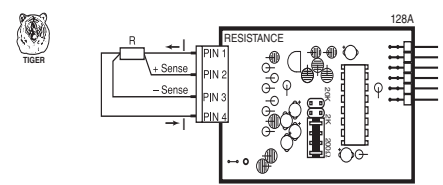

I-Series Input Signal Conditioning Modules continued

IR03: Linear Potentiometer 1KΩ min

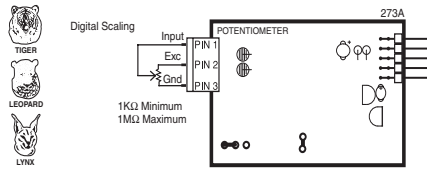

IS01: Strain Gage 5/10VDC Exc., 20/2mV/V, 4/6-wire

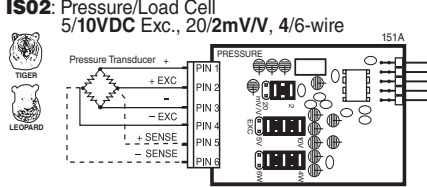

IS03: Pressure/Load Cell with AutoCal 5/10VDC Exc., 20/2mV/V, 4-wire

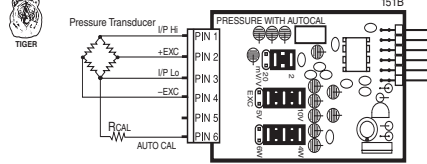

IS04: Pressure/Load Cell Ext Exc., 20/2mV/V, 4/6-wire

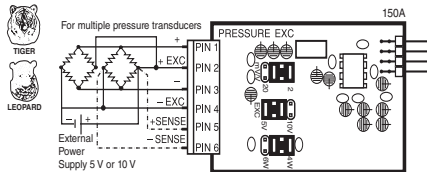

IS05: Pressure/Load Cell 20/2mV/V, 5/10V Exc 4-wire

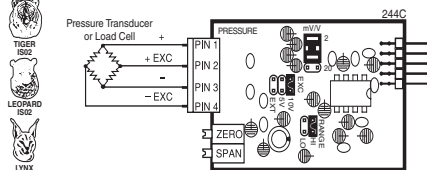

IS06: Pressure/Load Cell Ext Exc., 20/2mV/V, 4-wire

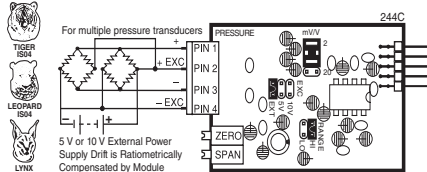

IS07: Pressure/Load Cell Ext Exc. High Impedance, 20/2mV/V, 4/6-wire

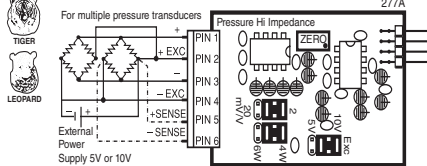

ISD1: Smart DC Volts. 16 bit. Optimized for 50 Hz rejection.

ISD2: Smart DC Volts. 16 bit. Optimized for 60 Hz rejection.

ISD3: Smart DC Volts. 16 bit. 50 Hz rejection w/dual SSRs.

ISD4: Smart DC Volts. 16 bit. 60 Hz rejection w/dual SSRs.

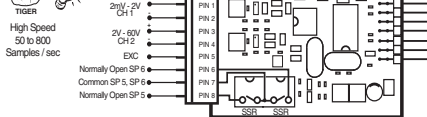

ISD5: Smart DC Volts. 24 Bit. 50 Hz rejection.
ISD6: Smart DC Volts. 24 Bit. 60 Hz rejection.
ISD7: Smart DC Volts. 24 Bit. 50 Hz w/dual SSRs.
ISD8: Smart DC Volts. 24 Bit. 60 Hz w/dual SSRs.

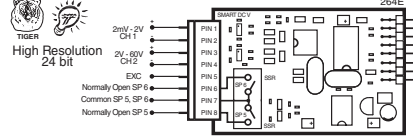

ISD9: Smart Voltage and Resistance Input

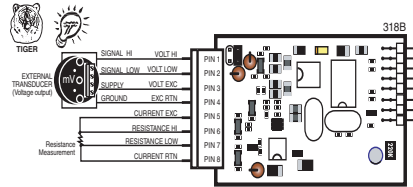

ISDA: Smart Dual DC Volts. 16 bit. 50 Hz rejection.

ISDB: Smart Dual DC Volts. 16 bit. 60 Hz rejection.

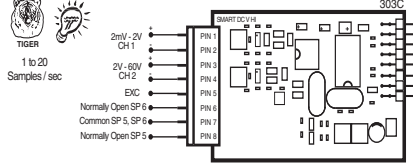

ISL1: Smart Dual LVDT. 50 Hz

ISL2: Smart Dual LVDT. 60 Hz

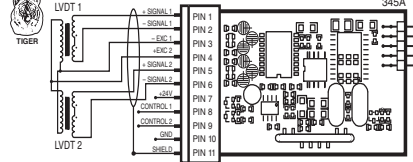

ISM1: Smart Magnetostrictive Input

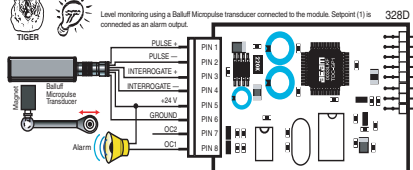

ISP1: Smart Triple Input, Pressure Direct and Dual Counter (Frequency/Counter)

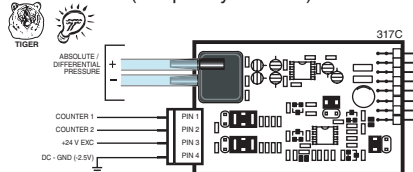

ISR1: Smart Single 3-Wire Potentiometer. 24 bit. 50 Hz

ISR2: Smart Single 3-Wire Potentiometer. 24 bit. 60 Hz

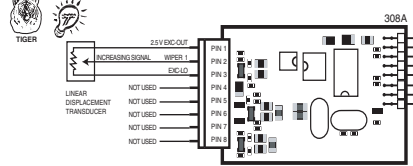

ISR3: Smart Triple 3-Wire Potentiometer. 16 bit. 50 Hz

ISR4: Smart Dual 3-Wire Potentiometer. 16 bit. 60 Hz

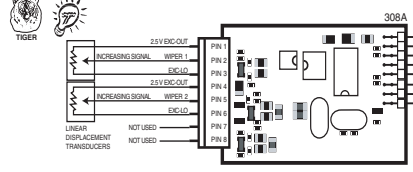

ISS1: Smart Pressure/Load Cell. 16 bit (50 Hz rejection)
ISS2: Smart Pressure/Load Cell. 16 bit (60 Hz rejection)
ISS3: Smart Pressure/Load Cell. 24 bit (50 Hz rejection)
ISS4: Smart Pressure/Load Cell. 24 bit (60 Hz rejection)

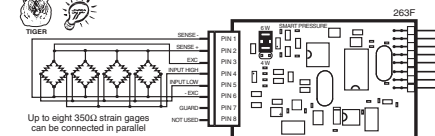

ISS5: Dual Smart Pressure. 16 bit. Optimized for 50 Hz rejection.

ISS6: Dual Smart Pressure. 16 bit. Optimized for 60 Hz rejection.

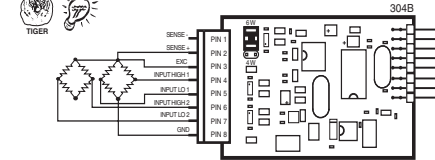

ISS7: Smart Quad Pressure/Load Cell. 16 bit. 50 Hz

ISS8: Smart Quad Pressure/Load Cell. 16 bit. 60 Hz

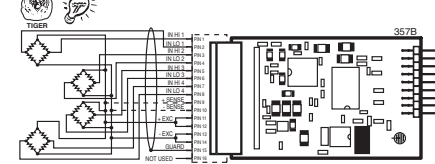

ISS9: Smart Dual Input, LC and Process (4-20mA)

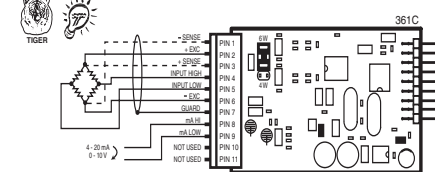

ISSA: Smart Quad Potentiometer/Resistance

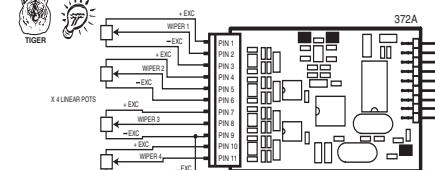

ISSB: Smart Dual Input, Load Cell and RTD

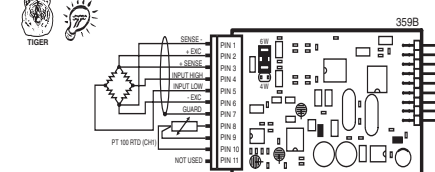

ISSC: Smart Triple Input, 16 bit, Load Cell and two Digital Inputs (Frequency/Counter) (Optimized for 50 Hz)

ISSD: Smart Triple Input, 16 bit, Load Cell and two Digital Inputs (Frequency/Counter) (Optimized for 60 Hz)

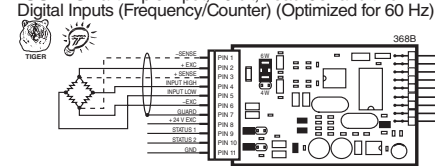

ISSE: Smart Dual Photo Diode Input

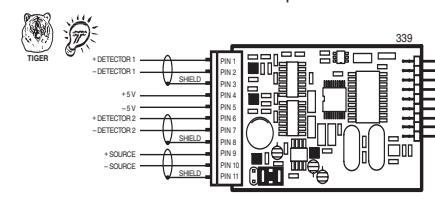

I-Series Input Signal Conditioning Modules continued

IST1: Smart 6 Inputs- 3 RTDs, 2 Proc. & 1 Dig. Input. 50 Hz
IST2: Smart 6 Inputs- 3 RTDs, 2 Proc. & 1 Dig. Input. 60 Hz

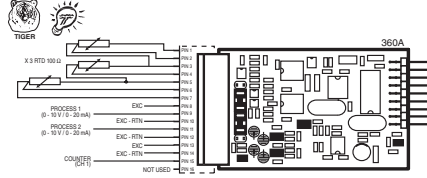

IST3: Smart Quad Thermocouple. 50 Hz
IST4: Smart Quad Thermocouple. 60 Hz

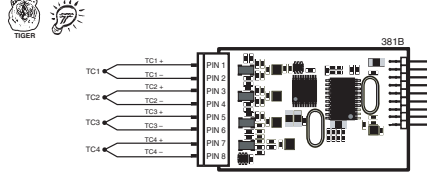

IST5: Smart Dual RTD with 0.01° Res. 50 Hz
IST6: Smart Dual RTD with 0.01° Res. 60 Hz

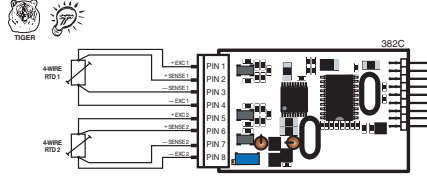

IT01: Thermocouple (J/K/R/S/T/B/N)

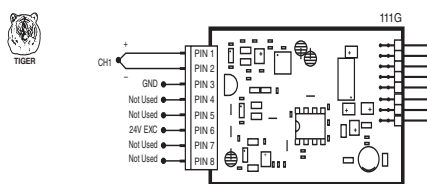

IT02: RTD, 100Ω Pt. 2/3/4-wire
IT12: RTD, 120Ω Nickel 2/3/4-wire
IT13: RTD, 10Ω Copper 2/3/4-wire

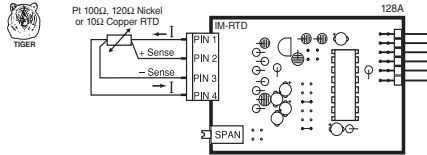

IT03: RTD, 100Ω Pt. 2/3/4-wire (-200 to 800°C)
IT04: RTD, 100Ω Pt. 2/3/4-wire (-200 to 1470°F)
IT05: RTD, 100Ω Pt. 2/3/4-wire (-199.9 to 199.9°F)
IT14: RTD, 100Ω Pt. 2/3/4-wire (-199.9 to 199.9°C)

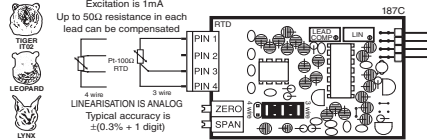

ITD1: Triple DC Volts, 2V DC
ITD2: Triple DC mV, 50mV DC

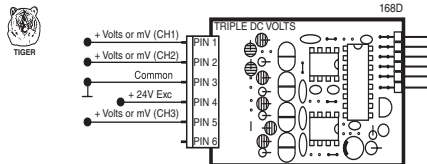

ITP1: Triple 4 to 20mA

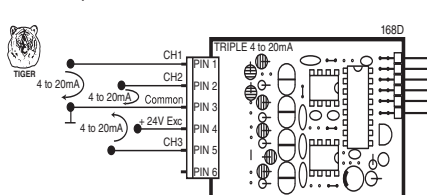

ITT1: Triple Thermocouple (J/K/R/S/T/B/N)

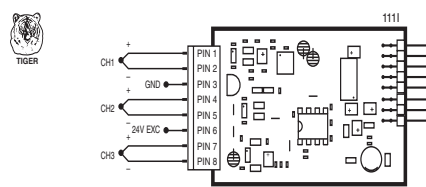

ITT2: Triple RTD Platinum 100Ω RTD
 2 Wire Connection

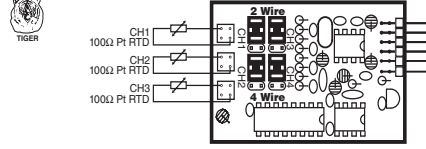

All three RTDs **must** be connected for the meter to work.

ITT3: Triple Input- T/C, T/C (J/K/R/S/T/B/N) and 2VDC Input
ITT5: Triple Input- T/C, T/C (J/K/R/S/T/B/N) and 50mV DC

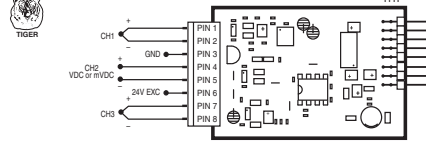

ITT4: Triple Input- T/C, T/C (J/K/R/S/T/B/N) and 4 to 20mA

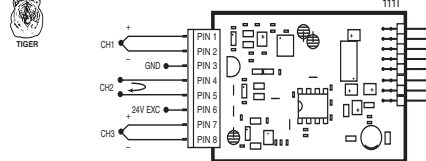

ITT6: Triple Input- T/C (J/K/R/S/T/B/N), 50mV DC and 50mV DC
ITT7: Triple Input- T/C (J/K/R/S/T/B/N), 2VDC and 2VDC

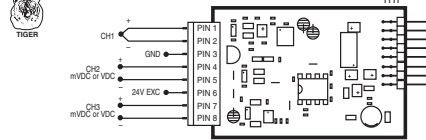

ITT8: Triple Input- T/C (J/K/R/S/T/B/N), 4 to 20mA and 4 to 20mA

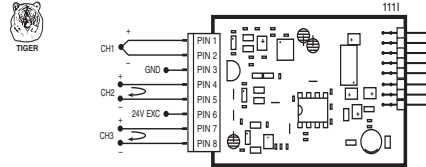

ITT9: Triple Input- T/C (J/K/R/S/T/B/N), DCV and 50mV DC

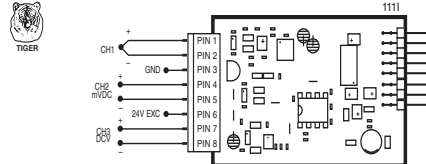

ITTA: Triple Input- T/C (J/K/R/S/T/B/N), 4 to 20mA and 50mV DC
ITTB: Triple Input- T/C (J/K/R/S/T/B/N), 4 to 20mA and 2VDC

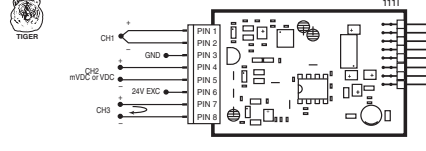

ITTC: Triple RTD Platinum 100Ω RTD
 4 Wire Connection

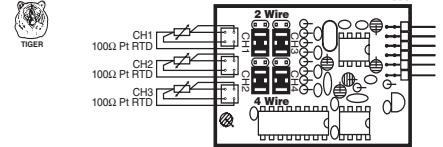

All three RTDs **must** be connected for the meter to work.

ITTE: Triple Input- RTD / RTD / FREQ

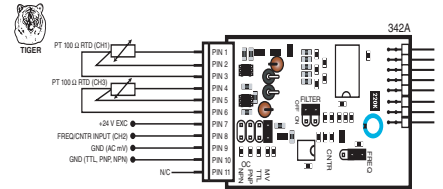

ITTF: Triple Input - Thermocouple / 4-20mA / Frequency
ITTG: Triple Input - Thermocouple / V / Frequency

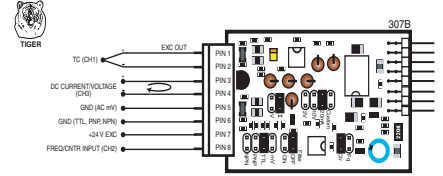

IWO1: Single Phase Power, 300V/1A
IWO2: Single Phase Power, 300V/5A
IWO4: Single Phase Power, 600V/1A
IWO5: Single Phase Power, 600V/5A

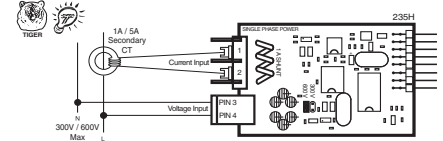

IWO3: DC-Watts, 10V/50mV DC

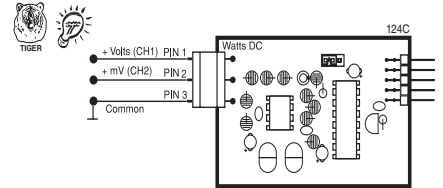

INPUT MODULE COMPONENT GLOSSARY

Dual input modules, and those modules exclusively compatible with the Leopard or Tiger Families, do not have zero and span adjustments. These modules are scaled and calibrated using the internal software functions of each individual meter.

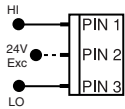

Input and Output Pins

On most modules Pin 1 is the Signal High input and Pin 3 is the Signal Low input. Typically Pin 2 is used for Excitation Voltage output.

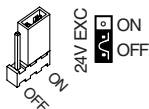

24 V DC Output for 4-20 mA Header

On some modules this header enables a 24 V DC 25 mA (max) Excitation/Auxiliary output to be connected to Pin 2 that can power most 4-20 mA transmitters.

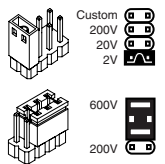

INPUT RANGE Headers

Range values are marked on the PCB. Typically two to eight positions are provided, which are selected with either a single or multiple jumper clip. When provided, a custom range position is only functional when the option has been factory installed.

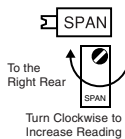

SPAN Potentiometer (Pot)

If provided, the 15 turn SPAN pot is always on the right side (as viewed from the rear of the meter). Typical adjustment is 20% of the input signal range.

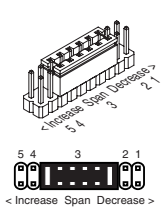

SPAN ADJUST Header

This unique five-position header expands the adjustment range of the SPAN pot into five equal 20% steps, across 100% of the input Signal Span. Any input Signal Span can then be precisely scaled down to provide any required Display span from full scale to the smallest viewable unit.

SPAN Adjust Header position	1	2	3	4	5
SPAN Pot %	20%	20%	20%	20%	20%
Signal Span %	20%	40%	60%	80%	100%

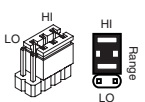
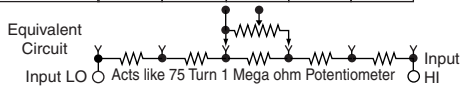

SPAN RANGE Header

When this header is provided it works in conjunction with the SPAN ADJUST Header by splitting its adjustment range into a Hi and a Lo range. This has the effect of dividing the adjustment range of the SPAN pot into ten equal 10% steps across 100% of the input Signal Span.



SPAN Adjust Header position	1	2	3	4	5	1	2	3	4	5
SPAN Pot %	10%	10%	10%	10%	10%	10%	10%	10%	10%	10%
Signal Span %	10%	20%	30%	40%	50%	60%	70%	80%	90%	100%

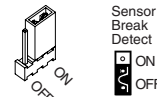
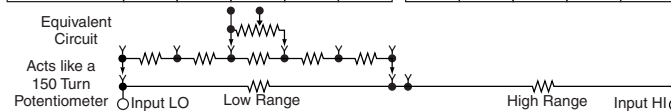

Function Select Headers

On some modules various functions such as Amps and Volts, 4 wire and 6 wire, or cold junction compensation are selected by header positions that are marked on the PCB.

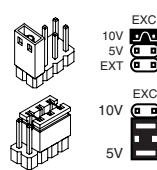
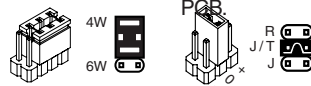

Excitation Output Select Headers

When excitation outputs are provided, they are typically 5 V DC max 30 mA, 10 V DC max 30 mA (300Ω or higher resistance) or external supply. They are selected by either a single or multiple jumper clip.

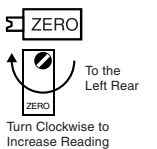

ZERO Potentiometer (Pot)

If provided, the ZERO pot is always to the left of the SPAN pot (as viewed from the rear of the meter). Typically it enables the input signal to be offset ±5% of the full scale display span.

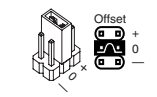
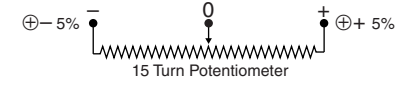

ZERO OFFSET RANGE Header

When provided, this three position header increases the ZERO pot's capability to offset the input signal, by ±25% of the full scale display span. For example a Negative offset enables a 1 to 5 V input to display 0 to full scale. The user can select negative offset, positive offset, or no offset (ZERO pot disabled for two step non-interactive span and offset calibration).

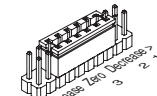
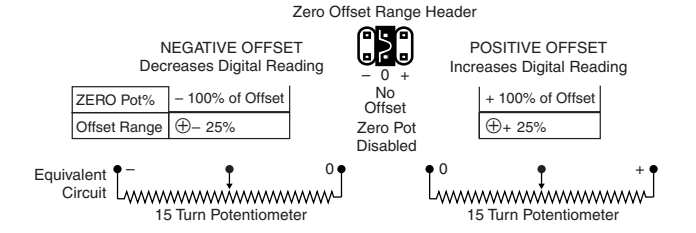

ZERO ADJUST Header

When this header is provided, it works in conjunction with the ZERO OFFSET RANGE Header, and expands the ZERO pot's offset capability into five equal negative steps or five equal positive steps. This enables virtually any degree of input signal offset required to display any desired engineering unit of measure.

ZERO Adjust Header Position	5	4	3	2	1	1	2	3	4	5
ZERO Pot Span	6400	6400	6400	6400	6400	6400	6400	6400	6400	6400
Offset Range	-25200 to -31600	-18900 to -25300	-12600 to -19000	-6300 to -12700	0 to -6400	0 to +6400	+6300 to +12700	+12600 to +19000	+18900 to +25300	+25200 to +31600

CALIBRATE position, Zero Pot disengaged (no offset applied)

Case Dimensions

PANEL CUTOUT

Case will mount in standard DIN cutouts

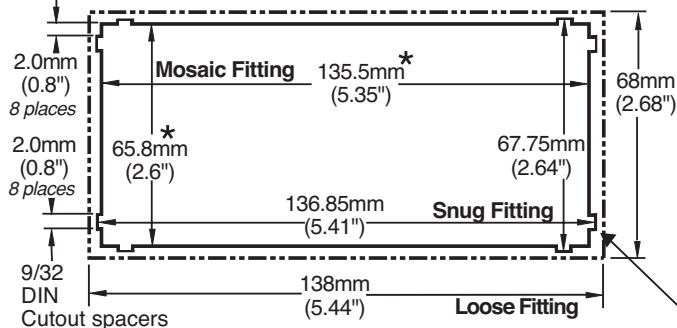

* These dimensions are increased by 2mm (0.08") when the metal surround case is installed.

For extra strength in portable applications, the 8 DIN spacers should be snipped off and the **Mosaic fitting** cutout used. Alternatively, the **High Strength Panel Mounting Kit** can be used.

SIDE VIEW

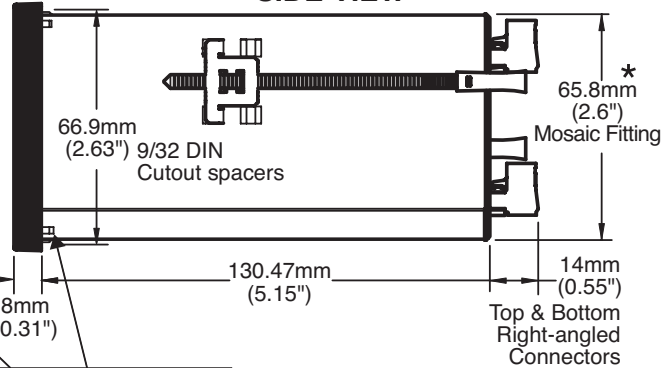

Metal Surround Case

P/N:(OP-MTL144X72)

NOTE: The Metal Surround Case is pre-installed at the factory and cannot be removed without damage to the case.

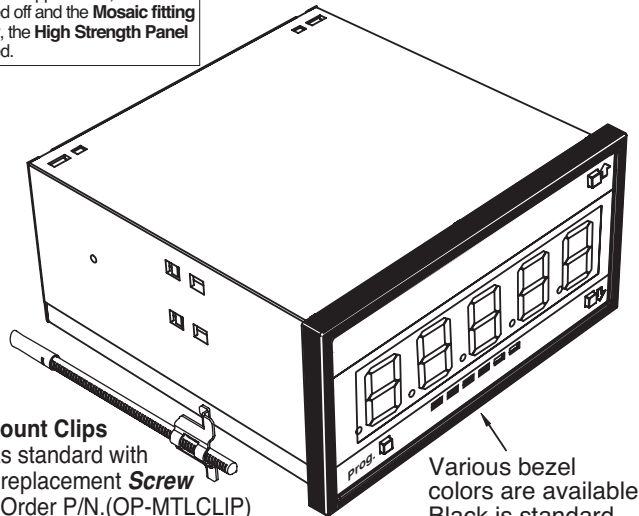
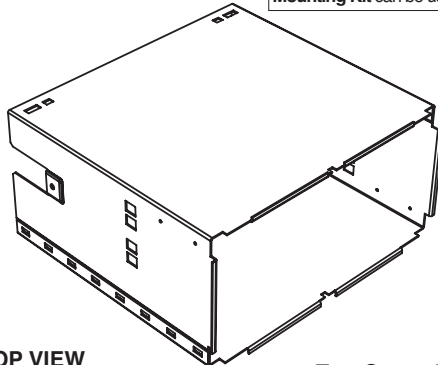

Two Screw Mount Clips are supplied as standard with this case. For replacement **Screw Mount Clips**, Order P/N.(OP-MTLCLIP)

Various bezel colors are available. Black is standard.

FRONT VIEW

9/32 DIN 144x72mm

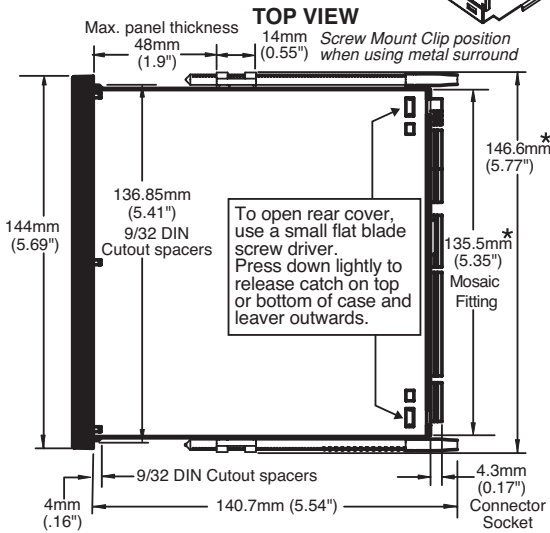

To open rear cover, use a small flat blade screw driver. Press down lightly to release catch on top or bottom of case and lever outwards.

Panel adaptor plates are available to retrofit most existing panel cutouts.

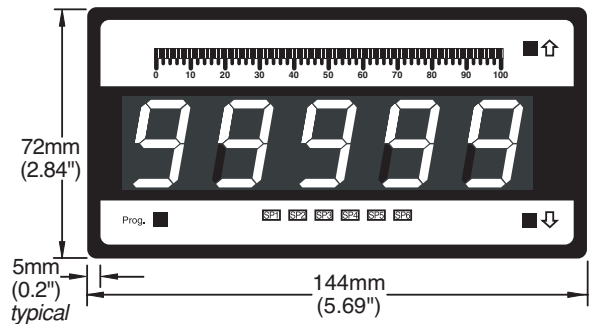

WARRANTY

Texmate warrants that its products are free from defects in material and workmanship under normal use and service for a period of one year from date of shipment. Texmate's obligations under this warranty are limited to replacement or repair, at its option, at its factory, of any of the products which shall, within the applicable period after shipment, be returned to Texmate's facility, transportation charges pre-paid, and which are, after examination, disclosed to the satisfaction of Texmate to be thus defective. The warranty shall not apply to any equipment which shall have been repaired or altered, except by Texmate, or which shall have been subjected to misuse, negligence, or accident. In no case shall Texmate's liability exceed the original purchase price. The aforementioned provisions do not extend the original warranty period of any product which has been either repaired or replaced by Texmate.

USER'S RESPONSIBILITY

We are pleased to offer suggestions on the use of our various products either by way of printed matter or through direct contact with our sales/application engineering staff. However, since we have no control over the use of our products once they are shipped, NO WARRANTY WHETHER OF MERCHANTABILITY, FITNESS FOR PURPOSE, OR OTHERWISE is made beyond the repair, replacement, or refund of purchase price at the sole discretion of Texmate. Users shall determine the suitability of the product for the intended application before using, and the users assume all risk and liability whatsoever in connection therewith, regardless of any of our suggestions or statements as to application or construction. In no event shall Texmate's liability, in law or otherwise, be in excess of the purchase price of the product.

Texmate cannot assume responsibility for any circuitry described. No circuit patent or software licenses are implied. Texmate reserves the right to change circuitry, operating software, specifications, and prices without notice at any time.



995 Park Center Drive • Vista, CA 92081-8397

Tel: 1-760-598-9899 • USA 1-800-839-6283 • That's 1-800-TEXMATE

Fax: 1-760-598-9828 • Email: sales@texmate.com • Web: www.texmate.com

Texmate has facilities in Japan, New Zealand, Taiwan, and Thailand. We also have authorized distributors throughout the USA and in 28 other countries.

For product details visit www.texmate.com

Local Distributor Address