



TEXMATE



Dust and Splash proof
Membrane Face Plate

DX-45-DCV

2V/20V/200V DC Meter
4 1/2 Digit with 0.56"
in a 1/8 DIN Case

A cost-effective easily installed meter,
for Switchboard and Process Indication of
single, or differential DC voltage signals.

General Features

The DX-45-DCV is a reliable cost-effective DC voltage measuring meter with three header selectable full scale ranges of 2V, 20V and 200V. This meter may be used to measure single-ended as well as differential signals and is easily scaled to any desired process engineering unit. After selecting a new range, re-calibration is required. Display Hold and Display Test functions are also provided.

The standard meter has a high efficiency red LED display.

Typical Application Connections

DC Volts Single-ended measurement with
a Resolution of 100 milliVolt.

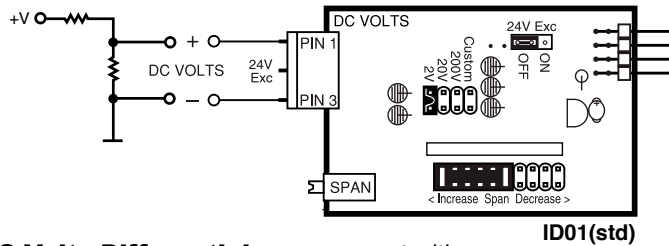

DC Volts Differential measurement with
a Resolution of 100 milliVolt.

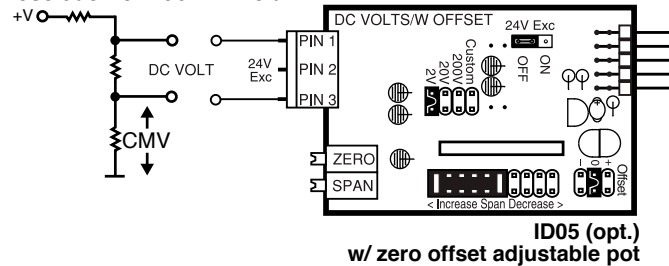

Max CMV (common mode voltage) is 50V.*

*Because CMV is common with meter ground, higher CMV inputs to a max of 1KV, require mechanical isolation of all contactable meter parts.

Compatibility

The DX-Series have a matching DIN case style that is complementary to the Leopard and Tiger family of meters. DX-Meters are the OEM's choice for switchboard and process indication. Each model is dedicated to a specific application and designed for quick and easy installation.



Specifications

- Input Configuration:**... Single-ended, however isolated power supply enables differential measurements up to maximum common mode of 50V.*
- Full Scale Ranges:**..... Three header selectable ranges of 2V, 20V, and 200V DC full scale
- A/D Converter:**.....12 bit dual slope
- Input Impedance:**..... 1MΩ (minimum)
- Accuracy:**.....±(0.05% of reading + 3 counts)
- Temp. Coeff.:**.....100 ppm/°C (Typical)
- Warm up time:**.....1 minute to specified accuracy.
- Conversion Rate:**.....3 reading per second
- Display:**.....**4 1/2 digit 0.56" Red LED display (std),**
0.56" Green or Super Bright Red (optn).
Range -19999 to 19999 counts.
- Decimal Selection:**.....Header under face plate, X•X•X•X•X
- Positive Overrange:**...All 0000 flash.
- Negative Overrange:** Negative sign - and all 0000 flash.
- Power Supply:**.....AC/DC Auto sensing wide range supply
PS1 (std)85-265 VAC, 50-400Hz / 95-300 VDC @1.5W
PS215-48 VAC, 50-400Hz / 10-72 VDC @4.0W
- Operating Temp.:**.....0 to 50 °C
- Storage Temp.:**.....-20 °C to 70 °C.
- Relative Humidity:**.....95% (non condensing)
- Case Dimensions:**.....1/8 DIN, Bezel: 96x48 mm (3.78"x1.89")
Depth behind bezel: 117 mm (4.61")
Plus 11.8 mm (0.47") for Right-angled connector or plus 20 mm (0.79") for Straight-thru connector.
- Weight:**.....8 oz., 11 oz when packed.
- Certification:**.....UL Listed.

DX-Series, the OEMs choice for switchboard and process indication

- DX-35-DCV**..... DC volts ±2V/±20V/±200V Header Selectable Ranges, 3.5 digit
- DX-35-DCA**..... DC mV ±50mV, ±100mV, ±200mV Header Selectable Ranges, 3.5 digit
- DX-35-ACV**..... AC volts, Scaled RMS (True RMS Opt.). 199.9/300V AC Header
.....Selectable Ranges, 3.5 digit
- DX-35-ACA**..... AC amps, Scales RMS (True RMS Opt.). (5 Amp Internal Shunt), 3.5digit
- DX-35-CL**..... Process 4 to 20mA (100.0), easily user scalable, 3.5 digit w/Exc. opt
- DX-35-HZ**..... AC Line Frequency 15.0Hz to 199.9Hz. Up to 300V AC input, 3.5 digit
- DX-35-TC-KF**..... K Thermocouple with °F, optional °C, 3.5 digit
- DX-35-TC-JF**..... J Thermocouple with °F, optional °C, 3.5 digit
- DX-35-RTD-F**..... 100Ω platinum RTD, 3 or 4 wire, °F in 1° resolution, optional °C, 3.5 digit
- DX-40-ACV**..... AC volts, Scaled RMS (True RMS Opt.). 300.0V AC full scale, 4 digit
- DX-45-ACA**..... AC amps, Scaled RMS (True RMS Opt.). (5 Amp Internal shunt), 4.5 digit
- DX-45-DCV**..... DC volts ±2V/±20V/±200V Header Selectable Ranges, 4.5 digit
- DX-45-DCA**..... DC mV ±50mV/±100mV/±200mV Header Selectable Ranges, 4.5 digit
- DX-45-CL**..... Process 4 to 20mA (100.00), easily user scalable, 4.5 digit w. Exc opt.

Connector Pinouts

This meter uses plug-in type screw terminal connectors for all connections.

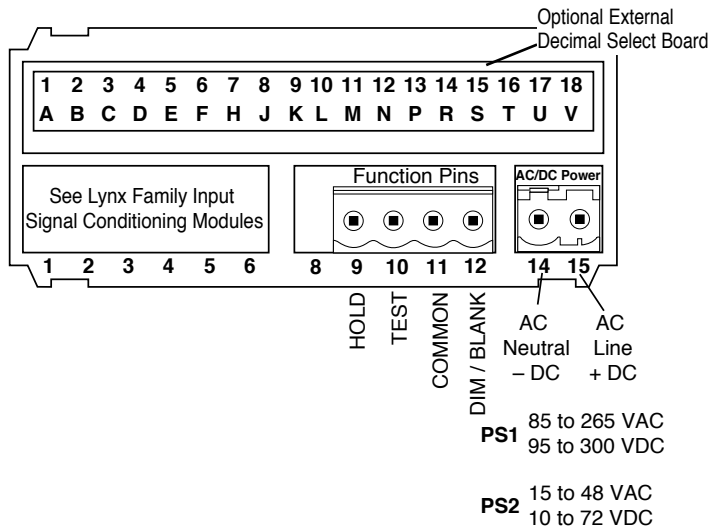

Pin Descriptions

Pin 1 - Signal Input High: Signal high input for the meter. Full scale ranges of 2V/20V/200V can be selected on the Range Select Header.

Pin2- 24V Excitation: 24V Excitation. ON/OFF Header selectable.

Pin3- Signal Input Low: Signal low input for the meter.

Pin 9 - Hold: If this pin is left unconnected the meter will operate in a free running mode. When this pin is connected to the Common Pin 11, the meter display will be latched. A/D conversions will continue, but the display will not be updated until Pin 9 is disconnected from Pin 11.

Pin 10 - Display Test: When this pin is connected to the Common Pin 11, all segments of the display light up and 1888 is displayed. This is used to detect any missing segments in the display.

Pin 11 - Common: To Hold, Test or Dim the display, the respective pins have to be connected to this Common Pin.

Pin 12 - Dim/Blank: When this pin is connected to the Common Pin 11 the display is blanked out. If it is connected through an external 1K Ω pot, the display may be dimmed.

Pin 14 & 15 - AC/DC Power Input: These pins are the power pins of the meter and they only accept a special polarized screw terminal plug that can not be inserted into any other input socket. The standard meter has a auto sensing AC/DC power supply that operates from 85-265 VAC/95-300 VDC (PS1 Std). An optional isolated low voltage power supply that operates from 15-48 VAC/10-72 VDC (PS2) is also available.

OPTIONAL EXTERNAL DECIMAL POINT SELECTION BOARD

Pins 6, F - Decimal Common: Connect to these pins to activate decimals.

Pins 7, H - Decimal XXXX.: Connect to pin 6 or pin F to activate decimal XXXX..

Pins 8, J - Decimal XXX.X: Connect to pin 6 or pin F to activate decimal XXX.X.

Pins 9, K - Decimal XX.XX: Connect to pin 6 or pin F to activate decimal XX.XX.

Pins 10, L - Decimal X.XXX: Connect to pin 6 or pin F to activate decimal X.XXX.

Calibration Procedure

1. Select the required full scale voltage range by re-positioning the jumper clip on the Range Select Header. A range of 2V, 20V or 200V full scale may be selected.
2. Apply an input of 0 Volt DC to the meter by shorting the inputs. The meter will auto zero and display zero.
3. If you need to offset zero, order the ID05 option and adjust until the meter reads 0000.
4. Apply a known high input signal that is within the full scale voltage range selected.
5. Adjust the Span Pot until the meter displays the required reading for the signal being applied. (e.g.: 1VDC=1.000)
6. The DX-35-DCV is now calibrated and ready for use.

(Whenever a new range is selected, re-calibration is required to meet the specified accuracy).

Component Layout

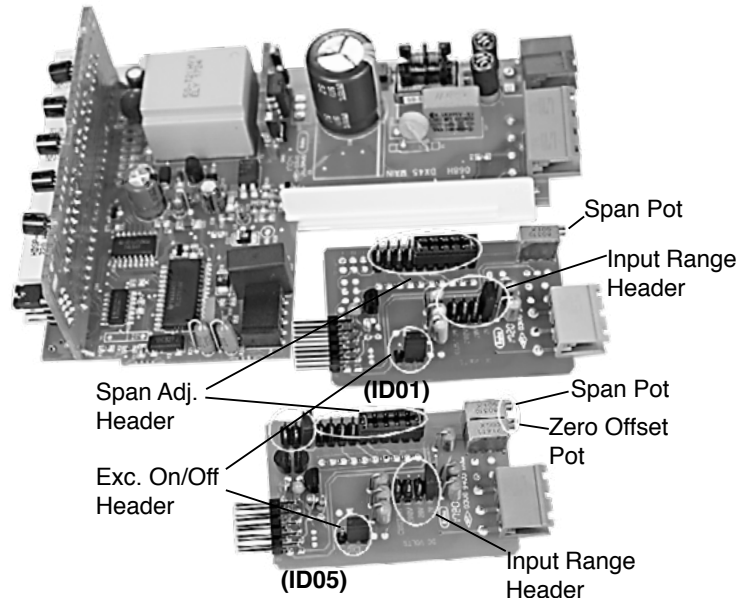

Signal Conditioning Components

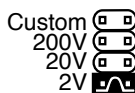

INPUT RANGE Header

Range values are marked on the PCB. Four positions are provided. After selecting a new range with the single jumper clip, re-calibration is required.

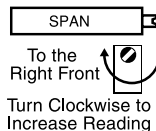

SPAN Potentiometer (Pot)

The 15 turn SPAN pot is always on the right side (as viewed from the front of the meter). Typical adjustment is 100% of the input signal range.

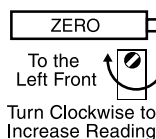

ZERO Potentiometer (Pot) (when ID05 is ordered)

The Optional ZERO pot when installed is always to the left of the SPAN pot (as viewed from the front of the meter). Typically it enables the displayed reading to be offset ± 1000 counts.

Opening Back Panel



To open back panel, insert a flat screwdriver or similar instrument in both slots on the top of the case and pry open. The DX-Series meters slide out from the rear of the case as a complete assembly.

Decimal Point Selection

0.56" LED Display
Cut loop to turn OFF last digit

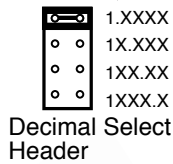
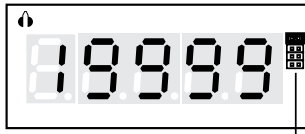

1.XXXX
1X.XXX
1XX.XX
1XXX.X



Decimal selection is made by moving the jumper to the indicated position on the header for the decimal required on the front of the display board.

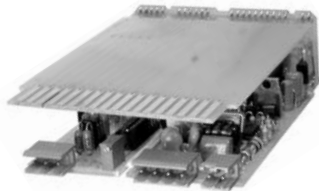

Optional External Decimal Point Selection Board

An optional output board is available that provides access to all decimal points via a rear PCB edge connector.

Connectors

This meter uses plug-in type screw terminal connectors for all input and output connections. The power supply connections (pins 14 and 15) have a unique plug and socket outline to prevent cross connection. The main board uses standard right-angled connectors.

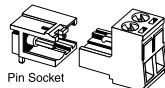

Pin Socket
Input Power Screw Terminal Plug

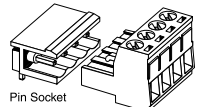

Pin Socket
Right-angled Screw Terminal Plug



WARNING: AC and DC input signals and power supply voltages can be hazardous. Do Not connect live wires to screw terminal plugs, and do not insert, remove or handle screw terminal plugs with live wires connected.

Installation Guidelines

1. Install and wire meter per local applicable codes/regulations, the particular application, and good installation practices.
2. Install meter in a location that does not exceed the maximum operating temperature and that provides good air circulation.
3. Separate input/output leads from power lines to protect the meter from external noise. Input/output leads should be routed as far away as possible from contactors, control relays, transformers and other noisy components. Shielding cables for input/output leads is recommended with shield connection to earth ground near the meter preferred.
4. A circuit breaker or disconnect switch is required to disconnect power to the meter. The breaker/switch should be in close proximity to the meter and marked as the disconnecting device for the meter or meter circuit. The circuit breaker or wall switch must be rated for the applied voltage (e.g., 120VAC or 240VAC) and current appropriate for the electrical application (e.g., 15A or 20A).
5. See *Case Dimensions* section for panel cutout information.
6. See *Connector Pinouts* section for wiring.
7. Use 28-12 AWG wiring, minimum 90°C (HH) temperature rating. Strip wire approximately 0.3 in. (7-8 mm).
8. Recommended torque on all terminal plug screws is 4.5 lb-in (0.51 N-m).



Metal Surround Case Option

The meter's plastic case is made from fire retardant polycarbonate. A metal surround case can be ordered to enhance the meter's fire retardant capabilities and also provide shielding against electromagnetic interference (EMI). The metal case slides over the polycarbonate case and is held firmly in place by spring-type non-return clips. The Metal Surround Case must be factory installed on the polycarbonate case and once installed, it cannot be removed in the field.

With the metal case in place, the meter's standard ratchet-type mounting clips can not be used. Instead a pair of screw-type DIN standard mounting clips are provided, which clip into holes on the side of the metal case and tighten against the rear of the panel. A ground tab on the metal case enables the metal case to be easily connected to the panel ground.

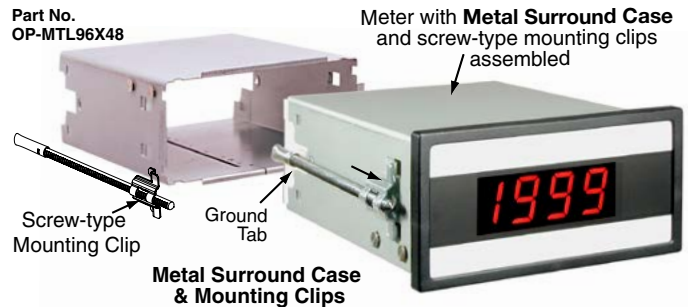

Clear Lockable Water-proof Cover

The clear lockable cover is designed to be dust and water proof to NEMA-4X, IP65 standards. The assembly consists of a base and cover with a cam hinge and key-lock fastening mechanism. An O-ring, or neoprene gasket forms a seal between the base and the panel. The cam hinge prevents the cover from closing when opened until pushed closed. The cover has a tapered recess that, when closed, forms a seal with a tapered spigot on the base. A key-lock employs a cam locking device to force the spigot into the recess, ensuring seal integrity. A safety catch keeps the cover closed even when the key is removed, and the

keyhole can be used to attach a safety seal clip, preventing unauthorized opening.

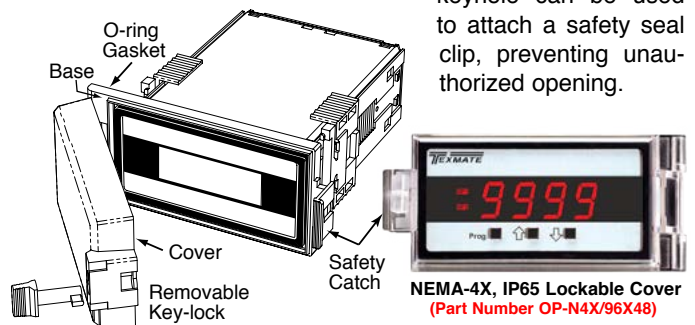

NEMA-4X, IP65 Lockable Cover
(Part Number OP-N4X/96X48)

Optional Face Plate Descriptors



To customize the face plate, clear adhesive label containing various popular descriptors may be ordered. Choose the descriptor desired, peel off the adhesive backing and align the descriptor in the center right of the faceplate.

P.N.: DU-CASEDES

DX Case Dimensions and Panel Cutouts

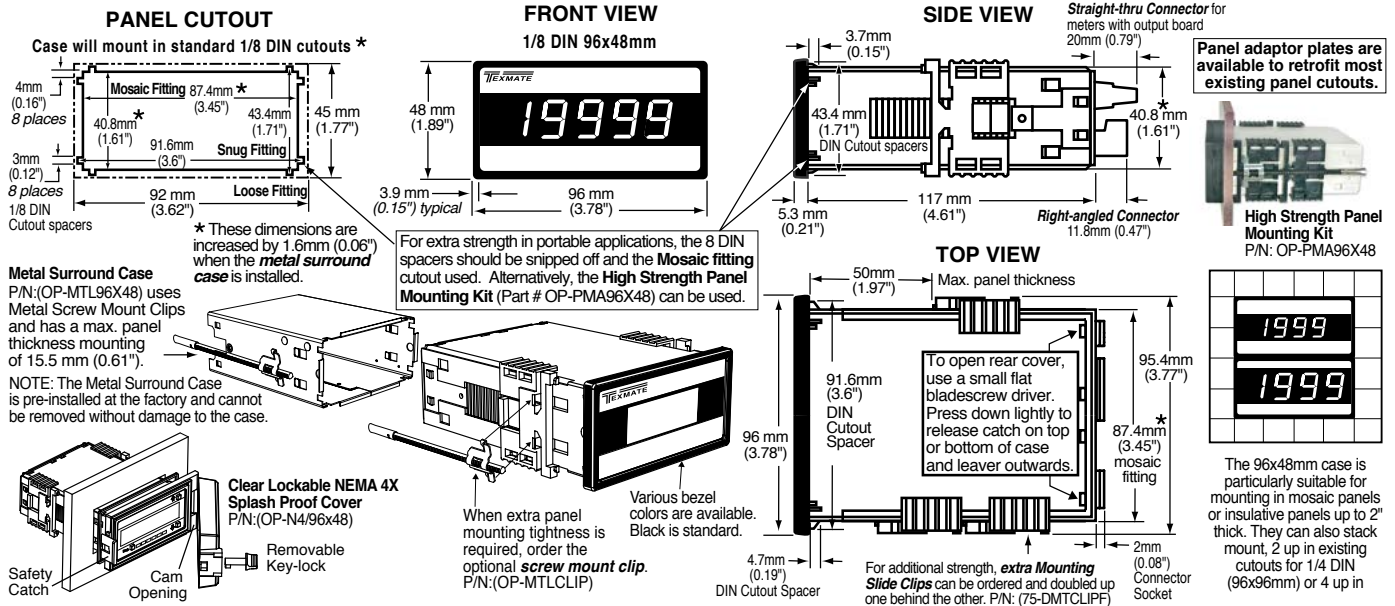

Ordering Information

Standard Options for this Model Number

Part Number	Description	List
-------------	-------------	------

► **BASIC MODEL NUMBER** Includes plug in type screw terminals, standard display and standard power supply unless optional versions are ordered.
DX-45-DCV..... DC Volts, 2V/20V/200V w/24V Exc. ID01
Offset option..... with zero offset adjustable pot ID05.

► DISPLAY

DR . . . Red LED, 0.56 inch high
DB . . . Super-bright Red LED, 0.56 inch high
DG . . . Green LED, 0.56 inch high

► POWER SUPPLY

PS1 . . . 85-265VAC/95-300VDC
PS2 . . . 15-48VAC/10-72VDC

Special Options and Accessories

Part Number	Description	List
-------------	-------------	------

► SPECIAL OPTIONS (Specify Inputs or Outputs & Req. Reading)

CR-CHANGE . . . Calibrated Range Change to another Standard Range. . .
CS-4.5/5/6 . . . Custom display scaling within std. ranges
OP-DXEXTDP . . External Dec. Pt. W/Conn. Option-Factory Installed . .

► ACCESSORIES (Specify Serial # for Custom Artwork Installation)

75-DBBZ9648F . . Extra Black Bezel for 96x48mm Case
75-DMTCLIPF . . Side Slide Brackets (2 pc) - extra set, extra strength
76-D45G-N4 . . . NEMA 4 Green LED Faceplate, Factory Installed
76-D45R-N4 . . . NEMA 4 Red LED Faceplate, Factory Installed
CN-L18 Dual Row 18 Pin Edge Connector, Solder Type
DN.CAS96X48B . Complete 96 X 48 mm Case with bezel
OP-MTLCLIP . . . Screw Mount Clips (2 pc) - to screw tighten slide brackets
OP-MTL96X48 . . Metal Surround Case, includes screw mounting clips
OP-N4X/96X48 . . 96x48mm clear lockable front cover-NEMA 4X, splash proof
OP-PSA/96X48 . Panel to Case Seal Adapter with O-Ring and Foam Gasket
DU-CASEDES . . Clear adhesive descriptors label for face plate

WARRANTY

Texmate warrants that its products are free from defects in material and workmanship under normal use and service for a period of one year from date of shipment. Texmate's obligations under this warranty are limited to replacement or repair, at its option, at its factory, of any of the products which shall, within the applicable period after shipment, be returned to Texmate's facility, transportation charges pre-paid, and which are, after examination, disclosed to the satisfaction of Texmate to be thus defective. The warranty shall not apply to any equipment which shall have been repaired or altered, except by Texmate, or which shall have been subjected to misuse, negligence, or accident. In no case shall Texmate's liability exceed the original purchase price. The aforementioned provisions do not extend the original warranty period of any product which has been either repaired or replaced by Texmate.

USER'S RESPONSIBILITY

We are pleased to offer suggestions on the use of our various products either by way of printed matter or through direct contact with our sales/application engineering staff. However, since we have no control over the use of our products once they are shipped, NO WARRANTY WHETHER OF MERCHANTABILITY, FITNESS FOR PURPOSE, OR OTHERWISE is made beyond the repair, replacement, or refund of purchase price at the sole discretion of Texmate. Users shall determine the suitability of the proDxct for the intended application before using, and the users assume all risk and liability whatsoever in connection therewith, regardless of any of our suggestions or statements as to application or construction. In no event shall Texmate's liability, in law or otherwise, be in excess of the purchase price of the product.

Texmate cannot assume responsibility for any circuitry described. No circuit patent or software licenses are implied. Texmate reserves the right to change circuitry, operating software, specifications, and prices without notice at any time.



450 State Place • Escondido, CA 92029
 Tel: 1-760-598-9899 • USA 1-800-839-6283 • 1-800-TEXMATE
 Fax: 1-760-598-9828 • Email: orders@texmate.com • Web: www.texmate.com

DX-45-DCV Technical Manual Copyright © 2018 Texmate Inc. All rights reserved. Published by: Texmate Inc. USA. Information in this Technical Manual is subject to change without notice due to correction or enhancement. The information described in this manual is proprietary to Texmate, Inc. and may not be copied, reproduced or transmitted, in whole or in part, in connection with the design, manufacture, or sale of apparatus, device or private label product without the express written consent of Texmate, Inc.