



4 Digit 0.56" LEDs in a 1/16 DIN Case



LEOPARD FAMILY

BL-40PSF-ACA
scalable to read the Primary CT up to 9999A
with a 5 Amp or 1 Amp secondary

BL-40PSF-ACV
scalable to read any PT up to 9999V
with secondary of 120/240 VAC

**Built-in Programmable Scale Factor
No Input required to calibrate**

**Smart AC Amp or AC Volt Meter, Transmitter and
Controller with optional 4-20mA or 0-10 VDC Output.**

General Features

- External transmitters or signal conditioners can be eliminated by direct connection of the sensor output to :
 - AC Current
 - IA05 : AC-Amps Scaled RMS, **0-5 Amp AC**
 - IA11 : AC-Amps True RMS, **0-5 Amp AC**
 - AC Voltage
 - IA01 : AC-Volts Scaled RMS, **200/300V AC**
 - IA06 : AC-Volts True RMS, **200/300V AC**
- Optional isolated 16 bit analog output. User or factory scalable to 4 to 20 mA, 0 to 20 mA or 0 to 10 V across any desired digital span from \pm one count to the full scale range of 0 to 9999.
- Auto-sensing AC/DC power supply. For voltages between **85-265 V AC / 95-300 V DC (PS1)** or 15-48 V AC / 10-72 V DC (PS2).
- Standard red or optional green or super bright red 4-digit LED with display range 0 to 9999.
- Three annunciator LEDs provide front panel alarm status indication for up to three setpoints.
- One 9 Amp Form C and one 4 Amp Form A relays, or up to three 4 Amp Form A relays are available.
- Automatic intelligent averaging smooths noisy signals, while providing a fast display response to real input signal changes.

Software Features

- Three-button programming from the front panel (UP, DOWN and PROGRAM buttons).
- Front panel selectable four-level brightness control of digital display.
- Three programmable setpoints.
- Relay activation can be selected to occur above (HI) or below (LO) each setpoint.
- Hysteresis setting for all three setpoints. Delay on make and delay on break for SP1 and SP2.
- Peak and Valley. View and Reset.

Specifications



- Input Specs:** Depends on input signal conditioner
A/D Converter: 14 bit single slope
Accuracy: \pm (0.05% of reading + 2 counts)
Temp. Coeff.: 100 ppm/ $^{\circ}$ C (Typical)
Warm up time: 2 minutes
Conversion Rate: 5 conversions per second (Typical)
Display: **4 digit 0.56" Red LED display (std)**,
 0.56" Green or Super Bright Red are optional. Range 0 to 9999 counts.
Polarity: Assumed positive. Displays – negative
Decimal Selection: Front panel button selectable, X•X•X•X•
Positive Overrange: Top segments of digital display flash
Negative Overrange: Bottom segments of digital display flash
Relay Output: Three 4 Amp Form A relays or one 9 Amp
 Form C, and one 4 Amp Form A relay.
Analog Output: Isolated 16 bit user scalable mA or V
 OIC (mA out) 4-20 mA @ 0 to 500 Ω max loop resistance
 OIV (volts out) 0-10 V DC @ 500 Ω or higher resistance
Power Supply: AC/DC Auto sensing wide range supply
PS1 (std) **85-265 VAC / 95-300 VDC @ 2.5W max 3.2W**
PS2 15-48 VAC / 10-72 VDC @ 2.5W max 3.2W
Operating Temp.: 0 to 50 $^{\circ}$ C
Storage Temp.: –20 $^{\circ}$ C to 70 $^{\circ}$ C.
Relative Humidity: 95% (non condensing)
Case Dimensions: 1/16 DIN Bezel 96x24mm
 Depth behind bezel 122.2mm (4.83")
 Plus 12.7mm (0.5") for Right-angled connectors
Weight: 7 oz, 9 oz when packed

Index

Case Dimensions 9	Digital Rescaling 4	Input Module Compatibility 1	Setpoint Setting & Relay Configuration Mode 6
Component Layout 8	Digital Rescaling Procedure 4	Input Module Component Glossary 9	Software Features 1
Connector Pinouts 7	Digital Span Selection for 7	Installation Guideline 7	Software Logic Tree 3
Connectors 7	Analog Range Output 5	Ordering Information 10	Specifications 1
Controls and Indicators 2	General Features 1	Pin Descriptions 7	Two Point Analog Output Range Setting & Calibration 5
Decimal Point & Brightness Selection 5	Glossary of Programming Symbols 2		

Front Panel Buttons

Program Button

The  button is used to move from one program step to the next. When pressed at the same time as the  button, it initiates the **calibration mode**. When pressed at the same time as the  button, it initiates the **setpoint setting mode**.

Up Button

When in the operational display, pressing the  button alone, allows you to view and reset the Peak and Valley (Highest and Lowest Readings.)

When in the **calibration mode** or the **setpoint setting mode** the  button is used to increase the value of the displayed parameter.

Down Button

When in the operational display, pressing the  button alone, allows you to view, but not change, the setting of setpoint 1, 2 and 3.

When in the **calibration mode** or the **setpoint setting mode** the  button is used to decrease the value of the displayed parameter.



Glossary of Programming Symbols

To explain software programming procedures, logic diagrams are used to visually assist in following the programming steps. The following symbols are used throughout the logic diagrams to represent the buttons and indicators on the meter:

Symbol **Explanation**



This symbol represents the OPERATIONAL DISPLAY.



This is the PROGRAM button.



This is the UP button.



This is the DOWN button.

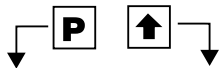

When a button is shown, press and release it to go onto the next step in the direction indicated by the arrow. When two or more buttons are shown, each with an arrow, this indicates that there is a number of programming choices.



When two buttons are shown side by side and enclosed by a dotted line, they must be pressed at the same time then released to go onto the next programming step.



If the display is shown with XXXX it means the value displayed will be the previously set value. When a number is shown it indicates the initial factory default setting or a specific "example number".

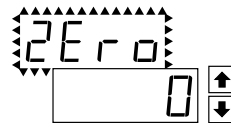



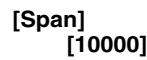

When two displays are shown together with bursts, this indicates that the display is toggling (flashing) between the name of the function and the value.

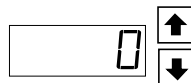





Text or numbers shown between square brackets in a procedure indicate the programming code name of the function or the value displayed on the meter display.

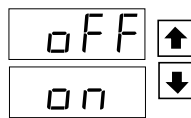



When the  and  buttons are shown together, the display value can be increased by pressing and releasing the  button or decreased by pressing and releasing the  button.

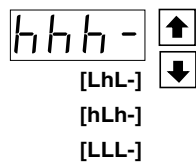

When the  and  buttons are shown with two displays, either display can be selected by pressing and releasing the  or  buttons.



When there are more than two display selections they are shown in brackets below the first display and are also selectable by pressing and releasing the  or  buttons.

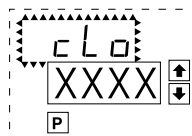

A dotted box indicates these functions are omitted or bypassed when the related hardware is not present

The BL-40PSF-ACA and BL-40PSF-ACV are intelligent meters with a hierarchical software structure designed for easy programming and operation, as shown below in the software logic tree.

After the meter has been powered up, the four digits light up for three seconds and then settle to the operational display indicating the input signal.

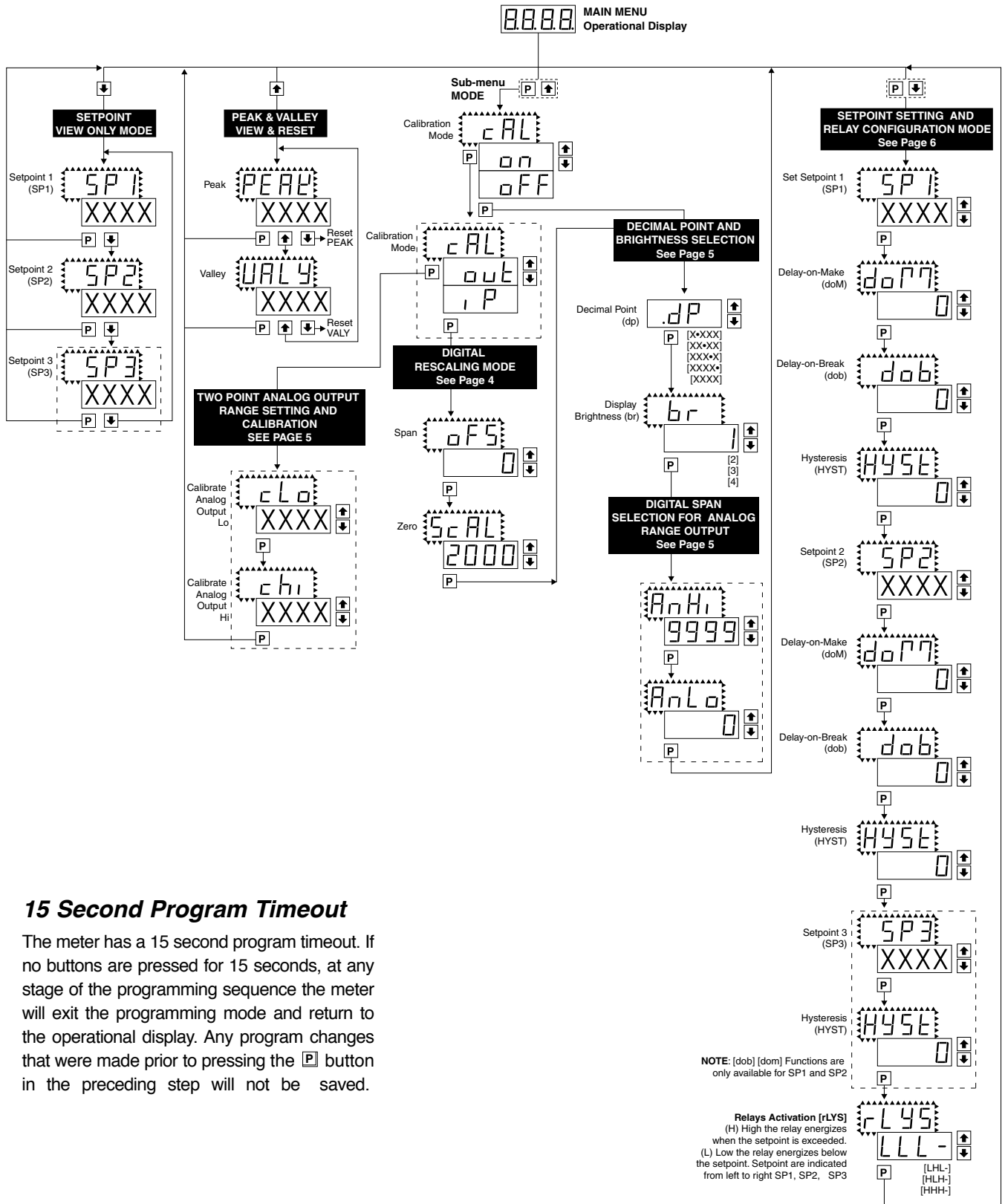

15 Second Program Timeout

The meter has a 15 second program timeout. If no buttons are pressed for 15 seconds, at any stage of the programming sequence the meter will exit the programming mode and return to the operational display. Any program changes that were made prior to pressing the **[P]** button in the preceding step will not be saved.

Digital Rescaling

The BL-40-ACA and BL-40-ACV meters may be rescaled without applying an external signal by changing the Offset and Scale factor.

Offset is the reading that the meter will display for a zero input. The Offset may be set to any value from -1999 to +9999. The default value of the Offset is 0

Scale factor is the gain of the meter. The displayed reading is directly proportional to the Scale factor. The default value of the scale factor is 1000, but it may be set to any value between -1999 and +9999.

For an input of 5A a calibrated meter will read 1000 with the default Scale factor of 1000, 3000 with a Scale factor of 3000 and 500 with a Scale factor of 500

If a linear scale is represented by $mx + b$, then the Scale Factor corresponds to the slope 'm' and the Offset corresponds to the intercept 'b'

Digital Rescaling Procedure

STEP A Enter the Calibration Mode

- 1) Press the **[P]** and **[↑]** buttons at the same time. Display toggles between [cAL] and [oFF].
- 2) Press the **[↑]** or **[↓]** button. Display changes from [oFF] to [on].
- 3) Press the **[P]** button. Display toggles between [cAL] and [out].

STEP B Select Between Calibration of Input or Output

Note: If the analog output option is not present, Step B is skipped and the program goes directly from Step A to Step C.

- 1) Press the **[↑]** or **[↓]** button to select the display toggling from [cAL] to [iP].
- 2) Press the **[P]** button. Display toggles between [oFFS] and the previous offset setting.

STEP C Set the Offset on the Digital Display

- 1) Using the **[↑]** and **[↓]** buttons, adjust the digital display to the desired offset. This is the reading that the meter will display for a zero input
- 2) Press the **[P]** button. Display toggles between [ScAL] and the previous Scale factor.

STEP D Set the Scale factor on the Digital Display

- 1) Using the **[↑]** and **[↓]** buttons, adjust the meter display to the desired Scale factor. The default value is 2000, for which a 2V input will read 2000. If the scale factor is changed the display will change proportionately. Therefore if the Scale factor is changed to 1000 then for the same 2V input the display would read 1000.
- 3) Press the **[P]** button.

The Digital Calibration Procedure Mode is Now Complete.

The menu branches to the DECIMAL POINT AND BRIGHTNESS SELECTION, (see page 5) and the display flashes [dP] and the previous decimal point selection.

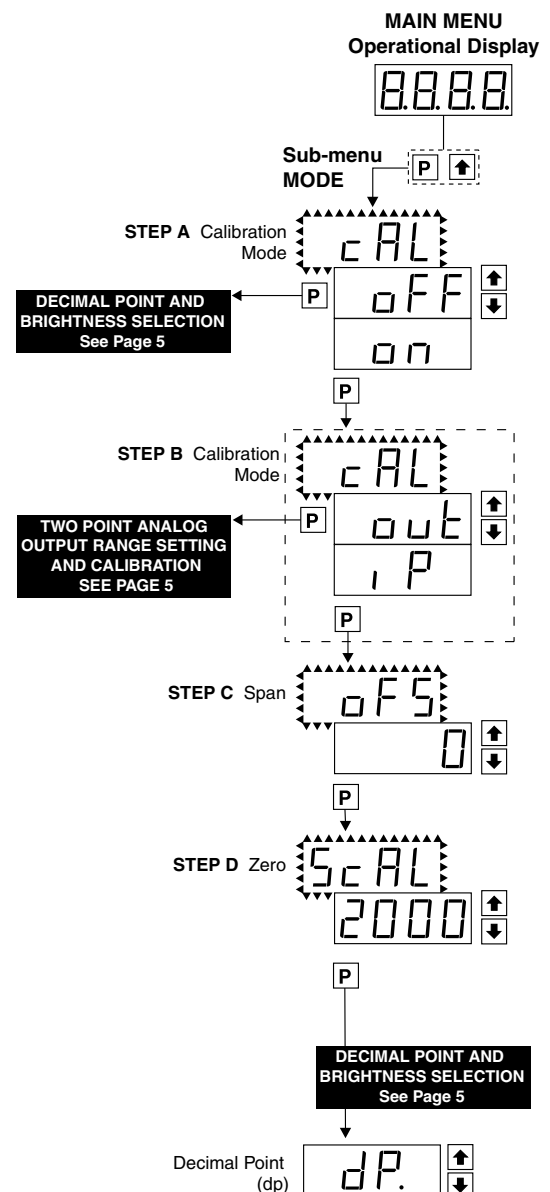

Two Point Analog Output Range Setting and Calibration

STEP A Enter the Calibration Mode

- 1) Press the **P** and **↑** buttons at the same time. Display toggles between [cAL] and [oFF].
- 2) Press the **↑** or **↓** button. Display changes from [oFF] to [on].
- 3) Press the **P** button. Display toggles between [cAL] and [out] input calibration.

Note: If at this point the display skips directly to toggle between [SPAn] and the previous [SPAn], the software is detecting that the optional analog output hardware is NOT installed.

STEP B Enter the Analog [oUT] Output Mode

- 1) Press the **P** button. Display toggles between [cLo] and an internal scale factor.

STEP C Set or Calibrate the [cLo] Low Analog Output Range

- 1) Select the voltage or current loop output header position on the output module. (See Component Layout on page 9).
- 2) Connect a multimeter to pins 8 and 9 on the output module. (See Rear Panel Pinouts on page 8). Using the **↑** and **↓** buttons, adjust the analog output to the desired low value as shown on the multimeter display. CLo may be adjusted to any value from -0.3 mA to 17 mA (mA output selected) or from -0.6 V to 8 V (volt output selected)
- 3) Press the **P** button. Display toggles between [Chi] and an internal scale factor.

STEP D Set or Calibrate the [chi] High Analog Output Range

- 1) Using the **↑** and **↓** buttons, adjust the analog output to the desired high value as shown on the multimeter display. chi may be adjusted to any value from 17 mA to 21 mA (mA output selected) or from 8 V to 10.3 V (volt output selected)
- 2) Press the **P** button. The display exits the calibration mode and returns to the operational display.

Note: Having established the Low and High range of the analog output, the digital span can now be selected which will set the two digital points between which the analog output will occur. (See Digital Span Selection below).

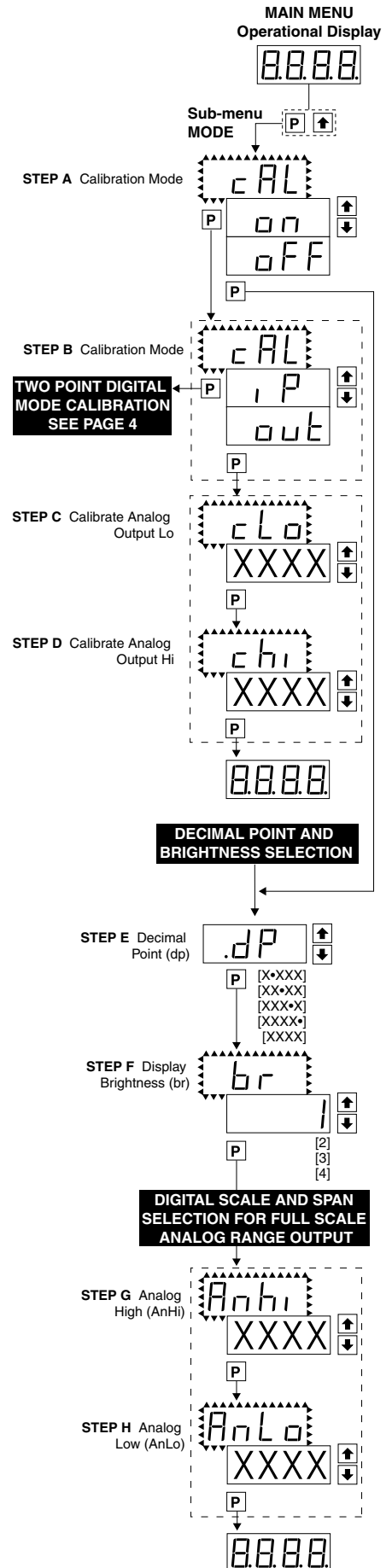

Decimal Point and Brightness Selection

STEP A Enter the Decimal Point and Brightness Mode Through the Sub Menu [cAL] [oFF]

- 1) Press the **P** and **↑** buttons at the same time. Display toggles between [cAL] and [oFF].
- 2) Press the **P** button. Display shows previous [dp] selection.

STEP E Set the Decimal Point

- 1) Using the **↑** and **↓**, adjust the display to the desired decimal point setting.
- 2) Press the **P** button. Display toggles between [Br] and the previous [Br] setting.

STEP F Set the Display Brightness

- 1) Using the **↑** and **↓** buttons, adjust the display to the desired brightness setting (4 is the brightest setting).
- 2) Press the **P** button. Display brightness changes to new setting and display toggles between [AnHi] and the previous [AnHi] setting.

Digital Span Selection for Analog Range Output

STEP G Setting the Digital Span Point for Analog High Output

- 1) Using the **↑** and **↓** buttons, adjust the display to the desired digital value which sets the point at which the selected analog high output range will occur.
- 2) Press the **P** button. Display toggles between [AnLo] and previous [AnLo] setting.

STEP H Setting the Digital Span Point for Analog Low Output

- 1) Using the **↑** and **↓** buttons, adjust the display to the desired digital value which sets the point at which the selected analog low output range will occur.
- 2) Press the **P** button. The display exits the calibration mode and returns to the operational display.

Note: Any two digital scale points from -1999 to 9999 can be selected. The digital scale points for analog high and analog low can be reversed for reversed 20-4 mA output. The span of the digital scale can be as small as two counts however small spans cause the 16 bit D to A to increment in stair case steps.

Setpoint Setting and Relay Configuration Mode

The following programming steps are required to enter the setpoint values and configure the relay functions in a meter with four relays using four setpoints. Generally if less than four relays are installed the software auto detects missing relays and deletes reference to them from the menu. In some cases setpoints without relays are operational for display only purposes.

STEP A Enter the Setpoint Mode

- 1) Press the **[P]** and **[↓]** buttons at the same time.
Display toggles between [SP1] and the previous [SP1] setting.

STEP B Set Setpoint 1 (SP1)

- 1) Using the **[↑]** and **[↓]** buttons, adjust the display to the desired SP1 value.
- 2) Press the **[P]** button. Display toggles between [doM] and the previous [doM] setting.

STEP C Set the SP1 Delay-on-Make (doM) Delay Time Setting

- 1) Using the **[↑]** and **[↓]** buttons, adjust the display to the desired [doM] value (0 to 9999 seconds). The reading must continuously remain in an alarm condition until this delay time has elapsed before the relay will make contact (energize).
- 2) Press the **[P]** button. Display toggles between [dob] and the previous [dob] setting.

STEP D Set the SP1 Delay-on-Break (dob) Delay Time Setting

- 1) Using the **[↑]** and **[↓]** buttons, adjust the display to the desired [dob] value (0 to 9999 seconds). The reading must continuously remain in a non-alarm condition until this delay time has elapsed before the relay will break contact (de-energize).
- 2) Press the **[P]** button. Display toggles between [HYSt] and the previous [HYSt] setting.

STEP E Set the Hysteresis Setting for Setpoint 1

- 1) Using the **[↑]** and **[↓]** buttons, adjust the display to the desired hysteresis [HYSt] value.
 - 2) Press the **[P]** button. Display toggles between [SP2] and the previous [SP2] setting.
- NOTE:** Half of the Hysteresis value selected is applied above and below the setpoint.

NOTE: Steps F, G, H and J have functionally the same procedure as steps B, C, D, and E shown above.

STEP F Set Setpoint 2 (SP2)

STEP G Set the SP2 Delay-on-Make (doM) Delay Time Setting

STEP H Set the SP2 Delay-on-Break (dob) Delay Time Setting

STEP I Set the Hysteresis Setting for Setpoint 2

- 1) Using the **[↑]** and **[↓]** buttons, adjust the display to the desired hysteresis [HYSt] value.
- 2) Press the **[P]** button. Display toggles between [SP3] and the previous [SP3] setting.

STEP J Set Setpoint 3 (SP3) (No [doM] or [dob])

- 1) Using the **[↑]** and **[↓]** buttons, adjust the display to the desired SP3 value.
- 2) Press the **[P]** button. Display toggles between [HYSt] and the previous [HYSt] setting.

STEP K Set the Hysteresis Setting for Setpoint 3

- 1) Using the **[↑]** and **[↓]** buttons, adjust the display to the desired hysteresis [HYSt] value.
- 2) Press the **[P]** button. Display toggles between [rLYS] and the previous relay setting.

STEP N Set Relay Activation mode [rLYS]

(H) High the relay energizes when the setpoint is exceeded. (L) Low the relay energizes below the setpoint. The setpoint is indicated from left to right SP1, SP2, and SP3.

- 1) Using the **[↑]** and **[↓]** buttons, adjust the reading on the display to the desired relay settings: [LLL-], [LHL-], [LLH-], [HHH-].
If only 2 relays installed [LH] [HL] [HH] [LL].
- 2) Press the **[P]** button.
The meter exits the setpoint mode and returns to the operational display.

The Setpoint Relay programming mode is now complete.

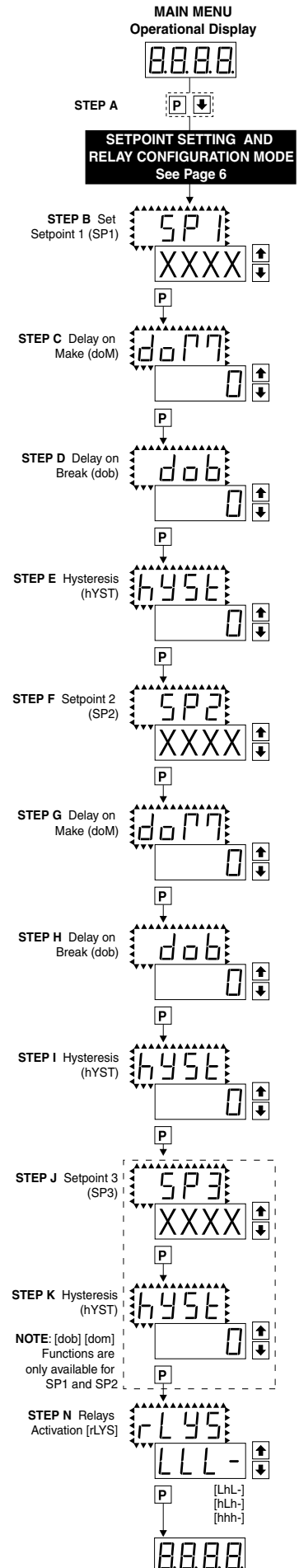

Connector Pinouts

This meter comes standard with screw terminal plug connections.

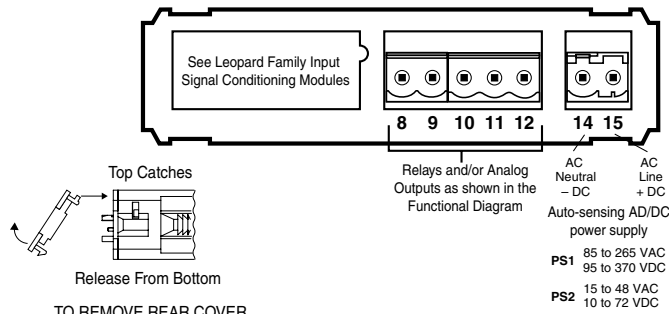

TO REMOVE REAR COVER

- To Remove meter from case,
1. Release Catch from Bottom
 2. Remove Rear cover
 3. Slide Meter out with caution

Connectors

This meter uses plug-in type screw terminal connectors for all input and output connections. The power supply connections (pins 14 and 15) have a unique plug and socket outline to prevent cross connection. The main board uses standard right-angled connectors.

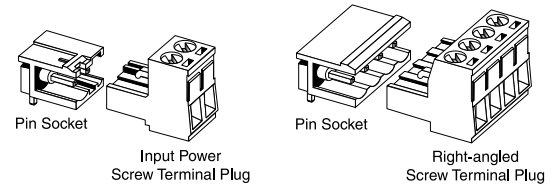

WARNING: AC and DC input signals and power supply voltages can be hazardous. Do Not connect live wires to screw terminal plugs, and do not insert, remove or handle screw terminal plugs with live wires connected.

Pin Descriptions

Pins 1 and 2 – Input Signal

Pins 1 and 2 are reserved for the input signal conditioner. See the data sheet for the selected input signal conditioner.

Pins 8 to 12 – Relay and Analog Output Pins

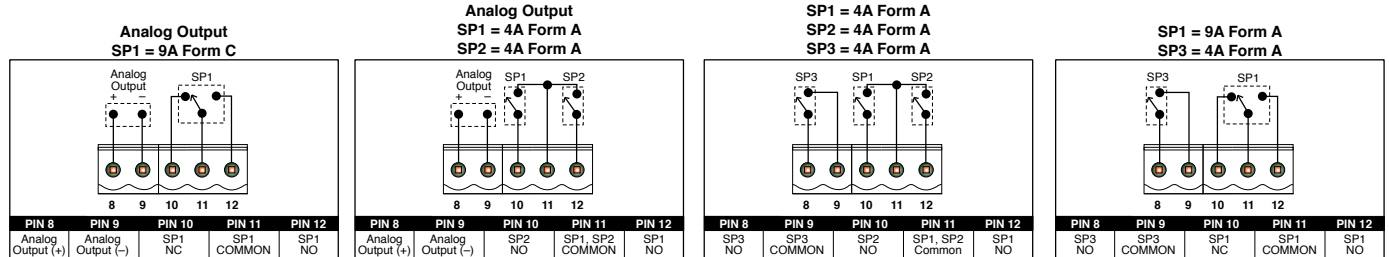

Pins 14 and 15 – AC/DC Power Input

Auto sensing AC/DC power supply. For voltages between 85-265 VAC or 95-300 VDC (PS1).

Pin 14 & Pin 15 - AC/DC Power Input: These pins are the power pins of the meter and they only accept a special polarized screw terminal plug that can not be inserted into any other input socket. The standard meter has a auto sensing AC/DC power supply that operates from 85-265 VAC/95-300 VDC (PS1 Std). An optional isolated low voltage power supply that operates from 15-48 VAC/10-72 VDC (PS2) is also available.

Installation Guidelines

Installation

1. Install and wire meter per local applicable codes/regulations, the particular application, and good installation practices.
2. Install meter in a location that does not exceed the maximum operating temperature and that provides good air circulation.
3. Separate input/output leads from power lines to protect the meter from external noise. Input/output leads should be routed as far away as possible from contactors, control relays, transformers and other noisy components. Shielding cables for input/output leads is recommended with shield connection to earth ground near the meter preferred.
4. A circuit breaker or disconnect switch is required to disconnect power to the meter. The breaker/switch should be in close proximity to the meter and marked

as the disconnecting device for the meter or meter circuit. The circuit breaker or wall switch must be rated for the applied voltage (e.g., 120VAC or 240VAC) and current appropriate for the electrical application (e.g., 15A or 20A).

5. See *Case Dimensions* section for panel cutout information.

6. See *Connector Pinouts* section for wiring.

7. Use 28-12 AWG wiring, minimum 90°C (HH) temperature rating. Strip wire approximately 0.3 in. (7-8 mm).

8. Recommended torque on all terminal plug screws is 4.5 lb-in (0.51 N-m).



Component Layout

MAIN BOARD

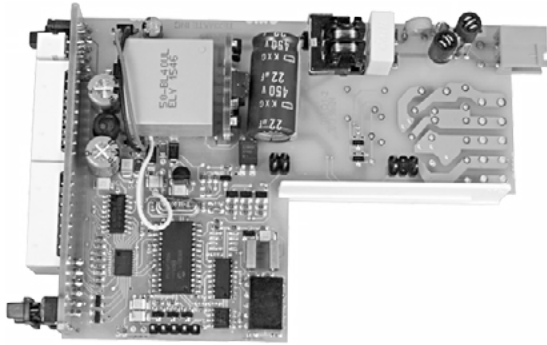

MAIN BOARD HI BOLTAGE

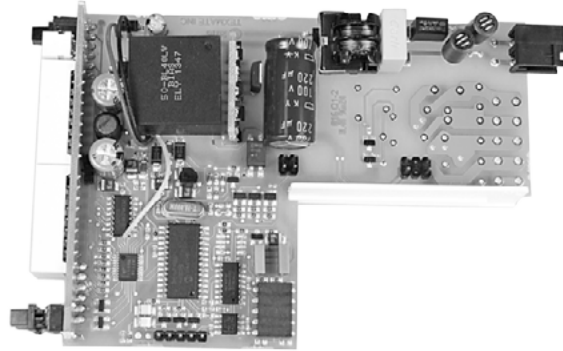

MAIN BOARD LOW BOLTAGE

AC VOLTS INPUT MODULE

IA01 AC-Volts Scaled RMS, 200/300V AC

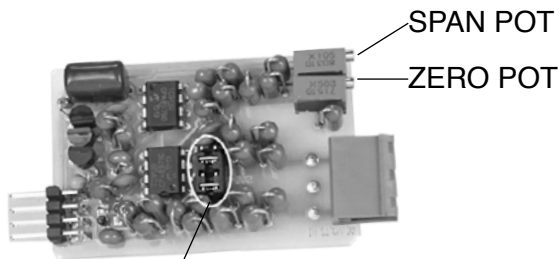

INPUT RANGE HEADER

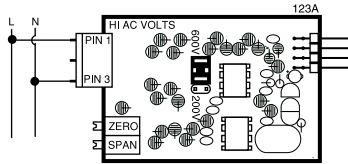

IA06 AC-Volts True RMS, 200/300V AC

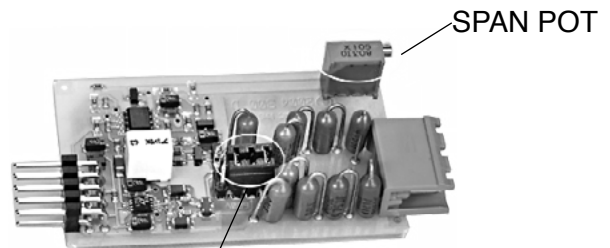

INPUT RANGE HEADER

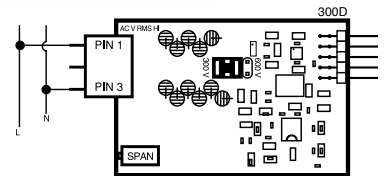

AC AMPS INPUT MODULE

IA05 AC-Amps Scaled RMS

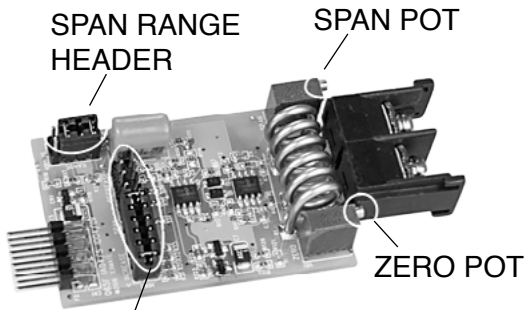

SPAN ADJUST HEADER

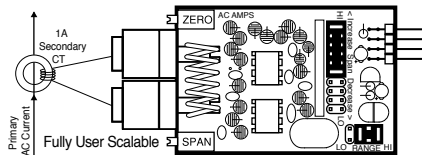

IA11 AC-Amps True RMS

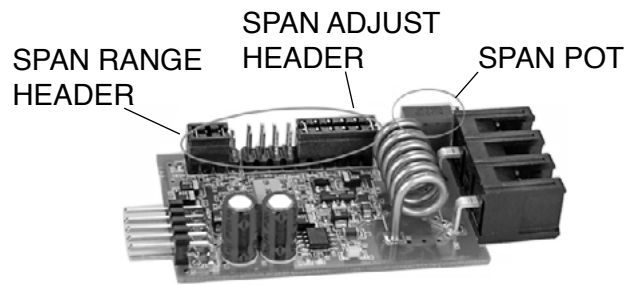

SPAN RANGE HEADER

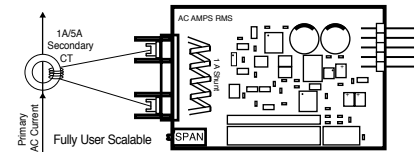

Program Lockout Header

This header disable any programming function.



To access the header, you must remove meter from case. Please see "Connector Pinouts" on page 7 for the instruction.

Input Module Component Glossary

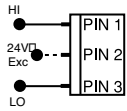

Input and Output Pins

On most modules Pin 1 is the Signal High input and Pin 3 is the Signal Low input. Typically Pin 2 is used for Excitation Voltage output.



SPAN Potentiometer (Pot)

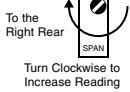

If provided, the 15 turn SPAN pot is always on the right side (as viewed from the rear of the meter). Typical adjustment is 20% of the input signal range.

SPAN ADJUST Header

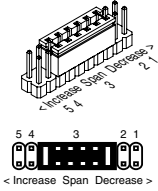

This unique five-position header expands the adjustment range of the SPAN pot into five equal 20% steps, across 100% of the input Signal Span. Any input Signal Span can then be precisely scaled down to provide any required Digital Display span from 1999 counts to 001 (one count).

SPAN Adjust Header position	1	2	3	4	5
SPAN Pot %	20%	20%	20%	20%	20%
Signal Span %	20%	40%	60%	80%	100%

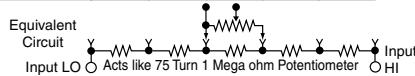

SPAN RANGE Header

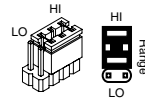

When this header is provided it works in conjunction with the SPAN ADJUST Header by splitting its adjustment range into a Hi and a Lo range. This has the effect of dividing the adjustment range of the SPAN pot into ten equal 10% steps across 100% of the input Signal Span.

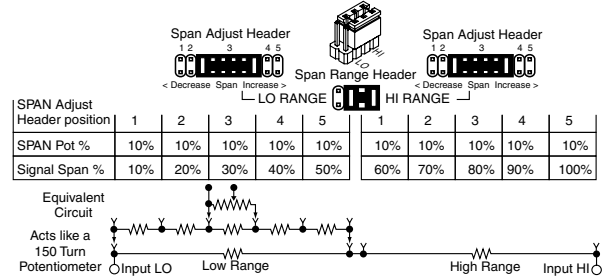

ZERO Potentiometer (Pot)

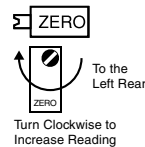

If provided, the ZERO pot is always to the left of the SPAN pot (as viewed from the rear of the meter). Typically it enables the input signal to be offset $\pm 5\%$ of full scale (-100 to +100 counts).



Case Dimensions

PANEL CUTOUT

Case will mount in standard 1/16 DIN cutouts

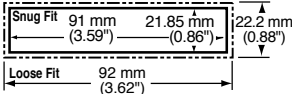

Panel adaptor plates are available to retrofit most existing panel cutouts.

FRONT VIEW

1/16 DIN (96x24mm)

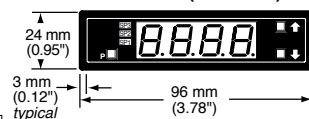

SIDE VIEW

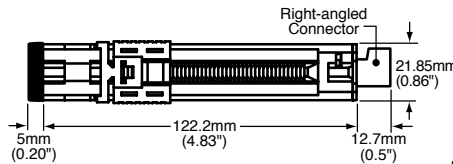

TO REMOVE REAR COVER

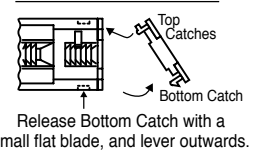

TOP VIEW

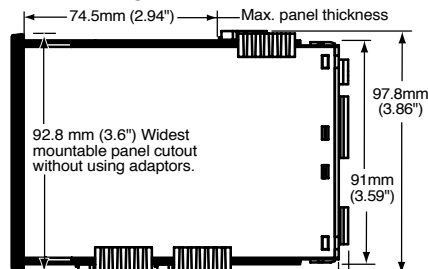

For additional strength, extra Mounting Slide Clips can be ordered and doubled up one behind the other. P/N:(75-DMT96X24)

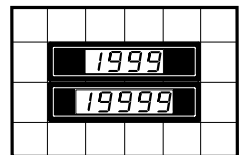

The 96x24mm case is particularly suitable for mounting in mosaic panels or insulative panels up to 2" thick. They can also stack mount, 2 up in existing cut-outs for 1/8 DIN (96x48mm) or 4 up in 1/4 DIN (96x96mm).

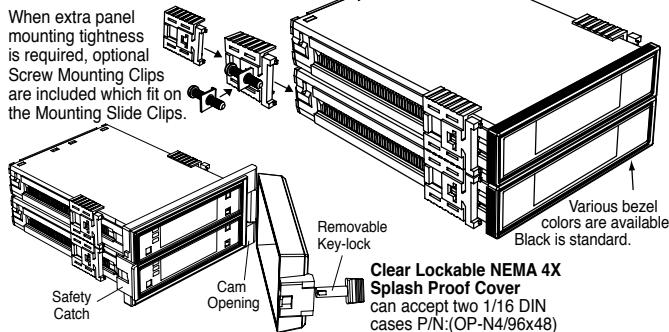

Ordering Information

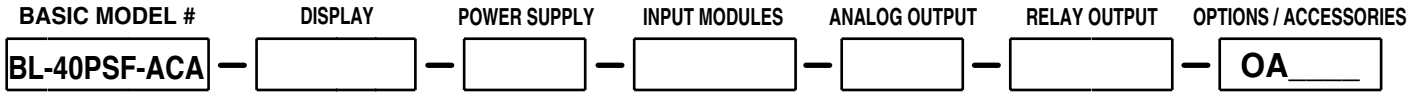

Add to the basic model number the order code suffix for each standard option required. The last suffix is to indicate how many different special options and or accessories that you may require to be included with this product.

Ordering Example: BL-40PSF-ACA-DR-PS1-IA01-OIC-R1-OA2, the 2 OA's are, ZR and a 75-DMT96X24

► BASIC MODEL NUMBER

- BL-40PSF-ACA 96x24mm, Leopard, 4 Digit, AC Amps
- BL-40PSF-ACV 96x24mm, Leopard, 4 Digit, AC Volts

Standard Options for this Model Number

Order Code Suffix	Description	List
-------------------	-------------	------

► DISPLAY

- DR Red LED, 0.56 inch high.
- DB Super-bright Red LED, 0.56 inch high.
- DG Green LED, 0.56 inch high.

► POWER SUPPLY

- PS1 85 - 265VAC / 95 - 300VDC
- PS2 18 - 48VAC / 10 - 72VDC

► INPUT MODULES (Partial List. See www.texmate.com)

Unless otherwise specified Texmate will ship all modules precalibrated with factory preselected ranges and/or scalings as shown in **BOLD** type.

For BL-40PSF-ACA

- IA05 . . AC-Amps Scaled RMS, **0-5 Amp AC (0-100.00)**
- IA11 . . AC-Amps True RMS, **0-5 Amp AC (0-100.00)**

For BL-40PSF-ACV

- IA01 . . AC-Volts Scaled RMS, 200/**300V** AC
- IA06 . . AC-Volts True RMS, 200/**300V** AC

► ANALOG OUTPUT*

- OIC . . . Isolated analog 4-20mA (with a Max. Two-5A Form A Relays) . . .
 - OIV . . . Isolated analog 0-10VDC (with a Max. Two-5A Form A Relays) . . .
- *Note: When either of the Analog Output options is installed, only the R1, R2 and R11 Relay Output options can be co-installed (see below).

► RELAY OUTPUT

- R1 Single 5A Form A Relay
 - R2 Dual 5A Form A Relays
 - R3 Three 5A Form A Relays; SP1 & SP2 common**
 - R11 . . . Single 10A Form C Relay
 - R16 . . . Single 10A Form C & Single 5A Form A Relays**
- **R3 & R16 cannot be co-installed with Analog Output options.

Special Options and Accessories (OA's)

Part Number	Description	List
-------------	-------------	------

► SPECIAL OPTIONS (Specify Inputs or Outputs & Req. Reading)

- ZR Range Change from Standard Range shown in **BOLD** type
- ZS Custom display scaling within standard ranges . . .
- ZS-AO Custom scaling of analog output

► ACCESSORIES

- 75-DBBZ96X24 Black Bezel for 96x24mm Case
- 75-DMTC96X24 Side Slide Brackets (2 pc) - extra set, extra strength . .
- ART-FS-S/D NRC for artwork & set-up Faceplate/Desc.
- ART-FS1 Install Custom Faceplate per meter - 1 color
- 93-PLUG2P-DP Extra Screw Terminal Conn., 2 Pin Power Plug . .
- 93-PLUG2P-DR Extra Screw Terminal Conn., 2 Pin Plug
- 93-PLUG3P-DR Extra Screw Terminal Conn., 3 Pin Plug
- 93-PLUG4P-DR Extra Screw Terminal Conn., 4 Pin Plug
- DN.CAS96X24L Complete 96x24mm Case with bezel.
- OP-MTLCLIP Screw Mounting Clips (2 pc) to screw tighten slide brackets
- 75-DTP96X24 Black Metal Trim Plate (96x24mm Case) 1 Meter . .
- 75-DTP2X9624. Black Metal Trim Plate (96x24mm Case) 2 Meters . .
- 75-DTP3X9624. Black Metal Trim Plate (96x24mm Case) 3 Meters . .
- OP-PMA/SWB-2 Switch Board Panel Mounting Adapter 2 Meters . .
- OP-PMA/SWB-2 Switch Board Panel Mounting Adapter 3 Meters . .

Many other options and accessories are available. See full price list for more details.

Prices subject to change without notice.

WARRANTY

Texmate warrants that its products are free from defects in material and workmanship under normal use and service for a period of one year from date of shipment. Texmate's obligations under this warranty are limited to replacement or repair, at its option, at its factory, of any of the products which shall, within the applicable period after shipment, be returned to Texmate's facility, transportation charges pre-paid, and which are, after examination, disclosed to the satisfaction of Texmate to be thus defective. The warranty shall not apply to any equipment which shall have been repaired or altered, except by Texmate, or which shall have been subjected to misuse, negligence, or accident. In no case shall Texmate's liability exceed the original purchase price. The aforementioned provisions do not extend the original warranty period of any product which has been either repaired or replaced by Texmate.

USER'S RESPONSIBILITY

We are pleased to offer suggestions on the use of our various products either by way of printed matter or through direct contact with our sales/application engineering staff. However, since we have no control over the use of our products once they are shipped, **NO WARRANTY WHETHER OF MERCHANTABILITY, FITNESS FOR PURPOSE, OR OTHERWISE** is made beyond the repair, replacement, or refund of purchase price at the sole discretion of Texmate. Users shall determine the suitability of the product for the intended application before using, and the users assume all risk and liability whatsoever in connection therewith, regardless of any of our suggestions or statements as to application or construction. In no event shall Texmate's liability, in law or otherwise, be in excess of the purchase price of the product.

Texmate cannot assume responsibility for any circuitry described. No circuit patent or software licenses are implied. Texmate reserves the right to change circuitry, operating software, specifications, and prices without notice at any time.



1934 Kellogg Ave., Carlsbad, CA 92008
 Tel: 1-760-598-9899 • 1-800-TEXMATE
 Fax: 1-760-598-9828 • Email: orders@texmate.com

BL-40PSF-ACA, BL-40PSF-ACV Technical Manual Copyright © 2019 Texmate Inc. All rights reserved. Published by: Texmate Inc. USA. Information in this Technical Manual is subject to change without notice due to correction or enhancement. The information described in this manual is proprietary to Texmate, Inc. and may not be copied, reproduced or transmitted, in whole or in part, in connection with the design, manufacture, or sale of apparatus, device or private label product without the express written consent of Texmate, Inc.