

This document is designed to supplement the information on the meter's programmable setpoints and optional relay output modules described in the Tiger 320 Series user manual.

Associated Documents

The following documents must be read together with this supplement:

Relevant Tiger 320 Series User Manual

The users manual provides general information on the relevant Tiger 320 Series meter.

Tiger 320 Series Programming Code Sheet (NZ101)

The programming code sheet provides all meter programming codes including setpoint programming codes.

Registers Supplement (NZ209)

This supplement provides a detailed list of all registers available for setpoint source activation and reset functions.

Advanced Calibration & On Demand Mode Supplement (NZ203)

This supplement provides detailed descriptions on all calibration related topics.



Programming Tip

This document has been written using a DI-50 7-segment, 5-digit display meter. When programming meters with other display options, some display readings may vary to the diagrams shown.



Note:

All examples used throughout this document are for relays with **NORMALLY OPEN** contacts.

General Notices & Tips

The range of Tiger 320 Series supplements contain three graphic symbols to aid you:



WARNING Symbol

The WARNING symbol is generic to all Tiger 320 Series documents and indicates that if the instruction is not heeded, the action may result in loss of life or serious injury.



NOTE Symbol

The NOTE symbol is generic to all Tiger 320 Series user manual supplements and indicates important or helpful information on the topic being discussed.



PROGRAMMING TIP Symbol

The programming tip symbol is generic to all Tiger 320 Series documents and indicates useful tips when programming the instrument.

Definitions

The following definitions are relevant to this document:

X

If an X appears in the description of a 3-digit programming code or in a configuration procedure, this means that any number displayed in that digit is not relevant to the function being explained, or more than one choice can be made.

Meter – Controller

The term meter, as used throughout this document, is a generic term for all Tiger 320 Series signal processors and controllers

Table of Contents

Setpoint Functional Overview

<i>Technical Specifications</i>	8
<i>Technical Description</i>	9
<i>Setpoint Programming Mode</i>	11
Setpoint Activation Values Mode	11
Setpoint and Relay Control Settings Mode	11
Electromechanical Relays	13
<i>Relay Options</i>	13
Solid State Relays	14
Opto-isolators	15
Relay Options	15
GI-50 & GI-50B101 Meter Relays	16
FI-B101D50 Bargraph Relays	16

Level 1 – Basic Mode

<i>Level 1 – Relay and Setpoint Configuration Sequence</i>	18
<i>Level 1 – Functions</i>	20
Level 1 – 2nd Digit: Setpoint Activation Source	20
Level 1 – 1st Digit: Relay Energize Functions	20
Level 1 – 3rd Digit: Latching and Reset	21
<i>Level 1 – Example Configuration Procedures</i>	23
Example – Setpoint Activation Values	23
Example – Setpoint Control Settings	23
LEVEL 1 – Setpoint Activation Values: Example Procedure	24
LEVEL 1 – Relay Energize, Latching, & SP Activation Source: Example Procedure	25

Level 2 – Intermediate Mode

<i>Level 2 – Relay and Setpoint Configuration Sequence</i>	28
<i>Level 2 – Functions</i>	30
Level 2 – 1st Digit: Relay Energize Functions	30
Level 2 – 3rd Digit: Hysteresis, Deviation, and PID	31
Level 2 – 3rd Digit: Latching and Reset	31
Level 2 – 2nd Digit: Setpoint Activation Source	31
Level 2 – 3rd Digit: Timers	38
Example – Setpoint Activation Values	45
Example – Setpoint Control Settings	45
<i>Level 2 – Example Configuration Procedures</i>	45
LEVEL 2 – Hysteresis Mode: Example Procedure	46
LEVEL 2 – PID Mode: Example Procedure	48
LEVEL 2 – Timer Mode: Example Procedure	50
LEVEL 2 – Select Setpoint Activation Source: Example Procedure	51

Level 3 – Advanced Mode

<i>Level 3 – Relay and Setpoint Configuration Sequence</i>	54
<i>Level 3 – Functions</i>	56
Level 3 – 1st Digit: Relay Energize Functions	56
Level 3 – 3rd Digit: Latching and Reset	56
Level 3 – 2nd Digit: Setpoint Activation Source	56
Level 3 – 3rd Digit: Advanced Functions Mode	57
Level 3 – 3rd Digit: Hysteresis, Deviation, PID, & Timers	57
Example – Setpoint Activation Source	60
Example – Setpoint Control Settings	60

<i>Level 3 – Example Configuration Procedures</i>	60
---	----

LEVEL 3 – Advanced Reset and Trigger Functions : Example Procedure	62
---	----

Other Setpoint Related Functions

<i>Data Logging & Data Printing from a Setpoint</i>	68
Setpoint Time Control and Logging	68
Data Printing from a Setpoint to a Serial Printer or PC	68
Data Logging from a Setpoint	68
Local Distributor Address.....	72

List of Figures

<i>Figure 1 – Setpoint Mode Functional Block Diagram</i>	10
<i>Figure 2 – Meter Programming Digits for Setpoint and Relay Control Functions</i>	11
<i>Figure 3 – Setpoint Programming Mode Logic Diagram</i>	12
<i>Figure 4 – Tiger 320 Series Relay Options</i>	15
<i>Figure 5 – NO Latching</i>	22
<i>Figure 6 – Setpoint Latching</i>	22
<i>Figure 7 – Manual Relay Reset</i>	22
<i>Figure 8 – Latching & Manual Relay Reset</i>	23
<i>Figure 9 – Latched OFF</i>	23
<i>Figure 10 – Example 1: Relay energize functions without hysteresis or deviation</i>	30
<i>Figure 11 – Hysteresis Delay</i>	32
<i>Figure 12 – Example 1: Relay energize functions with hysteresis</i>	33
<i>Figure 13 – Deviation Delay</i>	34
<i>Figure 14 – Example 2: Relay energize functions with deviation</i>	35
<i>Figure 15 – PID Controls</i>	35
<i>Figure 16 – PID Control Settings</i>	36
<i>Figure 17 – Examples 3 and 4: PID mode with the relay energized above and below SP</i>	36
<i>Figure 18 – Example of Setpoint Tracking</i>	37
<i>Figure 19 – Normal Mode</i>	39
<i>Figure 20 – NORMAL Mode Time Control</i>	39
<i>Figure 21 – Repeat ON Mode</i>	40
<i>Figure 22 – REPEAT ON Mode Time Control</i>	40
<i>Figure 23 – Pulse ON Mode</i>	41
<i>Figure 24 – PULSE ON Mode Time Control</i>	41
<i>Figure 25 – I-Shot ON Mode</i>	41
<i>Figure 26 – I-SHOT ON Mode Time Control</i>	42
<i>Figure 27 – I-Shot OFF Mode</i>	42
<i>Figure 28 – I-Shot OFF Mode Time Control</i>	42
<i>Figure 29 – Pulse OFF Mode</i>	43
<i>Figure 30 – PULSE OFF Mode Time Control</i>	43
<i>Figure 31 – Repeat OFF Mode</i>	43
<i>Figure 32 – REPEAT OFF Mode Time Control</i>	44
<i>Figure 33 – Make Edge Mode</i>	58
<i>Figure 34 – Break Edge Mode</i>	58
<i>Figure 35 – Both Edges Mode</i>	59
<i>Figure 36 – Level Mode</i>	59

This Page intentionally left blank

Setpoint Functional Overview

The Tiger 320 Series signal processor and controller has six setpoints individually programmable to operate within the total span range of the meter and the selected input module. A relay output module provides the instrument with up to six relay outputs using a combination of 5 amp Form A and 10 amp Form C, or 5 volt solid state relays (SSRs).

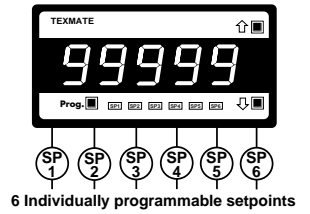

See *Relay Options* for further details.

All six setpoints are available for relay activation or internal control functions such as register reset and counting functions. Each setpoint can be individually programmed to energize a relay or reset a register. The setpoint can be activated from any input channel, a selected register, or from the rear input pins.

All six setpoints are individually programmable for sophisticated time control applications using the following features.

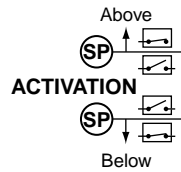

Relay Energize Functions

All setpoints activate at the setpoint value. All relays/setpoints are programmable to energize above or below the setpoint value.

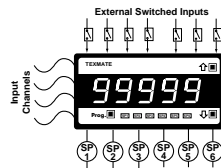

Setpoint Activation Source

Setpoints activate from any input channel, selected meter register, or external switched inputs (digital input pins).

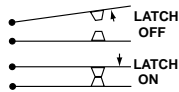

Setpoint Latching

Setpoints can be programmed in relay latching modes.

- SP TRIGGER OPERATES ON:
 - MAKE EDGE
 - BREAK EDGE
 - MAKE & BREAK EDGE
 - EVERY SAMPLE PERIOD
- SP RESET SELECTED REGISTER
- SP TRIGGER PRINT
- SP TRIGGER LOG DATA

Setpoint Reset

Setpoints can be programmed to reset selected registers, or be manually reset.



Setpoint Tracking

Any setpoint can be programmed to track any other setpoint.

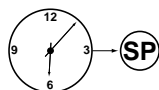

Real-time Clock Option

Any setpoint can be programmed to operate from the real-time clock option.

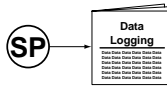

Data Logging

Any setpoint can be programmed to log data within the meter (up to 4000 samples).

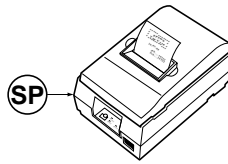

Data Printing to Serial Printer

Any setpoint can be programmed to send data directly to a serial printer.

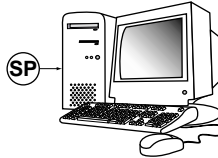

Data Printing to PC

Any setpoint can be programmed to send data directly to a connected PC.

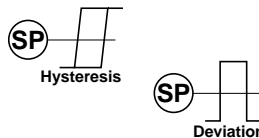

Hysteresis or Deviation

Each relay can operate in a hysteresis or deviation mode.

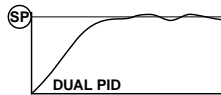

PID

Relays 1 and 2 can be programmed for PID operation.

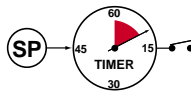

Timer Control Modes

Each setpoint can be programmed to operate the relay in one of the following seven resident time control modes:

Normal Mode Timer

Single actuation, delay-on-make (DOM) and delay-on-break (DOB).

Normally OFF/Pulsed ON Timers

Repeat ON Mode Timer – multiple actuation, programmable off-and on-time.

Pulse ON Mode Timer – single actuation, programmable DOM and maximum on-time.

1-Shot ON Mode Timer – single actuation, programmable DOM and minimum on-time.

Normally ON/Pulsed OFF Timers

Repeat OFF Mode Timer – multiple actuation, programmable off-and on-time.

Pulse OFF Mode Timer – single actuation, programmable DOB and maximum off-time.

1-Shot OFF Mode Timer – single actuation, programmable DOB and minimum off-time.

Setpoint Activation Source

- Any analog input signal on any channel.
- Any digital input signal on any channel.
- Digital input pins at rear of meter.
- An external switch closure.
- Result of math performed on input signal.
- An internal register.
- Serial input.
- Setpoints tracking other setpoints.

Setpoint Activation Functions

- Activate ABOVE setpoint.
- Activate BELOW setpoint.
- Hysteresis.
- Deviation.
- Dual PID Control.
- Initial Start-up Inhibit.
- Window Comparator.

Setpoint Timer Modes

- **Normal Mode.** Delay-on-make (DOM), delay-on-break (DOB) settings.
- **Repeat ON Mode.** Programmable **on** and **off time** settings.
- **Pulse ON Mode.** Programmable **DOM** and **on time** settings.
- **1-Shot ON Mode.** Programmable **DOM** and **minimum on time** settings.
- **Repeat OFF Mode.** Programmable **off** and **on time** settings.
- **Pulse OFF Mode.** Programmable **off time** and **DOB**.
- **1-Shot OFF Mode.** Programmable **minimum off time** and **DOB** settings.

Setpoints & Relays

Setpoint Activation Results

- FLASH Display.
- Turn relay ON.
- Turn relay OFF.
- Latch relay ON.
- Latch relay OFF.
- Count setpoint activations.
- Reset any internal register.
- Increment any internal register.
- Activate another relay.
- Print any selected register contents.
- Turn ON front panel annunciators.
- Transfer contents of any register to another register.
- Log data to internal memory.
- Activate a custom macro.
- Send a pulse to an external device.
- Control PID output.

Setpoint Timer Results

- Single and multiple actuation, normally OFF / pulsed ON or normally ON / pulsed OFF modes.
- 0.001 second resolution settings for setpoints 1 and 2 in both PULSE and both REPEAT timer modes.
- 0.1 second resolution settings for setpoints 3 to 6 in all timer modes.
- Delay-on-make, Delay-on-break (Normal timer).
- Turn relay ON/OFF/ON/OFF (Repeat timer).
- Turn relay OFF/ON/OFF/ON (–Repeat timer).
- Pulse ON for guaranteed on-time (Pulse timer).
- Pulse OFF for guaranteed off-time (–Pulse timer).
- Stay ON for guaranteed minimum on-time (1Shot timer).
- Stay OFF for guaranteed minimum off-time (–1Shot timer).

Technical Specifications

Relay Types:	5 A, 240 VAC Form A, electromechanical relay.
	10 A, 240 VAC Form C, electromechanical relay.
	400 V, 210 mA DC, independent normally open solid state relay (SSR).
	400 V, 140 mA AC / DC, independent normally open SSR.

All Tiger 320 Series meters, except the FI-B101D50, can be configured with a maximum of six electromechanical or four solid state relays (SSRs) using one of the following relay output modules:

Relay Output Module 137: Maximum six 5 A, Form A relays grouped in three using a single common per group.

Relay Output Module 138: Maximum four relays. Two groups of one 5 A, Form A and one 10 A, Form C relays using a single common per group.

Relay Output Module 156: Maximum four 5 A, Form A isolated relays.

SSR Output Module 237: Maximum four independent 400 V, 210 mA DC SSRs.

SSR Output Module 241: Maximum four independent 400 V, 140 mA AC / DC SSRs.

GI & FI Meter Main Board: Maximum four relays. Two groups of one 10 A, Form C and one 5 A, Form A relays sharing a single common per group.

FI Meter Carrier Board: Maximum two independent 400 V, 210 mA DC SSRs.

For further information on relay options for individual meter types, see the specific meter user manual.

Each setpoint can be individually configured for basic to advanced operations in the following three levels. Each operational level is designed to provide only the required relevant setpoint and relay functions.

The modes at Level 2 and Level 3 can be set to OFF for each individual setpoint, ensuring that no other functions are programmed to influence the setup.

Figure 1 is a block diagram showing the functional blocks that comprise the setpoint mode.

Level 1 Setpoint & Relay Basic Mode

This is an easily programmable mode for users who require the following basic setpoint and relay functions:

First Digit – Relay Energize Functions

Relays programmed to energize above or below the setpoint value.

Second Digit – SP Activation Source

Setpoints programmed to activate from selectable meter registers or one of six external switched inputs.

Third Digit – Setpoint Latching

Relays programmed with latching and manual reset options.

Level 2 Setpoint & Relay Intermediate Mode

Level 2 uses all Level 1 functions and is further extended by the following programmable modes. The functionality of the relay energize functions are extended by allowing the relays to be programmed with or without initial start-up inhibit.



Programming Tip

If you do not require any of the functions in this mode, ensure it is set to:

mode OFF

Hysteresis, Deviation & PID Mode

This mode adds extra functionality to the basic mode by providing programmable hysteresis or deviation settings for all setpoints, or PID control from setpoints SP1 and SP2.



Programming Tip

If you do not require any of the functions in this mode, ensure it is set to:

timer OFF

Timer Modes

These modes add even more functionality to the basic and intermediate mode by providing each setpoint with a choice of one of seven resident programmable timers.

Level 3 Setpoint & Relay Advanced Mode



Programming Tip

If you do not require any of the functions in this mode, ensure it is set to:

trig OFF

Level 3 uses all Level 1 and Level 2 functions combined with reset and trigger functions to provide an extremely powerful advanced mode.

Level 3 enables you to program all setpoints individually for operations normally requiring sophisticated controllers.

BLOCK DIAGRAM

SETPOINTS SP1 – SP 6

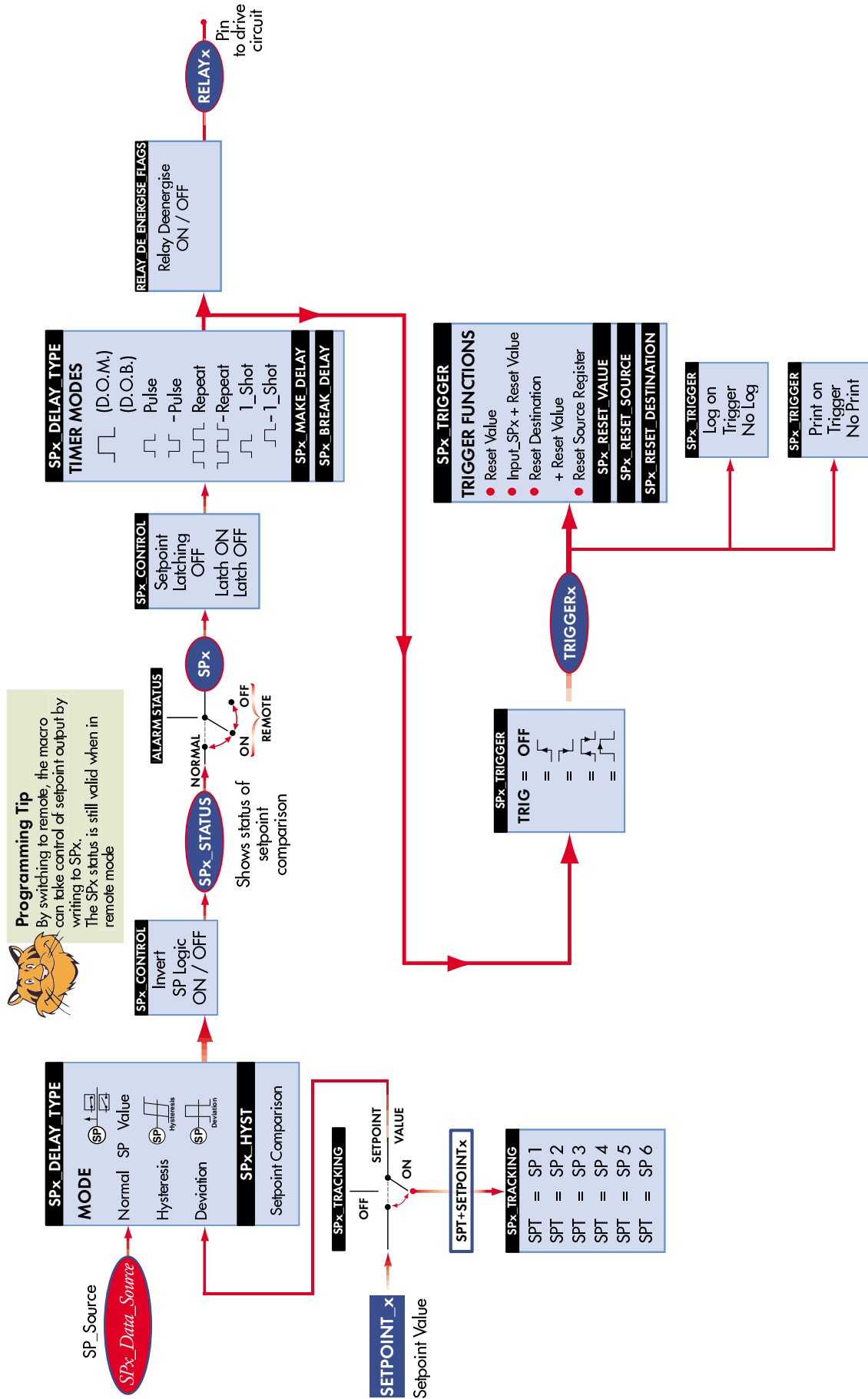

Figure 1 – Setpoint Mode Functional Block Diagram

Setpoint Programming Mode

All Tiger 320 Series meter setpoint and relay functions for Levels 1, 2, and 3 are configured in the meter's setpoint programming mode.

During configuration, the last three digits on the meter display are used to select the setpoint and relay functions. See Figure 2.

Alternately, if the meter is connected to a PC through the serial port, the setpoints can be configured using the Meter Configuration Program.

See *Meter Configuration Utility Program Tutorial (NZ206)* for details.

To enter the setpoint programming mode press the meter's **P** and **↓** buttons at the same time. See Figure 3 – *Setpoint Programming Mode Logic Diagram* for menu details.

Setpoint Activation Values Mode

On entering the setpoint programming mode, the meter display toggles between [SP_1] and [18000]. This is the Setpoint Activation Values Mode. Using the **P** button, step through each setpoint and set the activation value required using the **↑** and **↓** buttons.

Setpoint activation values can be set within the total span range of the meter and the selected input module.

Setpoint and Relay Control Settings Mode

Pressing the **P** button after setting the activation value for SP6 enters the Setpoint and Relay Control Settings Mode. The meter display toggles between [SPC_1] and [XXX]. This is the menu for setting setpoint control functions for SP1. Using the **P** button, step through each setpoint control menu and set the control functions for the required setpoints using the **↑** and **↓** buttons.

The setpoint and relay control settings mode provides access to the following setpoint and relay functions by setting the 1st, 2nd, and 3rd digits on the meter display:

- **First Digit** – Relay Energize Functions.
Allows you to select the required relay energize functions.
- **Second Digit** – Setpoint Activation Source.
Allows you to select the setpoint activation source.
- **Third Digit** – Setpoint Delay, Timer, and Reset and Trigger Functions.
Allows you to select from a range of delays, timers, and reset functions.

Figure 2 shows the front panel of a Tiger 320 Series DI-50 meter.

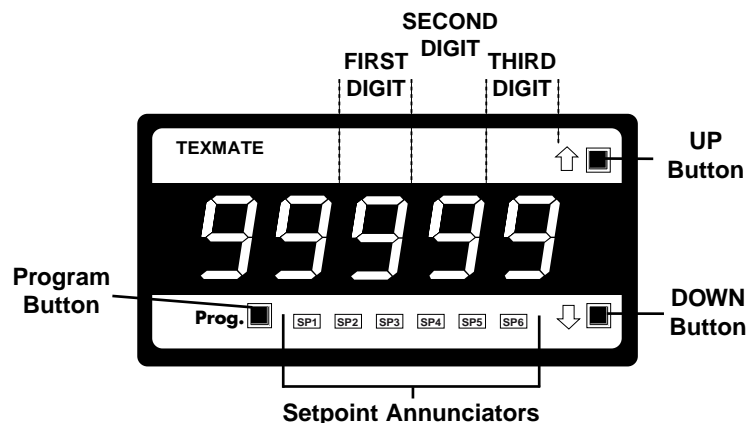

Figure 2 – Meter Programming Digits for Setpoint and Relay Control Functions

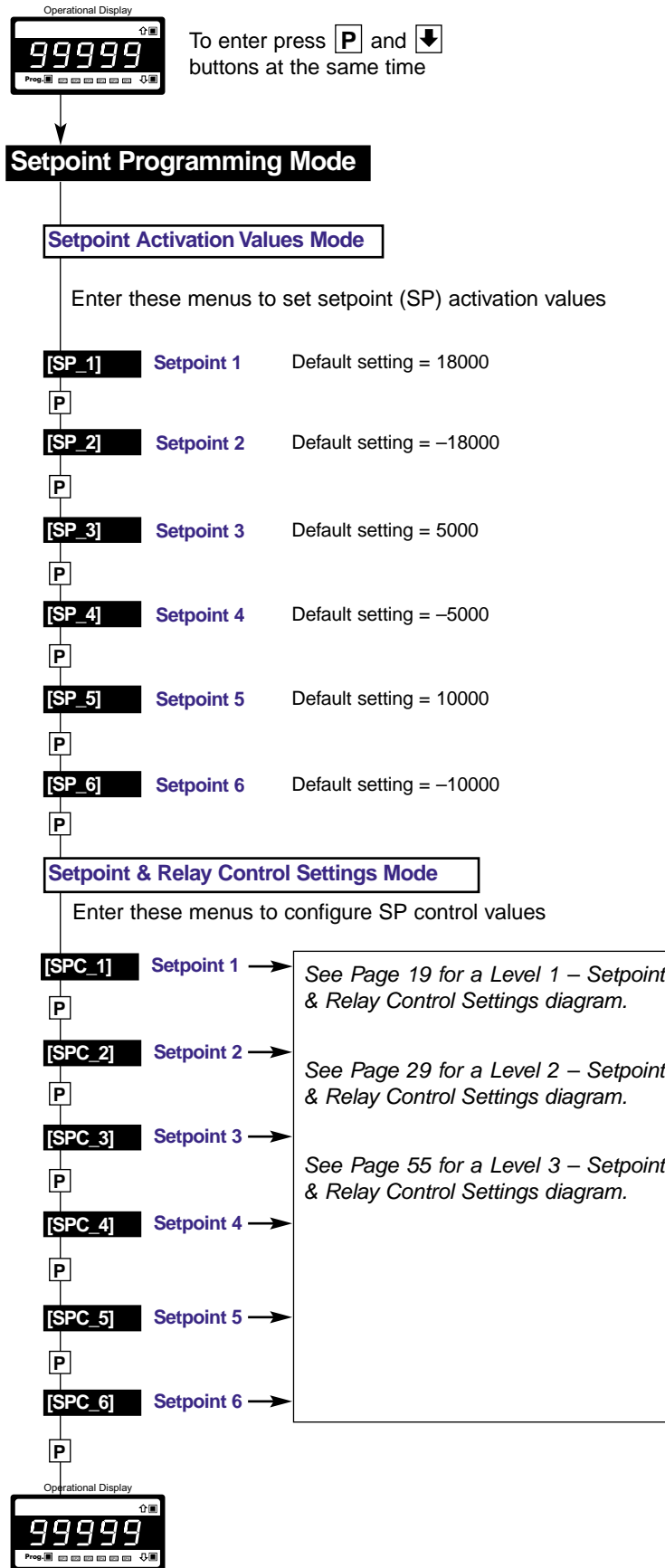

Figure 3 – Setpoint Programming Mode Logic Diagram

Relay Options

Tiger 320 Series DI, FI, and GI meters use the following electromechanical and solid state relays:

- 5 A, 240 VAC Form A, electromechanical relay.
- 10 A, 240 VAC Form C, electromechanical relay.
- 400 V, 210 mA DC, independent normally open solid state relay (SSR).
- 400 V, 140 mA AC / DC, independent normally open SSR.

Electromechanical Relays

There are three standard electromechanical relay output modules available that use a combination of 5 and 10 A electromechanical relays to make a total of twelve relay options:

- Relay Output Module with Six Non-isolated 5 A Form A Relays.
- Relay Output Module with Two Non-isolated 5 A Form A and 2 Non-isolated 10 A Form C Relays.
- Four Isolated 5 A Form A Relays

Six Non-isolated 5 A Form A Relays

This relay output module has a maximum of two groups of three 5 A Form A relays using a common pin. There are a total of two relay combinations available.

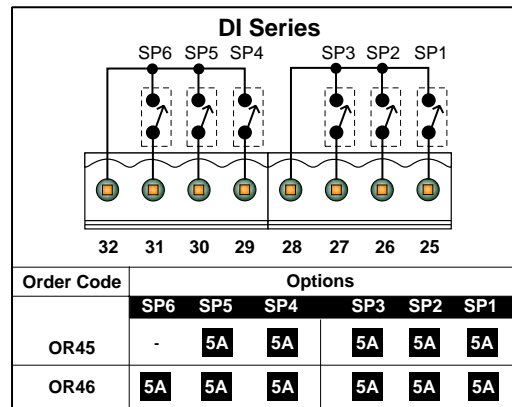

Two Non-isolated 5 A Form A & Two Non-isolated 10 A Form C Relays

This relay output module has a maximum of two groups of two relays. Each group can have a 10 A Form C and 5 A Form A relay using a common pin. There are a total of six relay combinations available.

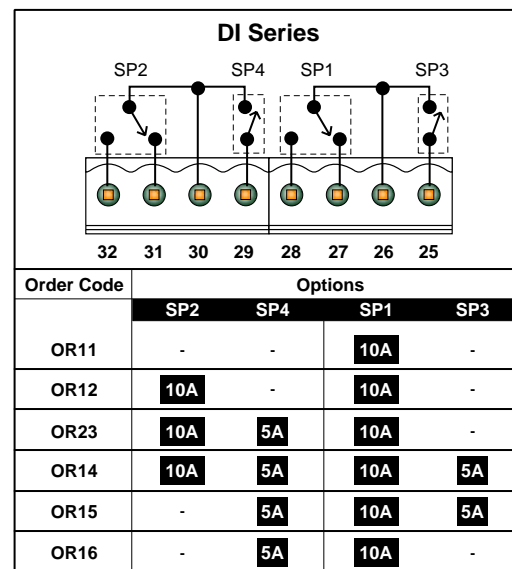

Four Isolated 5 A Form A Relays

This relay output module has a maximum of four isolated 5 A Form A relays. There are a total of four relay combinations available.

DI Series				
	SP4	SP3	SP2	SP1
	32	31	30	29
	28	27	26	25
Order Code	Options			
	SP4	SP3	SP2	SP1
OR31	-	-	-	5A
OR32	-	-	5A	5A
OR33	-	5A	5A	5A
OR34	5A	5A	5A	5A

Solid State Relays

There are two standard solid state relay (SSR) output modules available that provide a total of eight relay options:

- Four Independent 400 V, 210 mA (DC Only) SSR Output Module.
- Four Independent 400 V, 140 mA (AC/DC) SSR Output Module.

Four Independent 400 V, 210 mA (DC Only) SSR Output Module

This SSR output module has a maximum of four independent, normally open output, solid state relays. They are suitable for maximum 400 V, 210 mA DC inputs only.

DI Series				
	SP4	SP3	SP2	SP1
	32	31	30	29
	28	27	26	25
Order Code	Options			
	SP4	SP3	SP2	SP1
OR51	-	-	-	210mA
OR52	-	-	210mA	210mA
OR53	-	210mA	210mA	210mA
OR54	210mA	210mA	210mA	210mA

Four Independent 400 V, 140 mA (AC/DC) SSR Output Module

This SSR output module has a maximum of four independent, normally open output, solid state relays. They are suitable for maximum 400 V, 140 mA AC/DC inputs.

DI Series				
	SP4	SP3	SP2	SP1
	32	31	30	29
	28	27	26	25
Order Code	Options			
	SP4	SP3	SP2	SP1
OR61	-	-	-	140mA
OR62	-	-	140mA	140mA
OR63	-	140mA	140mA	140mA
OR64	140mA	140mA	140mA	140mA

Opto-isolators

An opto-isolated I/O plug-in module is a combination of two boards that provide a total of six digital status inputs and 16 digital status outputs using opto-isolators.

The standard board mounts six inputs and six outputs. The six outputs are controlled by the meter's six programmable setpoints. The six inputs operate via a macro.

An add-on board mounts onto the standard board and provides a further 10 outputs. These also operate via a macro. The opto-isolators have the following specifications:

- Isolation Voltage: 3.7 kV.
- Collector Emitter: 80 V.
- Collector Current: 50 mA.

The opto-isolated I/O module comes complete with a 3M IDC cable connected to a DIN rail terminal block. The setpoint external pinouts to the terminal block are as follows:

Pin	Function	Pin	Function
1	SP1.	7	SP7.
2	SP2.	8	SP8.
3	SP3.	9	SP9.
4	SP4.	10	SP10.
5	SP5.	11	SP11.
6	SP6.	12	SP12.
		13	SP13.
	Meter setpoints SP7 to SP16 require a macro	14	SP14.
		15	SP15.
		16	SP16.

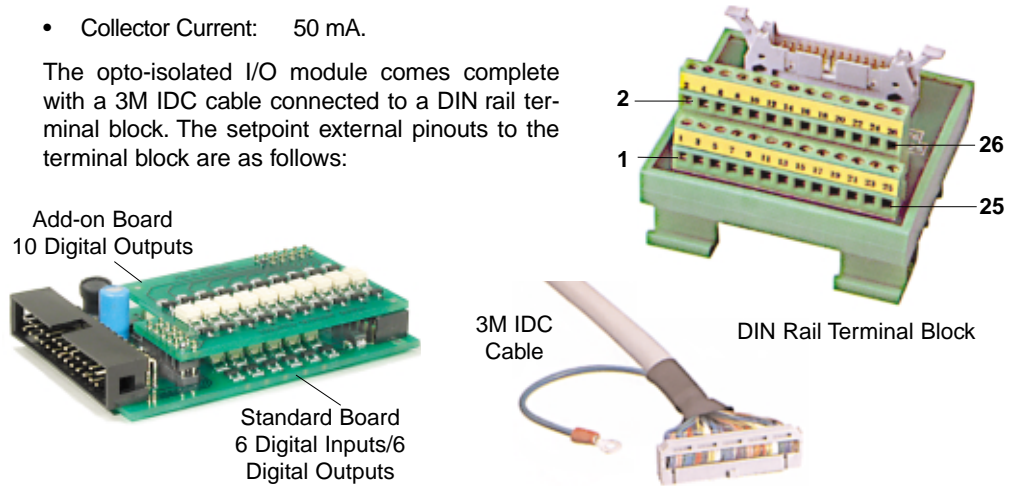

Relay Options

All Tiger 320 Series DI and GI meters use plug-in relay output modules. The GI range can also mount up to four relays in six combinations on its main processor board.

The FI bargraph meter can have up to four electromechanical relays mounted on its main board and two solid state relays (SSRs) on its output carrier board.

See Figure 4.

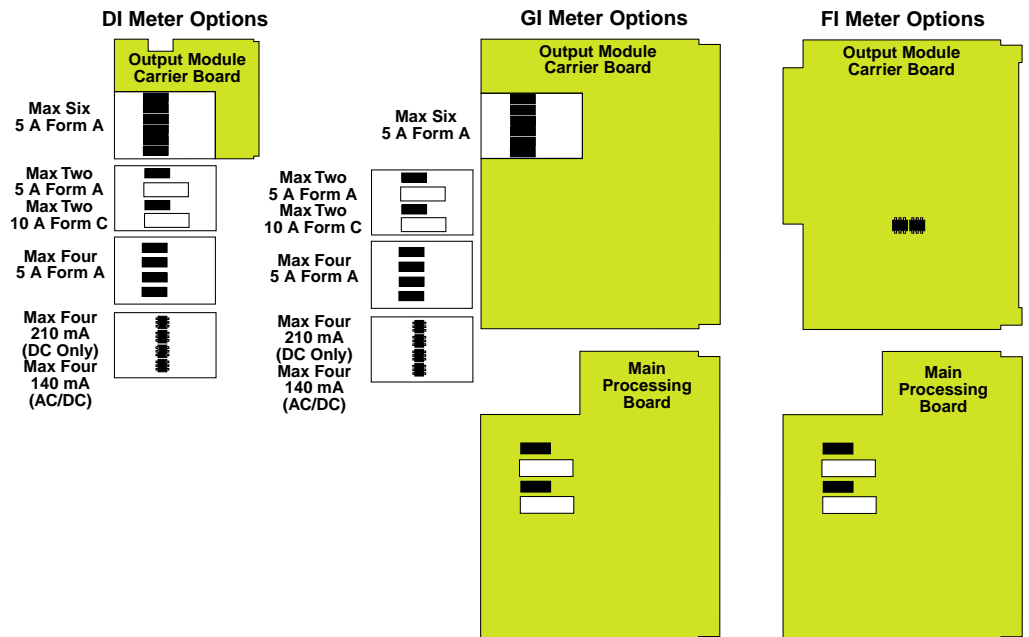

Figure 4 – Tiger 320 Series Relay Options

GI-50 & GI-50B101 Meter Relays

The GI-50 and GI-50B101 support the standard electromechanical and solid state relay output modules on their **output carrier board**. They can also support up to four electromechanical relays on the **main processing board**.

The relay combination selected for the **main processing board** use setpoints 1 to 4. If a plug-in relay output module with more than two relays is also selected for the **output carrier board**, then both sets of relays designated SP1 to SP4 share setpoints 1 to 4.

GI-50 or GI-50B101 Main / Processor Board

Maximum 2 groups of 1x10 A Form C & 1x5 A Form A Relays using one common pin per group

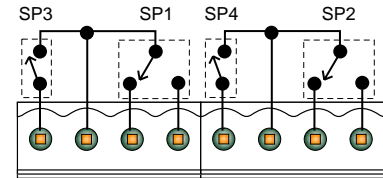

PIN Numbers: 9 10 11 12 13 14 15 16

Order Code	Options			
	SP3	SP1	SP4	SP2
R11	-	10A	-	-
R12	-	10A	-	10A
R23	5A	10A	-	10A
R14	5A	10A	5A	10A
R15	5A	10A	5A	-
R16	5A	10A	-	-

FI-B101D50 Bargraph Relays

The FI-B101D50 bargraph combines up to two 5 A Form A and two 10 A Form C electromechanical relays on its main / processor board. An optional output carrier board combines two solid state relays.

The solid state relays are normally open outputs and are suitable for maximum 400 V, 210 mA DC inputs only.

Carrier Board (DC ONLY)

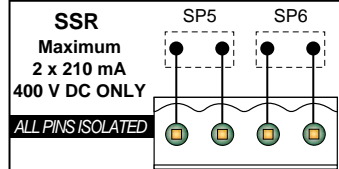

PIN Numbers: 31 30 29 28

Order Code	Options	
	SP5	SP6
R1	210mA	-
R2	210mA	210mA

FI-B101D50 Main / Processor Board

Maximum 2 groups of 1x10 A Form C & 1x5 A Form A Relays using one common pin per group

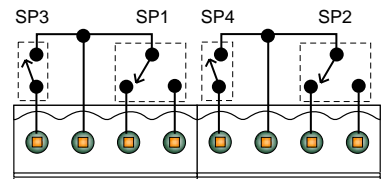

PIN Numbers 9 10 11 12 13 14 15 16

Order Code	Options			
	SP3	SP1	SP4	SP2
R11	-	10A	-	-
R12	-	10A	-	10A
R23	5A	10A	-	10A
R14	5A	10A	5A	10A
R15	5A	10A	5A	-
R16	5A	10A	-	-



Level 1 – Basic Mode



Level 1 – Relay and Setpoint Configuration Sequence

When configuring each setpoint for Level 1 settings, the following programming sequence must be followed to ensure that all configuration settings are correctly entered and saved:

START HERE



1

Enter the Setpoint Programming Mode

Press the  and  buttons at the same time. This enters the setpoint programming mode. The display toggles between [SP_1] and [18000].

2

Adjust Setpoint Activation Values

Use the  and  buttons to adjust the setpoint 1 (SP1) activation value. If not SP1, press the  button to move to the required setpoint and adjust.

Adjust all other applicable setpoint activation values as required (SP2 to SP6).

3

Select Setpoint Control Function Settings



After all required setpoint activation values have been adjusted, press the  button until [SPC_1] appears. SPC_1 is the setpoint control function programming menu for setpoint 1.

Set the three digits in the following order:



LEVEL 1 – BASIC FUNCTIONS

➤ 1) 3rd Digit – Turn OFF Intermediate and Advanced Level Modes



Set display to [XX5]

Press the  button to enter the **Hysteresis, Deviation, & PID Mode** sub-menu. Display toggles between [ModE] and [oFF]. If not set to [oFF], use the  or  button to select [oFF].

Set display to [XX6]

Press the  button to enter the **Timer Mode** sub-menu. Display toggles between [tiMr] and [oFF]. If not set to [oFF], use the  or  button to select [oFF].

Set display to [XX7]

Press the  button to enter the **Advanced Functions Mode** sub-menu. Display toggles between [triG] and [oFF]. If not set to [oFF], use the  or  button to select [oFF].

When complete, reset the third digit to [XX0] to prevent cycling through the mode.

➤ 2) 2nd Digit – Select Setpoint Activation Source

Set to [X1X]

Press the  button to enter the sub-menu and select the setpoint activation source for SP1 from any channel or selected register. When complete, reset back to [000].

If the SP source is from an **external switched input** (digital input pin), set to one of either [X2X] to [X7X] to select the setpoint activation source from one of six digital inputs (2 to 7).

➤ 3) 1st Digit – Select Relay Energize Mode

Select the relay energize mode for SP1 from either [0XX] or [1XX].

➤ 4) 3rd Digit – Relay Latching & Manual Reset Functions

Select the 3rd digit setpoint relay latching and manual reset functions either [XX0] to [XX4] as required.



Programming Tip

As a final setting, combine Steps 3 and 4 to select the relay energize mode and the latching and manual reset functions into a single step.

4

Record All Setpoint Programming Code Settings

Record all SP1 activation and control values in the Table: *Customer Code Settings – Setpoint Programming Mode* on Page 15 of the *Tiger 320 Series Programming Code Sheet (NZ101)*.

5

Repeat Setpoint Control Function Settings for all Applicable Setpoints

Press the **[P]** button to move to [SPC_2]. SPC_2 is the setpoint control function programming menu for setpoint 2 (SP2).

Repeat Steps 3 and 4 for all applicable setpoints.

6

Exit the Setpoint Programming Mode

Press the **[P]** button to save a setpoint programming mode setting and then press the **[P]** and **[F]** buttons at the same time to return to the operational display.

END HERE

Level 1 – Setpoint & Relay Control Settings Diagram

The following diagram shows the setpoint and relay three digit control function settings for operational Level 1.

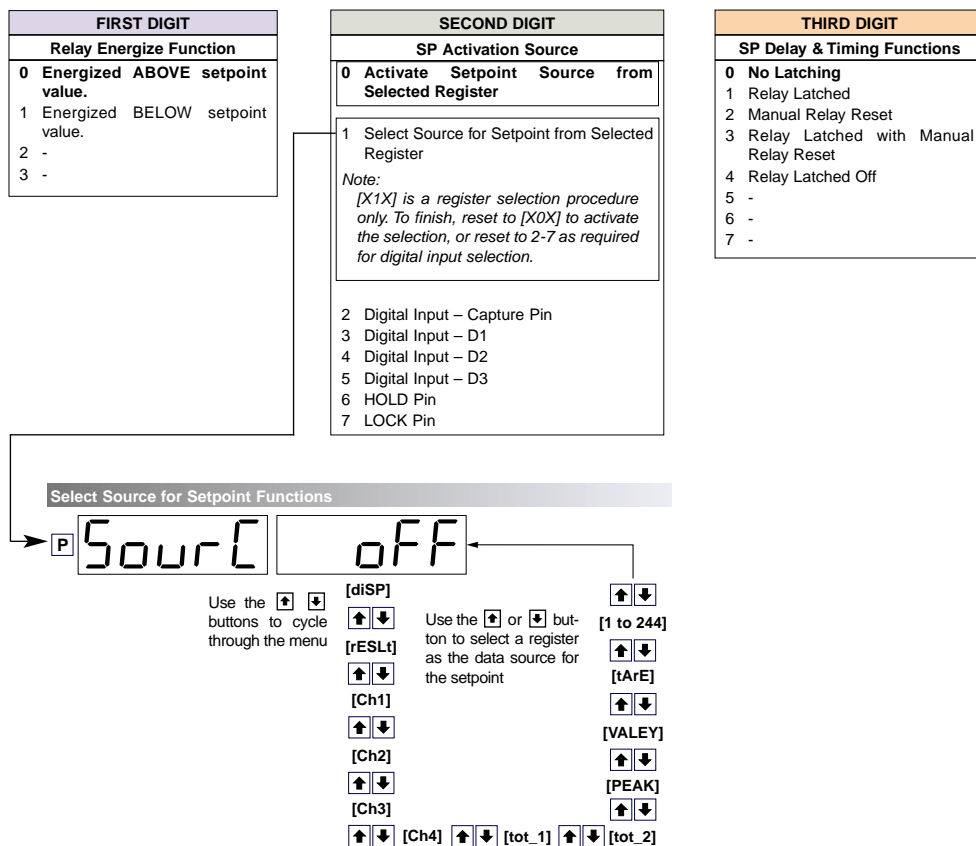

Level 1 – 1st Digit: Relay Energize Functions

The **1st digit** of the setpoint and relay control mode allows you to configure **relay energize functions**.

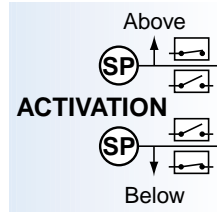

FIRST DIGIT	
Relay Energize Function	
0	Energized ABOVE setpoint value.
1	Energized BELOW setpoint value.
2	-
3	-

All setpoints activate at the **setpoint activation value**. At **Level 1**, the 1st digit allows you to program the setpoint relay to energize **above** or **below** the setpoint value.

Level 1 – 2nd Digit: Setpoint Activation Source

The **2nd Digit** of the setpoint and relay control mode allows you to configure the **setpoint activation source**.

The settings and functionality of the 2nd digit remain the same for Levels 1, 2, and 3. The activation source must be programmed for all required setpoints.

The 2nd digit allows you to individually program the activation source for setpoints 1 to 6 from one of eight selections. Setpoints activate from any input channel, selected meter register, or an external switched input (via digital input pin).

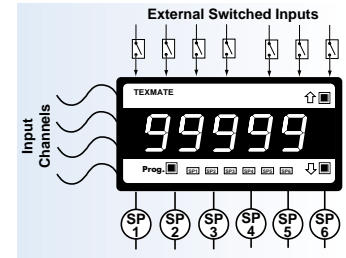

Note:

The setpoint activation source of any unused setpoints can be set to off. This improves efficiency and stops unused setpoint activation values being displayed.

SECOND DIGIT	
SP Activation Source	
0	Activate Setpoint Source from Selected Register (select in 3rd digit)
1	Select Source for Setpoint from Selected Register
<p>Note: [X1X] is a register selection procedure only. To finish, reset to [X0X] to activate the selection, or reset to 2-7 as required for digital input selection.</p>	
2	Digital Input – Capture Pin
3	Digital Input – D1
4	Digital Input – D2
5	Digital Input – D3
6	HOLD Pin
7	LOCK Pin

To 3rd digit

Select Source for Setpoint Functions

Source off

Use the [↑] [↓] buttons to cycle through the menu

Use the [2] or [3] button to select a register as the data source for the setpoint

[diSP] [1 to 244]

[rESL] [tArE]

[Ch1] [VALE]Y

[Ch2] [PEAK]

[Ch3] [tot_1] [tot_2]

[Ch4] [tot_1] [tot_2]

[X0X] Activate Setpoint Source from Selected Register

Setting the 2nd digit to 0 [X0X] means that the source selected for the setpoint when the 2nd digit is set to [X1X] is now active for that setpoint. When selection of the setpoint activation source in [X1X] is complete, reset back to [X0X].

Also, setting the 2nd and 3rd digits to [X05] to [X07] is the easiest method of entering Level 2 or Level 3 function setup modes.

[X1X] Select Source for Setpoint

Selecting [X1X] allows you to select the activation source for setpoints 1 to 6 from any operational channel or meter register (#1 to 244).

This is a register selection menu only. To leave this menu and activate the selection, reset the display [SPC_X] to [X0X].

[X2X] Digital Input – Capture Pin

Selecting [X2X] allows you to program setpoint activation from a switched input via the meter's **capture pin**.

[X3X] Digital Input – D1

Selecting [X3X] allows you to program setpoint activation from a switched input via the **D1 pin** on selected smart input modules.

See *Advanced Input Module Supplement* for further information on smart input modules.

[X4X] Digital Input – D2

Selecting [X4X] allows you to program setpoint activation from a switched input via the **D2 pin** on selected input modules.

See *Advanced Input Module Supplement* for further information on smart input modules.

[X5X] Digital Input – D3

Selecting [X5X] allows you to program setpoint activation from a switched input via the **D3 pin** on selected input modules.

See *Advanced Input Module Supplement* for further information on smart input modules.

[X6X] Digital Input – Hold Pin

Selecting [X6X] allows you to program setpoint activation from a switched input via the meter's **hold pin**.

[X7X] Digital Input – Lock Pin

Selecting [X7X] allows you to program setpoint activation from a switched input via the meter's **lock pin**.



Note:

When a digital input pin is selected as a setpoint source, the setpoint activation value for that setpoint becomes irrelevant and is not displayed.

Level 1 – 3rd Digit: Latching and Reset

The **3rd digit** allows you to configure the latching functionality of the setpoints and relays.

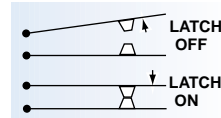

Selecting [XX0] to [XX4] allows you to program the setpoint for one of five relay latching and manual reset modes.

THIRD DIGIT	
SP Delay & Timing Functions	
0	No Latching
1	Setpoints Latched
2	Manual Relay Reset
3	Setpoints Latched with Manual Relay Reset
4	Setpoints Latched Off
5	-
6	-
7	-

[XX0] No Latching

Selecting [XX0] means that no latching is applied to the setpoints. See Figure 5 for an example.

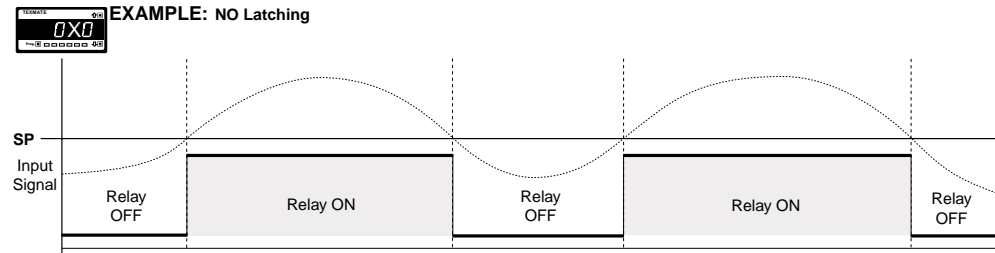

Figure 5 – NO Latching

[XX1] Setpoint Latching

Selecting [XX1] means that latching is applied to the setpoints. See Figure 6 for an example.

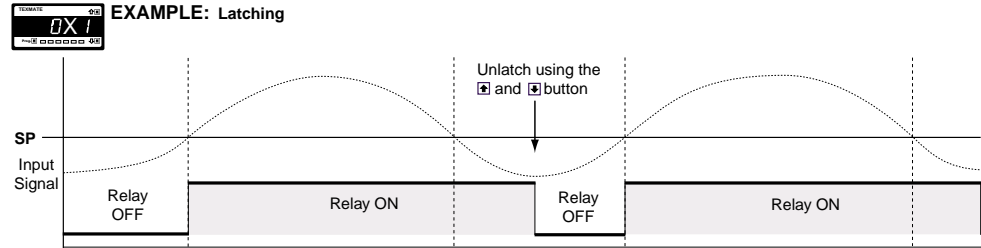

Figure 6 – Setpoint Latching

[XX2] Manual Relay Reset

Selecting [XX2] means that the relay can be de-energized (reset) manually by the operator. The relay does not energize again until the setpoint reactivates.

Pressing the [Up] and [Down] buttons on the meter's front panel at the same time manually resets the relay setpoint by the operator. Or it can be reset from a remote switch (Code 9 set to [X7X] or [XX7]). See Figure 7 for an example.

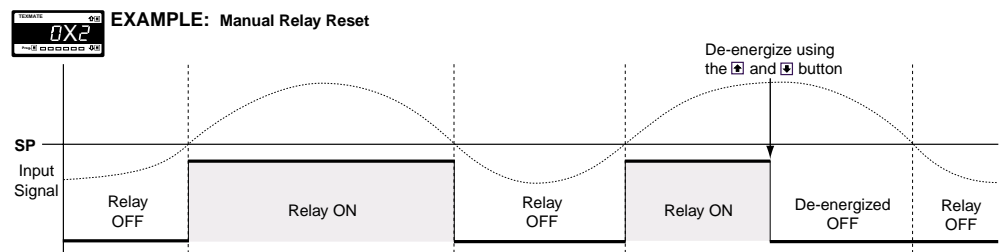

Figure 7 – Manual Relay Reset



Note:

A setpoint can be reset from a remote switch in any of the latching modes (Code 9 set to [X7X] or [XX7]).

[XX3] Setpoint Latched with Manual Relay Reset

Selecting [XX3] means that setpoint latching is applied and the relay can be de-energized (reset) manually by the operator. The relay does not energize again until the next setpoint activation. See Figure 8 for an example.

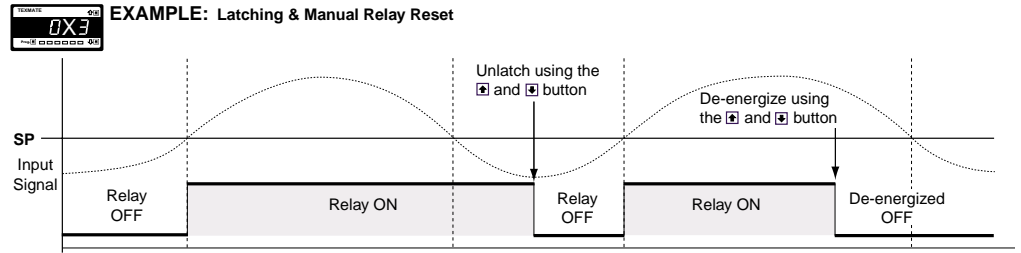

Figure 8 – Latching & Manual Relay Reset

[XX4] Setpoint Latched OFF

Selecting [XX4] means that latching is applied to the setpoint but in the latched OFF mode. See Figure 9 for an example.

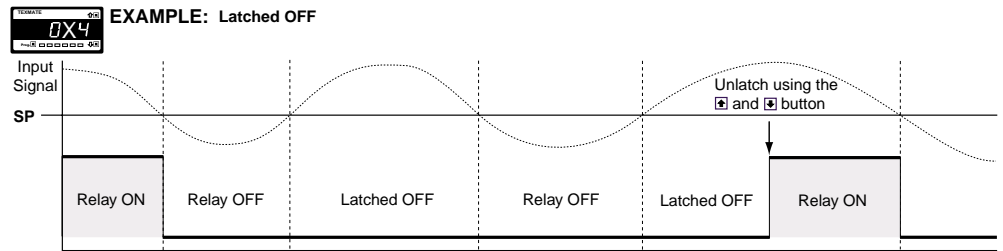

Figure 9 – Latched OFF

Level 1 – Example Configuration Procedures

Configure the setpoint activation values and the required setpoint control settings for Level 1.

Example – Setpoint Activation Values

See *Level 1 – Setpoint Activation Values: Example Procedure*.

This example describes how to adjust the setpoint activation value for setpoint 1 to 10,000 counts. All other setpoint activation values are adjusted in the same way.

Example – Setpoint Control Settings

See *Level 1 – Relay Energize, Latching, & SP Activation Source Settings: Example Procedure*.

This example describes how to configure setpoint 1 for the following Level 1 (basic) setpoint control operations:

- **1st Digit – Relay Energize.** Configure the relay to energize **above** the setpoint value.
- **2nd Digit – SP Activation Source.** Select **channel 1** as the activation data source for setpoint 1.
- **3rd Digit – Setpoint Latching.** Configure the setpoint to **latch with manual relay reset**.

LEVEL 1 – Setpoint Activation Values: Example Procedure

Adjust the setpoint activation value for setpoint 1.

START HERE Configure Setpoint Activation Value Settings

Example Procedure

Adjust setpoint 1 to activate at 10,000 counts.

Using Steps 2 and 3 adjust all other applicable setpoint activation values.



Programming Tip

Record the values in the Table: Customer Code Settings – Setpoint Programming Mode on Page 15 of the Tiger 320 Series Programming Code Sheet.



Programming Tip

To save and exit the setpoint programming mode at any time, press the **P** button to save the setpoint settings you are currently programming.

Then, press the **P** and **↓** buttons at the same time to return to the operational display.



Programming Tip

Configuring the setpoint activation values and levels 1, 2, and 3 setpoint control functions can either be carried out individually, or as one complete procedure.

Configuring as one complete procedure means there is no need to leave the setpoint programming mode until the procedure is complete.

For a description of the sequence to configure a setpoint through all setpoint and relay functions in one complete procedure, see Relay and Setpoint Configuration Sequence at the beginning of Level 1, Level 2, and Level 3.

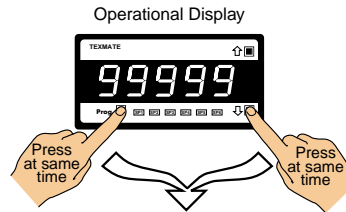

Step 1
Enter the Setpoint Programming Mode

Setpoint Activation Values Mode

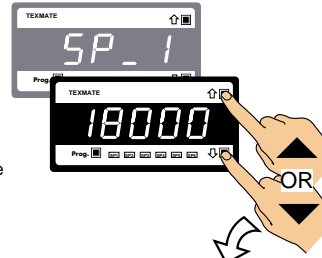

Step 2
Adjust the setpoint to the required activation value



Step 3
Save the settings and proceed to adjust all required setpoint activation value settings

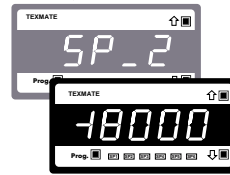

Step 4
Repeat Steps 2 and 3 for all applicable setpoints (SP2 thru SP6)

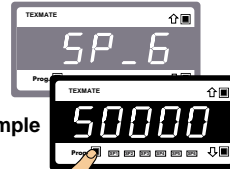

Step 5
After all setpoints have been adjusted, save the setpoint values in the meter by pressing the PROGRAM button repeatedly until [SPC_6] appears

OR Continue Programming

Setpoint and Relay Control Functions Mode



Step 6
Exit SPC_6 and return to the operational display

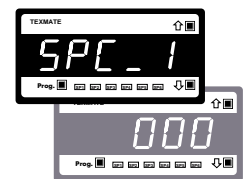

Enter the Setpoint and Relay Control Functions Mode and program the control settings for each setpoint relay in turn (SPC_1 thru SPC_6)

See Level 1 – Setpoint Control Setting Example Procedure for an example procedure to configure SP1 Level 1 functions



Operational Display

LEVEL 1 – Relay Energize, Latching, & SP Activation Source: Example Procedure

START HERE

Configure Level 1 Settings

Step 1
Enter Setpoint Programming Mode

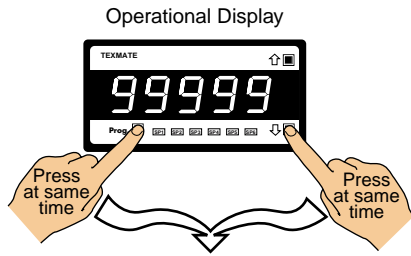

Step 2
Pass thru SP1 to SP6 and enter SPC_1

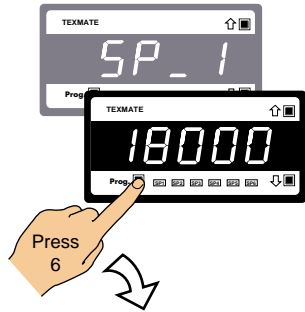

Step 3
Set SPC_1 to [013]:
1st Digit = 0 Energize above SP1 value
2nd Digit = 1 Select data source for SP1
3rd Digit = 3 Relay latching with manual reset

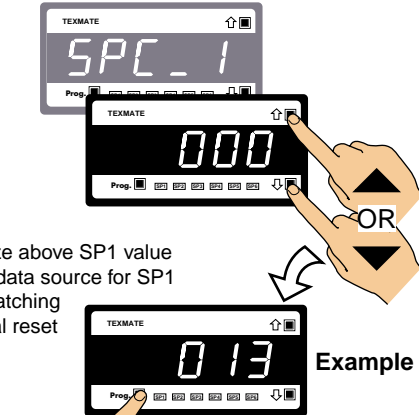

Step 4
Enter SP1 source sub-menu

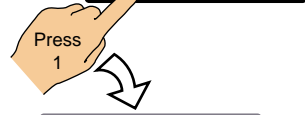

Step 5
Select [Ch1] as the SP1 activation source. See Select Data Source diagram below

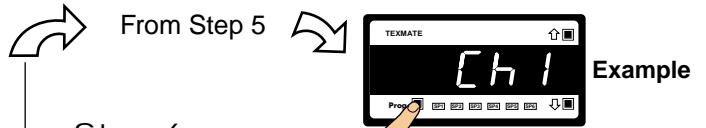
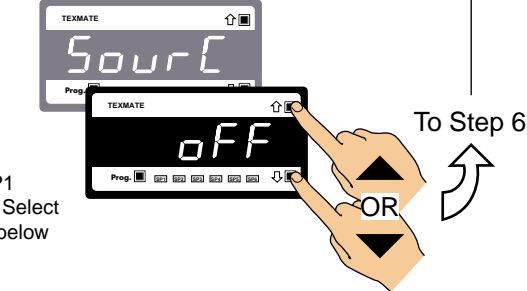

Step 6
Save SP1 control settings

Step 7
Reset 2nd digit to 0 (This activates the setpoint source from the selected register). If the 2nd digit is not reset to 0, the meter will constantly cycle thru SPC_1

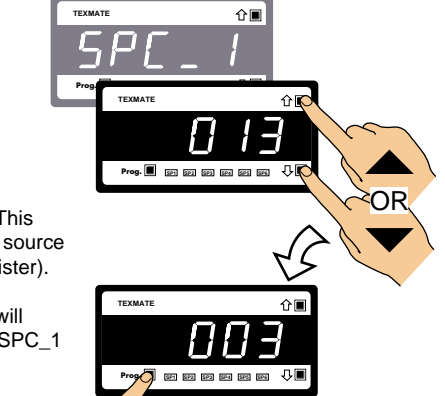

Step 8
Save SP1 control settings

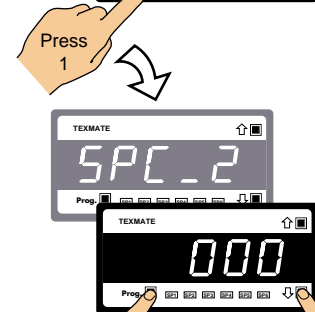

Step 9
Exit SPC_2 and return to operational display

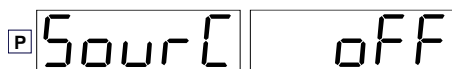
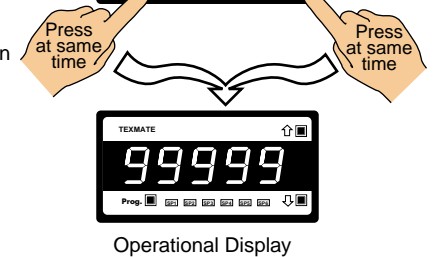

Use the \uparrow \downarrow buttons to cycle through the options

[diSP]

\uparrow \downarrow

[rESL1] \uparrow \downarrow [Ch1] \uparrow \downarrow [Ch2] \uparrow \downarrow [Ch3] \uparrow \downarrow [Ch4] \uparrow \downarrow [tot_1] \uparrow \downarrow [tot_2] \uparrow \downarrow [PEAK] \uparrow \downarrow [VALEY] \uparrow \downarrow [tArE]

Use the \uparrow \downarrow buttons to select register number as data source for setpoint. [1 to 244]

This Page intentionally left blank









Level 2 – Intermediate Mode

Level 2 – Relay and Setpoint Configuration Sequence

When configuring each setpoint for Level 2 settings, the following programming sequence must be followed to ensure that all configuration settings are correctly entered and saved:

START HERE

- 1 Enter the Setpoint Programming Mode**
Press the  and  buttons at the same time. This enters the setpoint programming mode. The display toggles between [SP_1] and [18000].
- 2 Adjust Setpoint Activation Values**
Use the  and  buttons to adjust the setpoint 1 (SP1) activation value. If not SP1, press the  button to move to the required setpoint and then adjust.
Adjust all other applicable setpoint activation values as required (SP2 to SP6).
- 3 Select Setpoint Control Function Settings**
After all required setpoint activation values have been adjusted, press the  button until [SPC_1] appears. SPC_1 is the setpoint control function programming menu for setpoint 1.
Set the three digits in the following order:

LEVEL 2 – INTERMEDIATE FUNCTIONS

- **1) Third Digit – Configure Hysteresis, Deviation & PID Settings [XX5]**
If **hysteresis, deviation, or PID** is required, set to [XX5]. Press the  button to enter the **Hysteresis, Deviation & PID Mode** sub-menu and program the hysteresis, deviation, or PID settings as required.

When complete, reset back to [XX0].
- **2) Third Digit – Configure Timers [XX6]**
If a **timer** is required, set to [XX6]. Press the  button to enter the **Timer Modes** sub-menu, select and program one of seven time control modes as required for SP1.

When complete, reset back to [XX0].
- **3) Second Digit – Select Setpoint Activation Source**
Set to [X1X]
Press the  button to enter the sub-menu and select the setpoint activation source for SP1 from any channel or selected register. When complete, reset back to [000].

If the SP source is from an **external switched input** (digital input pin), set to one of either [X2X] to [X7X] to select the setpoint activation source from one of six digital inputs (2 to 7).
- **4) First Digit – Select Relay Energize Mode**
Select the **relay energize mode and initial start-up setting** for SP1 from either [0XX] to [3XX].
- **5) Third Digit – Relay Latching & Manual Reset Functions**
Select the **relay latching and manual reset functions** from either [XX0] to [XX4] as required.



Programming Tip

As a final setting, combine Steps 4 and 5 to select the relay energize mode and the latching and manual reset functions into a single step.

4

Record All Setpoint Programming Code Settings

Enter all SP1 activation and control values in the Table: *Customer Code Settings – Setpoint Programming Mode* on Page 15 of the *Tiger 320 Series Programming Code Sheet (NZ101)*.

5

Repeat Setpoint Control Function Settings for all Applicable Setpoints

Press the **[P]** button to move to [SPC_2]. SPC_2 is the setpoint control function programming menu for setpoint 2 (SP2).

Repeat Steps 3 and 4 for all applicable setpoints.

6

Exit the Setpoint Programming Mode

Press the **[P]** button to save a setpoint programming mode setting and then press the **[P]** and **[↓]** buttons at the same time to return to the operational display.

END HERE

Level 2 – Setpoint & Relay Control Settings Diagram

The following diagram shows the setpoint and relay three digit control function settings for operational Level 2.

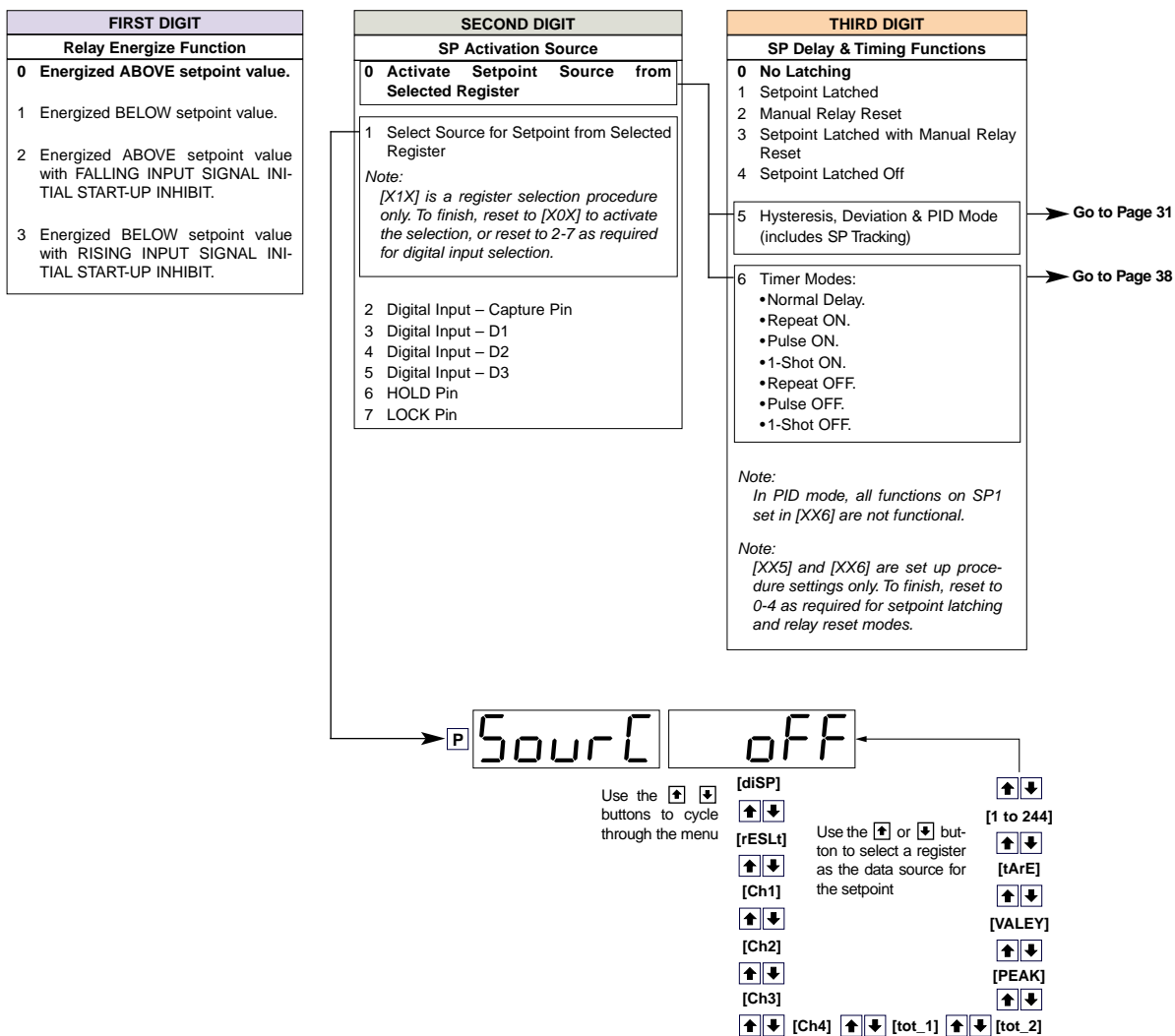

Level 2 – 1st Digit: Relay Energize Functions

At **Level 2**, the 1st digit also allows you to program the setpoint relay to energize **above** or **below** the setpoint value, but this is further controlled by the mode selected when the third digit is set to [XX5]. This can be either:

- Hysteresis.
See Page 32 for further details.
- Deviation.
See Page 34 for further details.
- PID.
See Page 35 for further details.

The hysteresis and deviation modes can also be programmed to energize the relay with or without **initial start-up inhibit**.

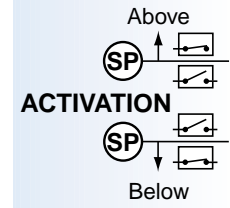

FIRST DIGIT
Relay Energize Function
0 Energized ABOVE setpoint value.
1 Energized BELOW setpoint value.
2 Energized ABOVE setpoint value with FALLING INPUT SIGNAL INITIAL START-UP INHIBIT.
3 Energized BELOW setpoint value with RISING INPUT SIGNAL INITIAL START-UP INHIBIT.

Initial Start-up Inhibit

On switch-on when set to either [0XX] or [1XX], initial start-up inhibit prevents the relay from energizing on the first setpoint activation cycle. When set to [2XX] initial start-up inhibit only functions during a falling input signal. When set to [3XX] initial start-up inhibit only functions during a rising input signal. The signal must activate then deactivate the setpoint, and only when the setpoint activates for the second time does the relay energize.

Figure 10 – Example 1 shows the relay energize functions without hysteresis or deviation applied, but with and without initial start-up inhibit.

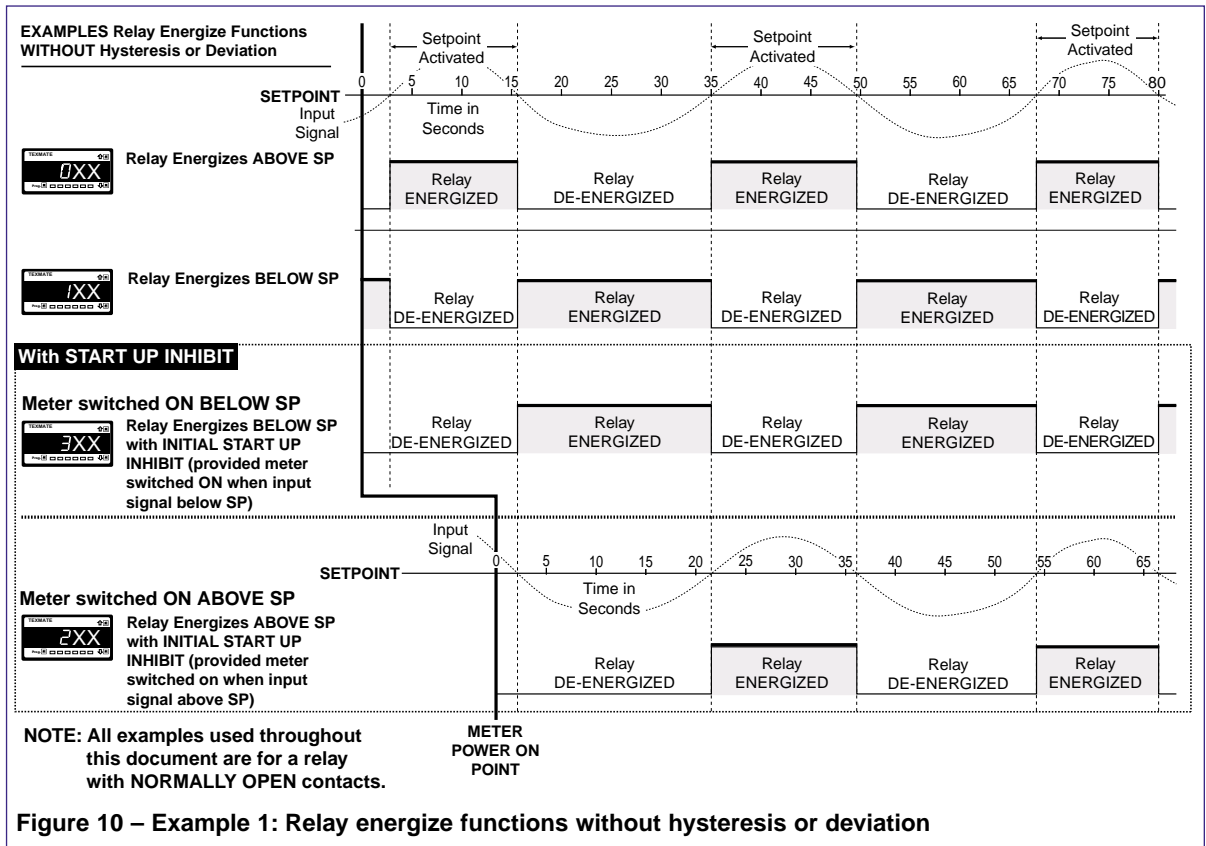

Level 2 – 2nd Digit: Setpoint Activation Source

The settings and functionality of the 2nd digit remain the same for Levels 1, 2, and 3. The activation source must be programmed for all required setpoints.

See *Level 1 – 2nd Digit: Setpoint Activation Source* for further details.

Level 2 – 3rd Digit: Latching and Reset

The settings and functionality of the **3rd digit latching and reset functions** remain the same for Levels 1, 2, and 3.

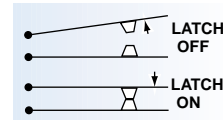

Selecting [XX0] to [XX4] allows you to program the setpoint for one of five relay latching and manual reset modes.

THIRD DIGIT	
SP Delay & Timing Functions	
0	No Latching
1	Setpoints Latched
2	Manual Relay Reset
3	Setpoints Latched with Manual Relay Reset
4	Setpoints Latched Off
5	-
6	-
7	-

See *Level 1 – 3rd Digit: Latching and Reset* for further details.

Level 2 – 3rd Digit: Hysteresis, Deviation, and PID

Selecting [XX5] and pressing the **[P]** button enters the Level 2 setpoint control mode and makes the following modes available for further programming:

- Hysteresis.
- Deviation.
- PID on setpoints 1 and 2.

Individual settings can be programmed for all required setpoints. Setpoints not required in this mode can be set to OFF.

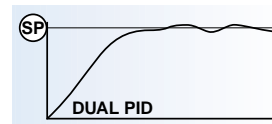
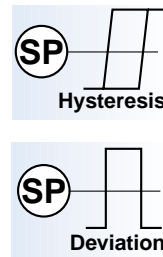

THIRD DIGIT	
SP Delay & Timing Functions	
0	No Latching
1	Setpoint Latched
2	Manual Relay Reset
3	Setpoint Latched with Manual Relay Reset
4	Setpoint Latched Off
5	Hysteresis, Deviation & PID Mode (includes SP Tracking)

Note:
In PID mode, all functions on SP1 set in [XX6] are not functional.

Note:
[XX5] is a set up procedure setting only. To finish, reset to 0-4 as required for setpoint latching and relay reset modes.



Programming Tip

If you do not require any of the functions in this mode, ensure it is set to:

[ModE] [oFF]

Third digit set to [XX5]

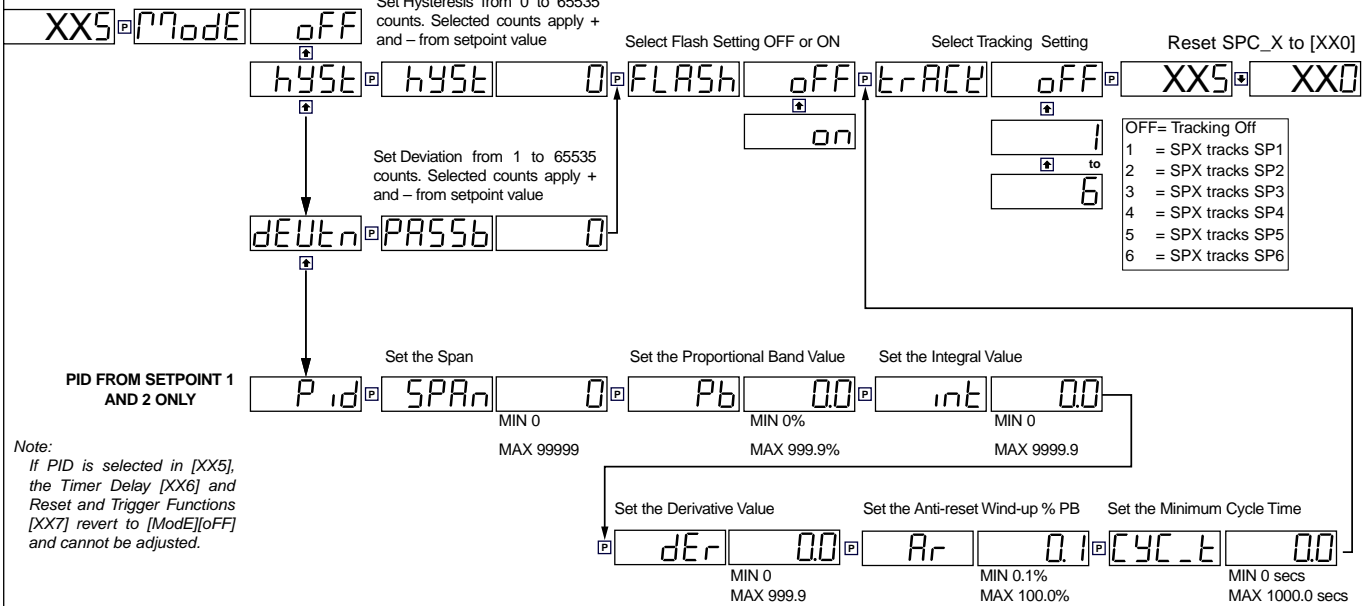

Note:
If PID is selected in [XX5], the Timer Delay [XX6] and Reset and Trigger Functions [XX7] revert to [ModE][oFF] and cannot be adjusted.

Note:
If minimum cycle time is set to 0, the relevant relay is disabled; PID functions still operate.

Hysteresis

Each setpoint can be individually programmed to energize the relay in the hysteresis mode, with or without initial start-up inhibit.



See Figures 11 and 12. Hysteresis (deadband) is the programmable band above and below the setpoint value that determines when and for how long the relay is energized or de-energized. The setpoint can be programmed to energize the relay above or below the setpoint value.

The hysteresis setting can be any value between 0 and 65535 counts. The number of counts selected act both positively and negatively on the setpoint, forming a hysteresis band around the setpoint.

For example, if the setpoint setting is 500 counts and the hysteresis setting is 10 counts, the hysteresis band around the setpoint setting is 20 counts, starting at 490 counts and ending at 510 counts.

[0X5] Relay Energizes Above SP Value

With 0 selected in the 1st digit, the relay energizes **at or above** the setpoint value **plus** the hysteresis counts, then de-energizes **below** the setpoint value **minus** the hysteresis counts.



Note:
If hysteresis is set with ZERO counts, the relay energizes AT or ABOVE the setpoint value.

Hysteresis

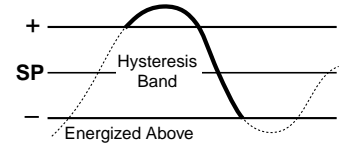
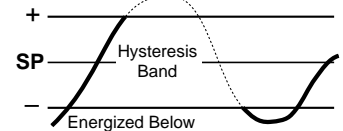

Hysteresis with Initial Start Up Inhibit

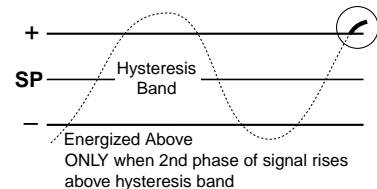
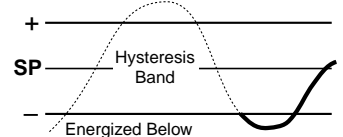

Figure 11 – Hysteresis Delay

[1X5] Relay Energizes Below SP Value

With 1 selected in the 1st digit, the relay energizes **below** the setpoint value **minus** the hysteresis counts, then de-energizes **at or above** the setpoint value **plus** the hysteresis counts.



Note:

If hysteresis is set with ZERO counts, the relay energizes BELOW the setpoint value.

[2X5] Relay Energizes Above SP Value With Initial Start-up Inhibit

With 2 selected in the 1st digit, the relay energizes **at or above** the setpoint value **plus** the hysteresis counts, then de-energizes **below** the setpoint value **minus** the hysteresis counts. With **falling input signal initial start-up inhibit**, the signal activates then de-activates the setpoint, and only when the setpoint activates for the second time on a rising signal does the relay energize.



Note:

If hysteresis is set with ZERO counts, the relay energizes AT or ABOVE the setpoint value.

[3X5] Relay Energizes Below SP Value With Initial Start-up Inhibit

With 3 selected in the 1st digit, the relay energizes **below** the setpoint value **minus** the hysteresis counts, then de-energizes **at or above** the setpoint value **plus** the hysteresis counts. With **rising input signal initial start-up inhibit**, the signal activates then de-activates the setpoint, and only when the setpoint activates for the second time on a falling signal does the relay energize.

Examples of Relay Energize with Hysteresis

Figure 12 – Example 1 shows the relay energize functions with hysteresis applied with and without initial start-up inhibit.

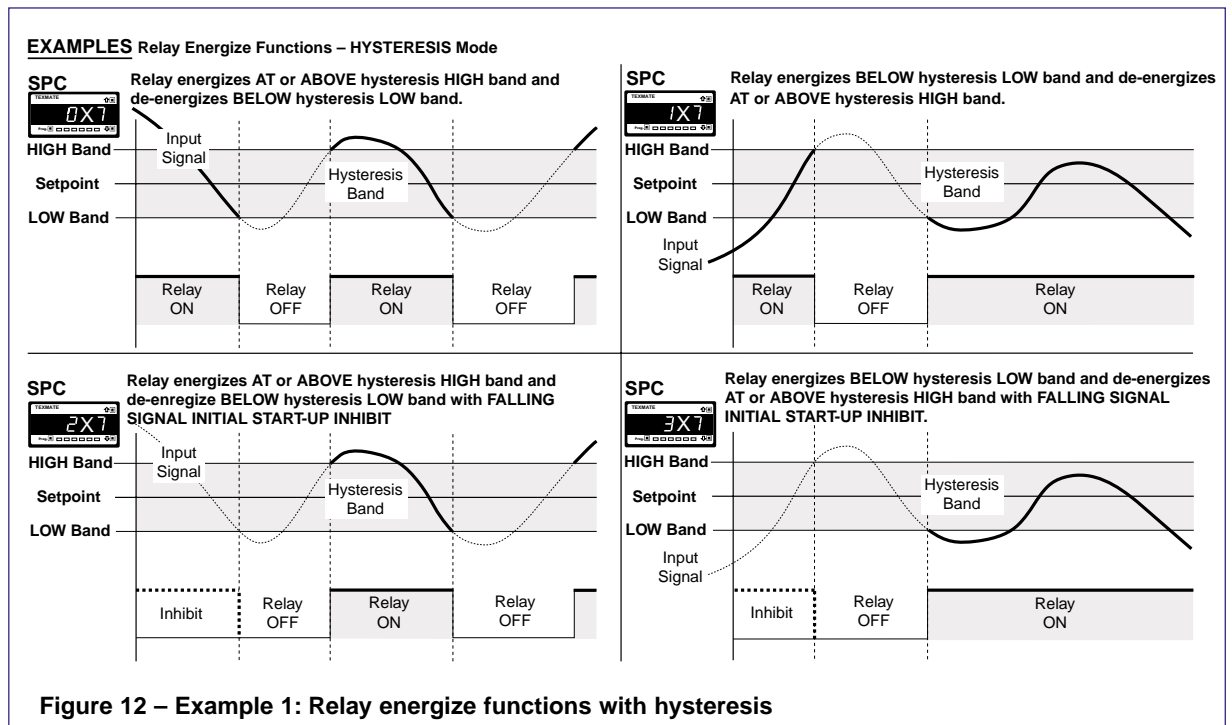

Deviation

See Figures 13 and 14. Deviation (passband) is the programmable setting around which the setpoint can be programmed to energize the relay inside or outside the deviation band.

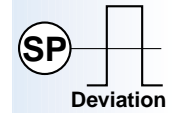

The deviation setting can be any value between 1 and 65535 counts. The number of counts selected act both positively and negatively on the setpoint, forming a deviation band around the setpoint.

For example, if the setpoint setting is 1000 counts and the deviation setting is 35 counts, the deviation band around the setpoint setting is 70 counts starting at 965 counts and ending at 1035 counts.

See Figure 14 – Example 2 for details of deviation with the relay energizing inside and outside the setpoint value.

[0X5] Relay Energizes Above SP Value

With **0** selected in the 1st digit, the relay energizes **inside** the deviation band (setpoint \pm deviation counts), then de-energizes **outside** the deviation band (setpoint \pm deviation counts).

[1X5] Relay Energizes Below SP Value

With **1** selected in the 1st digit, the relay energizes **outside** the deviation band (setpoint \pm deviation counts), then de-energizes **inside** the deviation band (setpoint \pm deviation counts).

Deviation

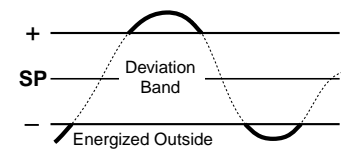
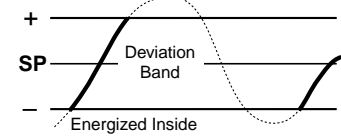

Deviation with Initial Start Up Inhibit

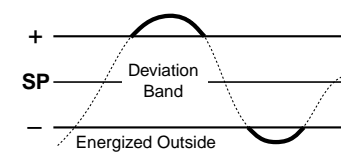
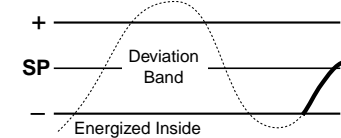

Figure 13 – Deviation Delay

[2X5] Relay Energizes Above SP Value With Initial Start-up Inhibit

With **2** selected in the 1st digit, the relay energizes **inside** the deviation band (setpoint \pm deviation counts), then de-energizes **outside** the deviation band (setpoint \pm deviation counts). With **falling input signal initial start-up inhibit**, the signal activates then de-activates the setpoint, and only when the setpoint activates for the second time, when the signal comes into the deviation band, does the relay energize.

[3X5] Relay Energizes Below SP Value With Initial Start-up Inhibit

With **3** selected in the 1st digit, the relay energizes **outside** the deviation band (setpoint \pm deviation counts), then de-energizes **inside** the deviation band (setpoint \pm deviation counts). With **rising input signal initial start-up inhibit**, the signal activates then de-activates the setpoint, and only when the setpoint activates for the second time, when the signal goes outside the deviation band, does the relay energize.

Relay Energize with Deviation Examples

Figure 14 – Example 2 shows the relay energize functions with deviation applied with and without initial start-up inhibit.

EXAMPLES Relay Energize Functions – DEVIATION Mode

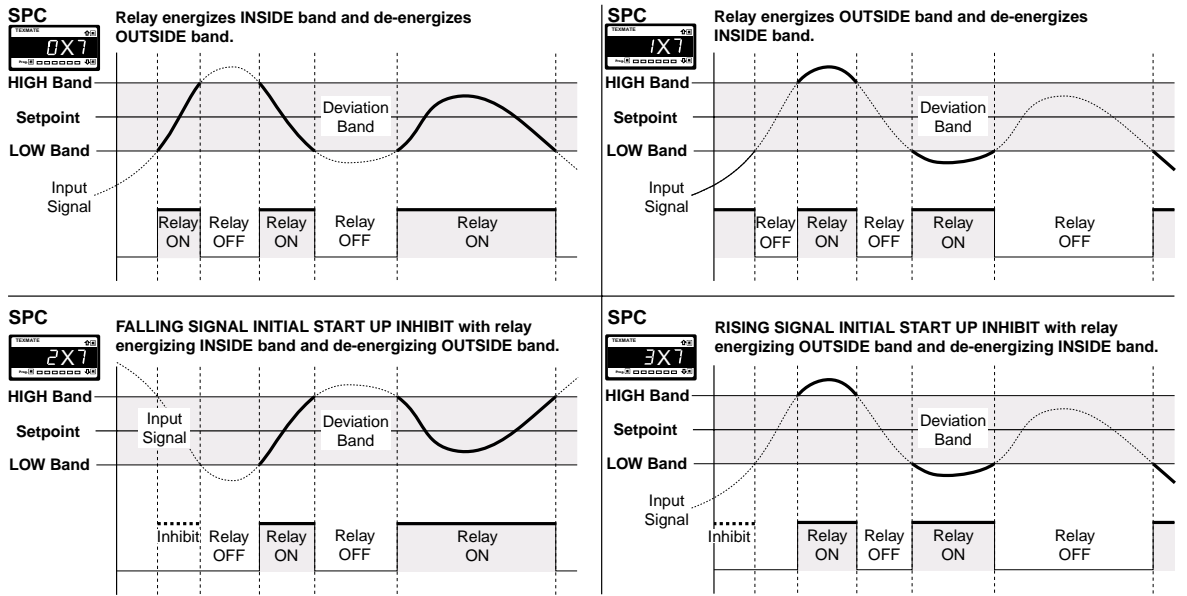
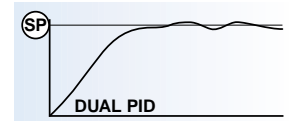

Figure 14 – Example 2: Relay energize functions with deviation

PID Control Settings

The PID (proportional, integral, derivative) control function provides exceptional control stability during control process applications.



PID control is available from the following outputs:

- Setpoint / relay output.
- Analog output.
- Relay and analog output at the same time.

PID control from the setpoint / relay output is available from SP1 and SP2 only.

There are two PID control outputs available via the analog output:

- PID1 – stored in register 50.
- PID2 – stored in register 51.

See Figure 15

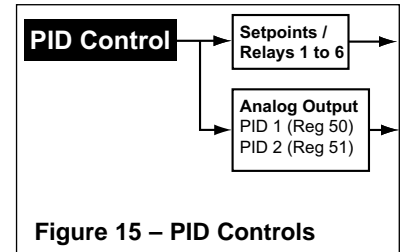

Figure 15 – PID Controls

[0X5] Relay Energizes Above SP Value

With 0 selected in the 1st digit, PID controls **down to** the setpoint value.

[1X5] Relay Energizes Below SP Value

With 1 selected in the 1st digit, PID controls **up to** the setpoint value.

[2X5] Relay Energizes Above SP Value With Initial Start-up Inhibit

With 2 selected in the 1st digit, PID controls **down to** the setpoint value.

[3X5] Relay Energizes Below SP Value With Initial Start-up Inhibit

With 3 selected in the 1st digit, PID controls **up to** the setpoint value.

See Figure 16. The individual control elements of PID control must be adjusted to suit each particular process.

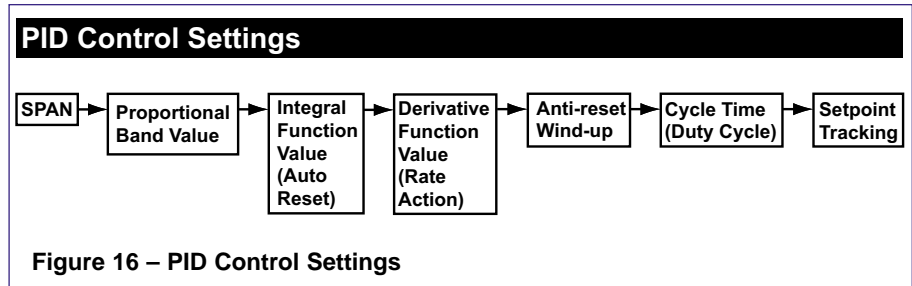

Span

The span can be adjusted from 0 to 99999 counts.

Proportional Band (PB)

The proportional band is expressed as a percentage of the full input range and can be adjusted from 0 to 999.9%. The setpoint value is the midpoint of the proportional band.

Integral Value (I)

Processes with long time delays and large maximum rate of rise require wide proportional bands to eliminate oscillation. Due to changes in load, wide proportional bands can result in large offsets. The integral value eliminates the large offsets. The integral value can be adjusted from 0 to 9999.9 seconds.

Derivative Value (D)

For processes with rapid changes in load, the derivative value, or rate action, reduces the amount of overshoot or undershoot of the process variable relative to the setpoint. The derivative value can be adjusted from 0 to 999.9 seconds.

Anti-reset Wind-up (ARW)

Anti-reset wind-up disables the integral control if the process input falls outside the ARW band. The band is defined as a % of the proportional band (PB). This stops the controller from winding itself up during times of large input error. For example, during warm up and times when the output may be intentionally disconnected.

Cycle Time

The cycle time is the total length of time for the instrument to complete one on/off cycle. The cycle time can be adjusted from 0 to 1000.0 seconds.



Note:

The output from Relay 1 is disabled if the cycle time is set to 0 seconds.

Relay Energize with PID Examples

Figure 17 – Examples 3 and 4 show the PID mode with the relay energized above and below the setpoint.

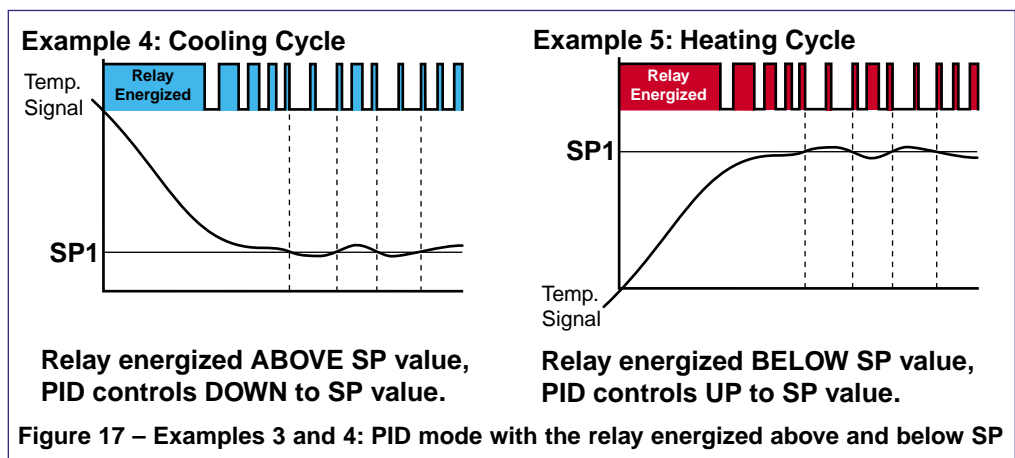

Relay energized ABOVE SP value, PID controls DOWN to SP value.

Relay energized BELOW SP value, PID controls UP to SP value.

Figure 17 – Examples 3 and 4: PID mode with the relay energized above and below SP

Display Flashing

Display flashing can be applied to setpoints configured in the hysteresis or deviation modes. Each setpoint can be programmed to make the display flash on and off while the setpoint is active, and keep it flashing until the setpoint de-activates.

Setpoint Tracking

Setpoint tracking can be applied to setpoints configured in the hysteresis, deviation, or PID modes.



Setpoint tracking allows one or more setpoints to follow a master setpoint (the setpoint being tracked) by a programmed positive or negative value.

If the value of the master setpoint is adjusted, the tracking setpoint follows the master setpoint by the previously programmed positive or negative value.

See Figure 18. For example, the master setpoint is set to 100 and the tracking setpoint has a positive tracking value of 5. The master setpoint activates when the signal reaches 100 but the tracking setpoint activates when the signal reaches 105.

If the master setpoint's activation value is adjusted to say 110, then the tracking setpoint automatically adjusts to 115.

In another example, the master setpoint is set to 100 and the tracking setpoint has a negative tracking value of 15. The master setpoint activates when the signal reaches 100 and the tracking setpoint activates when the signal reaches 85.

Again, if the master setpoint's activation value is adjusted to say 110, then the tracking setpoint automatically adjusts to 95.

The tracking setpoint tracks the absolute value of the master setpoint, but is not affected by any of the master setpoint's control modes.

The tracking setpoint retains its own setpoint control mode settings.

The tracking setpoint can be configured to activate in one of the following relay energize modes:

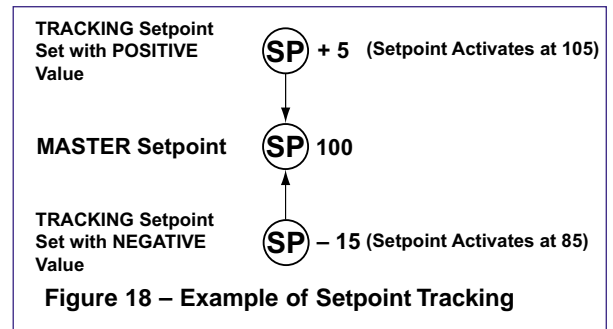

- **First digit set to 0 [0XX].**

Activate **ABOVE** (relay energized) and de-activate **BELOW** (relay de-energized) the tracking setpoint value.

- **First digit set to 1 [1XX].**

Activate **BELOW** (relay energized) and de-activate **ABOVE** (relay de-energized) the tracking setpoint value.

In most practical cases the source signal of the tracking setpoint must be set to the same source signal as the master setpoint. This is set in the setpoint and relay control function settings menu [SPC_X] [X1X].

Each setpoint can be programmed in one of the following tracking settings:

- OFF = No setpoint tracking.
- 1 = SPX tracks SP1.
- 2 = SPX tracks SP2.
- 3 = SPX tracks SP3.
- 4 = SPX tracks SP4.
- 5 = SPX tracks SP5.
- 6 = SPX tracks SP6.

Level 2 – 3rd Digit: Timers

Selecting [XX6] and pressing the [P] button enters the Level 2 setpoint control mode and makes the following timer modes available for further programming. Each relay can be individually programmed to operate in one of the following timer modes, energizing above or below the setpoint value:

- Normal Mode.
- Three Normally OFF/Pulsed ON Modes:
 - Repeat ON mode.
 - Pulse ON mode.
 - 1-Shot ON mode.
- Three Normally ON/Pulsed OFF Modes:
 - Repeat OFF mode.
 - Pulse OFF mode.
 - 1-Shot OFF mode.

All timer modes have timer delay resolution of 0.1 up to 6553.5 seconds. The **pulse ON**, **pulse OFF**, **repeat ON**, and **repeat OFF** modes have selectable timer delay resolution settings on SP1 and SP2 of 0.1 to 6553.5 seconds, or 0.001 to 65.535 seconds.

Individual settings can be programmed for all required setpoints. Setpoints not required in this mode can be set to OFF.

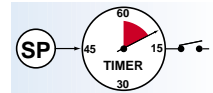

THIRD DIGIT	
SP Delay & Timing Functions	
0 No Latching	
1 Setpoint Latched	
2 Manual Relay Reset	
3 Setpoint Latched with Manual Relay Reset	
4 Setpoint Latched Off	
5 Hysteresis, Deviation & PID Mode (includes SP Tracking)	
6 Timer Modes:	
• Normal Delay.	
• Repeat ON.	
• Pulse ON.	
• 1-Shot ON.	
• Repeat OFF.	
• Pulse OFF.	
• 1-Shot OFF.	
<i>Note:</i> In PID mode, all functions on SP1 set in [XX6] are not functional.	
<i>Note:</i> [XX5] and [XX6] are set up procedure settings only. To finish, reset to 0-4 as required for setpoint latching and relay reset modes.	



Programming Tip

If you do not require any of the functions in this mode, ensure it is set to:

timer OFF

Third digit set to [XX6]

[XX6] [timer] [OFF]

Reset SPC_X to [XX0]

Normal Mode
Single Actuation

[norm] [P]

[dom] [00] [P] [dob] [00] [P] [XX6] [P]

Delay-on-make (DOM) time 0.1 to 6553.5 secs
Delay-on-break (DOB) time 0.1 to 6553.5 secs

1-Shot ON Mode
Single Actuation

[1shot] [P]

[dom] [00] [P] [on] [00] [P] [XX6] [P]

DOM 0.1 to 6553.5 secs
Minimum on-time (M_on) 0.1 to 6553.5 secs

Normally OFF/Pulsed ON Modes

These are time control modes where the relay is normally OFF (de-energizes) and pulses ON (energizes) when the setpoint activates.

Pulse ON Mode
Single Actuation

[pulse] [RES] [0.1] [P]

[dom] [00] [P] [on_t] [00] [P] [XX6] [P]

Resolution setting applies to SP1/SP2 ONLY [0001] [P]
DOM 0.1/0.001 to 6553.5/65.353 secs
Maximum on-time (on_t) 0.1/0.001 to 6553.5/65.353 secs

Repeat ON Mode
Multiple Actuation

[repe] [RES] [0.1] [P]

[off_t] [00] [P] [on_t] [00] [P] [XX6] [P]

Resolution setting applies to SP1/SP2 ONLY [0001] [P]
Off-time (off_t) 0.1/0.001 to 6553.5/65.353 secs
On-time (on_t) 0.1/0.001 to 6553.5/65.353 secs

Normally ON/Pulsed OFF Modes

These are time control modes where the relay is normally ON (energizes) and pulses OFF (de-energizes) when the setpoint activates.

1-Shot OFF Mode
Single Actuation

[-1shot] [P]

[off] [00] [P] [dob] [00] [P] [XX6] [P]

Minimum off-time (M_of) 0.1 to 6553.5 secs
dob 0.1 to 6553.5 secs

Pulse OFF Mode
Single Actuation

[-pulse] [RES] [0.1] [P]

[off_t] [00] [P] [dob] [00] [P] [XX6] [P]

Resolution setting applies to SP1/SP2 ONLY [0001] [P]
Maximum off-time (off_t) 0.1/0.001 to 6553.5/65.353 secs
DOB 0.1/0.001 to 6553.5/65.353 secs

Repeat OFF Mode
Multiple Actuation

[-repe] [RES] [0.1] [P]

[off_t] [00] [P] [on_t] [00] [P] [XX6] [P]

Resolution setting applies to SP1/SP2 ONLY [0001] [P]
Off-time (off_t) 0.1/0.001 to 6553.5/65.353 secs
on_t 0.1/0.001 to 6553.5/65.353 secs

Normal Mode

See Figures 19 and 20. This is a single actuation mode that individually programs the relay's setpoint with delay-on-make (DOM) and delay-on-break (DOB) settings.

When the SP deactivates, the DOB delay keeps the relay energized for the programmed time period.

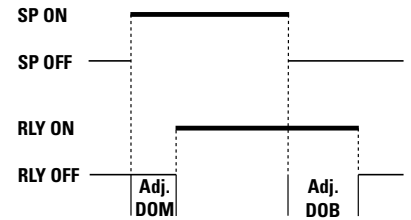

Figure 19 – Normal Mode



Note:

DOM and DOB settings can be programmed to zero. This allows for instant relay operation.

See Figure 20 – NORMAL Mode Time Control, for examples of the normal mode.

When the signal activates the setpoint, the DOM prevents the relay from energizing until the programmed DOM delay is complete. If the SP is active for less than the DOM time, the relay does not energize.

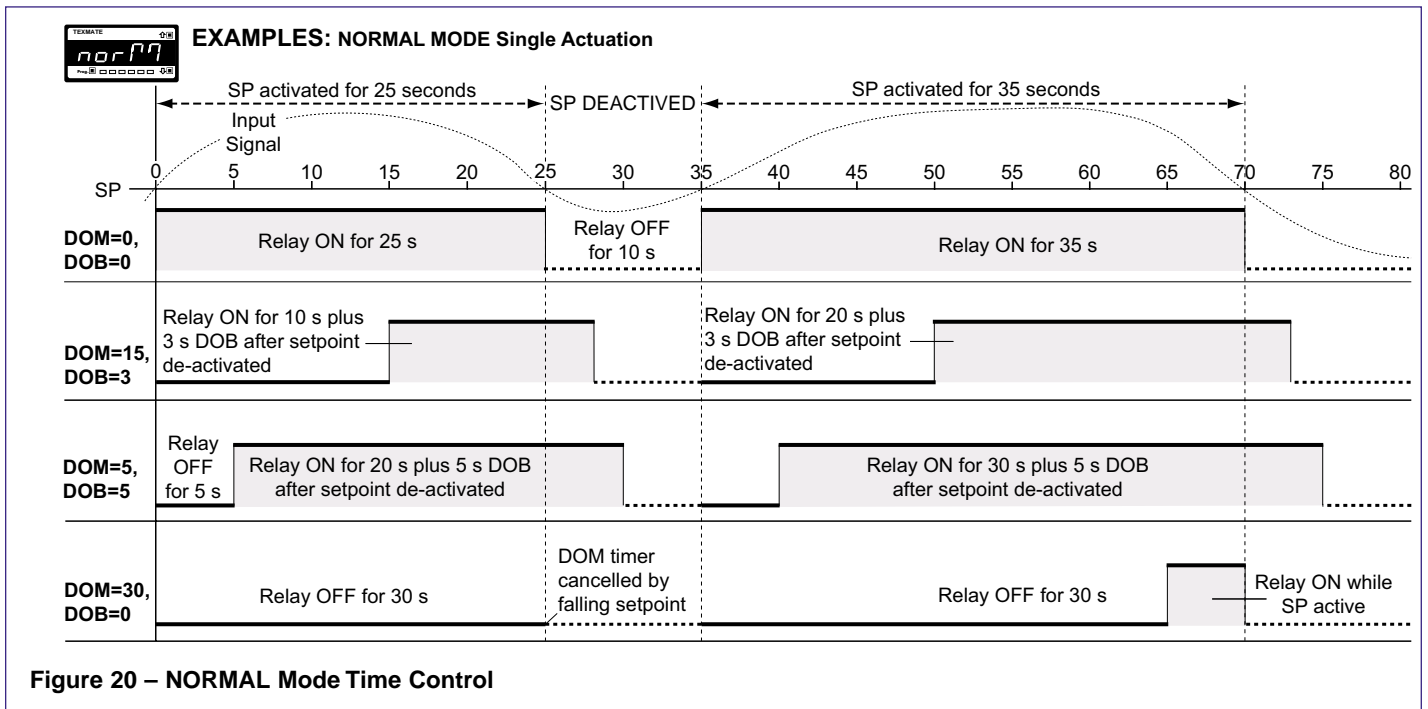

Figure 20 – NORMAL Mode Time Control

Normally OFF / Pulsed ON Modes

These are time control modes where the relay is normally OFF (de-energized) and pulses ON (energizes) when the setpoint activates.

Repeat ON Mode

See Figures 21 and 22. The repeat ON mode is a multiple actuation mode with programmable adjustable off-time and on-time settings.

In this mode the on-time setting activates first. When the signal activates the setpoint, the relay energizes immediately and remains energized for the programmed ON-T setting.

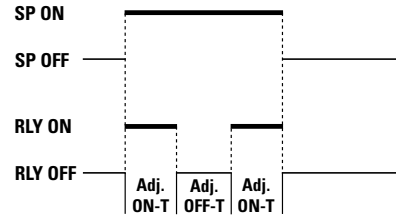

Figure 21 – Repeat ON Mode

When the ON-T delay is complete, the relay de-energizes and the OFF-T delay starts the cycle again. The ON-T and OFF-T settings continually repeat as long as the SP is active. If the SP deactivates, the relay de-energizes immediately.

See Figure 22 – REPEAT ON Mode Time Control, for examples of the repeat on mode.

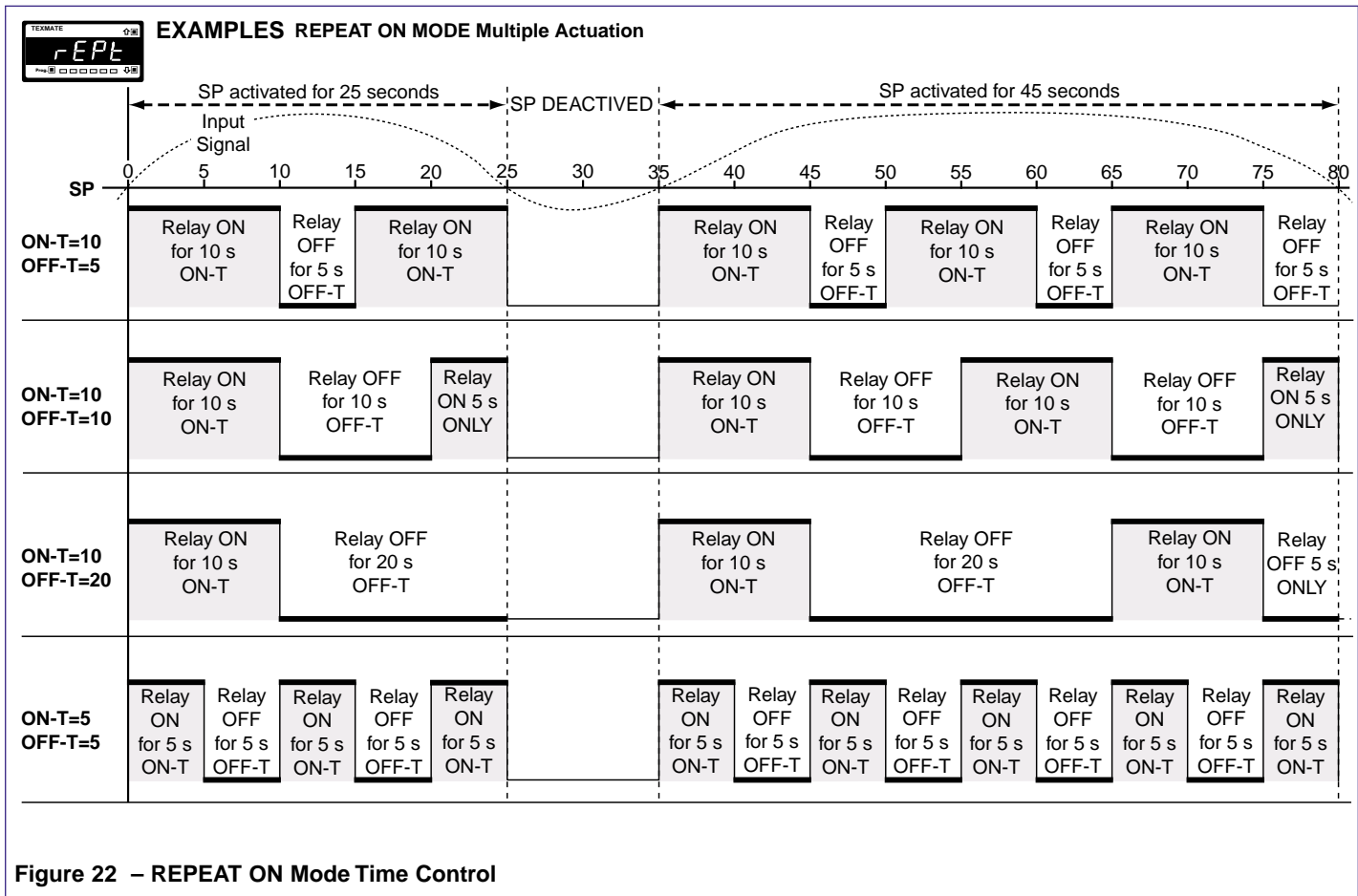

Figure 22 – REPEAT ON Mode Time Control

Pulse ON Mode (Programmable Maximum On-time)

See Figures 23 and 24. The pulse ON mode is a single actuation mode with programmable DOM and maximum on-time settings.

When the signal activates the setpoint, the DOM prevents the relay from energizing until the programmable DOM setting times out.

The ON-T then energizes the relay for the MAXIMUM programmed on-time period.

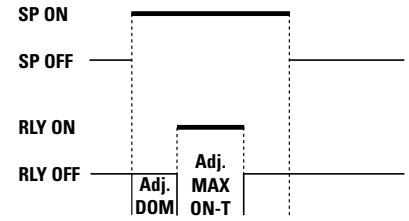

Figure 23 – Pulse ON Mode

For the pulse mode to repeat, the SP must deactivate and then activate again. If the SP deactivates, the maximum on-time setting keeps the relay energized until the ON-T times out.

See Figure 24 – PULSE ON Mode Time Control, for examples of the pulse on mode.

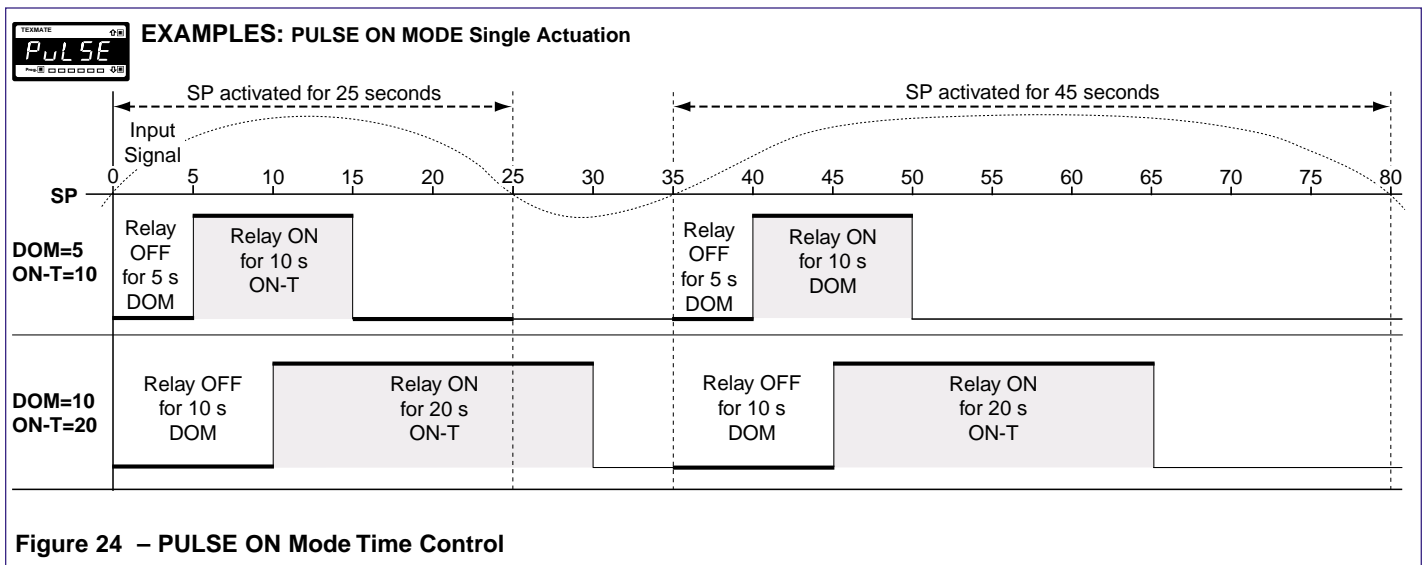

Figure 24 – PULSE ON Mode Time Control

1-Shot ON Mode (Programmable Minimum On-time)

See Figures 25 and 26. The 1-shot ON mode is a single actuation mode with programmable DOM and minimum on-time settings.

When the signal activates the setpoint, the DOM prevents the relay from energizing until the programmable setting times out.

The MIN-ON then energizes the relay for at least the minimum programmed on-time setting.

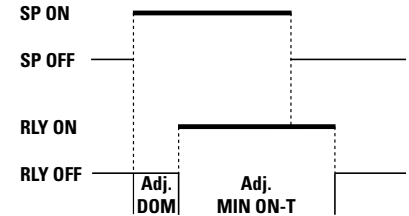

Figure 25 – 1-Shot ON Mode

If the SP deactivates, the relay remains energized for as long as the programmed MIN-ON period. If the SP remains active for longer than the MIN-ON period, the relay remains energized until the SP deactivates, at which point the relay de-energizes.

See Figure 26 – 1-SHOT ON Mode Time Control, for examples of the 1-shot on mode.

EXAMPLES: 1-SHOT ON MODE Single Actuation

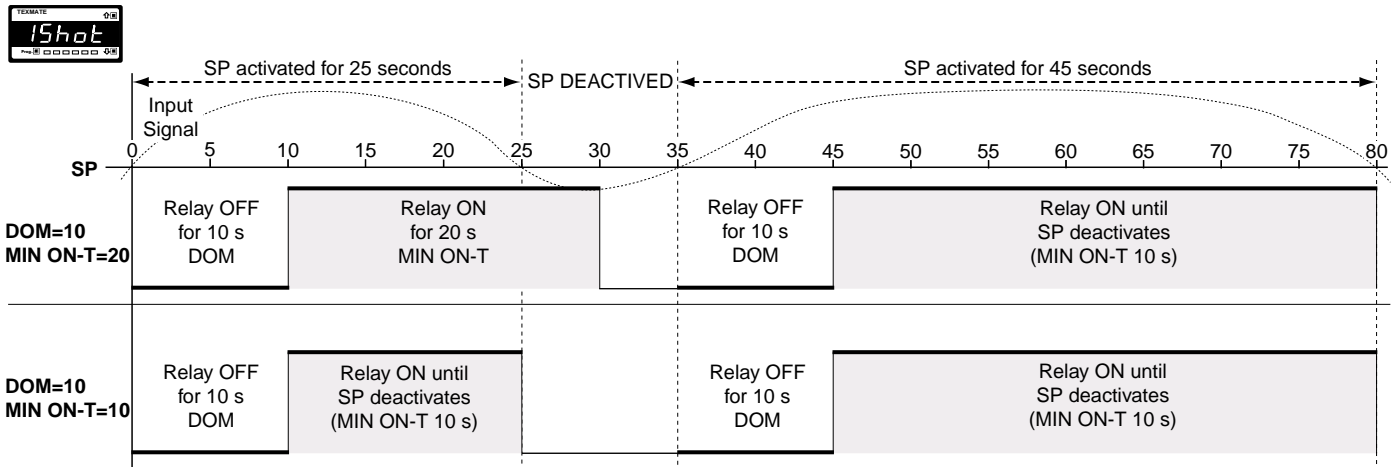

Figure 26 – 1-SHOT ON Mode Time Control

Normally ON / Pulsed OFF Modes

These are time control modes where the relay is **normally ON (energized)** and **pulses OFF (de-energizes)** when the setpoint deactivates.

1-Shot OFF Mode (Programmable Minimum Off-time)

See Figures 27 and 28. The 1-shot OFF mode is a single actuation mode with programmable DOB and minimum off-time settings.

When the signal deactivates the setpoint, the relay remains energized until the programmable DOB period times out.

The MIN OFF-T then de-energizes the relay for the minimum programmed off-time period.

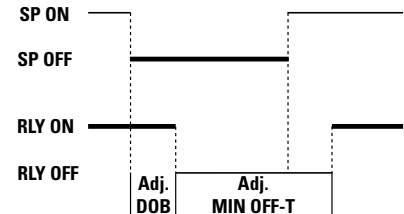

Figure 27 – 1-Shot OFF Mode

If the SP activates during the MIN OFF-T phase, the relay remains de-energized for as long as the programmed MIN OFF-T period and then energizes again.

See Figure 28 – 1-SHOT OFF Mode Time Control, for examples of the 1-shot off mode.

EXAMPLES: 1-SHOT OFF MODE Single Actuation

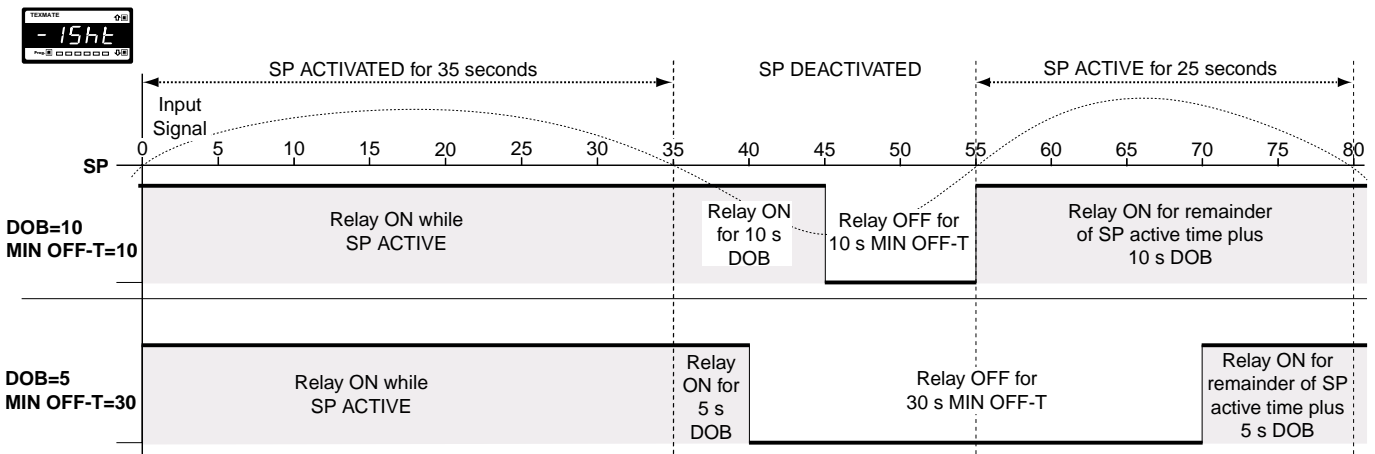

Figure 28 – 1-Shot OFF Mode Time Control

Pulse OFF Mode (Programmable Maximum Off-time)

See Figures 29 and 30. The pulse OFF mode is a single actuation mode with programmable DOB and maximum off-time settings.

When the signal deactivates the setpoint, the relay remains energized until the programmable DOB setting times out.

The OFF-T then de-energizes the relay for the MAXIMUM programmed off-time period.

For the pulse mode to repeat, the SP must activate and then deactivate again.

If the SP activates during the OFF-T phase, the relay remains de-energized until the OFF-T times out and then energizes.

See Figure 30 – PULSE OFF Mode Time Control, for examples of the pulse off mode.

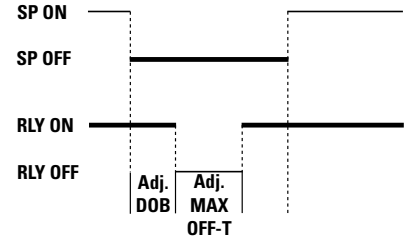
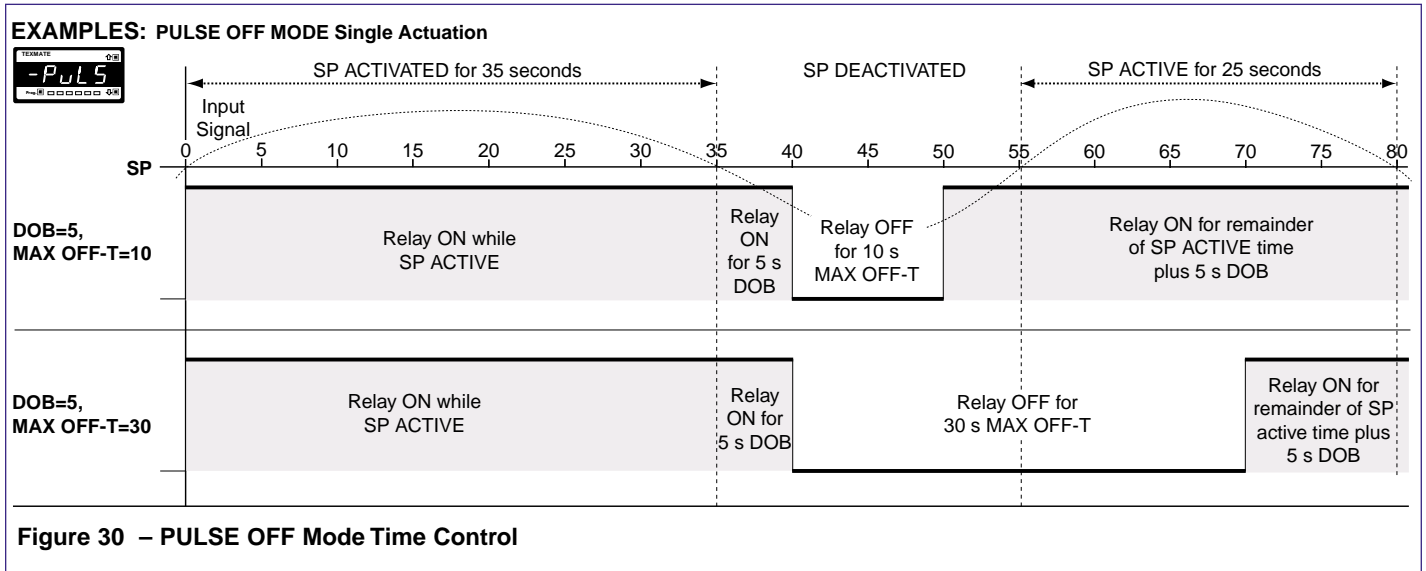

Figure 29 – Pulse OFF Mode



Repeat OFF Mode

See Figures 31 and 32. The repeat OFF mode is a multiple actuation mode with programmable off- and on-time settings.

In this mode the off-time setting activates first. When the signal deactivates the setpoint, the relay remains de-energized for the programmed OFF-T setting and energizes when the ON-T setting activates.

When the ON-T setting is complete, the relay de-energizes and the OFF-T delay starts the cycle again. The OFF-T and ON-T settings continually repeat as long as the SP is deactivated. If the SP activates, the relay energizes immediately.

See Figure 32 – REPEAT OFF Mode Time Control, for examples of the repeat off mode.

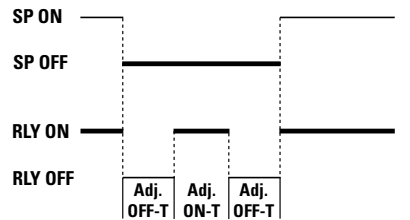
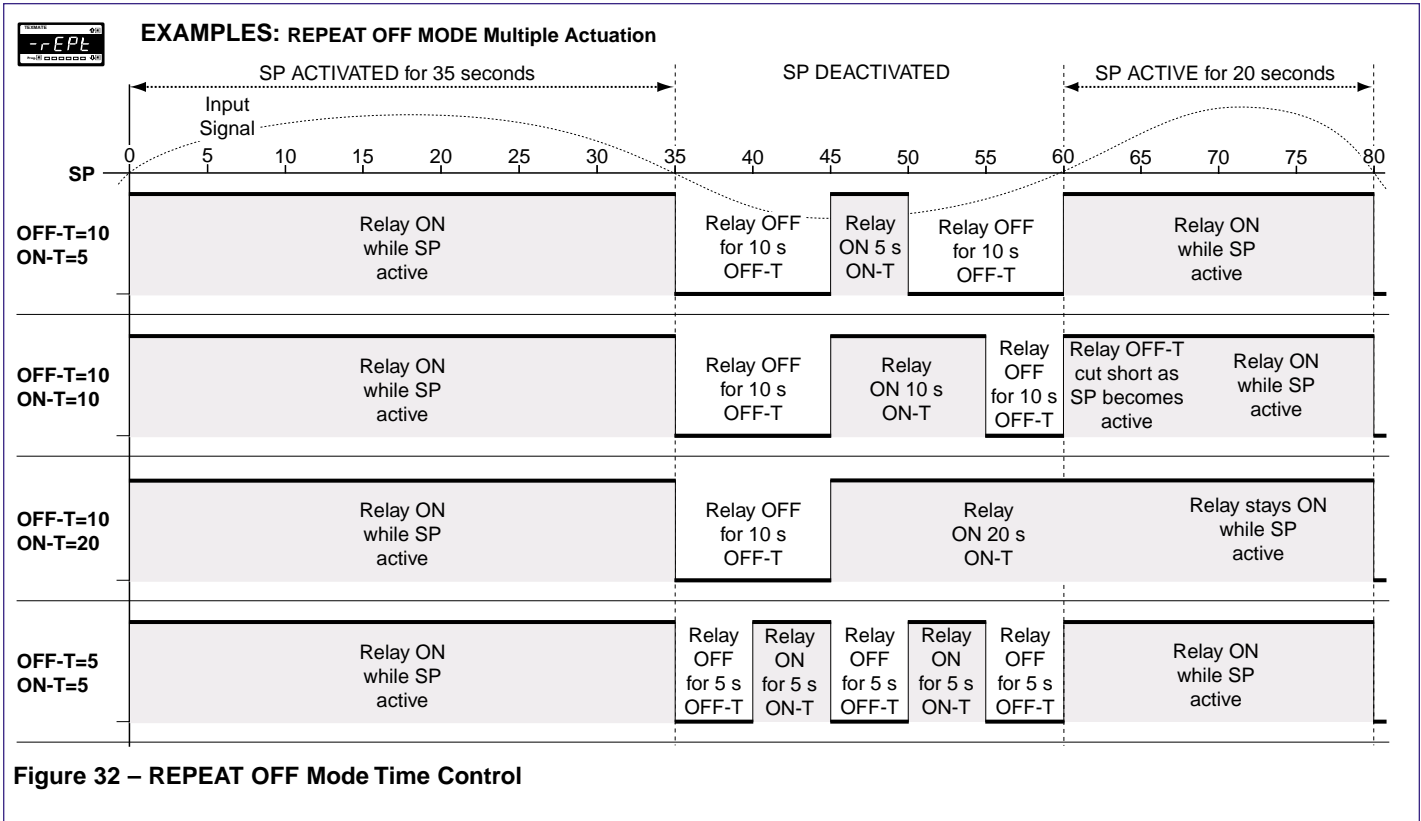

Figure 31 – Repeat OFF Mode



Level 2 – Example Configuration Procedures

Configure the setpoint activation values and the required setpoint control settings for Level 2.

Example – Setpoint Activation Values

See *Level 1 – Setpoint Activation Values: Example Procedure*.

Configuring the setpoint activation values is the same for Levels 1, 2, and 3. The example in Level 1 describes how to adjust the setpoint activation value for setpoint 1 to 10,000 counts. All other setpoint activation values are adjusted in the same way.

Example – Setpoint Control Settings

See *Level 2 – Hysteresis Mode: Example Procedure*.

See *Level 2 – PID Mode: Example Procedure*.

See *Level 2 – Timer Mode: Example Procedure*.

See *Level 2 – Select Setpoint Activation Source: Example Procedure*.

These examples describe how to configure setpoint 1 and 2 for the following Level 2 (intermediate) setpoint control operations.

Hysteresis

Configure setpoint 1 with **10** counts of **hysteresis**, display flashing **OFF**, and setpoint 1 to track setpoint 3.

PID

Configure setpoint 2 with the following PID settings:

- Set span to **20,000** counts.
- Set the Proportional Band Value to **10%** of span.
- Set the Integral Value to **10** counts.
- Set the Derivative Value to **5** counts.
- Set Anti-reset Wind-up to **10%**.
- Set the Cycle Time to **50** seconds.
- Set Setpoint Tracking to **OFF**.

Timer

Configure setpoint 1 for the following **normal mode** timer settings:

- Delay-on-make (DOM) = **15** seconds.
- Delay-on-break (DOB) = **3** seconds.

Setpoint Activation Source

Select channel 1 [**Ch 1**] as the activation source for setpoint 1.

Relay Energize and Latching Mode

Configure setpoint 1 to **energize** above the setpoint value.

Configure setpoint 1 with **relay latching with manual relay reset**.



Programming Tip

The individual modes in the 3rd digit of Levels 2 and 3 can be set to OFF, ensuring that no other functions are programmed and influencing your setup.

LEVEL 2 – Hysteresis Mode: Example Procedure

This example procedure describes how to configure SP1 in SPC_1 of the setpoint programming mode with 10 counts of **hysteresis**, display flashing **OFF**, and **SP1 to track SP3**.

START HERE

Configure Level 2 Hysteresis Mode Settings

Step 1
Enter Setpoint Programming Mode

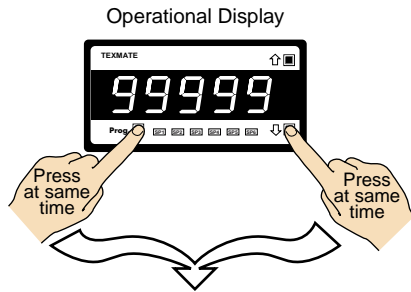

Step 2
Pass SP1 thru SP6 and enter SPC_1

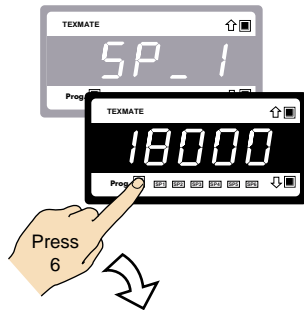

Step 3
Set SPC_2 to [XX5]:
1st Digit = X Not relevant to hysteresis, deviation & PID mode
2nd Digit = X Not relevant to hysteresis, deviation & PID mode
3rd Digit = 5 Selects hysteresis, deviation & PID mode

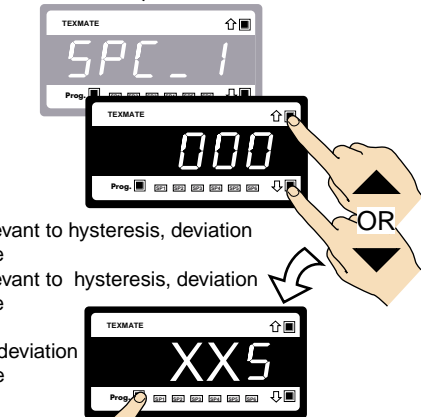

Step 4
Enter SP1 Hysteresis, Deviation, and PID mode sub-menu

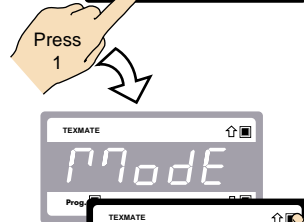

Step 5
Select [hYSt] as the SP1 mode. See diagram on Page 10

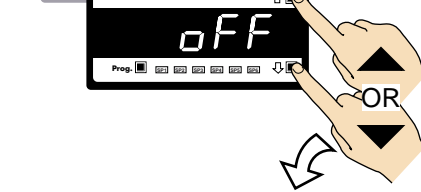

Step 6
Enter hysteresis control settings

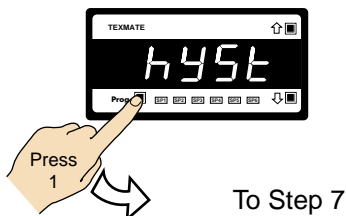

From Step 6

Step 7
Set the hysteresis setting

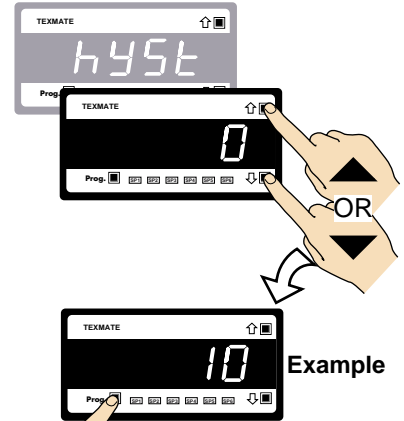

Step 8
Save the hysteresis setting

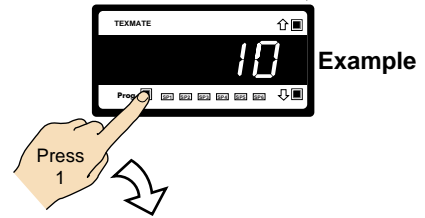

Step 9
Set the display flash setting to OFF

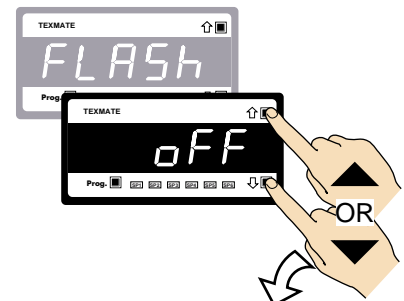

Step 10
Save the display flash setting

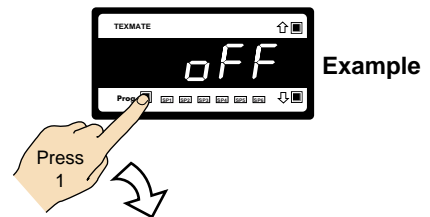

Step 11
Set SP1 to track SP3:
OFF= Tracking Off
1 = SP1 tracks SP1
2 = SP1 tracks SP2
3 = SP1 tracks SP3
4 = SP1 tracks SP4
5 = SP1 tracks SP5
6 = SP1 tracks SP6

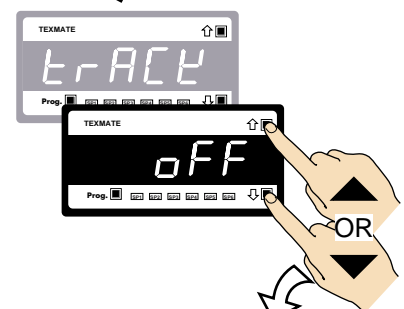

Step 12
Save the SP1 tracking settings

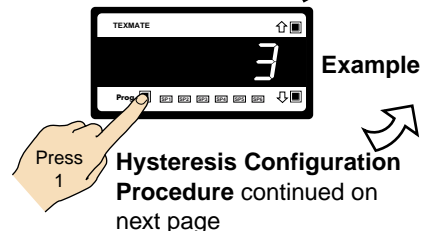

 **Hysteresis Configuration Procedure**
continued from bottom of previous page

Step 13

Reset 3rd digit to 0. If the 3rd digit is not reset to 0, the meter constantly cycles thru SPC_1

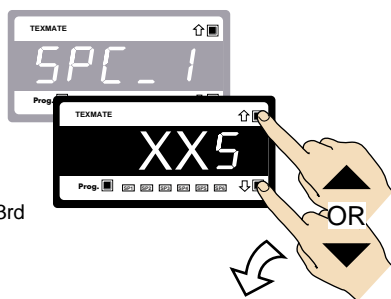

Step 14

Save SP1 control settings

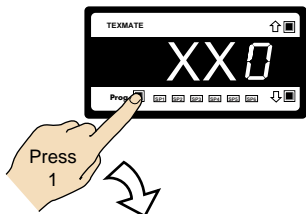

Step 15

Exit SPC_2 and return to operational display

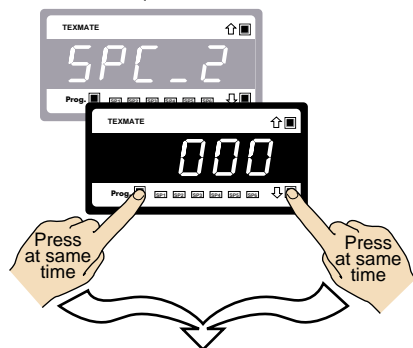

Operational Display

LEVEL 2 – PID Mode: Example Procedure

This example procedure describes how to configure SP2 for PID output in SPC_2 of the setpoint programming mode.

Note, PID is only available on SP1 and SP2. To configure SP1 for PID, carry out the same procedures in SPC_1 of the setpoint programming mode.

START HERE

Configure Level 2 PID Mode Settings

Step 1

Enter Setpoint Programming Mode

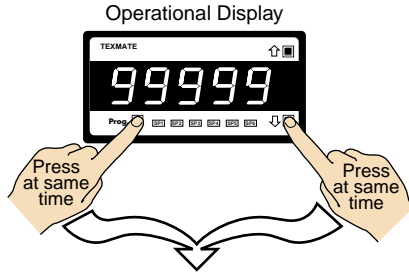

Step 2

Pass SP1 thru SP6 to SPC_1 and enter SPC_2

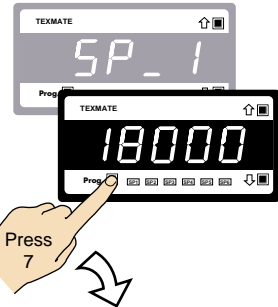

Step 3

Set SPC_2 to [XX5]:
 1st Digit = X Not relevant to PID mode
 2nd Digit = X Not relevant to PID mode
 3rd Digit = 5 Selects hysteresis, deviation & PID mode

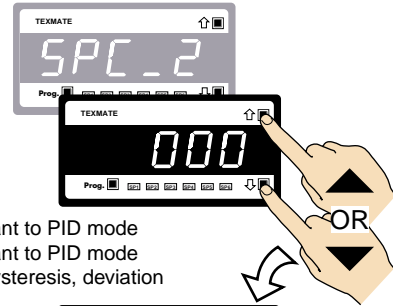

Step 4

Enter SP2 Hysteresis, Deviation, and PID mode sub-menu

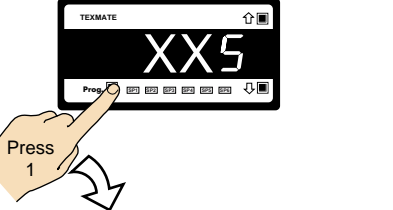

Step 5

Select [Pid] as the SP2 mode. See diagram on Page 11

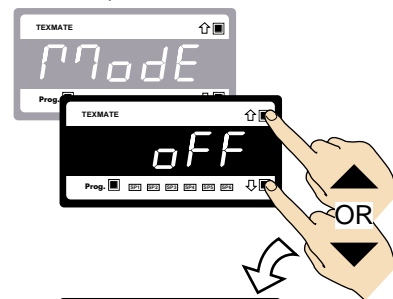

Step 6

Enter PID control settings

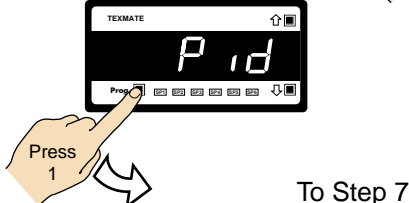

To Step 7

Example Note:

In the following example, all PID settings have been selected arbitrarily, it is recommended that all PID settings are correctly worked out beforehand.

From Step 6

Step 7

Set the span setting

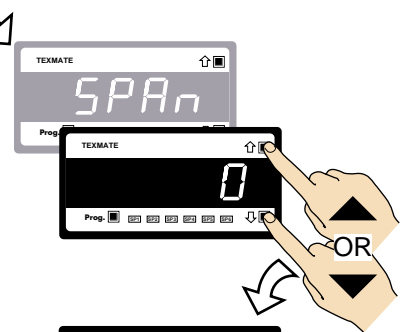

Step 8

Save the span setting

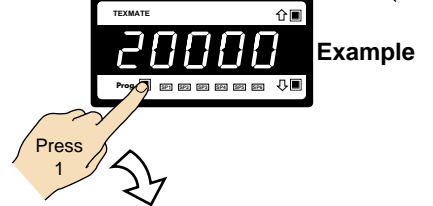

Step 9

Set the proportional band value:
 MIN 0%
 MAX 999.9%

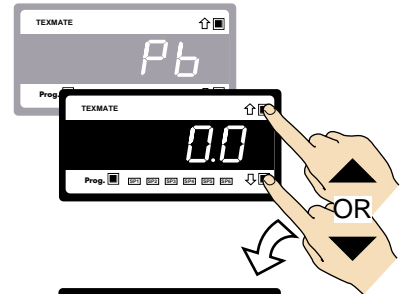

Step 10

Save the proportional band value

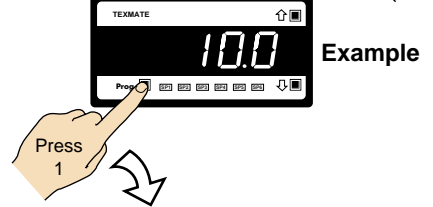

Step 11

Set the integral value:
 MIN 0
 MAX 999.9

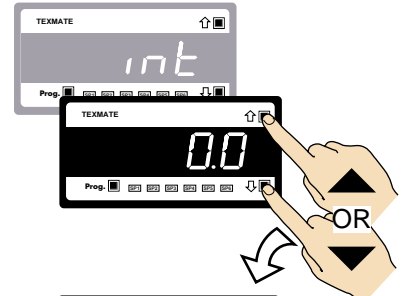

Step 12

Save the integral value

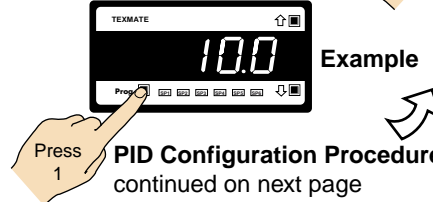

PID Configuration Procedure continued on next page

PID Configuration Procedure
continued from bottom of previous page

Step 13
Set the derivative value:
MIN 0
MAX 999.9

Example
Screenshot of the TEXMATE display showing '5.0'. A hand is shown pressing the right arrow key.

Step 14
Save the derivative value



Step 15
Set the anti-reset wind-up percentage of the proportional band value:
MIN 0.1%
MAX 100.0%

Example
Screenshot of the TEXMATE display showing '100'. A hand is shown pressing the right arrow key.

Step 16
Save the anti-reset wind-up percentage of the proportional band value



Step 17
Set the minimum cycle time in seconds:
MIN 0 secs
MAX 1000 secs

Note:
The output from relay 2 is disabled if the minimum cycle time is set to 0 secs.

Example
Screenshot of the TEXMATE display showing '10' and '500'. A hand is shown pressing the right arrow key.

Step 18
Save the minimum cycle time setting



To Step 19

From Step 18

Step 19
Set setpoint tracking to [oFF]:
oFF = Tracking oFF
1 = SP1 tracks SP1
2 = SP1 tracks SP2
3 = SP1 tracks SP3
4 = SP1 tracks SP4
5 = SP1 tracks SP5
6 = SP1 tracks SP6

Example
Screenshot of the TEXMATE display showing 'oFF'. A hand is shown pressing the right arrow key.

Step 20
Save setpoint tracking settings



Step 21
Reset 3rd digit to 0. If the 3rd digit is not reset to 0, the meter constantly cycles thru SPC_2

Example
Screenshot of the TEXMATE display showing 'XX0'. A hand is shown pressing the right arrow key.

Step 22
Save SP2 control settings

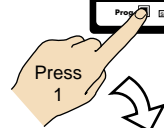

Step 23
Exit SPC_3 and return to operational display

Example
Screenshot of the TEXMATE display showing '99999'. A hand is shown pressing the right arrow key.

Operational Display

LEVEL 2 – Timer Mode: Example Procedure

This example procedure describes how to configure SP1 with normal mode delay-on-make (DOM) and delay-on-break (DOB) timer settings.

START HERE

Configure Level 2 Timer Mode Settings

Step 1
Enter Setpoint
Programming
Mode

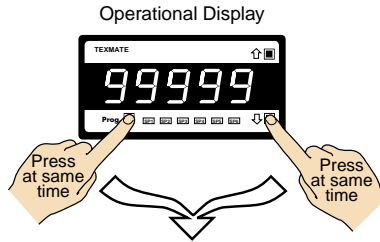

Step 2
Pass SP1 thru SP6
and enter SPC_1

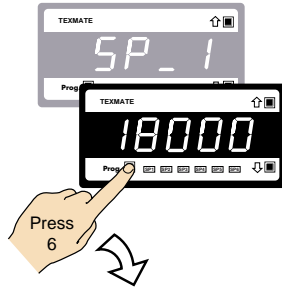

Step 3
Set SPC_1 to [XX6]:
1st Digit = X Not relevant to TIMER mode
2nd Digit = X Not relevant to TIMER mode
3rd Digit = 6 Selects TIMER mode

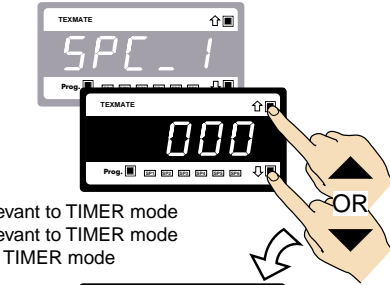

Step 4
Enter SP1 Timer
mode sub-menu

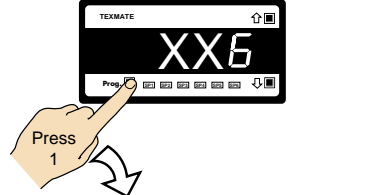

Step 5
Select [norM] as the
SP1 TIMER mode. See
diagram on Page 11

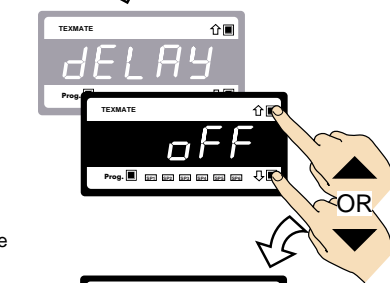

Step 6
Enter normal timer
control settings

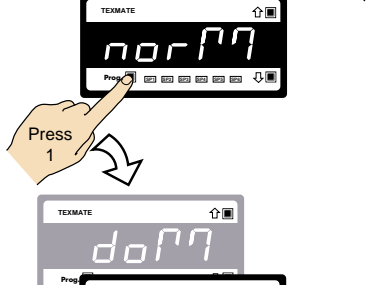

Step 7
Set the DOM
(delay-on-make)
setting to 15 seconds

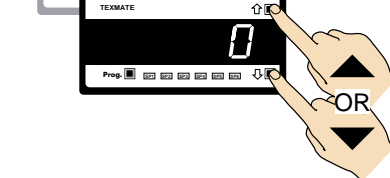

From Step 7

Step 8
Save the
DOM setting

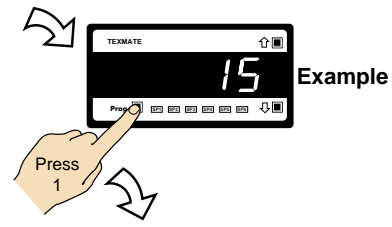

Step 9
Set the DOB
(delay-on-break)
setting to 3 seconds

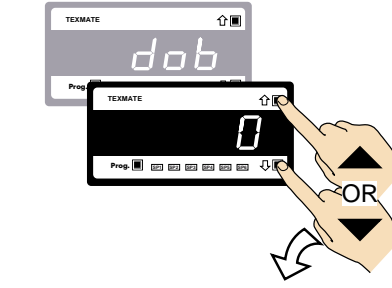

Step 10
Save the
DOB setting

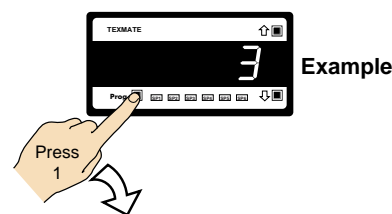

Step 11
Reset 3rd digit to 0. If the
3rd digit is not reset to 0,
the meter constantly
cycles thru SPC_1

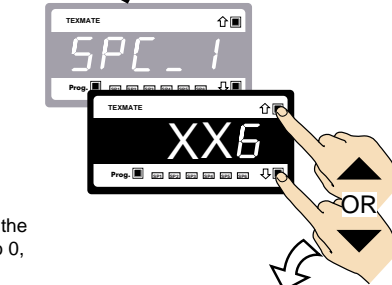

Step 12
Save the SP1
control settings

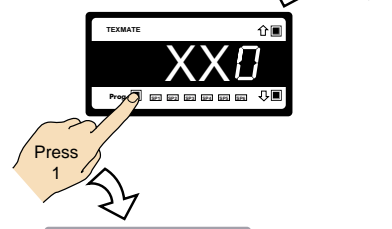

Step 13
Exit SPC_2 and return
to operational display

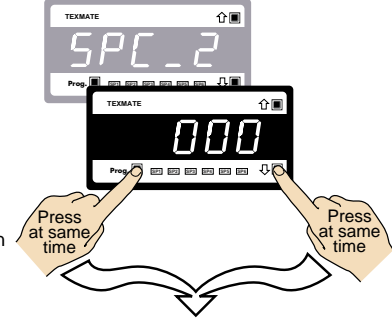

To Step 8



LEVEL 2 – Select Setpoint Activation Source: Example Procedure

This is a combined procedure to configure the following for SP1:

- Relay energize setting.
- Setpoint activation source setting.
- Relay latching setting.

START HERE

Configure Level 2 Setpoint Activation Source

Step 1

Enter Setpoint Programming Mode

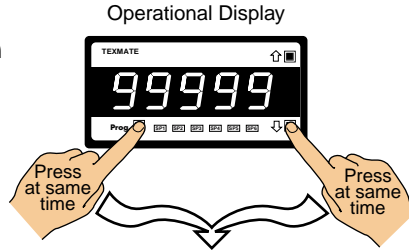

Step 2

Pass thru SP1 to SP6 and enter SPC_1

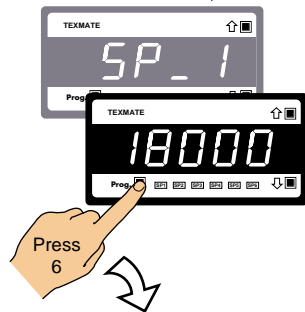

Step 3

Set SPC_1 to [013]:
 1st Digit = 0 Energize above SP1 value
 2nd Digit = 1 Select data source for SP1
 3rd Digit = 3 Relay latching with manual reset

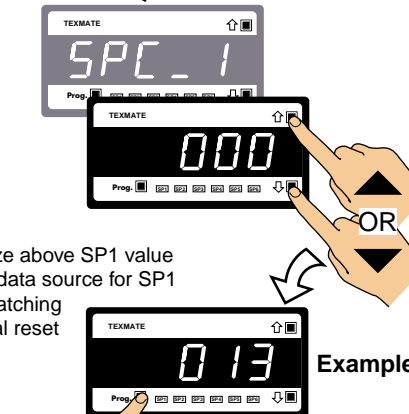

Step 4

Enter SP1 source sub-menu

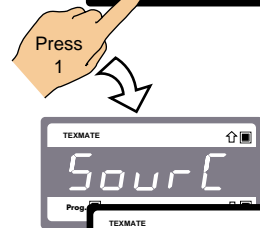

Step 5

Select [Ch1] as the SP1 activation source. See Select Data Source diagram below

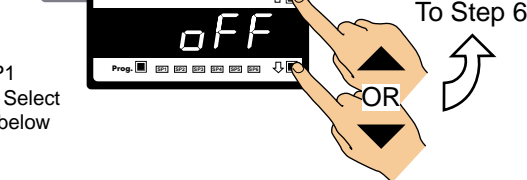

From Step 5

Step 6
Save SP1 control settings

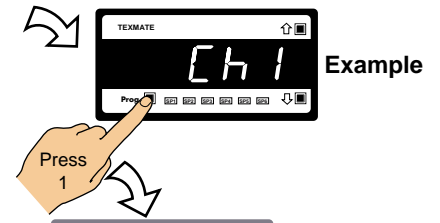

Step 7

Reset 2nd digit to 0 (This activates the setpoint source from the selected register). If the 2nd digit is not reset to 0, the meter will constantly cycle thru SPC_1

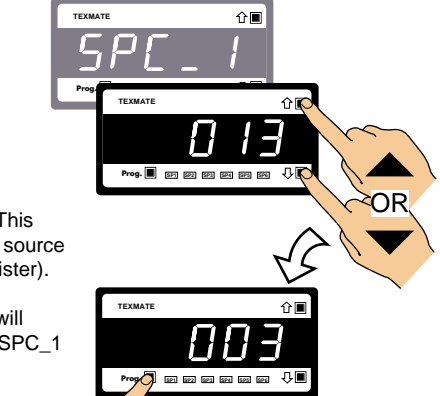

Step 8

Save SP1 control settings

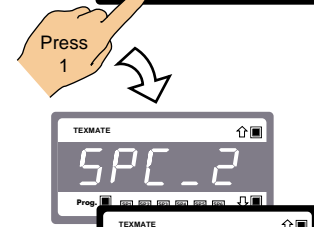

Step 9

Exit SPC_2 and return to operational display

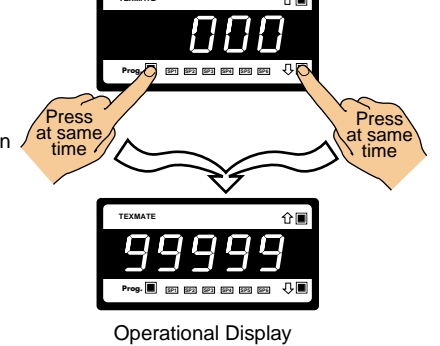

Select Data Source



Use the [↑] [↓] buttons to cycle through the options

[diSP]
[↑] [↓]

[rESL1] [↑] [↓] [Ch1] [↑] [↓] [Ch2] [↑] [↓] [Ch3] [↑] [↓] [Ch4] [↑] [↓] [tot_1] [↑] [↓] [tot_2] [↑] [↓] [PEAK] [↑] [↓] [VALEY] [↑] [↓] [tArE]

Use the [↑] [↓] buttons to select register number as data source for setpoint. [1 to 244]

This Page intentionally left blank



Level 3 – Advanced Mode

Level 3 – Relay and Setpoint Configuration Sequence

When configuring each setpoint for Level 3 settings, the following programming sequence must be followed to ensure that all configuration settings are correctly entered and saved:

START HERE

- 1 Enter the Setpoint Programming Mode**

Press the **[F]** and **[M]** buttons at the same time. This enters the setpoint programming mode. The display toggles between [SP_1] and [18000].
- 2 Adjust Setpoint Activation Values**

Use the **[F]** and **[M]** buttons to adjust the setpoint 1 (SP1) activation value. If not SP1, press the **[F]** button to move to the required setpoint and then adjust.
Adjust all other applicable setpoint activation values as required (SP2 to SP6).
- 3 Select Setpoint Control Function Settings**

After all required setpoint activation values have been adjusted, press the **[F]** button until [SPC_1] appears. SPC_1 is the setpoint control function programming menu for setpoint 1. Set the three digits in the following order:

LEVEL 3 – ADVANCED FUNCTIONS

- 1) Third Digit – Configure Hysteresis, Deviation & PID Settings [XX5]**

If **hysteresis, deviation, or PID** is required, set to [XX5]. Press the **[F]** button to enter the **Hysteresis, Deviation & PID Mode** sub-menu and program the hysteresis, deviation, or PID settings as required.

When complete, reset back to [XX0].
- 2) Third Digit – Configure Timers [XX6]**

If a **timer** is required, set to [XX6]. Press the **[F]** button to enter the **Timer Modes** sub-menu, select and program one of seven time control modes as required for SP1.

When complete, reset back to [XX0].
- 3) Third Digit – Configure Advanced Reset & Trigger Functions [XX7]**

If advanced reset and trigger functions are required, set to [XX7]. Press the **[F]** button to enter the **reset and trigger functions mode** sub-menu and program the reset and trigger functions mode as required.

When complete, reset back to [XX0].
- 4) First Digit – Select Relay Energize Mode**

Select the **relay energize mode and initial start-up inhibit setting** for SP1 from either [0XX] to [3XX].
- 5) Second Digit – Select Setpoint Activation Source [X1X]**

Press the **[F]** button to enter the sub-menu and select the setpoint activation source for SP1 from any channel or selected register. When complete, reset back to [000].

If the SP source is from an **external switched input** (digital input pin), set to one of either [X2X] to [X7X] to select the setpoint activation source from one of six digital inputs (2 to 7).
- 6) Third Digit – Relay Latching & Manual Reset Functions**

Select the **relay latching and manual reset functions** from either [XX0] to [XX4] as required.

4

Record All Setpoint Programming Code Settings

Enter all SP1 activation and control values in the Table: *Customer Code Settings – Setpoint Programming Mode* on Page 15 of the *Tiger 320 Series Programming Code Sheet (NZ101)*.

5

Repeat Setpoint Control Function Settings for all Applicable Setpoints

Press the [P] button to move to [SPC_2]. SPC_2 is the setpoint control function programming menu for setpoint 2 (SP2).

Repeat Steps 3 and 4 for all applicable setpoints.

6

Exit the Setpoint Programming Mode

Press the [P] button to save a setpoint programming mode setting and then press the [P] and [D] buttons at the same time to return to the operational display.

END HERE

Setpoint & Relay Control Settings Diagram

The following diagram shows the setpoint and relay three digit control function settings for operational Levels 1, 2, and 3.

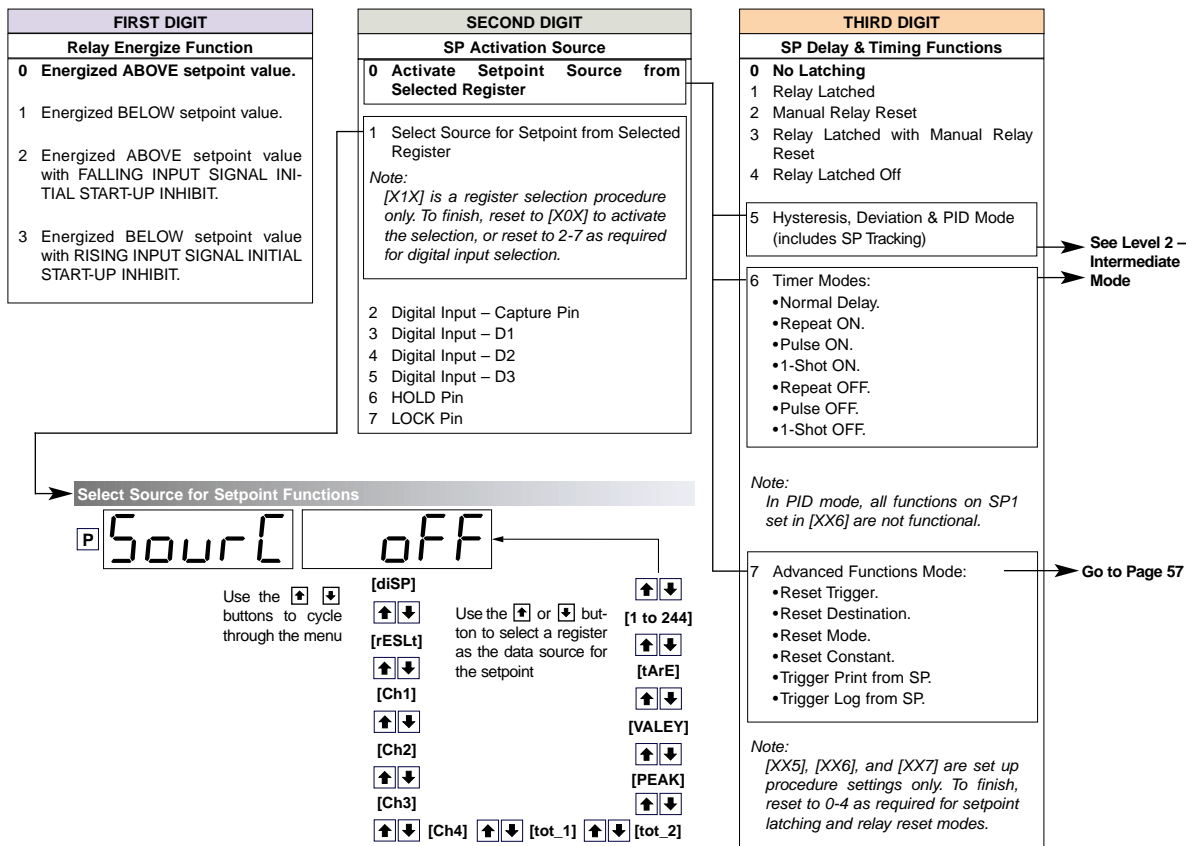

Level 3 – 1st Digit: Relay Energize Functions

The settings and functionality of the 1st digit in Level 3 remains the same as Level 2. The 1st digit allows you to program the setpoint relay to energize **above** or **below** the setpoint value. These settings are further controlled by the mode selected when the third digit is set to [XX5]. One of the following settings are then selected:

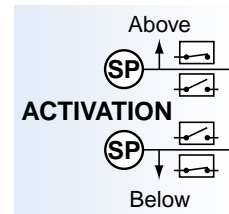

- Hysteresis.
See Page 32 for further details.
- Deviation.
See Page 34 for further details.
- PID.
See Page 35 for further details.

The hysteresis and deviation modes can also be programmed to energize the relay with or without **initial start-up inhibit**.

See Page 30 for further details.

FIRST DIGIT
Relay Energize Function
0 Energized ABOVE setpoint value.
1 Energized BELOW setpoint value.
2 Energized ABOVE setpoint value with FALLING INPUT SIGNAL INITIAL START-UP INHIBIT.
3 Energized BELOW setpoint value with RISING INPUT SIGNAL INITIAL START-UP INHIBIT.

Level 3 – 2nd Digit: Setpoint Activation Source

The settings and functionality of the 2nd digit remain the same for Levels 1, 2, and 3. The **setpoint activation source** must be programmed for all required setpoints.

See Level 1 – 2nd Digit: Setpoint Activation Source for further details.

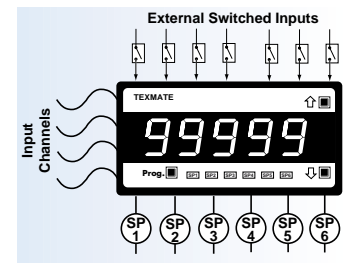

Level 3 – 3rd Digit: Latching and Reset

The settings and functionality of the **3rd digit latching and reset functions** remain the same for Levels 1, 2, and 3.

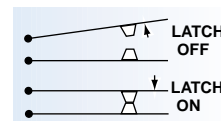

Selecting [XX0] to [XX4] allows you to program the setpoint for one of five relay latching and manual reset modes.

THIRD DIGIT
SP Delay & Timing Functions
0 No Latching
1 Setpoints Latched
2 Manual Relay Reset
3 Setpoints Latched with Manual Relay Reset
4 Setpoints Latched Off
5 -
6 -
7 -

See Level 1 – 3rd Digit: Latching and Reset for further details.

Level 3 – 3rd Digit: Hysteresis, Deviation, PID, & Timers

The settings and functionality of 3rd digit settings [XX5] and [XX6] remain the same for Levels 2, and 3. Individual settings can be programmed for all required setpoints. Setpoints not required in this mode can be set to OFF.

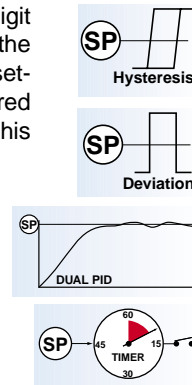

THIRD DIGIT	
SP Delay & Timing Functions	
0 No Latching	
1	Setpoint Latched
2	Manual Relay Reset
3	Setpoint Latched with Manual Relay Reset
4	Setpoint Latched Off
5 Hysteresis, Deviation & PID Mode (includes SP Tracking)	
6 Timer Modes:	
	<ul style="list-style-type: none"> •Normal Delay. •Repeat ON. •Pulse ON. •1-Shot ON. •Repeat OFF. •Pulse OFF. •1-Shot OFF.
<p><i>Note:</i> In PID mode, all functions on SP1 set in [XX6] are not functional.</p> <p><i>Note:</i> [XX5] and [XX6] are set up procedure settings only. To finish, reset to 0-4 as required for setpoint latching and relay reset modes.</p>	

Level 3 – 3rd Digit: Advanced Functions Mode

Selecting [XX7] and pressing the [P] button enters the **Advanced Functions Mode** menu and allows you to configure register reset and setpoint trigger functions. Individual settings can be programmed for all required setpoints. Setpoints not required in this mode can be set to OFF.

THIRD DIGIT	
SP Delay & Timing Functions	
0 No Latching	
1	Relay Latched
2	Manual Relay Reset
3	Relay Latched with Manual Relay Reset
4	Relay Latched Off
5 Hysteresis, Deviation & PID Mode (includes SP Tracking)	
6 Timer Modes:	
	<ul style="list-style-type: none"> •Normal Delay. •Repeat ON. •Pulse ON. •1-Shot ON. •Repeat OFF. •Pulse OFF. •1-Shot OFF.
<p><i>Note:</i> In PID mode, all functions on SP1 set in [XX6] are not functional.</p>	
7 Advanced Functions Mode:	
	<ul style="list-style-type: none"> •Reset Trigger. •Reset Destination. •Reset Mode. •Reset Constant. •Trigger Print from SP. •Trigger Log from SP.
<p><i>Note:</i> [XX5], [XX6], and [XX7] are set up procedure settings only. To finish, reset to 0-4 as required for setpoint latching and relay reset modes.</p>	

Third digit set to [XX7] P [tr 10] [OFF]

Select Trigger Setting

Selecting [OFF] in the Destination Register Reset Setup takes you to Setpoint Print Trigger Setup

Select Reset Destination Register: [MAKE] P [dEst] [OFF] P [Print] [OFF] P [Log] [OFF] P [XX7] [XX0]

Select Print Triggered by Setpoint: [on]

Select Log Triggered by Setpoint: [on]

Reset SPC to [XX0]

Select Reset Mode: [Mode] [Const] P [rESL] [0]

Select Reset Constant: [0]

Sets from 0 to -19999 (down arrow)
Sets from 0 to 99999 (up arrow)

Select [rEG] to access the source parameter to select the number of the Modbus register in the meter to be copied to the reset destination register

[Source] [OFF]

Use the [up] and [down] buttons to cycle through the menus

Use the [up] and [down] buttons to cycle through the register menu (1 to 244)

Use the [up] and [down] buttons to select a register as the data source for the setpoint (1 to 244)

Programming Tip

If you do not require any of the functions in this mode, ensure it is set to:

[tr 10] [OFF]

The Advanced Functions Mode menu allows you to program the following.

See also *Register Supplement (NZ209)* for details on registers used by setpoints.

See *LEVEL 3 – ADVANCED FUNCTIONS: Register Reset and Setpoint Trigger Functions* diagram above.

- SP** TRIGGER OPERATES ON:
 - MAKE EDGE
 - BREAK EDGE
 - MAKE & BREAK EDGE
 - EVERY SAMPLE PERIOD
- SP** RESET SELECTED REGISTER
- SP** TRIGGER PRINT
- SP** TRIGGER LOG DATA

Trigger

The trigger setting provides the option of selecting which edge of the relay operation the reset function, print function, and data logging function activates on. It can be set to:

- **Make** – Operate on the make edge only.
See *Figure 33* for further details.
- **Break** – Operate on the break edge only.
See *Figure 34* for further details.
- **Both** – Operate on both make and break edges.
See *Figure 35* for further details.
- **Level** – Operate after every sample period if relay is on.
See *Figure 36* for further details.

Make Edge Mode

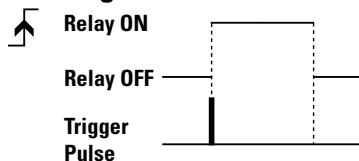

Figure 33 – Make Edge Mode

Break Edge Mode

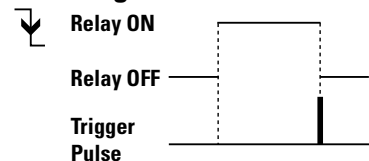

Figure 34 – Break Edge Mode

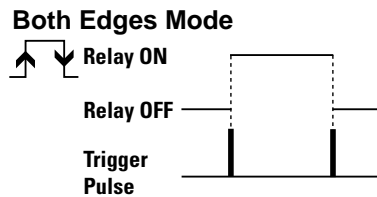

Figure 35 – Both Edges Mode

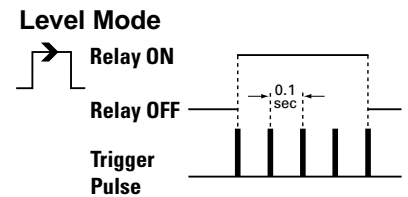

Figure 36 – Level Mode

Reset Destination Register

The reset destination setting defines the target register in the meter that is to be modified in some way when the reset trigger conditions for the relay are met. Any meter register number from 1 to 255 can be selected as a reset destination. If the destination [dEst] setting is set to [oFF], the reset function is disabled and the reset mode [ModE][ConSt] and reset constant/source [rES_C][SouRC] selections are not displayed. The setup sequence jumps straight to the print [Print] setting.

Reset Mode

The reset mode setting defines what type of reset effect is required. The following options are available:

- **[ConSt]** – This mode stores a user defined constant into the selected destination register. In most cases this number is zero, but it can be any number.
- **[I-S+C]** – This mode stores the current input value (I), defined by the setpoint activation source, minus the setpoint value (S), plus a user defined constant (C). It would normally be used with a counting or totalising application where the amount of setpoint overshoot needs to be retained after the reset function. The constant value would normally be zero but could be used to provide an offset if required.
- **[D+C]** – This mode adds the user defined constant (C) to the current value in the selected reset destination register (D). It can be used to increment or decrement a register by any amount.
- **[Reg]** – This mode copies the contents of a user selectable register into the reset destination register (see note below in *Reset Constant* to select source register). It can be used to capture data on an event and store it in an unused channel for display or analog output etc.

Reset Constant

This setting defines the constant value to be used in the [ConSt], [I-S+C], [D+C] modes explained in *Reset Mode* above. It's default value is zero, but can be anywhere between -19999 and 99999. This setting is not available if [rEG] is selected as the reset mode.

Source

If the reset mode is set to [rEG] the source parameter allows you to select the number of the ASCII/Modbus register in the meter to be copied to the reset destination register.

Trigger Print from Setpoint

When set to [on], the setpoint can be programmed to print data when the selected trigger condition is satisfied.

The print only occurs if the serial mode has been set to Print Mode in Code 3, 3rd digit.



Note:

The trigger setting for the programmed setpoint is common to the reset function, the print function, and the log function.

Trigger Log Data from Setpoint

When set to [on], the setpoint can be programmed to log data when the selected trigger condition is satisfied.

The log only occurs if data logging has been enabled in Code 8, 1st digit.



Note:

The trigger setting for the programmed setpoint is common to the reset function, the print function, and the log function.

Level 3 – Example Configuration Procedures

Configure the setpoint activation values and the required setpoint control settings for Level 3.

Example – Setpoint Activation Source

See *Level 1 – Setpoint Activation Values: Example Procedure*.

Configuring the setpoint activation values is the same for Levels 1, 2, and 3. The example in Level 1 describes how to adjust the setpoint activation value for setpoint 1 to 10,000 counts. All other setpoint activation values are adjusted in the same way.

Example – Setpoint Control Settings

Configuring the hysteresis, deviation, PID, timer, and relay energize and latching function values is the same for Levels 2, and 3. The following examples describe how to configure setpoints 1 and 2 in Level 2, but can also be used for Level 3:

See *Level 2 – Hysteresis Mode: Example Procedure*.

See *Level 2 – PID Mode: Example Procedure*.

See *Level 2 – Timer Mode: Example Procedure*.

See *Level 2 – Setpoint Activation Source: Example Procedure*.

The following example describes how to configure setpoints 5 and 6 for the following Level 3 (advanced) setpoint control operations:

See *Level 3 – Advanced Reset and Trigger Functions: Example Procedure*.



Programming Tip

The individual modes at Levels 2 and 3 can be set to OFF, ensuring that no other functions are programmed and influencing your setup.

Hysteresis

Configure setpoint 1 with **10** counts of **hysteresis**, display flashing **OFF**, and setpoint 1 to track setpoint 3.

PID

Configure setpoint 2 with the following PID settings:

- Set span to **20,000** counts.
- Set the Proportional Band Value to **10%** of span.
- Set the Integral Value to **10** counts.
- Set the Derivative Value to **5** counts.
- Set Anti-reset Wind-up to **10%**.
- Set the Cycle Time to **50** seconds.
- Set Setpoint Tracking to **OFF**.

Timer

Configure setpoint 1 for the following **normal mode** timer settings:

- Delay-on-make (DOM) = **15** seconds.
- Delay-on-break (DOB) = **3** seconds.

Advanced Modes

As the reset and trigger functions are advanced modes, we have used a Texmate customer application as an example to describe how to configure the meter for reset and trigger functions.

Example Application

Texmate's customer has a stonecrusher and requires the meter to download peak data and reset the peak for each stroke of the crusher.

The example describes how to configure setpoint 5 to reset peak, and setpoint 6 to download the data after each stroke to a PC running a Terminal program:

1 SETPOINT 5 USED TO RESET PEAK

- 1) Set SPC_5 to [X1X].
Set SOURCE to CH1.
- 2) Set SPC_5 to [XX5].
 - Set mode to **hysteresis**.
 - Set hysteresis to **0**.
 - Set flash to **OFF**.
 - Set track to **6** (SP5 tracks SP6).
- 3) Set SPC_5 to [XX7].
 - Set reset trigger to [MAKE].
 - Set reset destination register to [Peak].
 - Set reset mode to [ReG].
 - Set reset source to CH1.
 - Set Trigger print by setpoint = [oFF].
 - Set Trigger log by setpoint [oFF].
- 4) Reset SPC_5 to [XX0] to leave this menu.

2 SETPOINT 6 CONTROLS THE PRINT FUNCTION

- 1) Set SPC_6 to [X1X].
Set SOURCE to CH1.
- 2) Set SPC_6 to [XX7].
 - Set reset trigger to [BrEAK].
 - Set reset destination register to [oFF].
 - Set trigger print by setpoint to [on].
 - Set trigger log by setpoint to [oFF].

3 ACTIVATE THE PRINT MODE

- 1) Set Code 3 to [XX3].
Set SOURCE to CH1.

4

- 1) Connect to your PC and run a Windows Terminal program to download the PEAK data.
See Serial Communications Output Module Supplement for details.



General Programming Tips for All Level 2 and Level 3 Setpoint Control Functions

Level 2 modes [XX5] and [XX6] and Level 3 mode [XX7] require the third digit to be reset to one of five third digit settings: [XX0] to [XX4]. If not, the mode will constantly cycle through the setpoint and relay control setting [SPC_X].

Generally, the third digit should be reset to [XX0] unless specific relay latching or manual relay reset functions are required. In which case [XX1] to [XX4] should be selected. See *Setpoints & Relay Control Settings Diagram* on Page 55.

Setpoint Activation Source

Select channel 1 [Ch 1] as the activation source for setpoint 1.

Relay Energize Mode

Configure setpoint 1 to **energize** above the setpoint value.

Configure setpoint 1 with **relay latching with manual relay reset**.

LEVEL 3 – Advanced Reset and Trigger Functions : Example Procedure

This example procedure describes how to configure setpoints 5 and 6 for Level 3 (advanced) reset and trigger functions.

START HERE

Configure Level 3 Reset & Trigger Mode Settings

CONFIGURE SP5 TO RESET PEAK

Step 1
Enter Setpoint Programming Mode

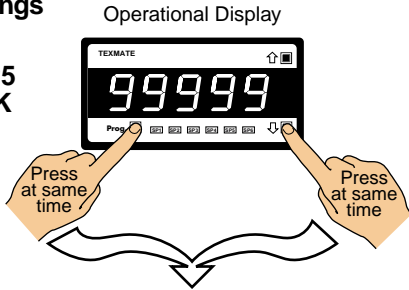

Step 2
Pass SP1 thru to SPC_4 and enter SPC_5

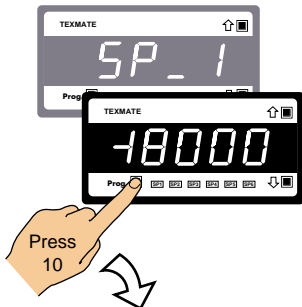

Step 3
Set SPC_5 to [X1X]:
1st Digit = X Not relevant to reset & trigger mode
2nd Digit = 1 Select data source for SP5
3rd Digit = X Not relevant to reset & trigger mode

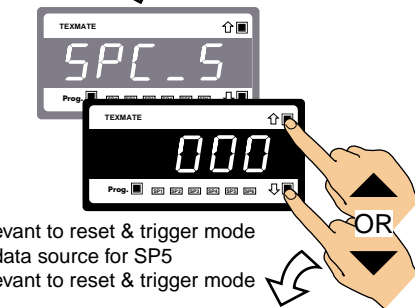

Step 4
Enter SP5 source sub-menu

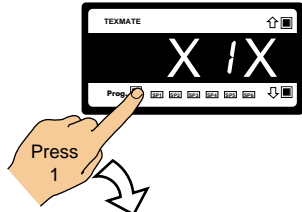

Step 5
Select [Ch1] as the SP5 Activation Source. See diagram below

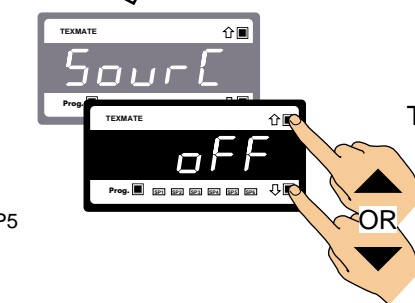

From Step 5

Step 6
Save SP5 Activation Source setting

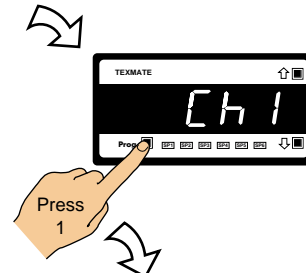

Step 7
Set SPC_5 to [XX5]:
1st Digit = X Not relevant to reset & trigger mode
2nd Digit = X Not relevant to reset & trigger mode
3rd Digit = 5 Hysteresis, Deviation & PID Mode

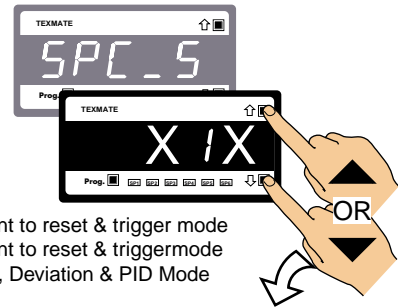

Step 8
Enter the Hysteresis, Deviation, and PID mode

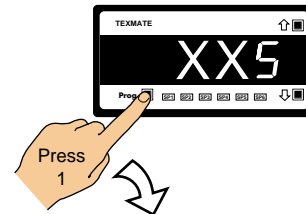

Step 9
Select [hYSt] as the SP5 mode. See diagram on Page 10

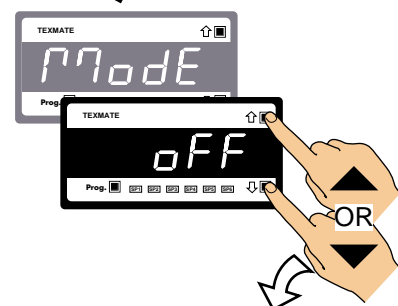

Step 10
Enter Hysteresis control setting

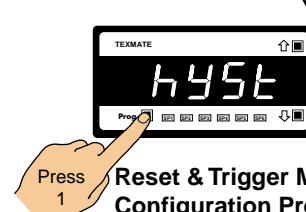

Reset & Trigger Mode Configuration Procedure continued on next page



Use the [↑] [↓] [diSP] buttons to cycle through the [rESL1] [Ch1] [Ch2] [Ch3] [Ch4] [tot_1] [tot_2] [PEAK] [VALEy] [tArE] options

Use the [↑] [↓] buttons to select register as data source for setpoint. [1 to 244]

Reset & Trigger Configuration Procedure
continued from bottom of previous page

Step 11
Ensure hysteresis is set to 0

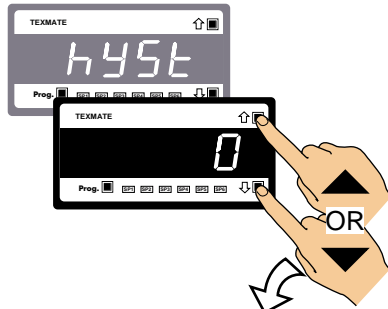

Step 12
Save the Hysteresis setting

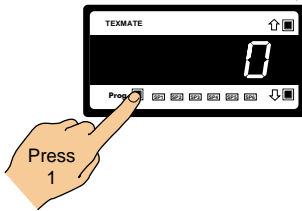

Step 13
Ensure [FLASh] is set to [oFF]

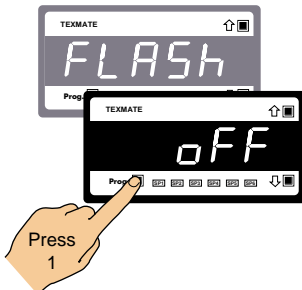

Step 14

Set SP5 to track SP6:
OFF = Tracking Off
1 = SP5 tracks SP1
2 = SP5 tracks SP2
3 = SP5 tracks SP3
4 = SP5 tracks SP4
5 = SP5 tracks SP5
6 = SP5 tracks SP6

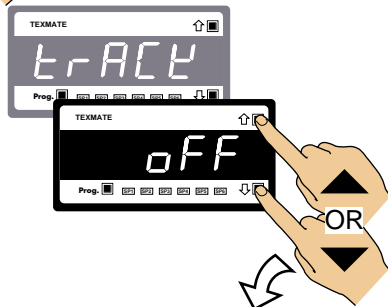

Step 15
Save the tracking setting

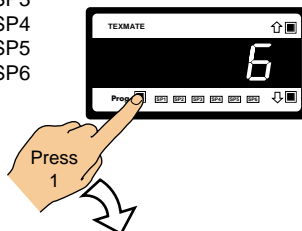

Step 16

Set SPC_5 to [XX7]:
1st Digit = X Not relevant to reset & trigger mode
2nd Digit = X Not relevant to reset & triggermode
3rd Digit = 7 Selects Advanced Functions Mode

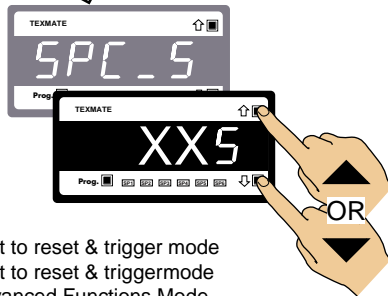

From Step 16

Step 17
Enter Advanced Functions Mode

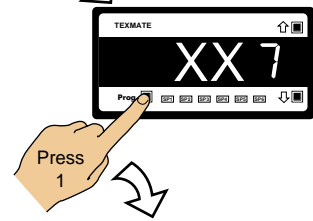

Step 18
Select [MAKE] as the SP5 Reset Trigger. See diagram on Page 11

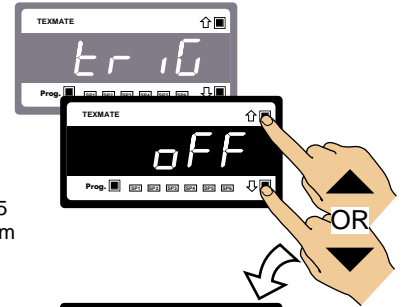

Step 19
Save Reset Trigger setting

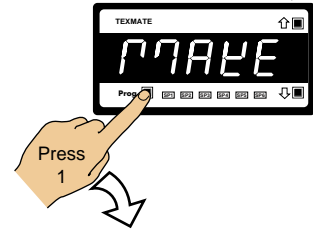

Step 20
Select [PEAK] as the Reset Destination Register

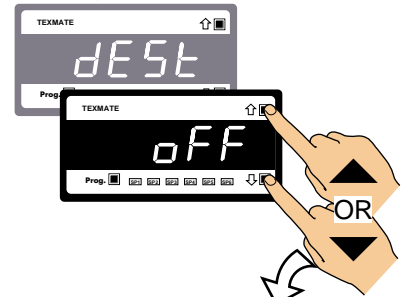

Step 21
Save Reset Destination Register setting

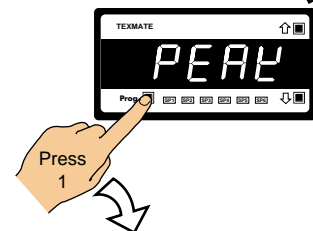

To Step 17

Step 22
Select [rEG] as the Reset Mode setting

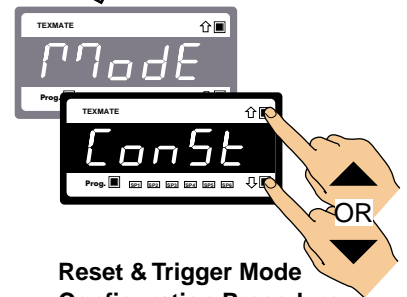

Reset & Trigger Mode Configuration Procedure
continued on next page

Reset & Trigger Configuration Procedure
continued from bottom of previous page

Step 23
Save the Reset Mode setting

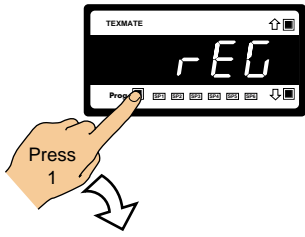

Step 24
Select [Ch1] as the Reset Source setting

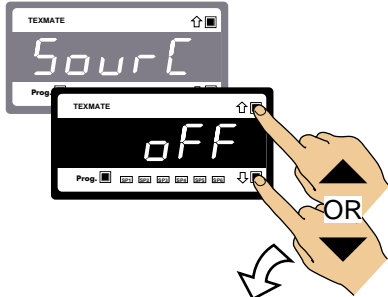

Step 25
Save the Reset Source setting

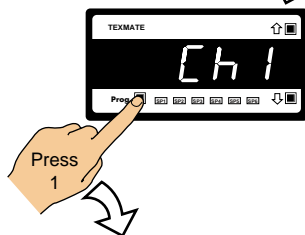

Step 26
Ensure [Print] is set to [oFF]

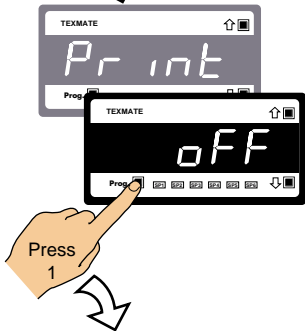

Step 27
Ensure [Log] is set to [oFF]

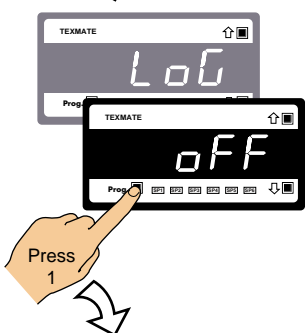

Step 28
Reset 3rd digit to 0. If the 3rd digit is not reset to 0, the meter constantly cycles thru SPC_5

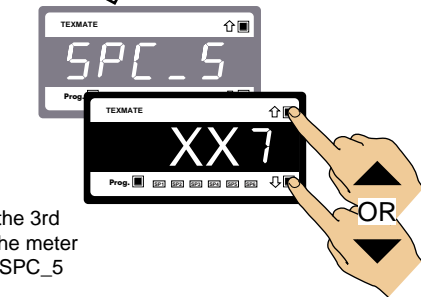

From Step 28

Step 29
Exit SPC_5 and enter SPC_6

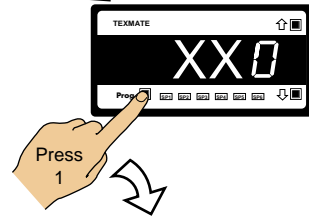

CONFIGURE SP6 TO PRINT PEAK

Step 30

Set SPC_6 to [X1X]:
1st Digit = X Not relevant to Select Source mode
2nd Digit = 1 Select Source for SP Mode
3rd Digit = X Not relevant to Select Source mode

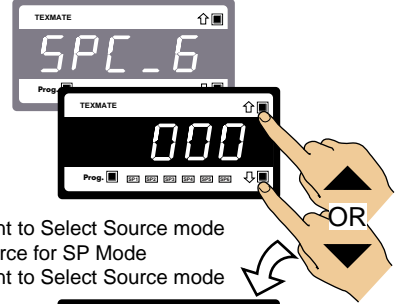

Step 31
Enter SP6 Select Source menu

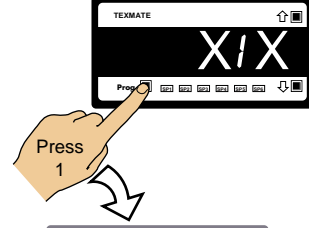

Step 32
Select [Ch1] as the SP6 activation source. See Select Data Source diagram on Page 41.

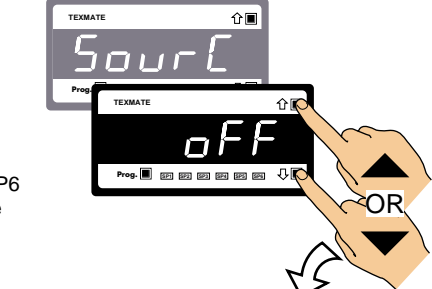

Step 33
Save Reset Destination Register setting

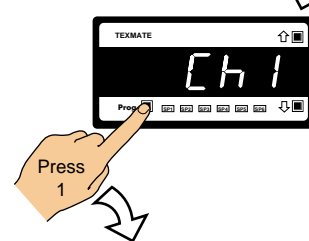

To Step 29
Step 34

Set SPC_6 to [XX7]:
1st Digit = X Not relevant to reset & trigger mode
2nd Digit = X Not relevant to reset & trigger mode
3rd Digit = 7 Selects Advanced Functions Mode

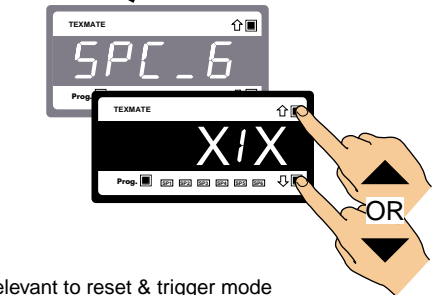

Reset & Trigger Mode Configuration Procedure
continued on next page

Reset & Trigger Configuration Procedure
continued from bottom of previous page

Step 35
Enter Advanced
Functions Mode

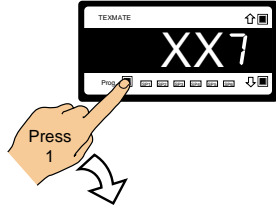

Step 35
Select [brEAK] as the SP6
Reset Trigger. See diagram
on Page 11

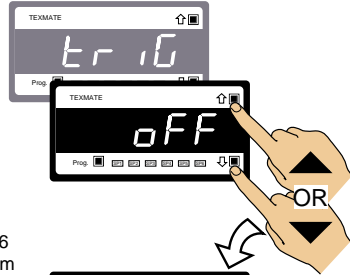

Step 36
Save Reset
Trigger setting

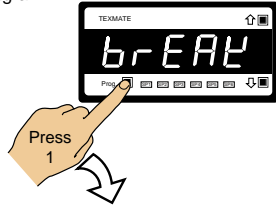

Step 37
Ensure Reset
Destination
Register set to [OFF]

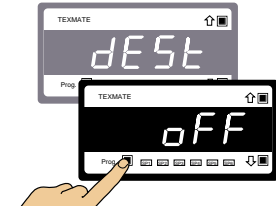

Step 38
Set [Print] to [on]

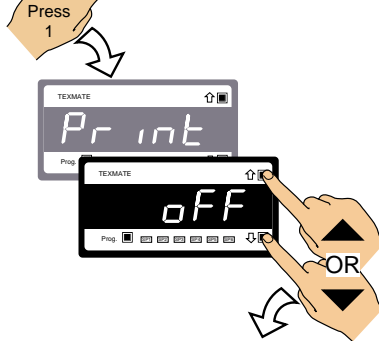

Step 39
Save the Print
Trigger setting

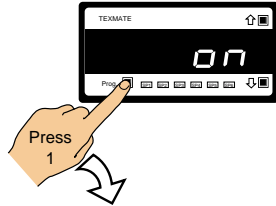

Step 40
Ensure [Log] is
set to [OFF]

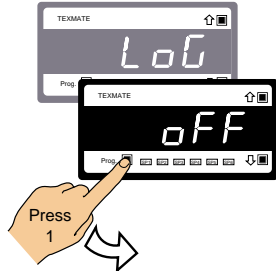

From Step 40

Step 41
Reset 3rd digit to 0. If the 3rd
digit is not reset to 0, the meter
constantly cycles thru SPC_6

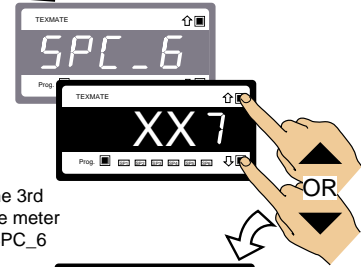

Step 42
Exit SPC_6 and return
to the Operational
Display

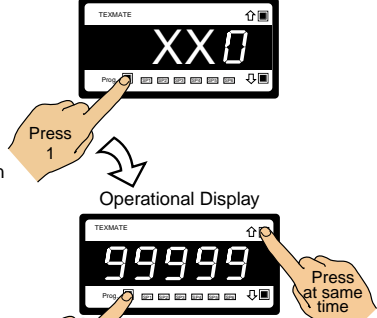

Step 43
Enter Brightness Mode



CONFIGURE CODE 3 TO ACTIVATE PRINT MODE

Step 44
Pass Brightness Mode,
Calibration Mode, Code 1,
Code 2, and enter Code 3

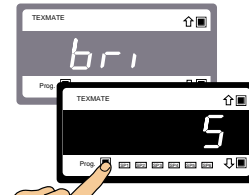

Step 45
Set Code 3 to [XX3]
1st Digit = X Not relevant to Print Mode
2nd Digit = X Not relevant to Print Mode
3rd Digit = 3 Activates Print Mode

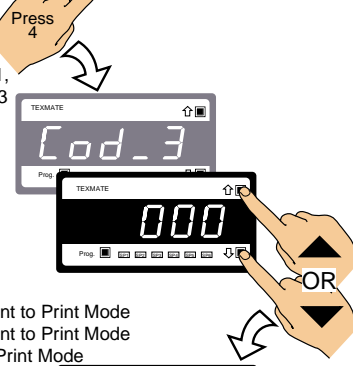

Step 46
Save setting and
enter Code 4

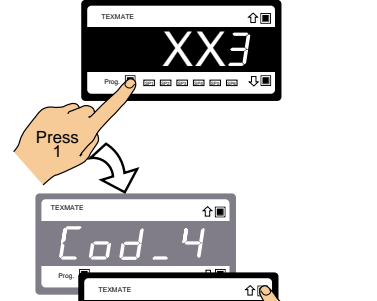

Step 47
Exit Code 4. Return
to Operational Display

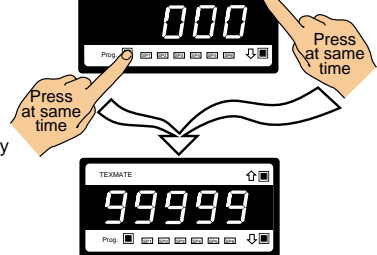

Operational Display

This Page intentionally left blank

Other Setpoint Related Functions

Data Logging & Data Printing from a Setpoint

Setpoints can be configured to trigger the following data logging and data printing functions:

- Data Logging from a Setpoint.
- Data Printing from Setpoint to a Serial Printer or PC.
- Setpoint Time Control and Logging.

Data Logging from a Setpoint

Any setpoint can be configured to log data within the meter (up to 4000 samples) for later download to a connected PC using a Terminal program.

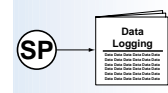

Data logging function settings are configured in Code 8.

More than 4000 samples (data records) can be stored (logged) in non-volatile memory for before and after analysis of any process condition. Up to 512 kilobits (64 kilobytes) of on-board memory is available for continuous loop recording.

Data logging can be triggered (activated) from a setpoint, the program button, or from an external switch. With a real-time clock installed, date and time stamps can be included.

See *Level 3 – Advanced Functions Mode*.

Data Printing from a Setpoint to a Serial Printer or PC

Any setpoint can be configured to send data directly from a meter register to a connected serial printer or PC.

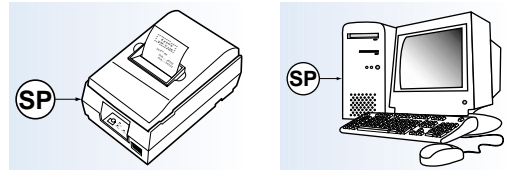

The **print mode** is a simple method of accessing data results stored in the meter. The print mode is primarily designed for applications that require a paper printout of data results printed directly to a serial printer. A powerful print string can be programmed to send descriptive text of 31 characters and data directly to a serial printer or PC.

Data results can be printed at regular time intervals in response to a button press on the meter, or when a setpoint is activated. When any of these pre-selected events occur, the meter transmits a user defined ASCII string of data from its serial port. The contents of the text string can contain date and time stamp information and can also include current register data from any register in the meter. The print string can be customized by setting the meter into the ASCII mode and writing to register X.

For further information on the print mode, see *Serial Communications Module Supplement (NZ202)*.

Setpoint Time Control and Logging

Any setpoint can be configured to operate from the real-time clock option for time control and logging applications.

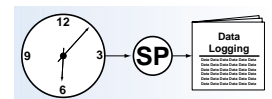

There are several methods of printing or logging data at set time intervals. These include using the setpoint timers, channel 3 & channel 4 interval timers, and using the real-time clock. The choice of which method is used depends on the time interval between triggers, and whether the time base needs to be synchronized with a real-time clock.

Not Synchronized to Real-time Clock

The following section describes different time control and logging methods that do not require synchronization with the optional real-time clock. Therefore, the meter does not require a real-time clock to be installed.

Note, for all following descriptions setpoint 1 (SP1) has been used unless otherwise stated.

Printing or Logging at Short Intervals

If the application requires data to be printed or logged at repeated intervals of less than 3 hours, 38 minutes and 27 seconds (or 13,107 seconds), this can be achieved using the setpoint timer functions (the real-time clock option is not required). To configure the meter for this application:

- 1) For continuous operation, set SP1 activation value so that SP1 is always activated. Or, set SP1 activation value to a specific value to start set interval logging / printing when the input signal reaches a certain value.
- 2) Configure setpoint timer functions so that SP1 operates in the **repeat** mode.
 - Set [SPC_1] to [XX6] with [rEPt] selected.
- 3) Set the **off-time** [oFF_t] and **on-time** [on_t] values so that the sum of these equals your required time interval.
 - While in [SPC_1] [XX6], set [oFF_t] and [on_t] to the required time intervals.
- 4) Select the **make** (or break) edge for SP1 trigger functions.
 - Set [SPC_1] to [XX7] with [MAKE] selected.
- 5) Select **Print** or **LoG** triggered from SP1.
 - While in [SPC_1] [XX7] select [Print] or [LoG].

Printing or Logging Over Longer Intervals

If the application requires data to be printed or logged at repeated intervals of greater than 3 hours, 38 minutes and 27 seconds, this can be achieved using the timer functions in channel 3 and channel 4. If channel 3 or channel 4 are setup to operate in the timer mode, they count up or down at a rate of one count per second. However by changing the scale factor for each channel, they can be made to count up or down at virtually any rate you require.

For example, if you want them to count in minutes, you would enter a scale factor of 1/60 (1.66667e-2). If you want them to count in hours you would set the scale factor to 1/3600 (2.77777e-4). IS THERE A SIMPLE WAY TO SHOW THE SCALE FACTOR CALC?



Hint:

You cannot enter very small scale factors like these via the front panel of the meter, but you can do so by writing to the appropriate register via the serial port in the ASCII mode.

Once you have set up channel 3 or channel 4 in the timer mode to count at the required rate, continue to configure the meter as follows:

- 1) Set the activation value of SP1 for the interval time you require between the log / print samples.
- 2) Set the data source for SP1 to **channel 3** or **channel 4**.
 - Set [SPC_1] to [X1X] and when in [SourC] select [Ch3] or [Ch4].
- 3) Select the **make** edge for SP1 trigger functions.
 - Set [SPC_1] to [XX7] with [MAKE] selected.
- 4) Set SP1 reset destination to **channel 3** or **channel 4**.
 - After selecting [MAKE], set [dESt] to [Ch3] or [Ch4].
- 5) Select **Const** for the reset mode and set the reset constant to **zero**.
 - After selecting [Ch3] or [Ch4], set [ModE] to [ConSt] then set [rES_C] to [0].
- 6) Select **Print** or **Log** triggered from SP1.
 - After selecting [ConSt], select [Print] or [LoG].

When channel 3 or channel 4 counts up to the setpoint activation value, the setpoint triggers a print or log and then resets channel 3 or channel 4 back to zero.

Synchronized to Real-time Clock

If the application needs to print or log data at certain times of the day, week, month, or year, then a real-time clock module must be installed in the meter. Following are descriptions of some of the methods of data logging and printing using the real-time clock.

Printing Or Logging From Time Value Only

If the application needs to log / print data for the same range of time each day, then this can be done with channel 3 or channel 4 set up in the real-time clock mode. You can set channel 3 or channel 4 to display the real-time clock in either HRS:MIN:SEC or HRS:MIN.

To take one print or log sample at a certain time of the day, set the setpoint activation value to the time required and set the setpoint trigger edge to make [MAKE].

More realistically, you might want to take periodic samples over a set range of time during the day or night. For instance, you might want to print or log data every half-hour from **5:30 pm to 8 am** the next morning. You can set this up as follows:

- 1) Set channel 3 or channel 4 to the **HRS:MIN** real-time clock mode.
 - For channel 3 set Code 5 to [X41].
 - For channel 4 set Code 6 to [X41].
- 2) Set the activation value for SP1 to the mid-point of the time range. The mid-point between 5:30 pm to 8 am is **12:45** am.
 - Set [SP_1] to [1245]. In the HRS:MIN real-time clock mode 1245 displays as 12:45.
- 3) Set the source of SP1 to channel 3 or channel 4 and select the **deviation** mode for SP1.
 - Set [SPC_1] to [X1X] and select [Ch3] or [Ch4].
 - Set [SPC_1] to [XX5] and select [dEVtn].
- 4) Set the deviation band to **4 hours, 45 minutes** (4:45).
 - While in [SPC_1] [XX5], set [PASSb] to [445].
- 5) Set the timer functions for SP1 to **repeat** mode and set the on-time and off-time to **15 minutes** (900.0 seconds).
 - Set [SPC_1] to [XX6] and select [tiMr] [rEPt].
 - Set [oFF_t] to [900.0] and [on_t] to [900.0].
- 6) Select the **make** (or break) edge and select **Print** or Log triggered from SP1.
 - Set [SPC_1] to [XX7] and set [triG] to [MAKE] the set [Print] or [LoG] to [on].
- 7) Set the 1st digit of the setpoint control settings to 1 so that SP1 is activated **outside** the deviation band.
 - Set [SPC_1] to [1XX].

Printing Or Logging Directly from the Real-time Clock

If similar functionality is required to the **Printing or Logging from Time Value Only** application above, but channel 3 and channel 4 are already being used for another input function, you can achieve a similar result by using the real-time clock registers directly. For the example in the **Printing or Logging from Time Value Only** application you would set the setpoint source to register number [215] (which is the real-time clock register for hours) instead of [Ch3] (as in **Printing or Logging from Time Value Only** above).

The only drawback with this approach is that you have less resolution so you would have to work to the nearest hour and your deviation band will always be an even number. This means that to cover the required time span you would have to log from 5 pm till 8 am the next morning. To set the meter up for this application:

- 1) Set the activation value for SP1 to the mid-point of the time range. The mid-point between 5:00 pm to 8 am is **12:30** am.
 - Set [SP_1] to [1230]. In the HRS:MIN real-time clock mode 1230 displays as 12:30.
- 2) Set the source for SP1 to register number 215 and select the **deviation** mode for SP1.
 - Set [SPC_1] to [X1X] and select [215].
 - Set [SPC_1] to [XX5] and select [dEVtn].

- 3) Set the deviation band to **4 hours** (4:00).
 - While in [SPC_1] [XX5], set [PASSb] to [445].
- 4) Set the timer functions for SP1 to **repeat** mode and set the on-time and off-time to **15 minutes** (900.0 seconds).
 - Set [SPC_1] to [XX6] and select [tiMr] [rEPt].
 - Set [oFF_t] to [900.0] and [on_t] to [900.0].
- 5) Select the **make** (or break) edge and select **Print** or Log triggered from SP1.
 - Set [SPC_1] to [XX7] and set [triG] to [MAKE]. Set [Print] or [LoG] to [on].
- 6) Set the 1st digit of the SP1 control settings to 1 so that the setpoint is activated **outside** the deviation band.
 - Set [SPC_1] to [1XX].

Printing or Logging From Calendar Registers

If the application needs to log / print once a week or once a month, then access the real-time clock registers directly. The following registers can all be used for this purpose:

- 213 = seconds (0 to 59)
- 214 = minutes (0 to 59)
- 215 = hours (0 to 23)
- 216 = days (1 to 7: 1 = Sunday, 7 = Saturday)
- 217 = date (1 to 31)
- 218 = month (1 to 12: 1 = January, 12 = December)
- 219 = year (0 to 99)

To configure an application to log / print every Friday at 5:00 pm requires two setpoints. In the following example use SP1 and SP2 and set the meter up as follows:

Setpoint Activation Value Mode

- 1) Set the activation value for SP1 to 6 (6 selects Friday as the day of the week).
 - Set [SP_1] to [6].
- 2) Set the setpoint activation value for SP2 to 18 (18 selects 6 pm as the hour of the day).
 - Set [SP_2] to [18].

Setpoint & Relay Control Settings Mode

Setpoint 1

- 3) Set the data source for SP1 to register # 216 (this is the days of the week reg.).
 - Set [SPC_1] to [X1X] and select register # [216].
- 4) Set the reset destination for SP1 to Result.
 - Set [SPC_1] to [XX7] and set [dESt] to [rESLt].
- 5) Select [rEG] for the reset mode and set the reset source to reg # 215 (hours).
 - While still in [XX7], set [ModE] to [rEG] and [SourC] to reg. [215].

Setpoint 2

- 6) Set the data source for SP2 to Result.
 - Set [SPC_2] to [X1X] and select [rESLt].
- 7) Select deviation mode for SP2 and set the deviation band to 1 (hour).
 - Set [SPC_2] to [XX5] and select [dEVtn].
 - While in [SPC_2] [XX5], set [PASSb] to [1].5
- 8) Select the **make** (or break) edge and select **Print** or Log triggered from SP2.
 - Set [SPC_2] to [XX7] and set [triG] to [MAKE] then set [Print] to [on].
- 9) Set the 1st digit of the SP2 control setting to 1 so that SP2 is activated **outside** the deviation band.
 - Set [SPC_2] to [1XX].



1934 Kellogg Ave., Carlsbad, CA 92008



Tel: (760) 598-9899



Fax: (760) 598-9828



URL: <http://www.texmate.com>

For ordering info call:1-800-TEXMATE (1-800-839-6283)

For tech assistance call:(760) 598-9899