



0.56" LEDs



LEOPARD FAMILY



Specifications

Input Specs: Depends on Input signal conditioner
A/D Converter: 14 bit single slope
Accuracy: ±(0.05% of reading + 2 counts)
Temp. Coeff.: 100 ppm/°C (Typical)
Warm up time: 2 minutes
Conversion Rate: 10 conversions per second (Typical)
Digital Display: **4 digit 0.56" LED red (std)**, green (optn)
 Range -1999 to 9999 counts.
Bargraph Display: **101 segment 235° circular red (standard)**,
 Green (optional) or tricolor (optional) LED.
Polarity: Assumed positive. Displays - negative
Decimal Selection: Front panel button selectable, X·X·X·X·
Positive Overrange: Bargraph and top segments of digital display
 flash.
Negative Overrange: First segment of bargraph and bottom seg-
 ments of digital display flash.
Relay Output: Two 9 Amp Form C relays, two 4 Amp Form
 A relays or 4 x 4 Amp Form A relays
Analog Output: Isolated 16 bit user scalable mA or V
 OIC (mA out) 4-20 mA @ 0 to 500Ω max loop resistance
 OIV (volts out) 0-10 V DC @ 500 Ω or higher resistance
Power Supply: AC/DC Auto sensing wide range supply
PS1 (std) 85-265 VAC / 95-300 VDC, 50-400Hz 4.2W
PS2 18-48 VAC / 10-72 VDC, 50-400Hz 4.2W
Operating Temp.: 0 to 50°C
Storage Temp.: -20°C to 70°C
Relative Humidity: 95% (non condensing)
Case Dimensions: Bezel (4.48"x4.48") 113.8x113.8mm
 Depth behind bezel (4.23") 107.46 mm
 Plus (0.48") 12.24 mm for connectors
Weight: 16 oz., 1lb 4 oz when packed

CL-B101D40

Smart 101 segment, 4 digit LED Tricolor or Mono-color digital bargraph controller with four fully programmable set points in a switchboard style case for monitoring, measurement, and control applications.

General Features

- External transmitters or signal conditioners can be eliminated by direct connection of the sensor output to more than 40 Plug-in Input Signal Conditioners that include:
 - AC/DC Current
 - AC/DC Voltage
 - Load Cell
 - Pressure
 - Process
 - Prototype
 - Resistance
 - Temperature
 - 4 to 20 mA
- Optional isolated 16 bit analog output. User or factory scalable to 4 to 20 mA, 0 to 20 mA or 0 to 10 V across any desired digital span from ± one count to the full scale range of - 1999 to 9999 (12000 counts).
- A Programmable Tricolor (Red-Green-Orange) or mono color (red or green), 101 segment high brightness bargraph.
- Red 4-digit LED display with a range of -1999 to 9999 (12000 counts). Optional green digital display.
- Front panel LED annunciators provide indication of setpoint status.
- Two 9 Amp Form C, and two 4 Amp Form A or 4 x 4 Amp Form A relays available.
- Auto-sensing AC/DC power supply. For voltages between 85-265 V AC / 95-300 V DC (PS1) or 18-48 V AC / 10-72 V DC (PS2).
- 24 V DC excitation is available to power external 4/20mA transmitters and 5 or 10 V DC excitation is available for resistance bridge type sensors.
- Provision to connect an external programming lockout switch.
- Provision for external DIM switch to reduce the brightest display setting by 50%.
- Automatic intelligent averaging, smooths noisy signals while providing a fast display response to real level changes.

Software Features

- The bargraph can display, full scale, any desired portion of the digital reading.
- Setpoint 1 has delay-on-make and delay-on-break plus a special "pump on pump off" mode that creates a Hysteresis Band between SP1 and SP2.
- Four programmable setpoints with adjustable Hysteresis.
- Bargraph center zero function.
- Relay activation can be selected to occur above (hi) or below (Lo) each setpoint.
- Digital display blanking.
- Decimal point setting.
- Four-level brightness control

Table of Contents

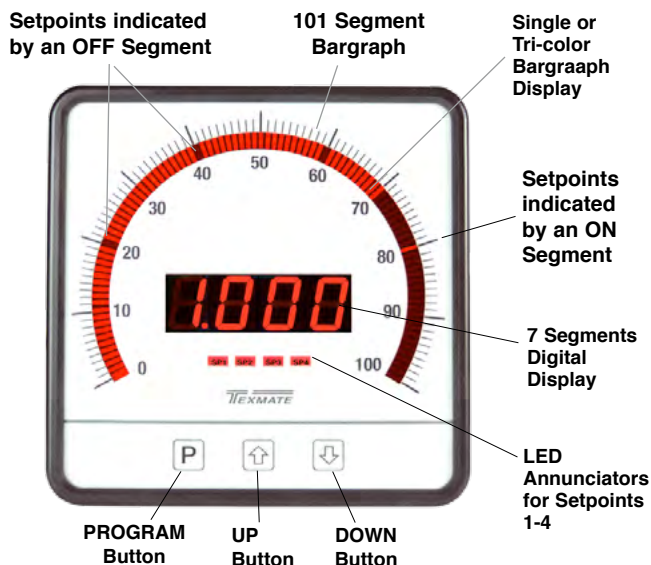

Bargraph Center Point Display Mode Selection . . .	6	Digital Span Selection for Display	5	Pin Descriptions	10
Bargraph Color Programming Mode	9	Digital Span Selection for Analog Range Output . . .	6	Programming Conventions	2
Case Dimensions	7	Functional Diagram	10	Setpoint Setting & Relay Configuration Mode	8-9
Component Layout	11	General Features	1	Software Features	1
Connector Pinouts	10	I-Series Input Signal Conditioning Modules . . .	12-14	Software Logic Tree	3
Connectors	11	Input Module Calibration Procedures	16	Specifications	1
Controls and Indicators	2	Input Module Component Glossary	15	Two Point Analog Range Setting & Calibration	7
Decimal Point and Brightness Selection	5	Installation guidelines	17	Two Point Digital Calibration Mode	4
		Ordering Information	18		

Front Panel Controls and Indicators





Front Panel Buttons

Program Button

The  button is used to move from one program step to the next. When pressed at the same time as the  button, it initiates the **calibration mode**. When pressed at the same time as the  button, it initiates the **setpoint setting mode**.

Up Button

When in the operational display, pressing the  button allows you to view the setting of the saved **Peak and Valley Values**.

When setting a displayed parameter during programming, the  button is used to increase the value of the displayed parameter.

Down Button

When in the operational display, pressing the  button allows you to change the **Brightness Level** as well as to view the setting of the setpoints **SP1, SP2, SP3 & SP4**.

When setting a displayed parameter during programming, the  button is used to decrease the value of the displayed parameter.

Front Panel LED Display

Annunciator LEDs

The annunciator LEDs indicate the alarm status. They are labeled from bottom to top: SP1, SP2, SP3, SP4.

Digital LED Displays

The digital LED displays are used to display the meter input signal readings. They also display the programming settings during programming.

Setpoint Indication

The position of setpoints on the bargraph display are indicated by an ON or OFF segment dependent on the bargraph display being above or below the setpoint.

Programming Conventions

To explain software programming procedures, logic diagrams are used to visually assist in following the programming steps. The following symbols are used throughout the logic diagrams to represent the buttons and indicators on the meter:



This symbol represents the OPERATIONAL DISPLAY.



This is the PROGRAM button.



This is the UP button.



This is the DOWN button.

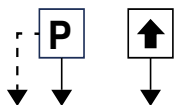

When a button is shown, press and release it to go onto the next step in the direction indicated by the arrow. When an alternative dotted line is shown, this indicates that an alternative logic branch will be followed when a particular option is present.

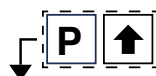





When two buttons are shown side by side and enclosed by a dotted line, they must be pressed at the same time then released to go onto the next programming step.

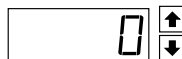





If an X appears through a digit, it means that any number displayed in that digit is not relevant to the function being explained.



When the  and  buttons are shown together, the display value can be increased by pressing and releasing the  button or decreased by pressing and releasing the  button.



When the  and  buttons are shown with two displays, either display can be selected by pressing and releasing the  or  buttons.

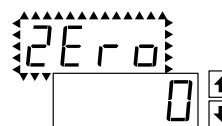



When two displays are shown together with bursts, this indicates that the display is toggling (flashing) between the name of the function and the value.

[Span]
[10000]

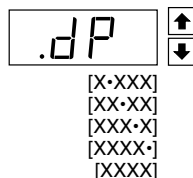
Text or numbers shown between square brackets in a procedure indicate the programming code name of the function or the value displayed on the meter display.



When there are more than two display selections they are shown in brackets below the first display and are also selectable by pressing and releasing the  or  buttons.

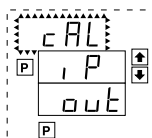

A dotted line enclosing an entire logic diagram indicates that programming branch will appear only when a particular option is present.

Software Logic Tree

The CL-B101D40 is an intelligent bargraph meter with a hierarchical software structure designed for easy programming and operation, as shown below in the software logic tree.

Software Version is Displayed on Power-up

When power is applied, all segments of the bargraph and digital display light up for 3 seconds. The version number of the installed software is then displayed for 2 seconds, after which, the operational display indicates the input signal.

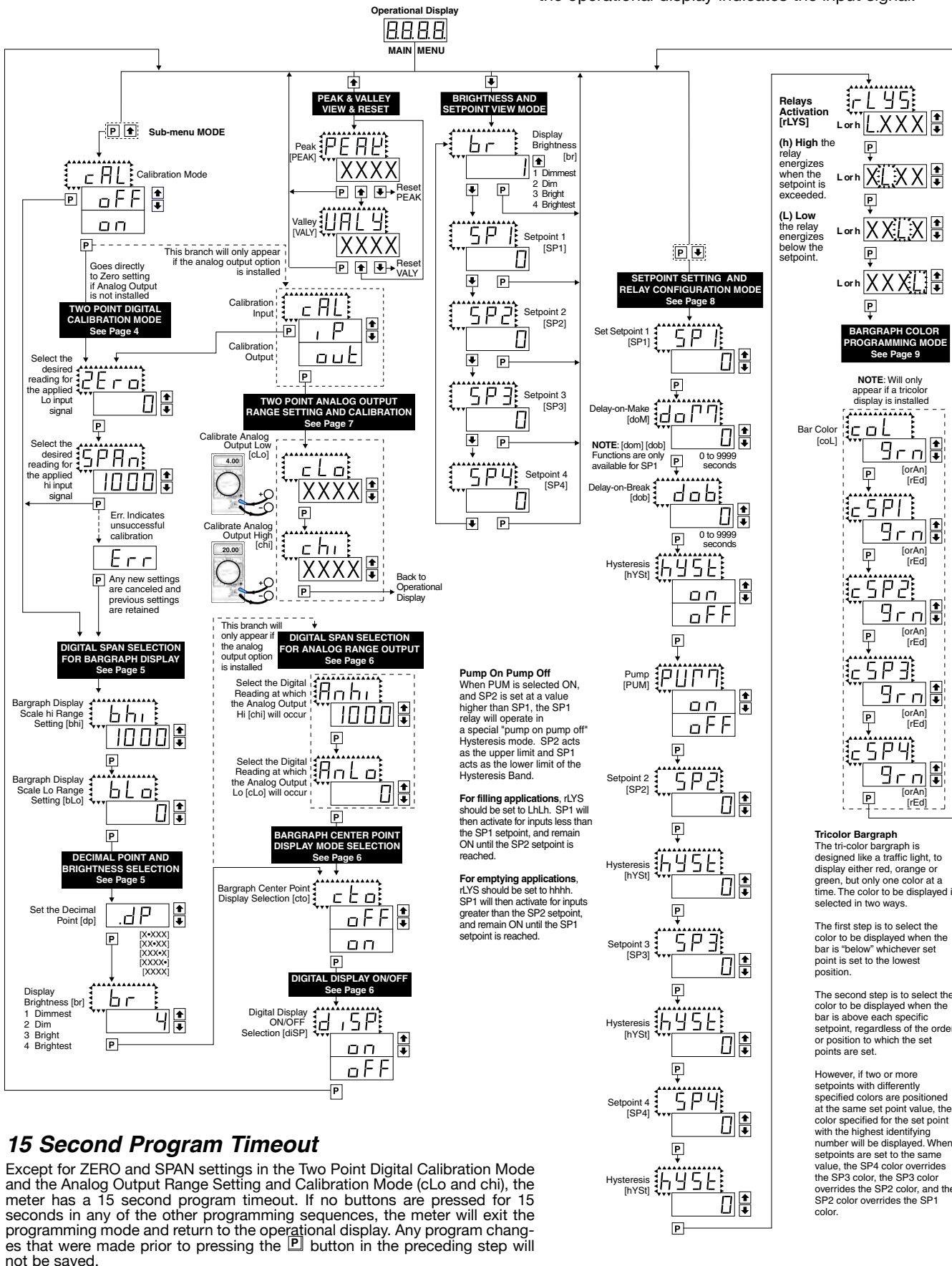

Two Point Digital Calibration Mode

This mode enables the meter to be calibrated by applying a zero or low input signal, entering the desired reading for that signal, then applying a high input signal, and then entering the desired reading for that signal. The meter then automatically calculates and programs in the requisite scale factor, within the following parameters.

1. Positive and negative signals may be applied, but the difference between the low and the high signal inputs must be at least 1000 counts or Err will be indicated.
2. Positive and Negative values for the desired reading can be entered, but the scale factor created can not exceed the Digital Display Span capability of the meter which is 12,000 counts between -1999 to 9999.
3. The internal Signal Span is limited to 3 V DC between -1 V DC to +2 V DC. Any outputs from an Input Signal Conditioning module that exceed these limits will cause the meter to indicate overrange regardless of the Digital Display Span scaled.

Note: Many input signal conditioners have provisions for analog calibration and scaling. If the meter is digitally set to read zero with a zero input (shorted input), and to read 1000 with a 1.000 V input, any pre-calibrated analog signal conditioner, with an output that does not exceed -1 V to +2 V, will read correctly without any further calibration when it is inserted in the meter.

STEP A Enter the Calibration Mode

- 1) Press the **P** and **↕** buttons at the same time. Display toggles between [CAL] and [oFF].
- 2) Press the **↕** or **↴** button. Display changes from [oFF] to [on].
- 3) Press the **P** button. Display toggles between [CAL] and [out].

Note: If at this point, the display skips directly to STEP C and toggles between [SPAN] and the previous [SPan] setting, the software is detecting that the optional analog output hardware is NOT installed.

STEP B Select Two Point Digital Calibration of Input Signal

- 1) Press the **↕** or **↴** button to select CAL [iP] for input signal calibration.
- 2) Press the **P** button. Display toggles between [ZEro] and the previous zero setting.

STEP C Set the Meter's Low Input Signal Reading on the Digital Display

- 1) Apply a zero or low signal to the meter. (Positive or negative values are allowed).
- 2) Using the **↕** and **↴** buttons, adjust the meter display to the desired reading for the applied low input signal.
- 3) Press the **P** button. Display toggles between [SPAN] and the previous span setting.

STEP D Set the Meter's High Input Signal Reading on the Digital Display

- 1) Apply a high input signal to the meter.
- 2) Using the **↕** and **↴** buttons, adjust the digital display to the desired reading for the applied high input signal.
- 3) Press the **P** button.

The Digital Calibration Procedure is now complete.

If the digital calibration was successfully completed, the menu branches to the Digital Span Selection for Bargraph Display (see page 5), and the display flashes [bhi] and the previous setting.

ERROR Indicates Unsuccessful Calibration

If the calibration was unsuccessful, the display indicates [Err], the new calibration settings just entered will not take effect and the previously stored setting will remain. The three most likely causes of an error during calibration are:

1. The full scale and zero signals were too similar. The full scale signal must be at least 1000 counts greater than the zero or low input signal (positive and negative values are allowed).
2. The scaling requirement exceeded the digital display span capability of the meter (12,000 counts between -1999 to 9999).
3. No input signal present, or incorrect input signal connections.

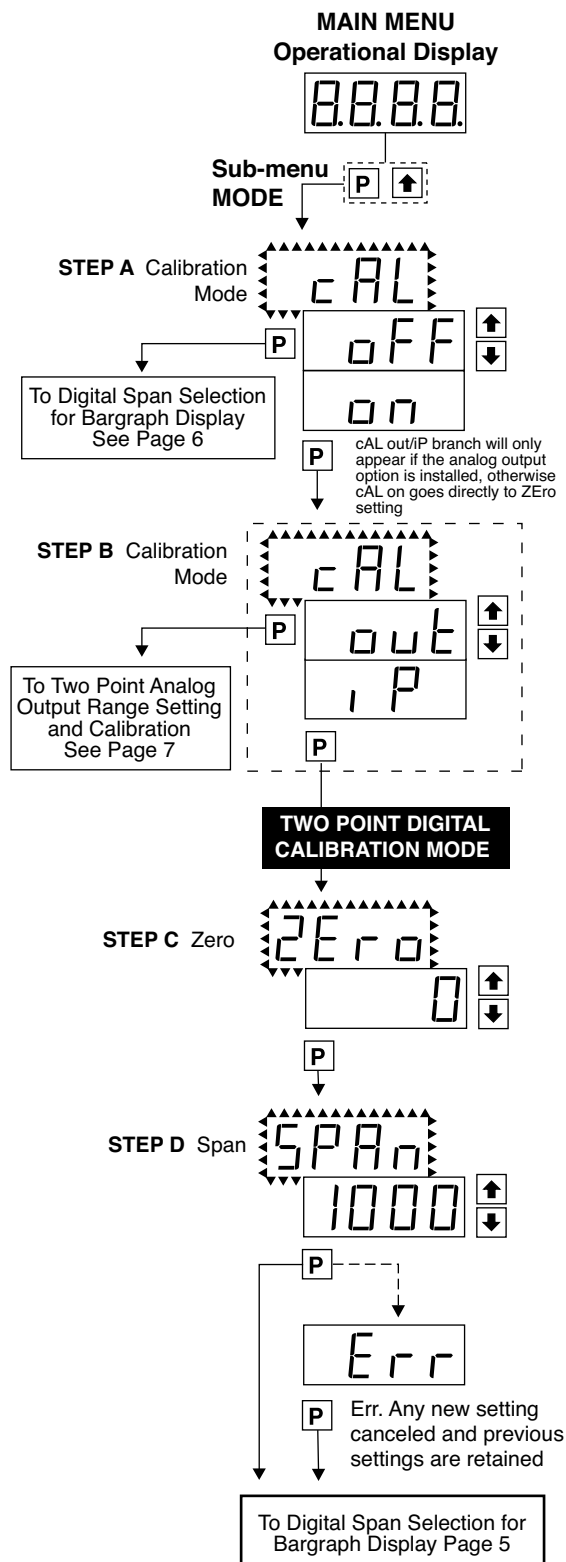

Digital Span Selection For Bargraph Display

The bargraph can be set to display full scale (0-101 bars) any portion of the digital reading from a minimum of 100 counts to a maximum of 12,000 counts. This provides higher resolution bargraph indication for those applications where the normal operating input signal range is less than the desired full scale display range of the digital display.

For Example:

If the full scale range of the meter has been set from -1999 to 9999 (0-12,000 counts), but the normal operating range of the input signal is between 4000 & 6000. The bargraph high parameter [bhi] can be set to 6000 and the bargraph low parameter [bLo] can be set to 4000.

This means that although the meter could digitally display a signal from -1999 to 9999 (0-12,000 counts), the bargraph display only begins to function at a reading of 4000, and reaches full scale indication at a reading of 6000. Although the digital display will continue reading up to 9999 before indicating overrange, the bargraph display will indicate its overrange by flashing for readings above 6000.

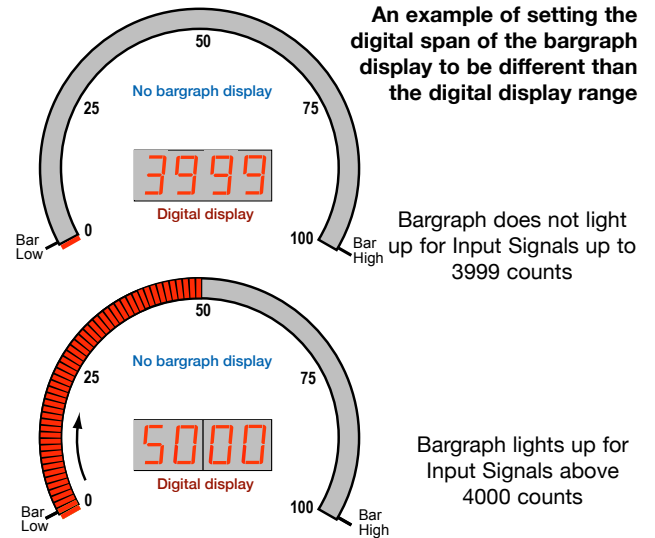

STEP A Enter the Calibration Sub Menu Mode

- 1) Press the **[P]** and **[↑]** buttons at the same time. Display toggles between [CAL] and [oFF].
- 2) Press the **[P]** button. Display toggles between [bhi] and the previous setting.

STEP B Set the Digital Span of the Bargraph Display (See example above)

- 1) Using the **[↑]** and **[↓]** buttons, adjust the display to the desired high parameter reading, e.g. 6000 counts.
- 2) Press the **[P]** button. Display toggles between [bLo] and the previous setting.
- 3) Using the **[↑]** and **[↓]** buttons, adjust the display to the desired low parameter reading, e.g. 4000 counts.
- 4) Press the **[P]** button. Display changes from [4000] to [dP].

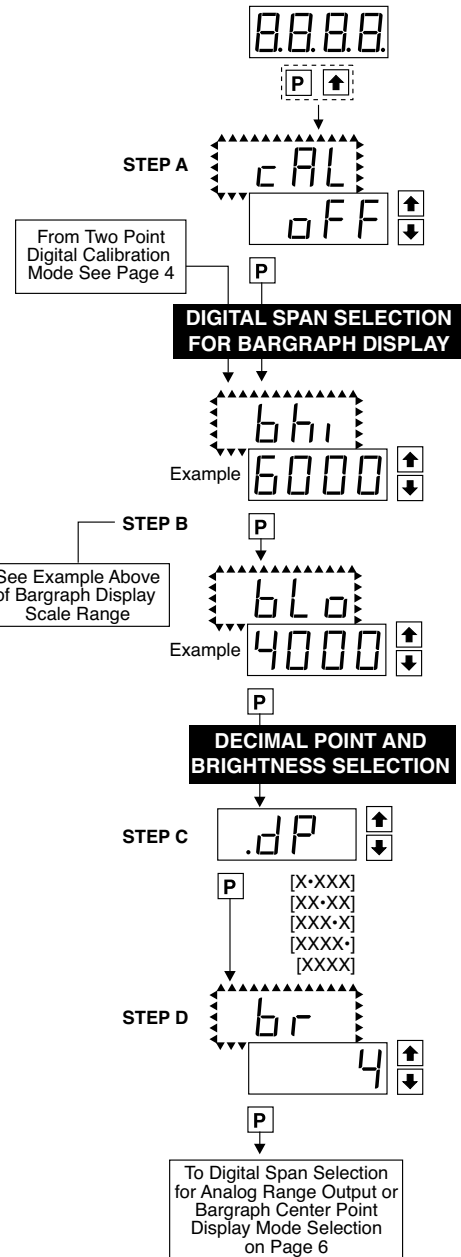

Decimal Point and Brightness Selection

STEP C Set the Decimal Point

- 1) Using the **[↑]** and **[↓]** buttons, adjust the display to the desired decimal point setting.
- 2) Press the **[P]** button. Display toggles between [br] and the previous brightness setting.

STEP D Set the Bargraph and Digital Display Brightness

- 1) Using the **[↑]** and **[↓]** buttons, adjust the display to the desired brightness setting (4 is the brightest setting).
- 2) Press the **[P]** button. Display toggles between [Anhi] and the previous [Anhi] setting.

Note: If at this point, the display skips directly to STEP G and toggles between [Cto] and [oFF], the software is detecting that the optional analog output hardware is NOT installed.

Digital Span Selection for Analog Range Output

STEP E Selecting the [AnHi] Digital Value for Analog High Output

- Using the \uparrow and \downarrow buttons, adjust the display to the desired digital value at which the [chi] Calibrated Analog High output will occur. For digital readings outside the digital span selected, the analog output will linearly rise above the value set for chi, up to the maximum analog output capability. However, the analog output will not go lower than the calibrated value set for cLo (see below).
- Press the P button. Display toggles between [AnLo] and previous [AnLo] setting.

STEP F Selecting the [AnLo] Digital Value for Analog Low Output

- Using the \uparrow and \downarrow buttons, adjust the display to the desired digital value at which the [cLo] Calibrated Analog Low output will occur. For Digital readings outside the Digital Span selected, the analog output will not go lower than the calibrated value set for cLo.
- Press the P button. The display toggles between [cto] and [oFF].

Note: Any two digital span points from -1999 to 9999 can be selected. The digital values for [AnHi] analog high and [AnLo] analog low can be reversed to provide a 20 to 4mA output. The digital span selected can be as small as two counts, when using the analog output to function as a Control or Alarm Driver. Small digital spans will cause the high resolution 16 bit D to A to increment digitally in stair case steps.

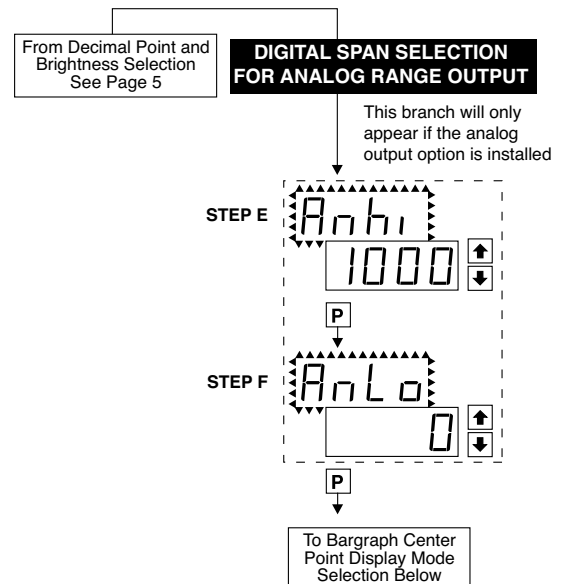

Bargraph Center Point Display Mode Selection

Example of Using the Center Point Bargraph Display Mode with a Unipolar Input

If the meter's full scale range is set to 5000 counts, the midpoint would be 2500 counts. If a signal of 2500 counts is applied only one segment at the 2500 count mark will light up. If a signal of 4000 counts is applied the segments between the center segment (2500 counts) and the 4000 count mark light up.

If a signal of 1000 counts is applied, the segments between the center segment (2500 counts) and the 1000 count mark will light up.

Example of Using the Center Point Bargraph Display Mode with Bipolar Signal Inputs

The meter may also be calibrated to display symmetrical bipolar signals such as ± 1 V or ± 10 V. When the center point display mode is selected, it will then function as a center zero meter. When positive signals are applied, the bar will go up from the center point, and when negative signals are applied, the bar will go down from the center point.

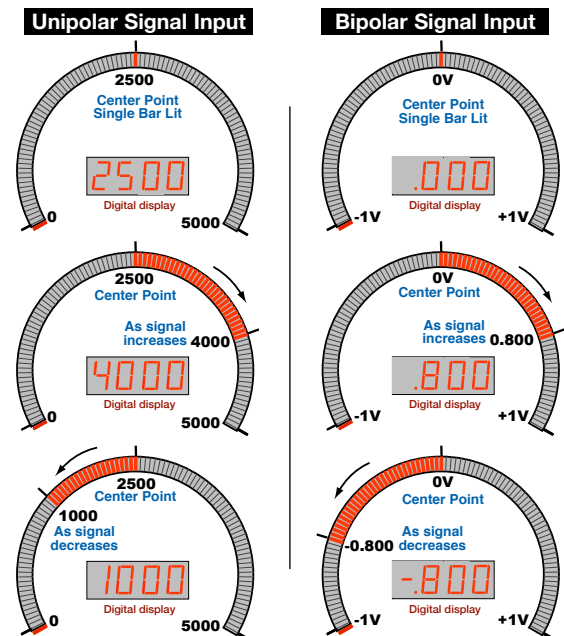

STEP G Bargraph Center Point Mode Selection (See example above)

- To select bargraph center point mode, press the \uparrow or \downarrow button. Display changes from [oFF] to [on].
- Press the P button. Display toggles between [diSP] and [on] or [oFF].

STEP H Digital Display ON/OFF Selection

- To set the display to [oFF], press the \uparrow or \downarrow button. Display toggles between [diSP] and [oFF].
- Press the P button. The display exits the calibration mode and returns to the operational display. Only the bargraph display is on and the digital display is off.

If the digital display is selected to be off, pressing any button to make programming changes or to view setpoints activates the digital display. When the procedure is complete, the digital display will then automatically switch off.

The Display/Bargraph settings are now complete.

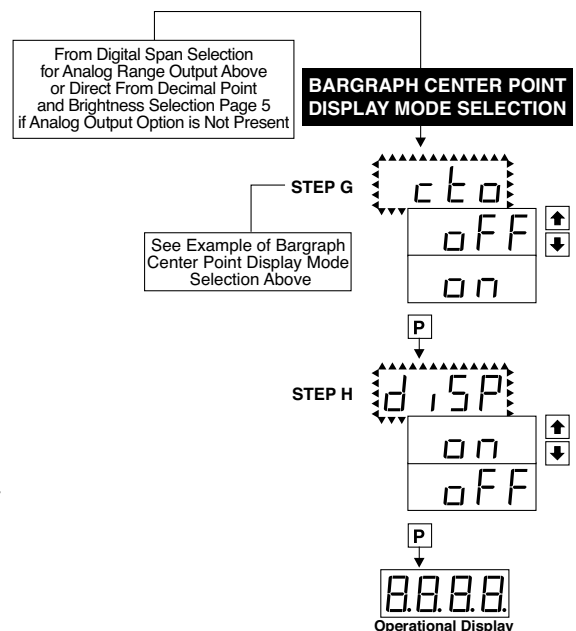

Two Point Analog Output Range Setting and Calibration

Determine if the Analog Output Selection Header is in the 4 to 20mA (0-20mA) position or the 0 to 10VDC position. If necessary, the module may have to be removed and the header position changed (see Component Layout below).

Note: Always disconnect power from the meter before removing the analog output module to adjust the mA or Volts output selection header and reinstalling it. When power is reconnected, the meter's software will automatically detect the presence or absence of the analog output module.

STEP A Enter the Calibration Mode

- 1) Press the **[P]** and **[↑]** buttons at the same time. Display toggles between [cAL] and [oFF].
- 2) Press the **[←]** or **[→]** button. Display changes from [oFF] to [on].
- 3) Press the **[P]** button. Display toggles between [cAL] and [out] input calibration.

Note: If at this point the display skips directly to toggle between Zero and the previous Zero setting, the software is detecting that the optional analog output hardware is NOT installed.

STEP B Enter the Two Point Analog [ouT] Output Range Setting and Calibration Mode

- 1) Press the **[P]** button. Display toggles between [cLo] and an internal scale factor.

STEP E Set or Calibrate [cLo] the Low Analog Value of the Analog Output Range

- 1) Connect a multimeter to analog output pins 17 and 18 (see Rear Panel Pinouts on page 10). Using the **[←]** and **[→]** buttons, adjust the analog output to the desired low value as measured on the multimeter. cLo may be adjusted to any value from -0.3 mA to 18 mA (mA output selected) or from -0.6 V to 8 V (volt output selected). However, the output of cLo must always be less than the value selected for chi. If a reversed analog output is desired, the values selected to establish the Digital Span can be reversed (see top of page 6). For digital readings outside the Digital Span selected, the analog output will not go any lower than the calibrated value set for cLo. However, the analog output will linearly rise above the value set for chi, up to the maximum analog output capability (see chi below).
- 2) Press the **[P]** button. Display toggles between [chi] and an internal scale factor.

STEP F Set or Calibrate [chi] the High Analog Value of the Analog Output Range

- 1) Using the **[←]** and **[→]** buttons, adjust the analog output to the desired high value as measured on the multimeter display. chi may be adjusted to any value from 18 mA to 24 mA (mA output) or from 8 V to 10.3 V (volt output). However, the value must be higher than the value selected for cLo. For digital readings outside the Digital Span selected, the analog output will linearly rise above the value set for chi, up to the maximum analog output capability.
- 2) Press the **[P]** button. The meter exits the calibration mode and returns to the operational display.

Note: The analog output range established by the values selected for cLo and chi will occur, automatically scaled, between the two digital values selected for AnHi and AnLo. However, the analog output can linearly rise above the chi value set for digital readings outside the digital span selected. See Digital Span Selection on page 6.

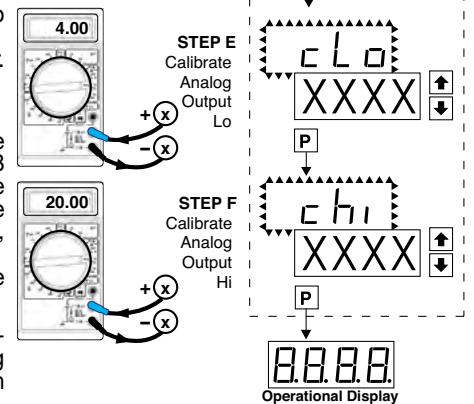
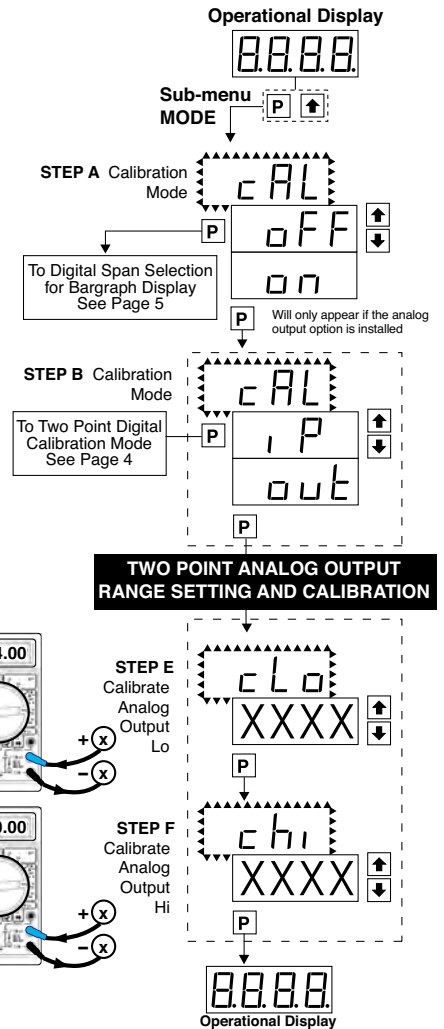

TWO POINT ANALOG OUTPUT RANGE SETTING AND CALIBRATION

Case Dimensions

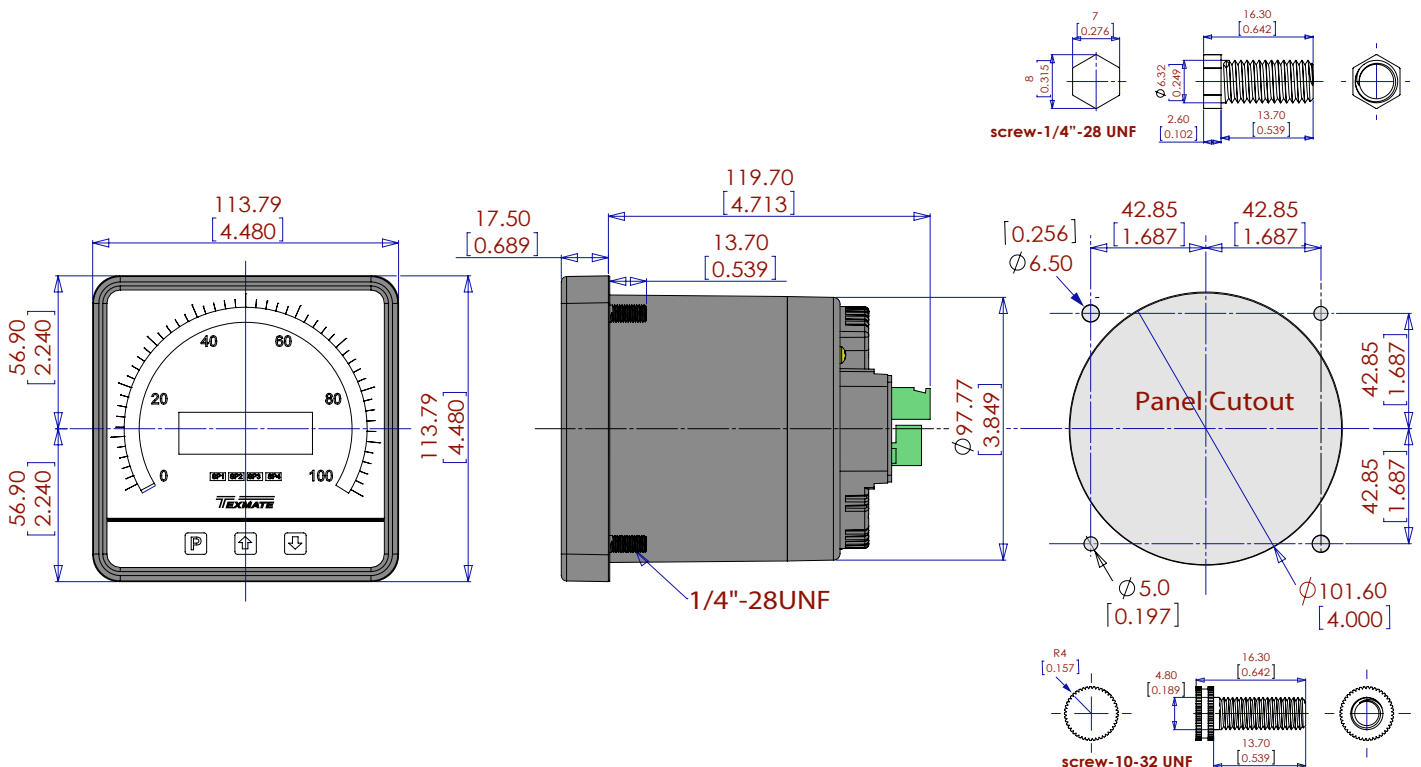

Setpoint Setting and Relay Configuration Mode

The following programming steps are required to enter the setpoint values and configure the relay functions in a meter with four relays using four setpoints. Generally if less than four relays are installed, the setpoints without relays are operational in software for tri-color control or display only purposes. To remove unwanted setpoint indications, set them to 9999 or -1999 depending on the relay activation mode selected.

STEP A Enter the Setpoint Mode

- 1) Press the **P** and **↓** buttons at the same time. Display toggles between [SP1] and the previous SP1 setting.

STEP B Set Setpoint 1 [SP1]

- 1) Using the **↑** and **↓** buttons, adjust the display to the desired SP1 value.
- 2) Press the **P** button. Display toggles between [doM] and the previous [doM] setting.

STEP C Set the SP1 Delay-on-Make [doM] Delay Time Setting

- 1) Using the **↑** and **↓** buttons, adjust the display to the desired [doM] value (0 to 9999 seconds). The reading must continuously remain in an alarm condition until this delay time has elapsed before the relay will make contact (energize).
- 2) Press the **P** button. Display toggles between [dob] and the previous [dob] setting.

STEP D Set the SP1 Delay-on-Break [dob] Delay Time Setting

- 1) Using the **↑** and **↓** buttons, adjust the display to the desired [dob] value (0 to 9999 seconds). The reading must continuously remain in a non-alarm condition until this delay time has elapsed before the relay will break contact (de-energize).
- 2) Press the **P** button. Display toggles between [hYSt] and the previous [hYSt] setting.

STEP E Select the Hysteresis [hYSt]

- 1) Using the **↑** and **↓** buttons, select the Hysteresis to be ON or OFF.
- 2) Press the **P** button. Display toggles between PUM and (on) or (oFF).

STEP F Select Pump [PUM] (on) or (oFF)

- 1) Using the **↑** and **↓** buttons, select the Pump to be ON or OFF. When PUM is selected ON, and SP2 is set at a value higher than SP1, the SP1 relay will operate in a special "pump on pump off" mode. SP2 acts as the upper limit and SP1 acts as the lower limit of the Hysteresis Band on the SP1 relay.

For filling applications:

[rLYS] should be set to [LhXX] (see step M). The SP1 relay and SP1 LED Annunciator will then activate for inputs less than the SP1 setpoint, and remain ON until the SP2 setpoint is reached.

For emptying applications:

[rLYS] should be set to [hhXX] (see step M). The SP1 relay and SP1 LED Annunciator will then activate for inputs greater than the SP2 setpoint, and remain ON until the SP1 setpoint is reached.

- 2) Press the **P** button. Display toggles between [SP2] and the previous SP2 setting.

STEP G Set Setpoint 2 (SP2)

- 1) Using the **↑** and **↓** buttons, adjust the display to the desired SP2 value.
- 2) Press the **P** button. Display toggles between [hySt] and the previous [hySt] setting.

STEP H Select the Hysteresis [hYSt]

- 1) Using the **↑** and **↓** buttons, select the Hysteresis to be ON or OFF.
- 2) Press the **P** button. Display toggles between [SP3] and the previous [SP3] setting.

STEP I Set Setpoint 3 (SP3) (No [doM] or [dob])

- 1) Using the **↑** and **↓** buttons, adjust the display to the desired SP3 value.
- 2) Press the **P** button. Display toggles between [hySt] and the previous [hySt] setting.

STEP J Select the Hysteresis [hYSt]

- 1) Using the **↑** and **↓** buttons, select the Hysteresis to be ON or OFF.
- 2) Press the **P** button. Display toggles between [SP4] and the previous [SP4] setting.

STEP K Set Setpoint 4 (SP4) (No [doM] or [dob])

- 1) Using the **↑** and **↓** buttons, adjust the display to the desired SP4 value.
- 2) Press the **P** button. Display toggles between [hySt] and the previous [hySt] setting.

STEP L Select the Hysteresis [hYSt]

- 1) Using the **↑** and **↓** buttons, select the Hysteresis to be ON or OFF.
- 2) Press the **P** button. Display toggles between [rLYS] and the previous relay setting.

Please Continue On Next Page.

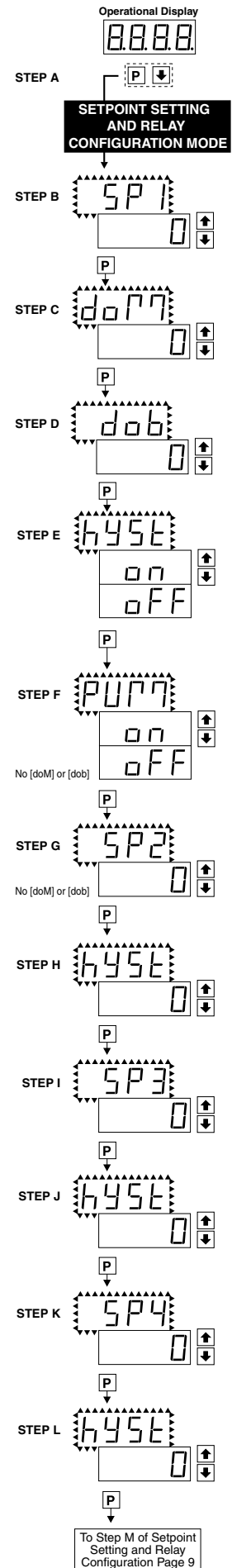

Setpoint Setting and Relay Configuration Mode Continued

STEP M Set Relay Activation mode [rLYS] for SP1

(h) High the relay energizes when the setpoint is exceeded. (L) Low the relay energizes below the setpoint. The setpoint is indicated from left to right SP1, SP2, SP3, SP4.

- Using the and buttons, select (L) or (h) for the first digit, which corresponds to SP1.
- Press the button. The SP2 Relay Activation digit begins to flash, and its decimal point is lit.

STEP N Set High (h) or Low (L) for SP2

- Using the and buttons, select (L) or (h) for the second digit, which corresponds to SP2.
- Press the button. The SP3 Relay Activation digit begins to flash, and its decimal point is lit.

STEP O Set High (h) or Low (L) for SP3

- Using the and buttons, select (L) or (h) for the third digit, which corresponds to SP3.
- Press the button. The SP4 Relay Activation digit begins to flash, and its decimal point is lit.

STEP P Set High (h) or Low (L) for SP4

- Using the and buttons, select (L) or (h) for the fourth digit, which corresponds to SP4.
- Press the button.

If a mono-color red or green display is installed then the Setpoint Relay Programming Mode is now complete and the meter returns to the operational display.

If a tricolor bargraph display is installed then the Bargraph Color Programming Mode will be entered and display toggles between [CoL] and the previous setting. Color selection menu will be displayed.

Bargraph Color Programming Mode

To comply with the latest safety requirements, the tri-color bargraph is designed like a traffic light, to display either red, orange or green, but only one color at a time. When the bar reaches a selected color change point, the entire bar will change to the color designated for that zone. This eliminates any ambiguity as to the signal status, especially just after transitioning to a new zone.

First (Step Q) is to select the color to be displayed, when the bar is “below*”, whichever set point is set to the lowest position.

Second (Steps R, S, T, and U) is to select the color to be displayed when the bar is above each specific set point, regardless of the order or position to which the set points are set.

However, if two or more setpoints with differently specified colors are positioned at the same set point value, the color specified for the set point with the highest identifying number will be displayed. When set points are set to the same value, the SP4 color overrides the SP3 color, the SP3 color overrides the SP2 color, and the SP2 color overrides the SP1 color.

STEP Q Select Bargraph Color when the bar is BELOW* the Setpoint that is set to the lowest position

- Using the and buttons, select the desired bargraph color [grn], [oran] or [red]
- Press the button. Display toggles between [CSP1] and the previous color setting.

STEP R Select Bargraph Color when the bar is ABOVE* SP1 Setpoint

- Using the and buttons, select the desired bargraph color [grn], [oran] or [red]
- Press the button. Display toggles between [CSP2] and the previous color setting.

STEP S Select Bargraph Color when the bar is ABOVE* SP2 Setpoint

- Using the and buttons, select the desired bargraph color [grn], [oran] or [red]
- Press the button. Display toggles between [CSP3] and the previous color setting.

STEP T Select Bargraph Color when the bar is ABOVE* SP3 Setpoint

- Using the and buttons, select the desired bargraph color [grn], [oran] or [red]
- Press the button. Display toggles between [CSP4] and the previous color setting.

STEP U Select Bargraph Color when the bar is ABOVE* SP4 Setpoint

- Using the and buttons, select the desired bargraph color [grn], [oran] or [red]
- Press the button. The meter exits the setpoint mode and returns to the operational display.

The Bargraph Color programming mode is now complete.

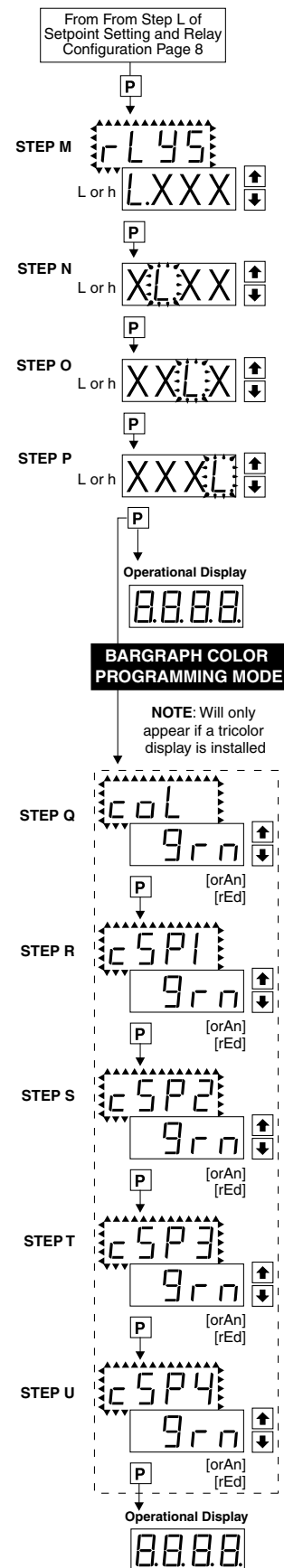

Functional Diagram

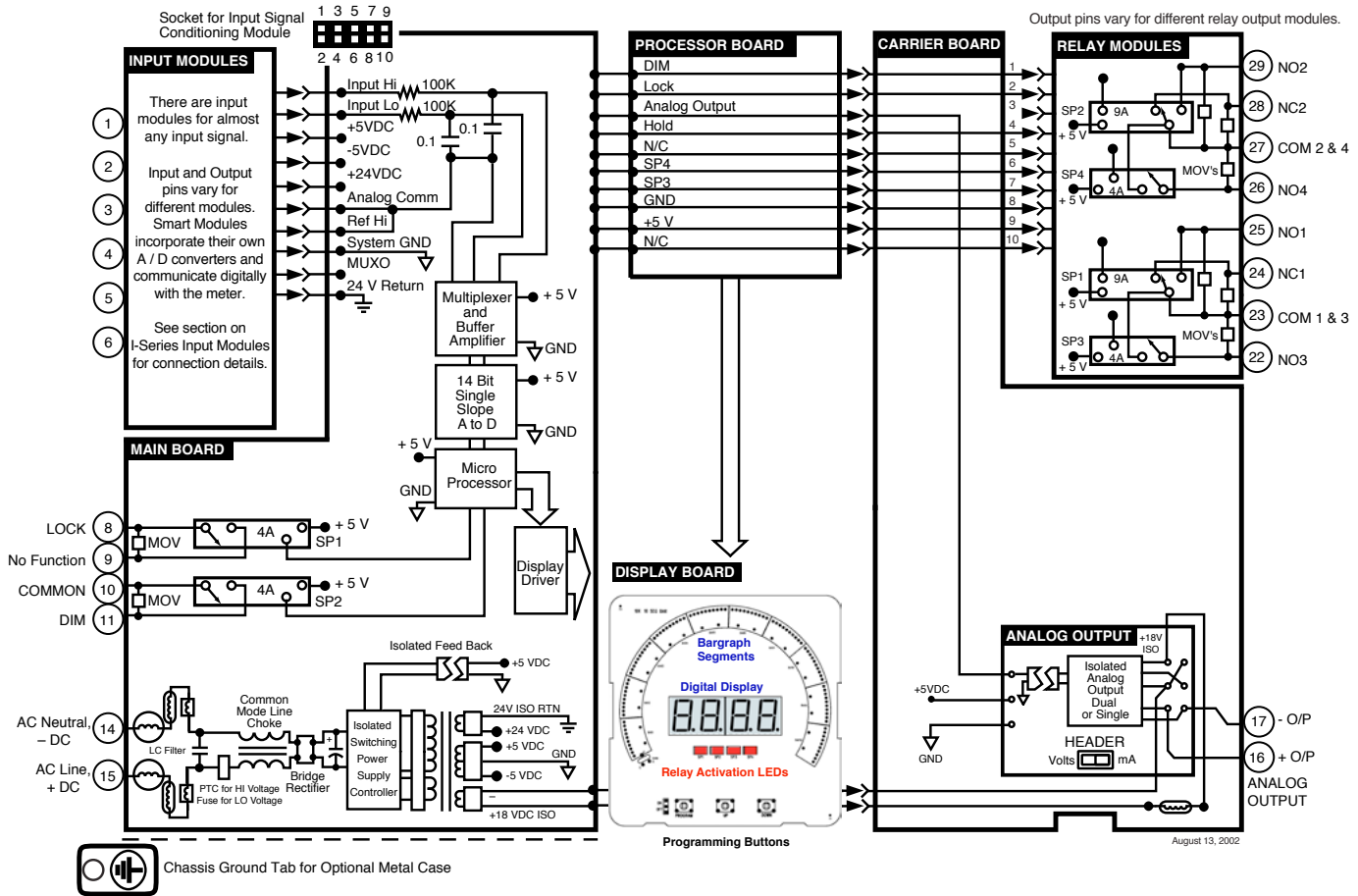

Connector Pinouts

Pinout Diagram

The Rear View of the Meter diagram shows the meter with the relay configuration: dual 9 Amp Form C and dual 4 Amp Form A relays. An analog output module is also shown as installed.

The CL-B101D40 uses plug-in type screw terminal connectors for all input and output connections. The power supply connections (pins 14 and 15) have a unique plug and socket outline to prevent cross connection. The main board and input signal conditioner use right-angled connectors as standard. The output module uses straight-thru connectors as standard.



WARNING: AC and DC input signals and power supply voltages can be hazardous. Do Not connect live wires to screw terminal plugs, and do not insert, remove or handle screw terminal plugs with live wires connected.

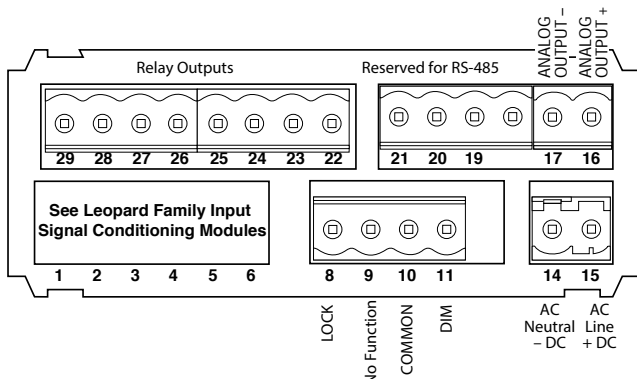

Auto-sensing AC/DC power supply. For voltages between 85-265 V AC / 95-300 V DC (PS1) or 18-48 V AC / 10-72 V DC (PS2).

Standard plug-in screw terminal connectors provided by Texmate:

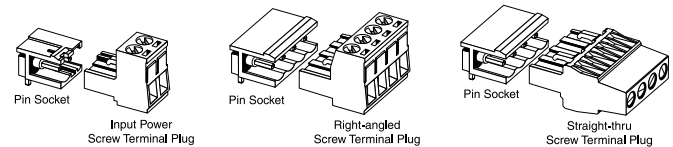

Input Signal – Pins 1 to 6

Pins 1 to 6 are reserved for the input signal conditioner. See the data sheet for the selected input signal conditioner.

Pins 8 to 11 – Rear Panel Function Pins

Pins 8 to 11 provide functions that can be implemented with an external switch. Their pin definitions are:

- Pin 11 DIM.** By connecting the display dim (DIM) pin to the COMMON pin, the display brightness setting is halved.
- Pin 10 COMMON.** To activate the LOCK or DIM functions from the rear of the meter, the respective pins have to be connected to the COMMON pin. This pin is connected to the internal power supply ground.
- Pin 9 No function**
- Pin 8 LOCK.** By connecting the LOCK pin to the COMMON pin, the meter's programmed parameters can be viewed but not changed.

Connector Pinouts continued

AC/DC Power Input- Pins 14 and 15

Auto-sensing AC/DC power supply. For voltages between 85-265 V AC/95-300 V DC (PS1) or 18-48 V AC/10-72 V DC (PS2).

Pin 14 AC/DC Neutral. Neutral power supply line.

Pin 15 AC/DC line. Live power supply line.

Optional Carrier Board Output Pins

Analog Output- Pins 16 and 17

Pins 16 and 17 are the analog output pins on the optional output module. Their pin definitions are:

Pin 16 Positive (+) analog output.

Pin 17 Negative (-) analog output.

RS-485 Output- Pins 19, 21 and 21

Pins 22 to 29 – Output Module Pins

Relay Modules with 4 Independent 300V (210mA DC only)

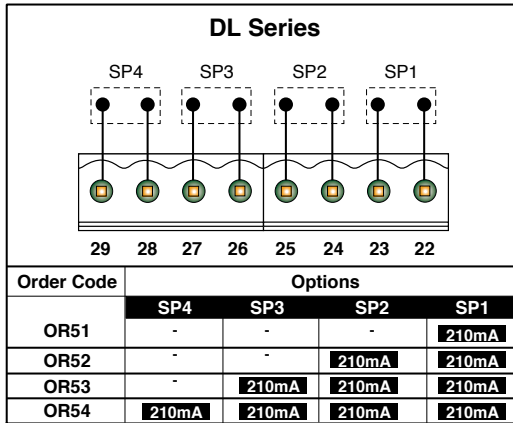

Relay Modules with 2 Non-Isolated 4A Form A Relays, and 2 Non-Isolated 9A Form C Relays

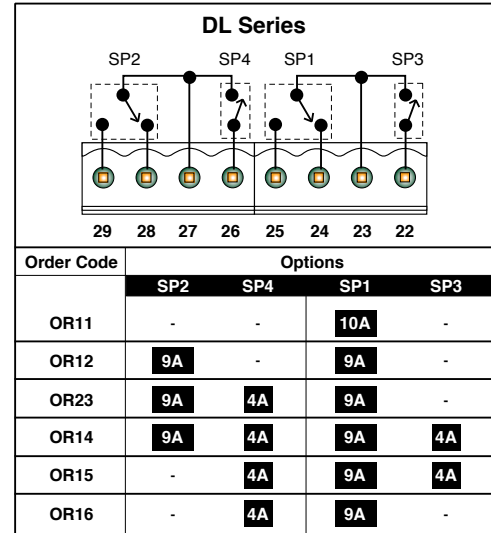

Relay Modules with 4 Isolated 5A Form A Relays

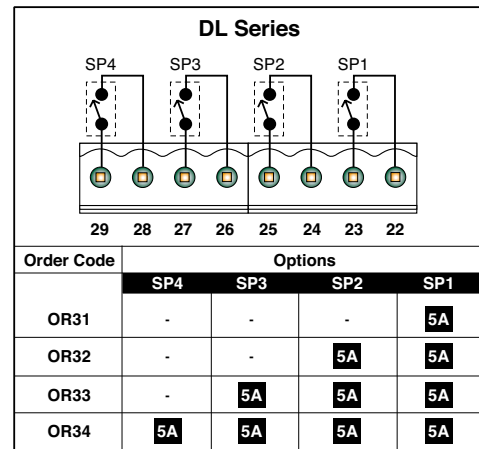



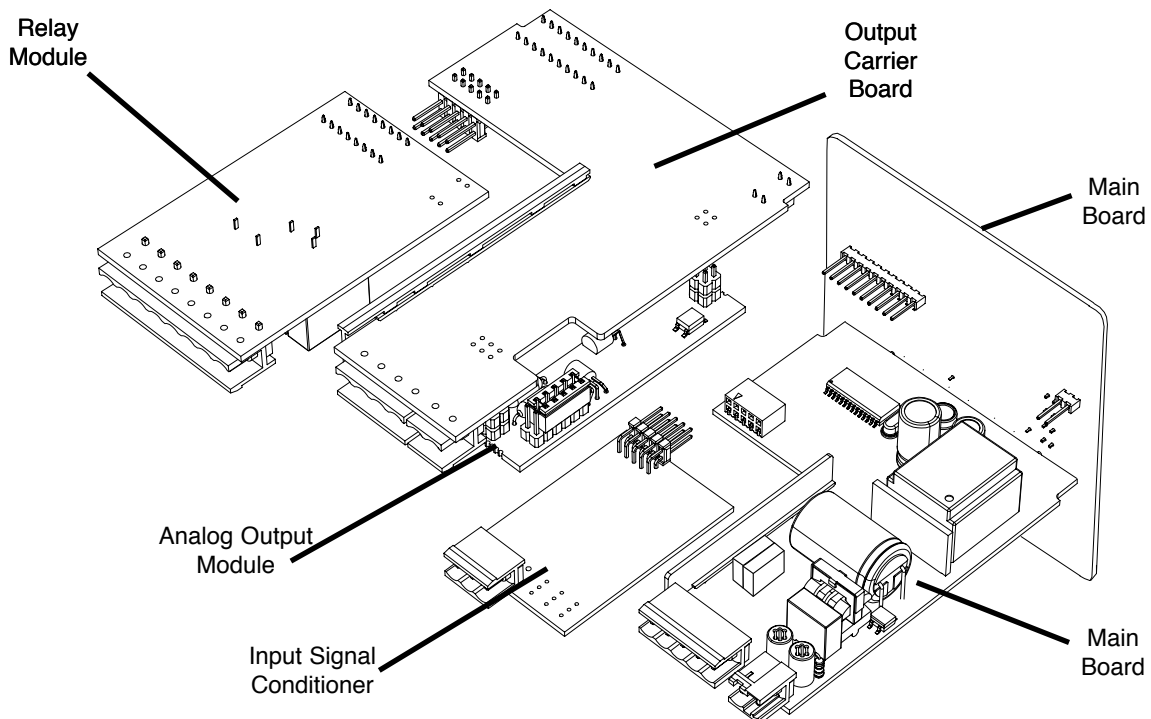





Component Layout



I-Series Input Signal Conditioning Modules

Many additional input modules are available and others are constantly being developed. Check with your local distributor or www.texmate.com for updated information.

Pre-calibrated **I-Series** input modules, that have span or zero potentiometers, can be interchanged between any **I-Series** compatible meter, without recalibration, because all of the analog scaling and reference circuitry is self-contained within the module. Where appropriate, all the standard ranges shown are designed to be header selectable by the user, and Texmate's unique SPAN ADJUST Header facilitates scaling to almost any required engineering unit. See Input Module Component Glossary and Calibration on pages 13 and 14. Also see Two Point Digital Calibration and Digital Calibration on page 4. Unless otherwise specified Texmate will ship all modules pre-calibrated with factory preselected ranges and/or scalings as shown in **BOLD** type. Other pre-calibrated standard ranges or custom ranges may be ordered. Factory installed custom scaling and other custom options are also available (see Ordering Information, Special Options on last page).

Symbols Indicate Module Compatibility Within Meter Families		
 TIGER Family	 TIGER Family	 TIGER Family
 LEOPARD Family	 LEOPARD Family	 LEOPARD Family
 LYNX Family	 LYNX Family	 LYNX Family
ALL MODELS	SOME MODELS	MODEL SPECIFIC



WARNING: AC and DC input signals and power supply voltages can be hazardous. Do Not insert, remove or handle modules with live wires connected to any terminal plugs.

IA01: AC Volts Scaled RMS, 200/300V AC

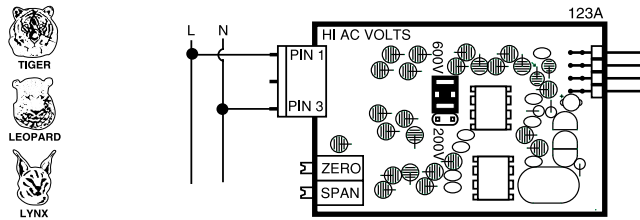

IA06: AC Volts True RMS, 300V AC

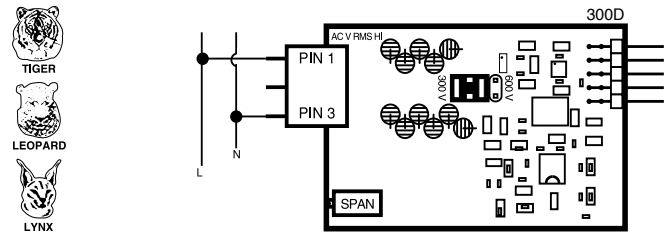

IA02: AC Volts Scaled RMS, 200mV/2V/20V AC

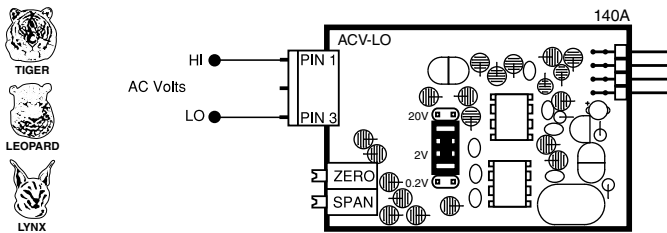

IA07: AC Volts True RMS, 200mV/2V/20V AC

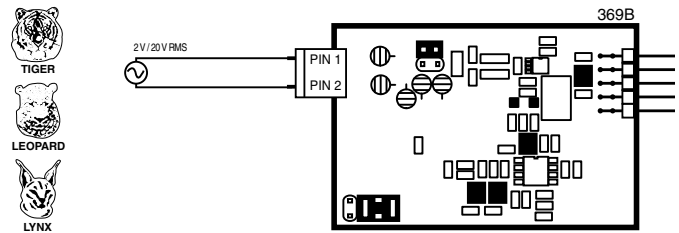

IA03: AC Milliamps Scaled RMS, 2/20/200mA AC

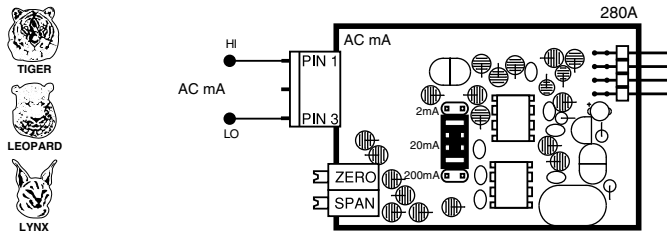

IA08: AC Milliamps True RMS, 2/20/200mA AC

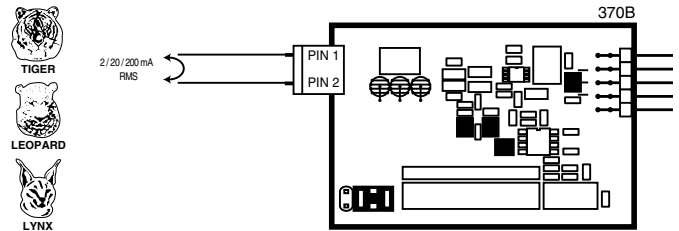

IA04: AC AC Amps Scaled RMS, 1 Amp AC

IA05: AC AC Amps Scaled RMS, 5 Amp AC

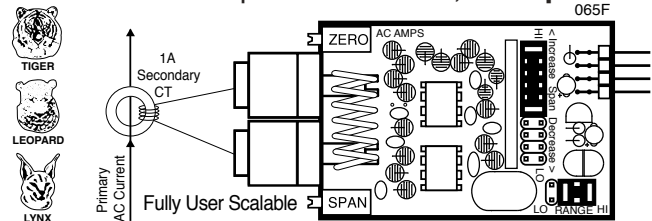

IA09: AC Amps True RMS, 1 Amp AC

IA11: AC Amps True RMS, 5 Amp AC

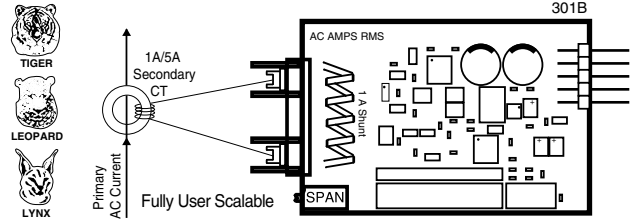

I-Series Input Signal Conditioning Modules

IA10: AC Millivolts, Scaled RMS, 100mV AC

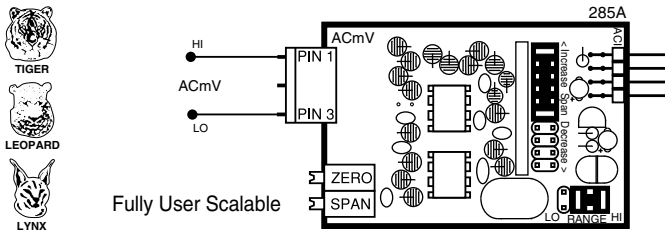

IA12: AC Millivolt RMS Sigma Delta

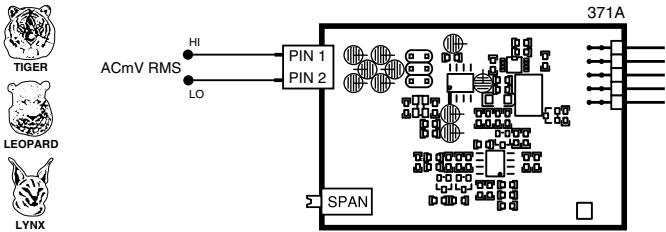

ID05: DC Volts 2/20/200/Custom V DC with Offset and 24V Exc.

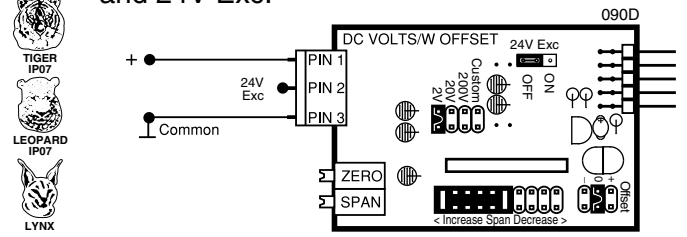

ID07: DC Milliamps, 2/20/200mA DC with Offset and 24V Exc

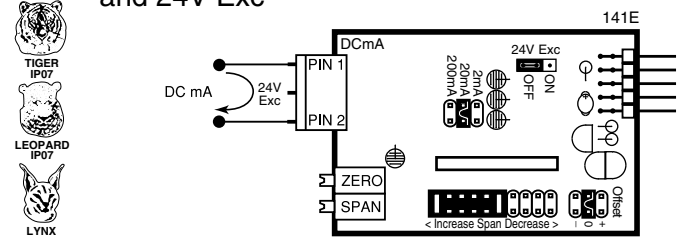

ID01: DC Volts, 2/20/200V/Custom w/24V DC Exc

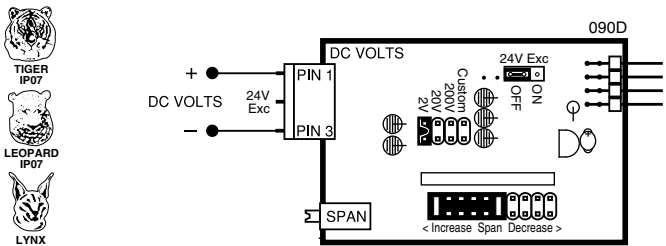

ID02: DC Millivolts, 20/50/100/200mV DC w/24V DC Exc

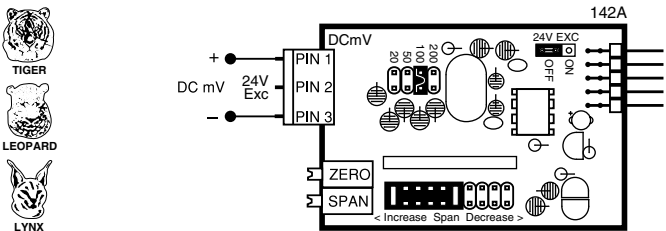

ID03: DC Milliamps, 2/20/200mA DC w/24V DC Exc

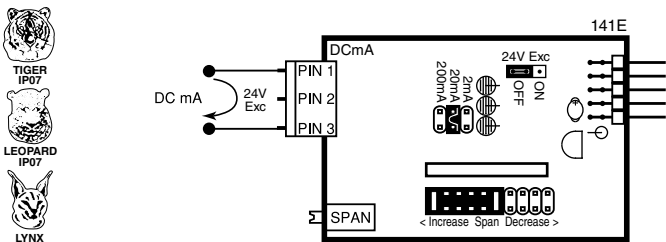

ID04: DC Amps, 5A DC

ID09: DC Amps, 1A DC

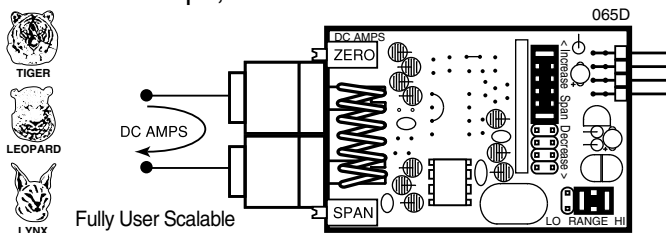

IGYZ: Universal Direct Pressure (Absolute or Differential/Gage)

See below for ordering code options

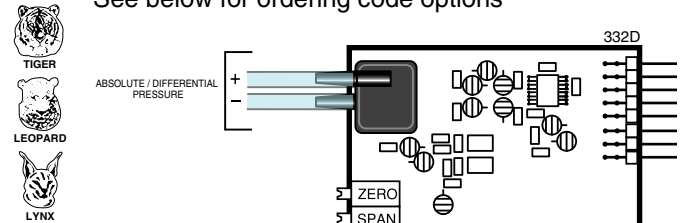

Direct Pressure (IGYX, IGYG & IGYZ) Ordering Code Options

I G → For Single Channel IGYX with two digital inputs, the last digit of order code is always X.

Sensor Range	CH1 Order Code	CH2 Order Code
1 psi Absolute	A	A
1 psi Differential	B	B
5 psi Absolute	C	C
5 psi Differential	D	D
15 psi Absolute	E	E
15 psi Differential	F	F
30 psi Absolute	G	G
30 psi Differential	H	H
100 psi Absolute	J	J
100 psi Differential	K	K

For Universal Direct Pressure IGYZ, the last digit of order code is always Z.

IP01: Process Loop, 4-20mA

IP02: Process Loop, 4-20mA with 24VDC EXC

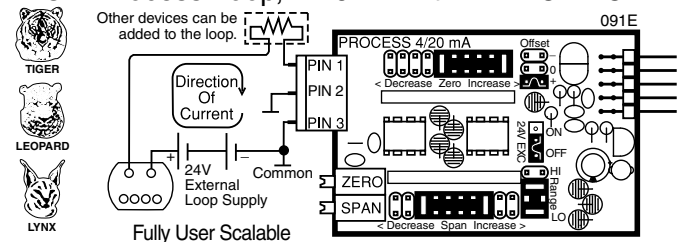

IP03: Process Input, 1-5V DC with Offset, 24V Exc

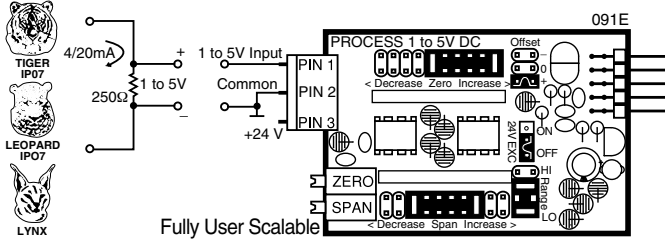

IP07: Universal Process Input 2V/5V/10V/20V/200V/2mA/20mA/Custom

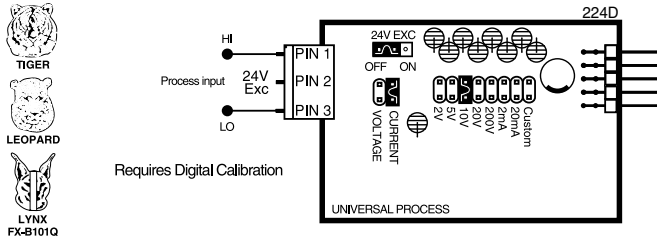

IPT1: Prototype Board for Custom Design

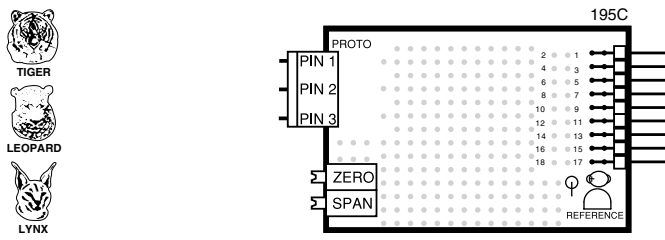

IR02: 3 wire Potentiometer 1KΩ min (0-F.S.)

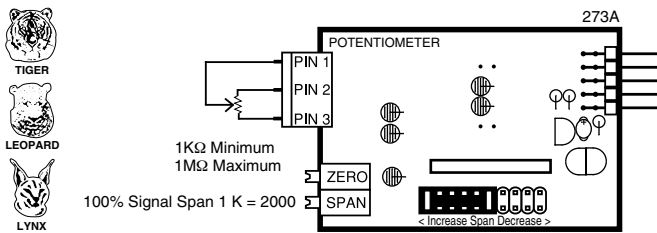

IR03: Linear Potentiometer 1KΩ min

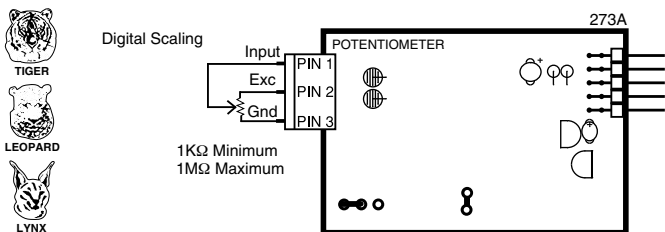

IS01: Strain Gage 5/10V DC Exc., 20/2mV/V, 4/6-wire

IS02: Pressure/Load Cell

5/10V DC Exc., 20/2mV/V, 4/6-wire

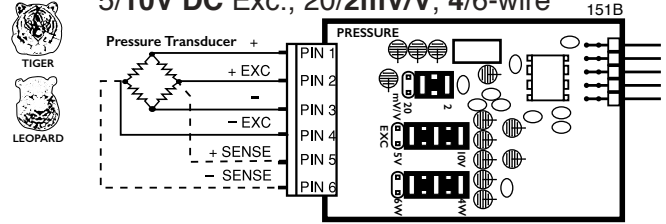

IS04: Pressure/Load Cell Ext Exc., 20/2mV/V, 4/6-wire

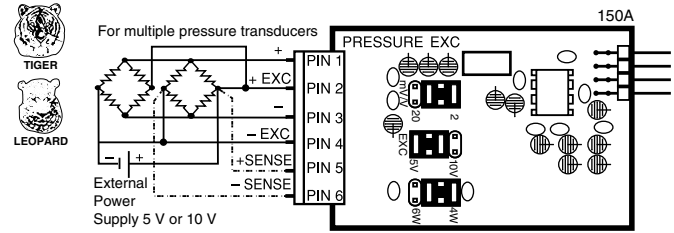

IS05: Pressure/Load Cell 20/2mV/V, 5/10V Exc 4-wire

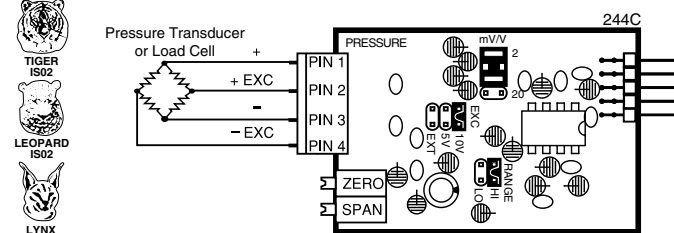

IS06: Pressure/Load Cell Ext Exc., 20/2mV/V, 4-wire

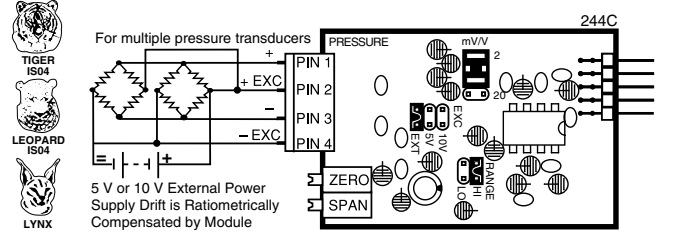

IS07: Pressure/Load Cell Ext Exc. High Impedance, 20/2mV/V, 4/6-wire

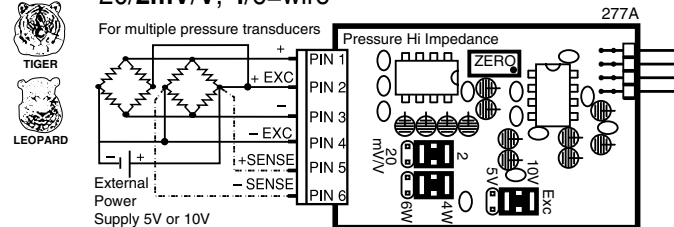

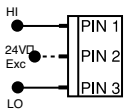

Input and Output Pins

On most modules Pin 1 is the Signal High input and Pin 3 is the Signal Low input. Typically Pin 2 is used for Excitation Voltage output.

INPUT RANGE Header

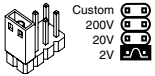

Range values are marked on the PCB. Typically two to four positions are provided, which are selected with either a single or multiple jumper clip. When provided, a custom range position is only functional when the option has been factory installed.



SPAN Potentiometer (Pot)

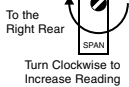

If provided, the 15 turn SPAN pot is always on the right side (as viewed from the rear of the meter). Typical adjustment is 20% of the input signal range.

SPAN ADJUST Header

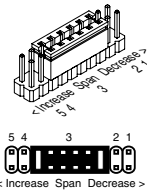

This unique five-position header expands the adjustment range of the SPAN pot into five equal 20% steps, across 100% of the input Signal Span. Any input Signal Span can then be precisely scaled down to provide any required Digital Display span from 1999 counts to 001 (one count).

SPAN Adjust Header position	1	2	3	4	5
SPAN Pot %	20%	20%	20%	20%	20%
Signal Span %	20%	40%	60%	80%	100%

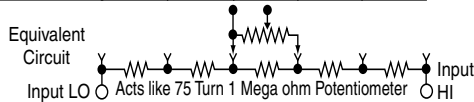

SPAN RANGE Header

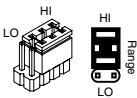

When this header is provided it works in conjunction with the SPAN ADJUST Header by splitting its adjustment range into a Hi and a Lo range. This has the effect of dividing the adjustment range of the SPAN pot into ten equal 10% steps across 100% of the input Signal Span.

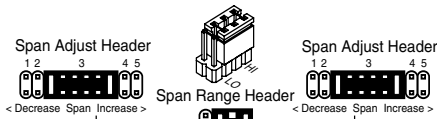

SPAN Adjust Header position	1	2	3	4	5	1	2	3	4	5
SPAN Pot %	10%	10%	10%	10%	10%	10%	10%	10%	10%	10%
Signal Span %	10%	20%	30%	40%	50%	60%	70%	80%	90%	100%

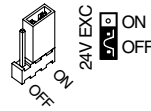
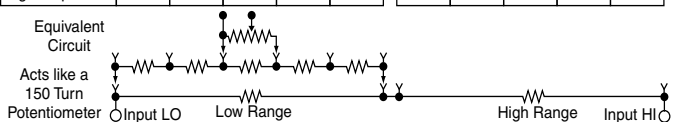

24V DC Output Header

On some modules this header enables a 24V DC 25mA (max) Excitation/Auxiliary output to be connected to Pin 2.

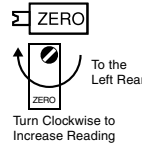

ZERO Potentiometer (Pot)

If provided, the ZERO pot is always to the left of the SPAN pot (as viewed from the rear of the meter). Typically it enables the input signal to be offset $\pm 5\%$ of full scale (-100 to +100 counts).

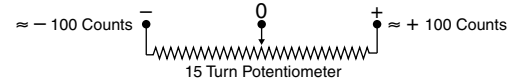

ZERO OFFSET RANGE Header

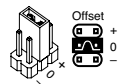

When provided, this three position header increases the ZERO pot's capability to offset the input signal, to $\pm 25\%$ of the digital display span. For example a Negative offset enables a 1 to 5V input to display 0 to full scale. The user can select negative offset, positive offset, or no offset (ZERO pot disabled for two step non-interactive span and offset calibration).

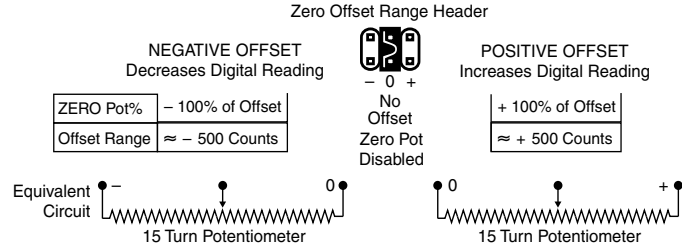

ZERO ADJUST Header

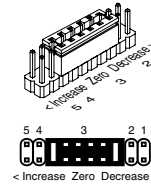

When this header is provided, it works in conjunction with the ZERO OFFSET RANGE Header, and expands the ZERO pot's offset capability into five equal negative steps or five equal positive steps. This enables virtually any degree of input signal offset required to display any desired engineering unit of measure.

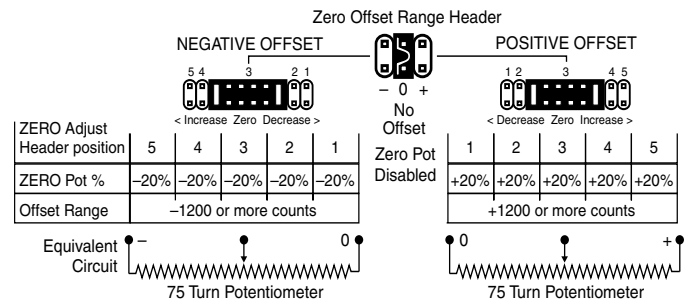

In addition to the analog calibration capabilities that enable many modules to be interchanged between different meters without loss of accuracy the Leopard Family of meters have enhanced Digital Calibration functions.

Basic standard range calibration of direct reading modules that utilize either Auto Zero or a ZERO pot, an INPUT RANGE Header and or a SPAN pot.

- 1 If the module has an INPUT RANGE Header, reposition the jumper clip to select the desired input signal range.
2. Apply a zero input or short the input pins. The display will auto zero, or if the module has a ZERO pot, it should be adjusted until the display reads zero.
- 3 Apply a known input signal that is at least 20% of the full scale input range and adjust the SPAN pot until the display reads the exact input value. For negative inputs, Leopard Family Meters will display negative overrange at 50% of full scale range.
- 4 Decimal Points. The selection or positioning of decimal points has no effect on the calibration of the modules

Wide range scaling, in engineering units not requiring offsets, with modules that utilize auto-zero or a ZERO pot, a SPAN RANGE Header and or a SPAN ADJUST Header.

Texmate's unique SPAN ADJUST and SPAN RANGE Headers provide the circuit equivalent of an ultra-precision one megohm 75 or 150 turn potentiometer that can infinitely scale down any Input Signal SPAN to provide any full scale Digital Display Span from 1999 (counts) to 001 (one count).

If the module has an INPUT RANGE Header, and the required full scale Digital Display Span (counts) is to be larger than the directly measured value of the input Signal Span, then the next lower range on the INPUT RANGE Header should be selected. The resulting over range Signal Span is then scaled down, by selecting the position of the SPAN RANGE Header and or the SPAN ADJUST Header, which will reduce the input Signal Span to a percentage, that the required Digital Display Span can be reached by calibration with the SPAN pot.

Example A: 0 to 10 V to read 0 to 1800 gallons.

Signal Span = 10V, Digital Display Span = 1800 counts

- 1 Select the 2 V INPUT RANGE Header position. This will provide a digital display of 1800 counts with an input of only 1.8 V which is $(1.8 \div 10) = 18\%$ of the examples 10 V Signal Span.
- 2 To scale down the Signal Span to 18% select the 20% Signal Span position on the SPAN ADJUST Header (position 1) or if the module has a SPAN RANGE Header, select (LO Range) and 20% Signal Span position on the SPAN ADJUST Header (position 2).
- 3 Apply a zero input or short the input pins. The display will auto zero, or if the module has a ZERO pot, it should be adjusted until the display reads zero.
- 4 Apply 10 V and adjust the SPAN pot until the display reads 1800.

Large offset scaling and calibration of process signal inputs with modules that utilize ZERO ADJUST Headers and or ZERO OFFSET RANGE Headers.

Texmate's unique ZERO OFFSET RANGE Header enables the use of a simple two step scaling and calibration procedure for those process signals that require large offsets. This eliminates the back and forth interaction, between zero and span settings, that is often required to calibrate less finely engineered products.

The first step is to set the ZERO OFFSET RANGE Header to the center position (No Offset) and scale down the Input Signal Span to a percentage that will enable calibration with the SPAN pot to reach the required Digital Display Span.

The second step is to set the ZERO ADJUST and or ZERO OFFSET RANGE Header to provide a positive or negative offset of sufficient counts that calibration with the ZERO pot will offset the Digital Display Span to produce the required digital reading.

Example B: 1 to 5 V to read -100 to 1500 °C.

Signal Span = 4V, Digital Display Span = 1600 counts

- 1 If the module has an INPUT RANGE Header the 2 V position should be selected. This will provide a digital display of 1600 counts for an input of 1.6 V which is $(1.6 \div 4) = 40\%$ of the examples 4 V signal span. To scale down the Signal Span to 40% select the 40% Signal Span position on the SPAN ADJUST Header (position 2).
- 2 If the module is a Process Input 1-5 V DC type, select the (Hi Range) position on the SPAN RANGE Header and the 100% Signal Span position on the SPAN ADJUST Header (position 5, max increase). This will provide a digital display of 1600 counts for an input of 4V which is 100% of the examples 4V Signal Span.
- 3 Set the ZERO OFFSET RANGE Header to the center position (no offset). Apply 1 V and adjust the SPAN pot until the display reads 400 . A 4V input would then read 1600 counts.
- 4 Set the ZERO OFFSET RANGE Header to the negative offset position. If the module has a ZERO ADJUST Header select the position that will provide a negative offset of ≈ -500 counts. Apply 1 V and adjust the ZERO pot until the display reads -100. Apply 5 V and check that the display reads 1500.

Example C: 4 to 20 mA to read 00.0 to +100.0%

Signal Span = 16 mA, Digital Display Span = 1000 counts.

- 1 The full scale Signal Span of the Process Input 4-20 mA modules is 0 to 20 mA for a full scale Digital Display Span of 0 to 2000 counts. This will provide a digital display of 1000 counts with an input of only 10 mA which is $(10 \div 16) = 62.5\%$ of the examples 16 mA signal span.
- 2 To scale down the Signal Span to 62.5% select the (Hi Range) Position on the Span Range Header and the 70% Signal Span position on the SPAN ADJUST Header (position 2).
- 3 Set the ZERO OFFSET RANGE Header to the center position (no offset). Apply 4 mA and adjust the SPAN pot until the display reads 250 . A 16 mA input would then read 1000 counts.
- 4 Set the ZERO OFFSET RANGE Header to the positive offset position. If the module has a ZERO ADJUST Header select the position that will provide a negative offset of ≈ -250 counts. Apply 4 mA and adjust the ZERO pot until the display reads 000. Apply 20 mA and check that the display reads 1000.

Installation

1. Install and wire meter per local applicable codes/regulations, the particular application, and good installation practices.
2. Install meter in a location that does not exceed the maximum operating temperature and that provides good air circulation.
3. Separate input/output leads from power lines to protect the meter from external noise. Input/output leads should be routed as far away as possible from contactors, control relays, transformers and other noisy components. Shielding cables for input/output leads is recommended with shield connection to earth ground near the meter preferred.
4. A circuit breaker or disconnect switch is required to disconnect power to the meter. The breaker/switch should be in close proximity to the meter and marked as the disconnecting device for the meter or meter circuit. The circuit breaker or wall switch must be rated for the applied voltage (e.g., 120VAC or 240VAC) and current appropriate for the electrical application (e.g., 15A or 20A).
5. See *Case Dimensions* section for panel cutout information.
6. See *Connector Pinouts* section for wiring.
7. Use 28-12 AWG wiring, minimum 90°C (HH) temperature rating. Strip wire approximately 0.3 in. (7-8 mm).
8. Recommended torque on all terminal plug screws is 4.5 lb-in (0.51 N-m).



Ordering Information

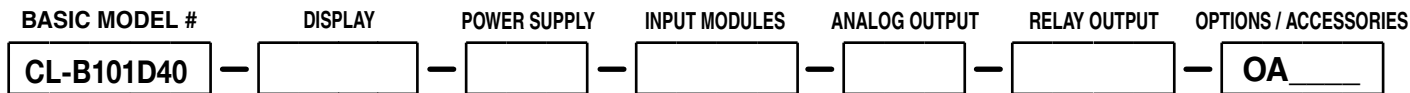

Add to the basic model number the order code suffix for each standard option required. The last suffix is to indicate how many different special options and or accessories that you may require to be included with this product.

Ordering Example: CL-B101D40-VRR-PS1-IA01-OIC-R11-OA2 plus ZR

► **BASIC MODEL NUMBER**

CL-B101D40... 114x114mm, 101 Segment Circular Bargraph with 4 Digit Display.....

Standard Options for this Model Number

Order Code Suffix	Description	List
-------------------	-------------	------

► **DISPLAY**

RR..... Red Circular 101 Segment LED Bar with 4 Digit Red LED Display
 GR ... Green Circular 101 Segment LED Bar with 4 Digit Red LED Display
 TR..... Tri-Color Circular 101 Segment LED Bar with 4 Digit Red LED Display.....

► **POWER SUPPLY**

PS1..... 85-265VAC/95-300VDC
 PS2..... 18-48VAC/10-72VDC

► **INPUT MODULES (Partial List. See www.texmate.com)**

Unless otherwise specified Texmate will ship all modules precalibrated with factory preselected ranges and/or scalings as shown in **BOLD** type.

IA06	AC-Volts True RMS, 200/ 300V AC
IA07	AC-Volts True RMS, 200mV/ 2V/20V AC
IA09	AC-Amps True RMS, 0-1 Amp AC (0-100.00)
IA11	AC-Amps True RMS, 0-5 Amp AC (0-100.00)
ID01	DC-Volts, 2/20/200V/Custom w/24V DC Exc
ID02	DC-Millivolt, 20/50/ 100/200mV DC w/24V DC Exc
ID03	DC-Milliamp, 2/ 20/200mA DC w/24V DC Exc
ID04	DC-Amps, 5A DC
ID07	DC-Milliamp, 2/ 20/200mA DC w/Offset and 24V Exc
ID09	DC-Amps, 1A DC
IGYZ	Universal Direct Pressure.

*View the IG- Ordering Code on page 13 to determine the value for Y & Z (IGAZ to IGKZ)

IP01	Process Loop, 4-20mA(0-100.00)
IP02	Process Loop, 4-20mA(0-100.00) w/24VDC Exc
IP03	Process Input, 1-5V DC(0-100.00) w/Offset, 24V Exc
IP07	Universal Process 2V/5V/ 10V/20V/200V/2mA/20mA/Custom
IR02	3-Wire Potentiometer 1KΩ min (0-F.S.)
IR03	Linear Potentiometer, 3-wire, 1KΩ min
IS01	Strain Gage 5/10VDC Exc., 20/ 2mV/V, 4/6-wire
IS02	Pressure 5/10VDC Exc., 20/ 2mV/V, 4/6-wire
IS04	Pressure Ext Exc., 20/ 2mV/V, 4/6-wire

► **ANALOG OUTPUT**

Note: If a meter is ordered with an Analog Output and/or Relay Output Module, an Output Module Carrier Board will be automatically added to the order.

OIC..... Isolated 16 Bit Current Output, 4-20mA
 OIV..... Isolated 16 Bit Voltage Output, 0-10VDC
 SA-CLCB Output Module Carrier Board

► **RELAY OUTPUT MODULES**

Note: If a meter is ordered with an Analog Output and/or Relay Output Module, an Output Module Carrier Board will be automatically added to the order.

SA-CLCB	Output Module Carrier Board
OR11	One 10 Amp Form C Relay, Isolated
OR15	One 10 Amp Form C and Two 5 Amps Form A Relays
OR16	One 10 Amp Form C and One 5 Amp Form A Relays
OR12	Two 10 Amp Form C Relays, Isolated
OR14	Two 10 Amp Form C and Two 5 Amps Form A Relays
OR23	Two 10 Amp Form C and One 5 Amp Form A Relay, Isolated
OR25	One 9A Form C & two 4A Form A relays. Isolated
OR31	One 5 Amp Form A Relay, Isolated
OR32	Two 5 Amp Form A Relays, Isolated
OR33	Three 5 Amp Form A Relays, Isolated
OR34	Four 5 Amp Form A Relays, Isolated

Solid State Relay (SSR) Output Modules DC Only

OR51	One 400V DC Solid State Relay (SSR) 210mA
OR52	Two 400V DC Solid State Relays (SSR) 210mA
OR53	Three 400V DC Solid State Relays (SSR) 210mA
OR54	Four 400V DC Solid State Relays (SSR) 210mA

Special Options and Accessories

Part Number	Description	List
-------------	-------------	------

► **SPECIAL OPTIONS (Specify Inputs or Outputs & Req. Reading)**

ZR	Range change from Standard Range shown in BOLD Type
ZS	Custom Digital Display Scaling within Standard Ranges
CS-BAR	Custom Bargraph Display Scaling within Standard Range
ZS-AO	Custom Scaling of Analog Output
ART-FS1	Produce and install custom faceplate per meter - 1 color
ART-FS2	Produce and install custom faceplate per meter - 2 color
ART-FS3	Produce and install custom faceplate per meter - 3 color
ART-FS4	Produce and install custom faceplate per meter - 4 color
ART-NRC-DEC	NRC for Artwork & set-up Custom Faceplate and/or Descriptor

► **ACCESSORIES (Specify Serial # for Custom Artwork Installation)**

93-PLUG2P-DP	Extra Screw Terminal Conn., 2 Pin Power Plug
93-PLUG2P-DR	Extra Screw Terminal Conn., 2 Pin Plug
93-PLUG3P-DR	Extra Screw Terminal Conn., 3 Pin Plug
93-PLUG4P-DR	Extra Screw Terminal Conn., 4 Pin Plug
93-PLUG5P-DR	Extra Screw Terminal Conn., 5 Pin Plug

Prices subject to change without notice

WARRANTY

Texmate warrants that its products are free from defects in material and workmanship under normal use and service for a period of one year from date of shipment. Texmate's obligations under this warranty are limited to replacement or repair, at its option, at its factory, of any of the products which shall, within the applicable period after shipment, be returned to Texmate's facility, transportation charges pre-paid, and which are, after examination, disclosed to the satisfaction of Texmate to be thus defective. The warranty shall not apply to any equipment which shall have been repaired or altered, except by Texmate, or which shall have been subjected to misuse, negligence, or accident. In no case shall Texmate's liability exceed the original purchase price. The aforementioned provisions do not extend the original warranty period of any product which has been either repaired or replaced by Texmate.

USER'S RESPONSIBILITY

We are pleased to offer suggestions on the use of our various products either by way of printed matter or through direct contact with our sales/application engineering staff. However, since we have no control over the use of our products once they are shipped, **NO WARRANTY WHETHER OF MERCHANTABILITY, FITNESS FOR PURPOSE, OR OTHERWISE** is made beyond the repair, replacement, or refund of purchase price at the sole discretion of Texmate. Users shall determine the suitability of the product for the intended application before using, and the users assume all risk and liability whatsoever in connection therewith, regardless of any of our suggestions or statements as to application or construction. In no event shall Texmate's liability, in law or otherwise, be in excess of the purchase price of the product.

Texmate cannot assume responsibility for any circuitry described. No circuit patent or software licenses are implied. Texmate reserves the right to change circuitry, operating software, specifications, and prices without notice at any time.



1934 Kellogg Ave., Carlsbad, CA 92008
 Tel: 1-760-598-9899 • 1-800-TEXMATE
 Fax: 1-760-598-9828 • Email: orders@texmate.com

CL-B101D40 Technical Manual Copyright © 2020 Texmate Inc. All rights reserved. Published by: Texmate Inc. USA. Information in this Technical Manual is subject to change without notice due to correction or enhancement. The information described in this manual is proprietary to Texmate, Inc. and may not be copied, reproduced or transmitted, in whole or in part, in connection with the design, manufacture, or sale of apparatus, device or private label product without the express written consent of Texmate, Inc.