

**101 Segment in  
9/64 DIN Case**



Optional  
Green LED Display  
Optional  
Horizontal Display



LYNX FAMILY



**FX-B101Q-DCA**  
20/50/100/200mV DC Full Scale  
**FX-B101Q-DCV**  
2/20/200V DC Meter

**A Powerful Smart DCA/DCV Bargraph  
with optional  
Isolated 4-20mA DC or 0-10VDC output**

**Specifications**

- Input Specs:**.....Single-ended, however isolated power supply enables differential measurements up to a maximum common mode of 50V.
- A/D Converter:** .....14 bit single slope
- Accuracy:** .....±(0.05% of reading + 1 segment)
- Temp. Coeff.:**.....100 ppm/°C (Typical)
- Warm up time:**.....2 minutes
- Conversion Rate:**.....10 conversions per second (Typical)
- Bargraph Display:**.....**101 segment 4" vertical (std)**, horizontal (optn), **red (std)**, green (optn)
- Polarity:** .....Selectable center zero
- Positive Overrange:**..Bargraph display flashes
- Negative Overrange:** First segment of bargraph display flashes
- Analog Output:** .....Isolated 16 bit user scalable mA or V  
**OIC (mA out)** .....4-20 mA @ 0 to 500Ω max loop resistance  
**OIV (volts out)** ..... 0-10 V DC @ 500 Ω or higher resistance
- Power Supply:**.....AC/DC Auto sensing wide range supply  
**PS1 (std)**.....**85-265 VAC, 50-400Hz / 95-300 VDC @ 1.5W**  
**PS2** ..... 14-48 V AC, 50-400Hz / 10-72 V DC @1.5W
- Operating Temp.:** .....0 to 50°C
- Storage Temp.:**.....-20°C to 70°C
- Relative Humidity:** .....95% (non condensing)
- Case Dimensions:** .....9/64 DIN Bezel: 36x144mm(1.42"x5.69")  
Depth behind bezel:117.5mm(4.64").  
Plus 10mm(0.39") for Right-angled connector, or plus 18.3mm(0.72") for Straight-thru connectors.
- Weight:**.....9.5 oz., 12 oz when packed

**Input Module Compatibility**

**LYNX FAMILY:** More than 33 different Plug-in I-Series Input Signal Conditioners are approved for Texmate's Lynx Family of meters.

See [www.texmate.com](http://www.texmate.com) for an up to date listing.



LYNX

**General Features**

- External transmitters or signal conditioners can be eliminated by directly connecting the sensor to Plug-in Input Signal Conditioning Modules that include:
  - DCA  
ID02 : DC mV ±20mV, ±50mV, **±100mV**, ±200mV w/24V Exc.
  - DCV  
ID01 : DC-Volts **2V/20V/200V** w/24V Exc.  
ID05 : DC-Volts **2V/20V/200V** w/24V Exc. and Zero offset adjustable pot
- A red or optional green 101 segment bargraph.
- Auto-sensing AC/DC power supply. For voltages between **85-265 V AC / 95-300 V DC (PS1)** or 14-48 V AC / 10-72 V DC (PS2).
- Optional 16 Bit isolated analog output that can be used to drive an external process device such as a chart recorder, remote display, or for retransmission to a central control room. User or factory scalable to 4 to 20 mA, 0 to 20 mA or 0 to 10 V across any desired span from ± one bar to the full scale range
- Center zero setting, header selectable.
- Provision for external brightness setting switch (by connecting the DIM to the GND pin on the back of the meter).
- Smart averaging (to speed up display response).
- Optional NEMA-4 front cover.
- UL Listed

**Index**

Analog Output Scaling and Calibration . . . . . 6	Glossary of Programming Symbols & Modes of Operation . . . . . 2	One Point Quickset Rescaling and Calibration Procedure. . . . . 5	Panel Adapter. . . . . 11
Case Dimensions . . . . . 12	Hinged Clear Lockable Poly NEMA 4X Splash Proof Cover . . . . . 12	Opening the Case to Access Mode . . . . . 4	Pin Descriptions . . . . . 7
Component Layout. . . . . 8	Input Module Compatibility. . . . . 1	Select Header. . . . . 4	Specifications . . . . . 1
Connector Pinouts . . . . . 7	Input Module Component Glossary . . . . . 9	Ordering Information . . . . . 13	Standard Display Mode Calibration Procedure. . . . . 5
Connectors . . . . . 7	Installation Guideline . . . . . 7	Overview of Display Modes, Scaling Capabilities & Operating Modes. . . . . 3	Two Point Quickset Scaling and Calibration . . . . . 3,5
Controls and Indicators . . . . . 2			
Custom Face Plates . . . . . 1			
General Features . . . . . 1			

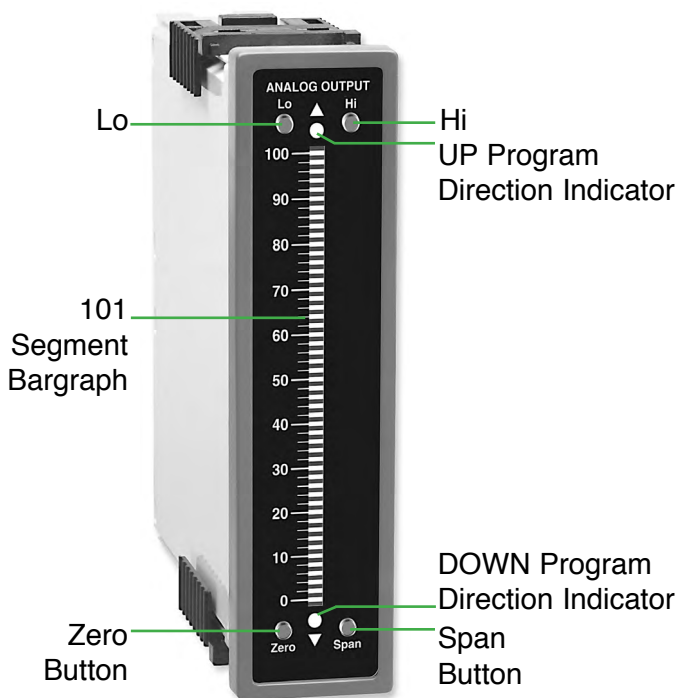

directly changed. The direction of change will be either up or down, as indicated by the UP and DOWN indicator LEDs. After the indicator LED lights up there is a 0.5 second delay before any change occurs. When a button is released and pressed down again the direction of change is reversed. As there are no menu or sub-menus to navigate, the programming and setup is quick and easy.

## Front Panel Buttons

### Zero Button

The Zero Button sets the low input signal scaling.

### Span Button

The Span Button sets the high input signal scaling.

### Lo Button

The Lo Button sets the analog output low setting.

### Hi Button

The Hi Button sets the analog output high setting.

## Quickset Programming

This bargraph features Texmate's unique QUICKSET PROGRAMMING. When a front panel button is pressed and held down, the associated function is

## Glossary of Programming Symbols and Modes of Operation

To explain software programming procedures, logic diagrams are used to visually assist in following programming steps. The following symbols are used to represent the functions and displays of the meter:

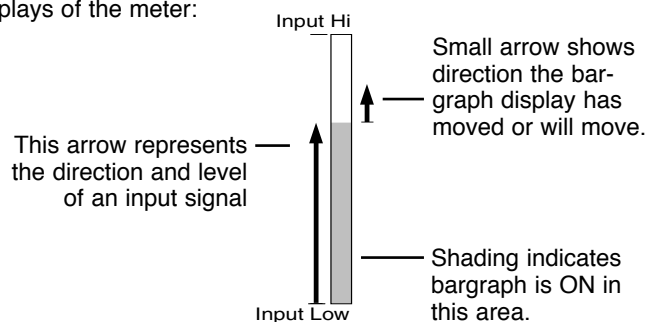

## Standard or Center Zero Display Mode Select Header

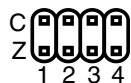

•Jumper clips enables standard display.



•Jumper clip to enable Center Zero display.



## Horizontal and Reverse Mounting

with Custom Face Plate Installed

### Horizontal or Reverse Mounting

Meters can be mounted horizontally in the panel and for those applications that require an opposite growth of the bar, the meter can be vertically or horizontally mounted upside down

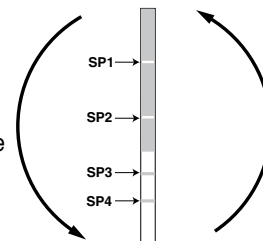

When two fingers are shown side by side, the two corresponding buttons must be pressed at the same time to initiate an indicated function.

## Over View of Display Modes, Scaling Capabilities and Operating Modes

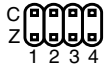

### Standard Display Mode

#### Standard Scaling

Standard display mode selected and scaled so bar increases as input signal increases from Low to Hi.

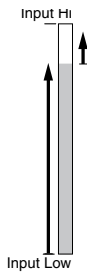

#### Inverse Scaling

Standard display mode selected and scaled so the bar increases as the input signal decreases from Hi to Low.

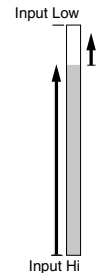

### Center Zero Display Mode

#### Bipolar Center Zero

Center point display mode selected and scaled, so the bar increases upward from zero, for increasing positive inputs and downward from zero for increasing negative inputs. When the input is zero, only the center segment will be on.

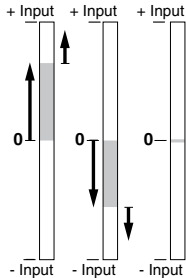

#### Halfway Zero Point

Center point display mode selected and scaled, so the bar increases upwards or downwards from the center point, for signals that are greater or less than half the calibrated full scale range respectively. When the input is equal to half the full scale range, only the center segment will be on.

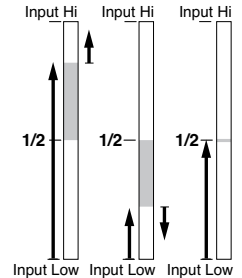

## Two Point Quickset Scaling and Calibration

Meters with **QUICKSET PROGRAMMING** feature a unique, easy-to-use, two point scaling and calibration system.

Scaling or calibration is accomplished simply, by applying a zero or low input signal and adjusting the bar to the desired reading, using the ZER0 button. A higher input signal is then applied, and the bar is adjusted to the desired reading for that input value, using the SPAN button.

### IMPORTANT DETAILS THAT MAKE QUICKSET PROGRAMMING EASY TO USE AND UNDERSTAND

1. The zero and span buttons are functionally the same, except as follows: The ZERO button can initiate a scaling with input signals from zero to 95% of fullscale. The Span button can initiate a scaling with input signals from 5% of fullscale to 105% of fullscale.
2. When a Zero or Span button is pressed, the Up or Down indicator LED will immediately light up to show the direction, in which the Bar will move, after a 0.5 second delay. If the button is released and pressed again, the opposite Up or Down indicator will light up, and 0.5 seconds later the Bar will begin to move in that direction until the button is released. When the bar is being adjusted to zero or fullscale, the bar will automatically stop at the zero or fullscale position, and will not overshoot these positions, even if the button continues to be pressed.
3. While the bar is being adjusted, a new offset and scale factor is continuously being calculated. At the moment the button is released, and the scaling is accepted, the calculation data is memorized and implemented. The Scaling calculation is based on the new position of the Bar, the input signal being applied at that moment, and the previously memorized position of the Bar and the input signal that was being applied, when the other button was last released.
4. Positive and negative signals maybe integrated into a two point scaling. However when either a ZERO or SPAN button is pressed the input signal being applied, must be more than 5% higher or lower than the previously memorized value of the input signal, that was being applied when the other button was last released. If not, the bar will flash, the scaling will not be accepted, and the previous scaling will still be retained in memory.
5. Because of the requirement, that a new scaling input signal must be 5% higher or lower than the previously stored value, it can sometimes be difficult to implement a desired scaling, particularly when using a calibrator that only has fixed output values. In this case Reset the Scaling by pressing the ZERO and SPAN buttons simultaneously for two seconds. Both scaling memories will be erased and an internal default scale factor will be loaded. This provides a display of zero to fullscale on the bar for an input of approximately 0 to 100% of the range selected on the input signal conditioning module. After Resetting the Scaling a new calibration, using either button, can be implemented with new input signal values. It is good practice to always use the Zero button for lower input signals and the Span button for higher input signals, even when the bar display scale is inverted.
6. The larger the difference between two points used for calibration, the better the accuracy. However if the difference is too high, and the output from the input signal conditioning module is greater than +2.1VDC, or less than -1.05VDC, the bar will flash over range. The calibration will not then be accepted and, the previous scaling will still be retained in memory. In this case, either a lower input signal must be used, or a higher range on the input module should be selected to recalibrate the meter.

**Note:** Most input signal conditioners have provisions for analog calibration and scaling. If the meter's scale factor is set to read zero with a zero input (shorted input), and to read 10 Bars fullscale with a 2.000 V input, any pre-calibrated signal conditioner with an output that does not exceed - 1 V to + 2 V, will read correctly in the meter without any further calibration.

To remove front bezel lightly lever the plastic catches up and forward in the sequence shown by the numbers

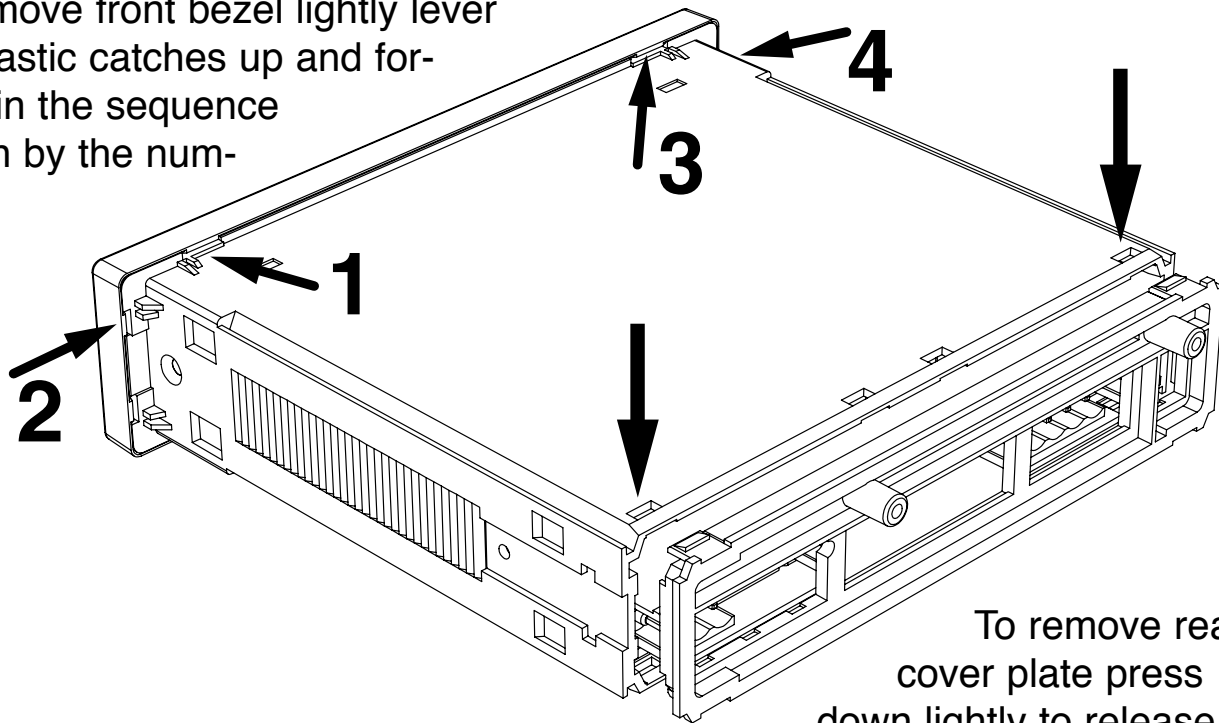

To remove rear cover plate press down lightly to release two plastic catches, on either side of the case and lever backwards.

**Meter Exploded view**

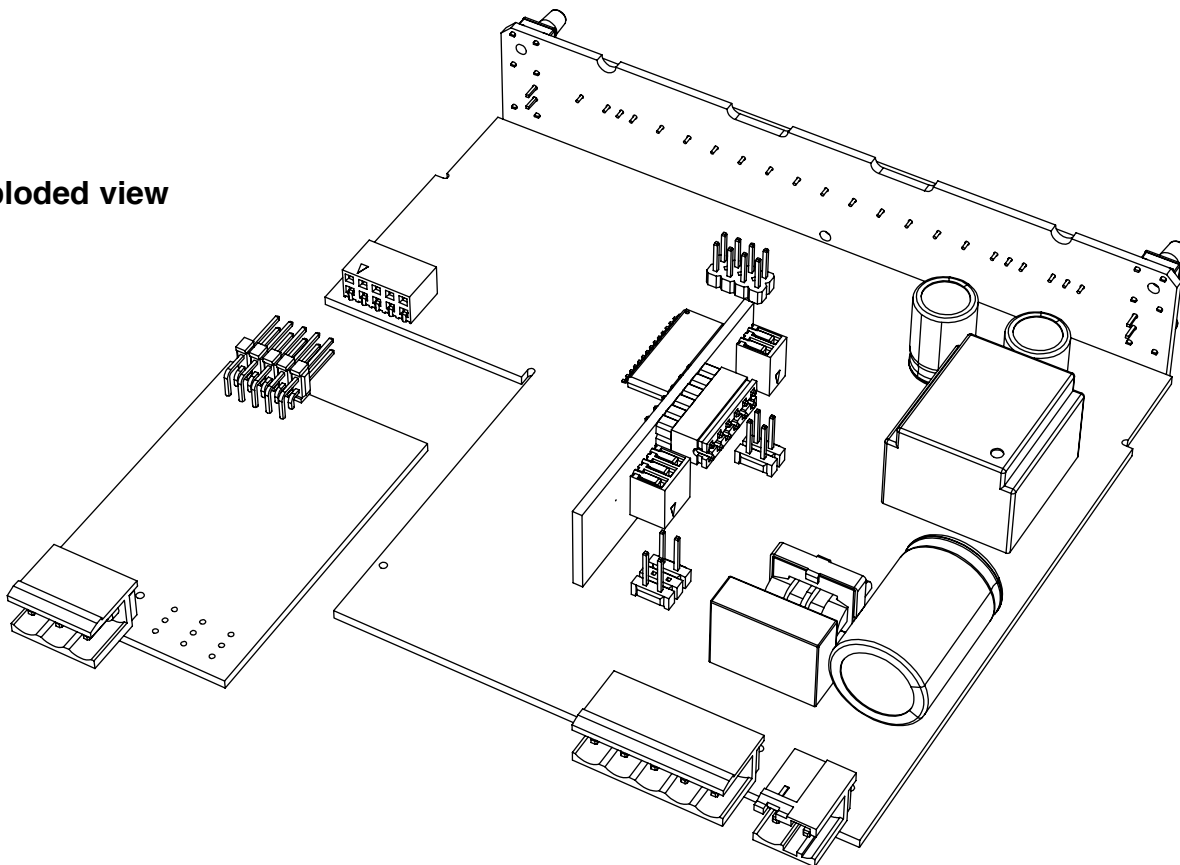

## Standard Display Mode Calibration Procedure

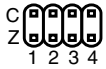

Standard Display with Jumper Clips in OFF position

**Standard or Center Zero Display Mode** may be selected, depending on the Operating Mode selected. If the standard display mode is not already selected open the meter case as showing on page 4 and move the jumper clips on the display mode select header to the OFF position.

### STEP A REVIEW THE INPUT MODULE STATUS

- 1) See pages 10 – 15 for information on input modules that may be used with this meter.
- 2) Confirm that the correct range and input is selected on the input signal conditioning module.

**Note:** When undertaking an initial set up and primary scaling and calibration of the meter it is best to start with a reset of the scaling.

### STEP B RESET THE SCALING

- 1) Apply power to the meter and press the ZERO and SPAN buttons simultaneously for 2 seconds. This erases any previously memorized scalings, and resets the scaling to the factory default, of approximately zero to full scale, for an input, that is 0 to 100% of the range selected on the input signal conditioner.

Reset the scaling to the default value on by pressing the Zero and Span buttons simultaneously for 2 secs.

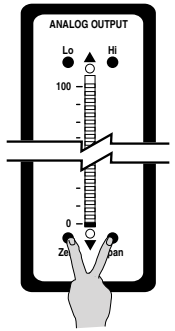

## Two Point Quickset Scaling and Calibration Procedure (continued)

**Note:** To calibrate the bargraph you must be able to input two input signals. Usually the minimum input (LO Input) and the maximum input (HI Input) signals are used for optimum accuracy. However a scaling can be accomplished with any two signals that are higher or lower than each other by more than 5% of fullscale and are not greater than +2.1VDC or less than -1.05VDC.

### STEP C SET THE LOW INPUT SIGNAL READING ON THE BAR

- 1) Apply the LO input signal (4ma in this example) to the input pins.
- 2) Using the ZERO button adjust the bar down to the required position.

Apply 4 mA to the Input Pins and adjust bar display to the required position

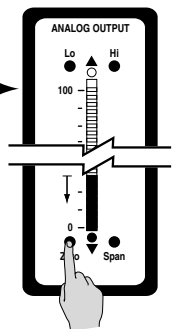

### STEP D SET THE HIGH INPUT SIGNAL READING ON THE BAR

- 1) Apply the high input signal (20mA in this example) to the input pins. Using the SPAN button adjust the bar to the required position. This position could be higher or lower than the position adjusted in Step 2. The scaling for an input of 4 to 20mA is now complete.

Apply 20 mA to the Input Pins and adjust bar display to the required position

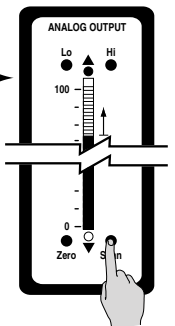

## One Point Quickset Rescaling and Calibration Procedure

### ONE POINT RECALIBRATION

As explained earlier, the FX-B101Q bargraph is calibrated using two point calibration. Once a bargraph is calibrated, the low end of the range may be then recalibrated without affecting the calibration of the high end, and vice versa.

For example, take an FX-B101Q that has been calibrated to read zero to full scale for an input of 4 to 20mA. If now the scaling has to be changed to read zero to full scale for an input of 0 to 20mA, only the low (4 mA) end needs to be recalibrated. The high (20 mA) end of the scaling is left untouched, and so does not change. The following one point recalibration procedure is used for this purpose.

### STEP A RECALIBRATE THE LOW INPUT SIGNAL READING ON THE BAR

- 1) Apply the LO input signal (0ma in this example) to the input pins. The first segment will flash, indicating an under range condition.
- 2) Using the ZERO button adjust the bar up to the required position.
- 3) The FX-B101Q has now been recalibrated to read zero to fullscale for a 0 to 20 mA input.

Apply 0 mA to the Input Pins and adjust bar display to the required position

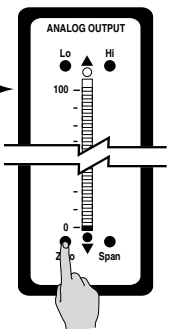

## Analog Output Scaling and Calibration

When the optional analog output module is installed, an independently calibrated 16 bit isolated, voltage or current analog output is available. **The analog signal is independently scaled to the input signal and not to the bargraph display.** It is important to note that the Analog Output is completely independently of the bargraph display. This means for example that the bargraph display may be scaled to go from zero to full scale as the input changes from 0 to 5V, while at the same time, the analog output is scaled to go from 4 to 20mA as the input changes from 2 to 3V. Rescaling the bargraph or the analog output will not affect the scaling of the other.

To calibrate the Analog Output you must be able to input two input signals. Usually the minimum input (LO Input) and the maximum (HI Input) signals are used for maximum accuracy.

For example: the three steps to obtain an Analog Output of 4mA to 20mA for an input of 0 to 10V are:

### STEP A RESET THE ANALOG OUTPUT SCALING

- 1) Press the LO and HI buttons simultaneously and hold them down for 2 seconds. This will reset the analog output scaling to the default value. The default analog output scaling is approximately 0 to 20mA (0 to 10V if voltage output option is selected) for an input that is 0 to 100% of the range selected on the input signal conditioner.

Reset the analog output scaling by pressing the LO and HI buttons simultaneously for 2 secs.

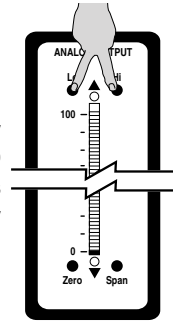

### STEP B CALIBRATE ANALOG OUTPUT FOR LO SIGNAL

- 1) Apply the low input signal (0V in this example) to the meter.
- 2) Connect an external multimeter to the analog output pins (Pins 17 and 18).
- 3) Using the LO button adjust the analog output as measured on the external multimeter to be the required value. (4mA in this example). When the LO button is pressed, the UP or DOWN indicator LED shows the direction of change. To reverse the direction of change release the LO button and press down again. Initially the output changes very slowly, but speeds up as the LO button remains pressed down. The analog output for a low input can be set in this step to any value in the range of 0 to 20mA or 0 to 10V ( if the voltage output option is selected).

Apply 0 V to the Input Signal Pins

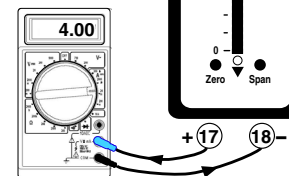

Adjust the Analog output to 4.00mA

### STEP C CALIBRATE ANALOG OUTPUT FOR HI SIGNAL

- 1) Next apply the high input signal (10V in this example) to the meter.
- 2) Using the HI button, adjust the analog output as measured on the external multimeter to be the required value. (20mA in this example). When the HI button is pressed the UP or DOWN indicator LED shows the direction of change. Release the HI button and press again to reverse the direction of change. Initially the output changes very slowly, but speeds up as the HI button continues to remain pressed. This output may be higher or lower than the value set in Step 2, and may be any value in the range of 0 to 20mA or 0 to 10V. This allows the easy reversal of analog output that is required in some applications.

Apply 10 V to the Input Signal Pins

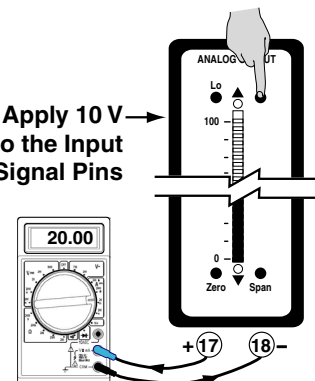

Adjust the Analog output to 20.00mA

## Connector Pinouts

This meter uses plug-in type screw terminal connectors for all input and output connections. The power supply connections (pins 23 and 24) have a unique plug and socket outline to prevent cross connection. The main board uses standard right-angled connectors. Replacement 2-, 3-, and 4-pin plug connectors are available.

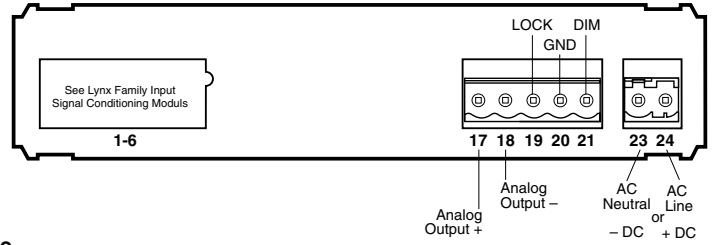

### WARNING

AC and DC power supply voltages are hazardous. Make sure the power supply is isolated before connecting to the meter.

## Connectors

Standard plug-in screw terminal blocks provided by Texmate:

### WARNING

AC and DC input signals and power supply voltages can be hazardous. Do Not connect live wires to terminal blocks, and do not insert, remove or handle terminal blocks with live wires connected.

#### Input Power Screw Terminal Plug

Part Number:  
93-PLUG2P-DP

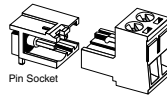

#### Right-angled Screw Terminal Plug

Part Numbers:  
93-PLUG2P-DR...2 pins  
93-PLUG3P-DR...3 pins  
93-PLUG4P-DR...4 pins  
93-PLUG5P-DR...5 pins  
93-PLUG6P-DR...6 pins

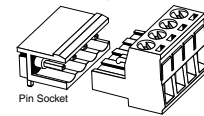

#### Straight-thru Input Power Screw Terminal Plug

Part Number:  
93-PLUG2P-SP

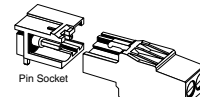

#### Straight-thru Screw Terminal Plug

Part Numbers:  
93-PLUG2P-DS...2 pins  
93-PLUG3P-DS...3 pins  
93-PLUG4P-DS...4 pins

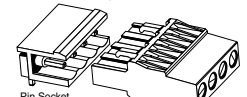

## Pin Descriptions

### Input Signal – Pins 1 to 6

Pins 1 to 6 are reserved for the input signal conditioner. See the data sheet for the selected input signal conditioner.

### Rear Panel Switches – Pins 17 to 21

**Pin 17 ANALOG OUTPUT (+).** mA (0 to 20 mA/4 to 20 mA) or V (0 to 10 V) output is header selectable.

**Pin 18 ANALOG OUTPUT (-).** mA (0 to 20 mA/4 to 20 mA) or V (0 to 10 V) output is header selectable.

**Pin 19 Programming LOCK.** By connecting the LOCK pin to the COMMON pin, the meter's programmed parameters can be viewed but not changed.

**Pin 20 COMMON.** To activate the LOCK or DIM functions from the rear of the meter, the respective pins have to be connected to the COMMON pin. This pin is connected to the internal power supply ground.

**Pin 21 DIM.** By connecting the display dim (DIM) pin to the COMMON pin, the display brightness setting is halved.

### Pins 23 and 24 – AC/DC Power Input

Auto-sensing AC/DC power supply. For voltages between 85-265 V AC, 50~400Hz / 95-300 V DC (PS1) or optional 14-48 V AC 50~400Hz / 10-72 V DC 1.5W nominal. (PS2).

**Pin 23 AC Neutral / -DC.** Neutral power supply line.

**Pin 24 AC line / +DC.** Live power supply line.

## Installation Guidelines

### Installation

1. Install and wire meter per local applicable codes/regulations, the particular application, and good installation practices.
2. Install meter in a location that does not exceed the maximum operating temperature and that provides good air circulation.
3. Separate input/output leads from power lines to protect the meter from external noise. Input/output leads should be routed as far away as possible from contactors, control relays, transformers and other noisy components. Shielding cables for input/output leads is recommended with shield connection to earth ground near the meter preferred.
4. A circuit breaker or disconnect switch is required to disconnect power to the meter. The breaker/switch should be in close proximity to the meter and marked as the disconnecting device for the meter or meter circuit. The circuit breaker or wall switch must be rated for the applied voltage (e.g., 120VAC or 240VAC) and current appropriate for the electrical application (e.g., 15A or 20A).
5. See *Case Dimensions* section for panel cutout information.
6. See *Connector Pinouts* section for wiring.
7. Use 28-12 AWG wiring, minimum 90°C (HH) temperature rating. Strip wire approximately 0.3 in. (7-8 mm).
8. Recommended torque on all terminal plug screws is 4.5 lb-in (0.51 N-m).



**MAIN BOARD**

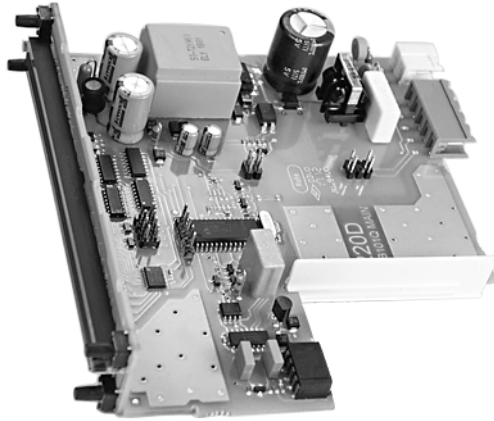

Hi Voltage

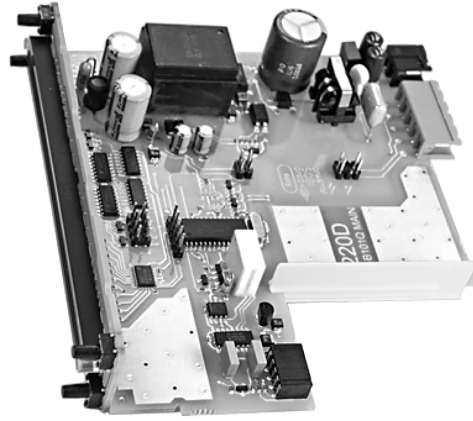

Low Voltage

**DC VOLTS INPUT MODULE**

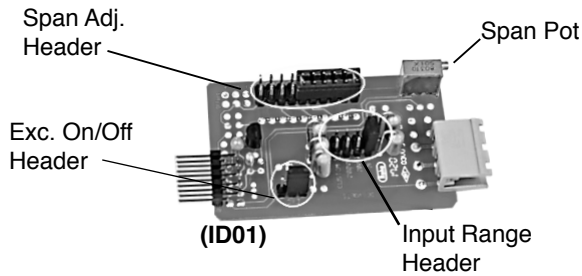

ID01: DC Volts, 2/20/200V/Custom w/24V DC Exc

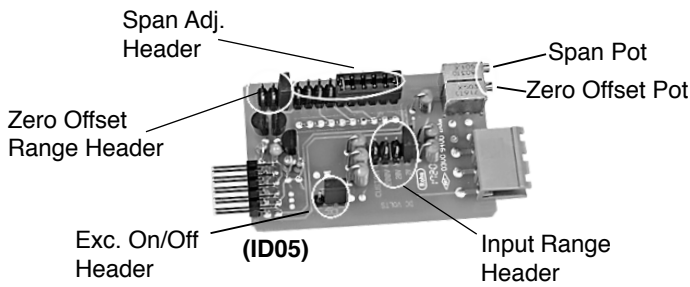
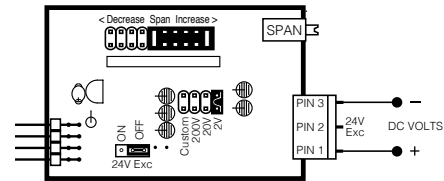

ID05: DC Volts 2/20/200/Custom V DC with Offset and 24V Exc.

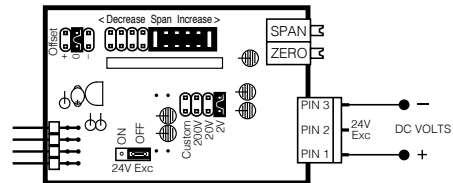

**DC AMPS INPUT MODULE** : to be used with 50mV/60mV/100mV/120mV Shunts

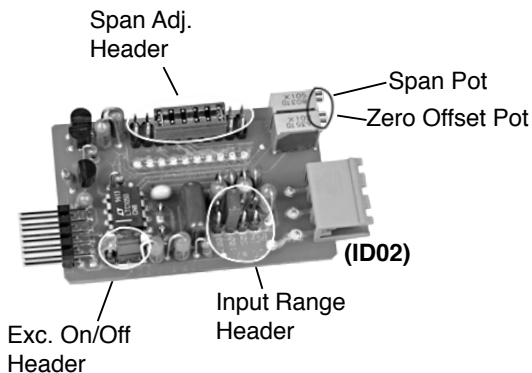

ID02: DC Millivolts, 20/50/100/200mV DC w/24V DC Exc

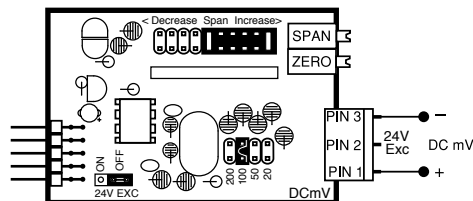



## SPAN ADJUST Header

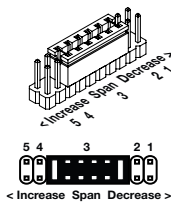

This unique five-position header expands the adjustment range of the SPAN pot into five equal 20% steps, across 100% of the input Signal Span. Any input Signal Span can then be precisely scaled down to provide any required Digital Display span from 1999 counts to 001 (one count).

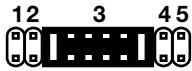

SPAN Adjust Header position	1	2	3	4	5
SPAN Pot %	20%	20%	20%	20%	20%
Signal Span %	20%	40%	60%	80%	100%

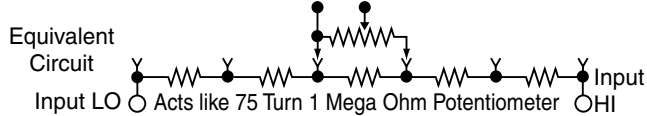

## SPAN RANGE Header

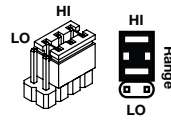

When this header is provided it works in conjunction with the SPAN ADJUST Header by splitting its adjustment range into a Hi and a Lo range. This has the effect of dividing the adjustment range of the SPAN pot into ten equal 10% steps across 100% of the input Signal Span.

SPAN Adjust Header position	1	2	3	4	5	1	2	3	4	5
SPAN Pot %	10%	10%	10%	10%	10%	10%	10%	10%	10%	10%
Signal Span %	10%	20%	30%	40%	50%	60%	70%	80%	90%	100%

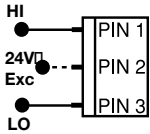
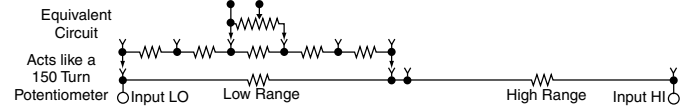

## Input and Output Pins

On most modules Pin 1 is the Signal High input and Pin 3 is the Signal Low input. Typically Pin 2 is used for Excitation Voltage output.

## INPUT RANGE Header

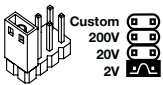

Range values are marked on the PCB. Typically two to four positions are provided, which are selected with either a single or multiple jumper clip. When provided, a custom range position is only functional when the option has been factory installed.



## SPAN Potentiometer (Pot)

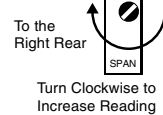

If provided, the 15 turn SPAN pot is always on the right side (as viewed from the rear of the meter). Typical adjustment is 20% of the input signal range.



## ZERO Potentiometer (Pot)

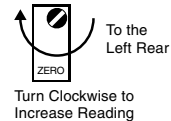

If provided, the ZERO pot is always to the left of the SPAN pot (as viewed from the rear of the meter). Typically it enables the input signal to be offset  $\pm 5\%$  of full scale (-100 to +100 counts).

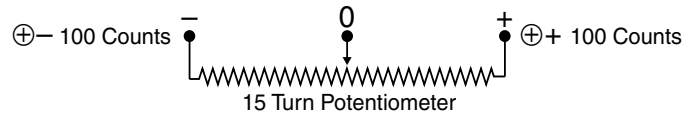



• Custom face plates have a non-recurring artwork charge. A serial number is then assigned to each artwork, to facilitate re-ordering.

- Small Run or One-Off custom face plates incur an installation charge, and are generally printed on a special plastic film, which is then laminated to custom faceplate blanks as required.
- Large Run (300 pieces min): custom face plates are production silk screened, issued a part number.

<i>Part Number</i>	<i>Description</i>	<i>List</i>
--------------------	--------------------	-------------

**Small Run Custom Face plates for Bargraphs**

ART-NRC-DES . . . . .	Small run NRC custom faceplate design. . . . .	
ART-NRC-LOGO. . . . .	Small run NRC custom faceplate design with Co.Logo . . . . .	
ART-FS1 . . . . .	Small run custom Faceplate - 1 color . . . . .	
ART-FS2 . . . . .	Small run custom Faceplate - 2 color . . . . .	
ART-FS3 . . . . .	Small run custom Faceplate - 3 color . . . . .	
ART-FS4 . . . . .	Small run custom Faceplate - 4 color . . . . .	
ART-FS5 . . . . .	Small run custom Faceplate - 5 color . . . . .	

Specify artwork serial number when ordering face plate installation.  
ie: AFB-XXXXX

**Large Run Custom Face plates for Bargraphs**

ART-NRC-FILM. . . . .	Large run NRC custom faceplate design & films. . . . .	
ART-FPMAINT . . . . .	Inventory management fee for 2 years . . . . .	
ART-FL1 . . . . .	Large run 300pcs custom faceplate - 1 color . . . . .	
ART-FL2 . . . . .	Large run 300pcs custom faceplate - 2 color . . . . .	
ART-FL3 . . . . .	Large run 300pcs custom faceplate - 3 color . . . . .	
ART-FL4 . . . . .	Large run 300pcs custom faceplate - 4 color . . . . .	
ART-FL5 . . . . .	Large run 300pcs custom faceplate - 5 color . . . . .	

When ordering Large Run Face plates to be installed specify the custom part number issued for each different artwork. ie: 77-FLXXXXX

**Fits 6" Edgewise Pointer Meter Cut-Outs**

The adapter snaps on the 36x144 mm (1.42"x5.69") case and enables single unit or stack mounting in an existing 6" edgewise pointer meter cut-out.

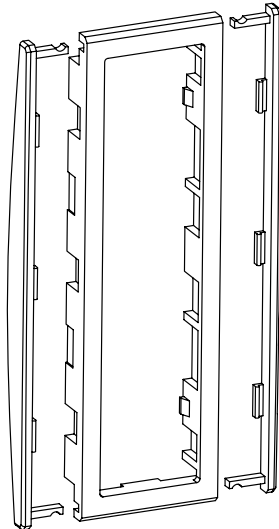

**Panel Adapter**  
Part #: OP-PA/144X36

**Fits existing cut-outs for 6" (150 mm) edgewise switchboard pointer meters from:**

- Crompton
- G.E.
- Westinghouse
- Yokogawa
- and most others

Width: 43.7 mm to 48 mm (1.72" to 1.89")

Height: 143.4 mm to 149 mm (5.62" to 5.88")

Two bezel trim strips are provided with each adapter to finish off the edge of each individually mounted meter or the edge of each stack mounted array.

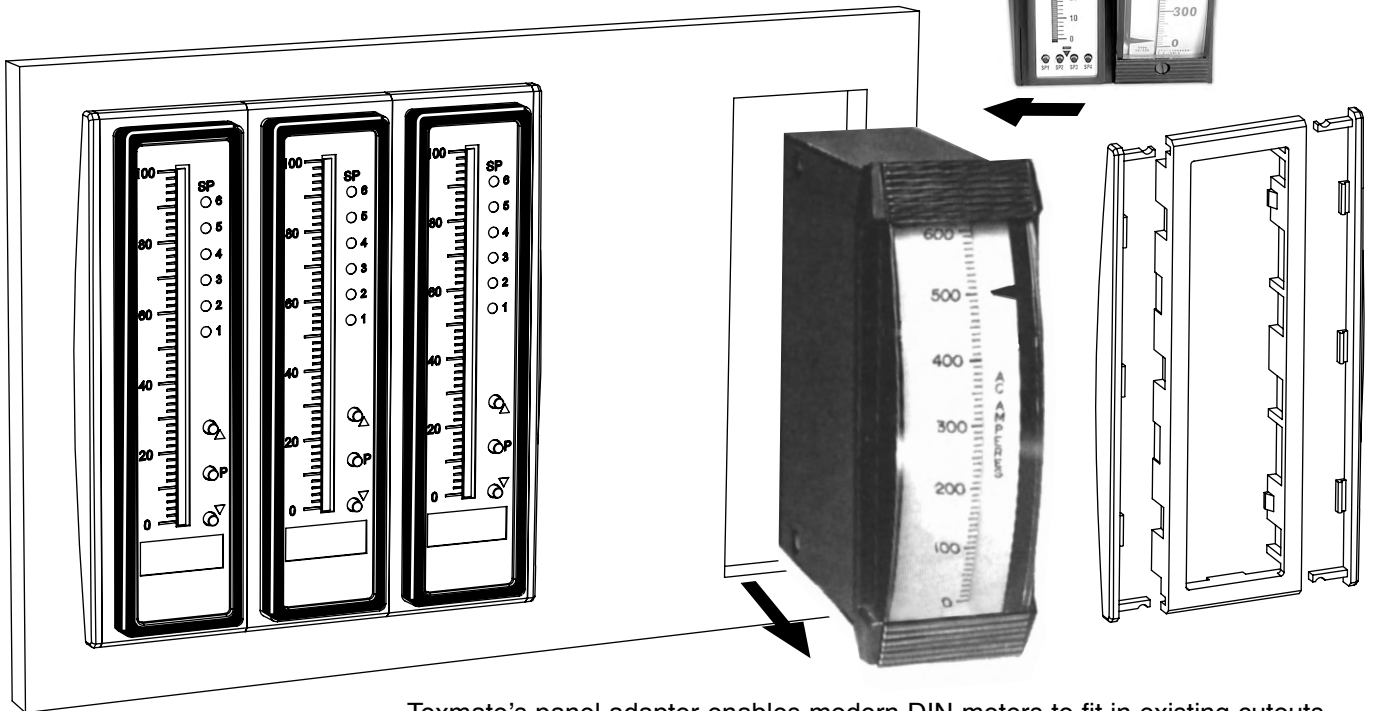
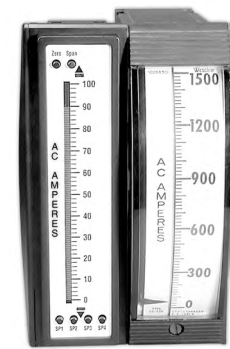
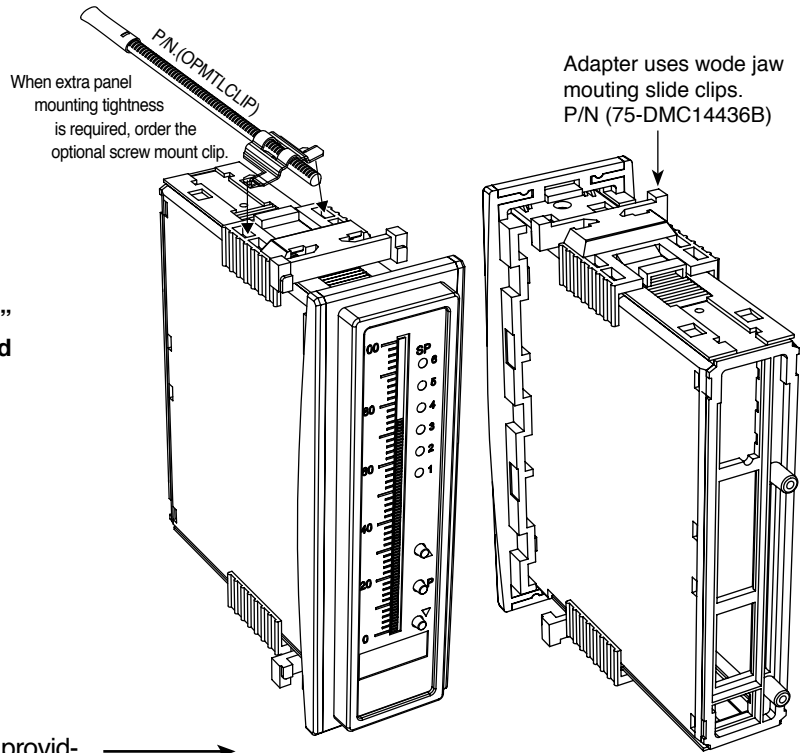

Texmate's panel adapter enables modern DIN meters to fit in existing cutouts individually or stacked when replacing old 6" edgewise mechanical pointer meters.

## Case Dimensions

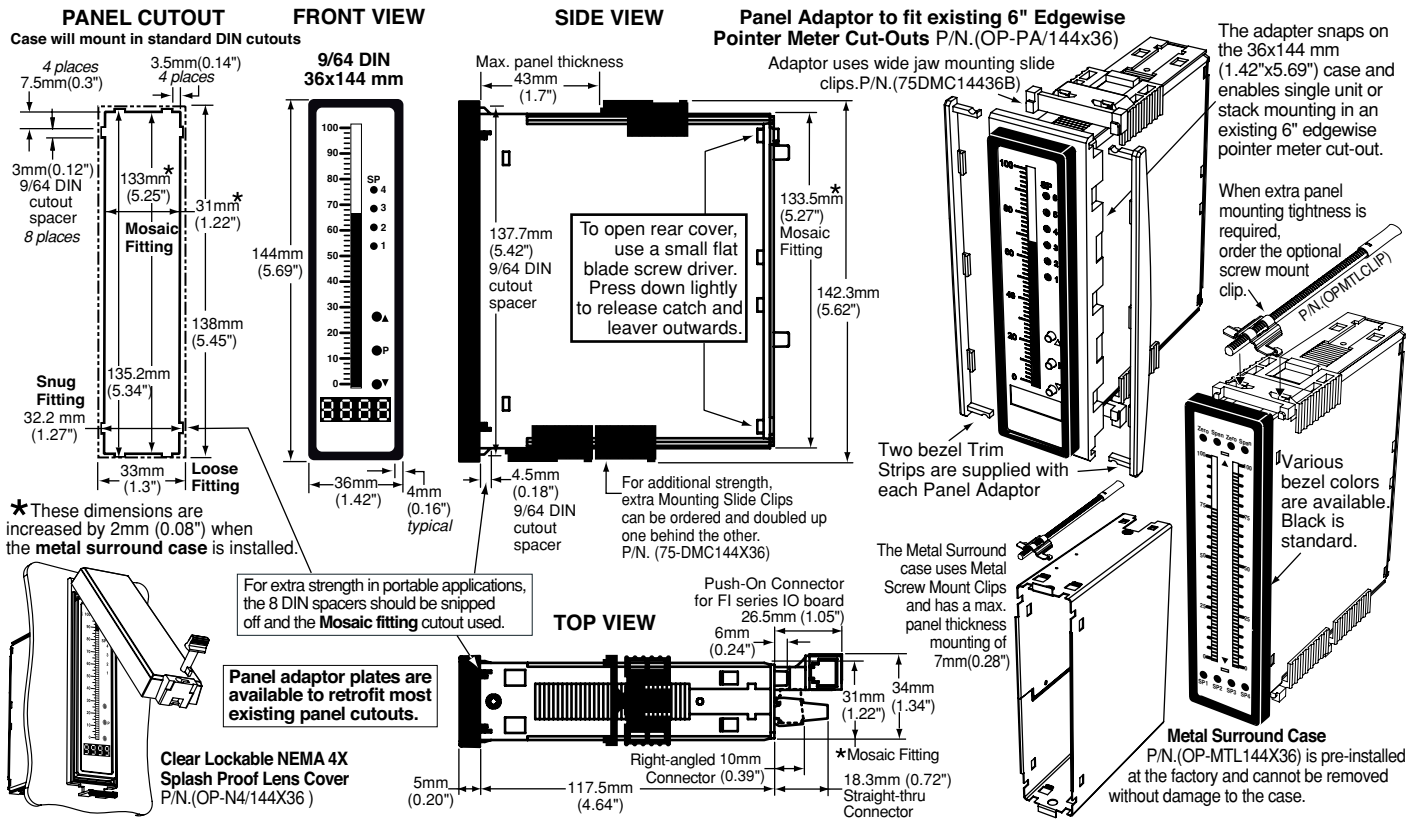

## Hinged Clear Lockable Polycarbonate NEMA 4X Splash Proof Cover

This rugged, impact resistant, clear lens cover is designed to be dust and water proof to NEMA 4 and IP65 standards. The lens cover consists of a base and cover with a cam hinge and key-lock device.

An O-ring, or neoprene gasket forms a seal between the base and the panel. When opened, a cam hinge prevents the cover from closing until pushed closed.

The cover has a tapered recess that, when closed, forms a capillary seal with a tapered ridge on the base. A capillary seal is created when capillary action causes a small amount of water to be drawn in between the two surfaces producing a water tight film around the sealing area.

For those applications, such as food processing, where fluid residues are unacceptable, apply a light coating of clear silicone grease, or other approved sealant to the mating groove to prevent any ingress of liquid and enable the cover to withstand steam cleaning.

Turning the key-lock tightens the cover to the base, ensuring seal integrity. A safety catch keeps the cover closed even when the key is turned to the open position and removed. The keyhole can also be used to attach a safety seal clip, preventing unauthorized opening.

9/64 DIN  
36x144 mm (1.42"x5.69")  
P/N: OP-N4/144X36

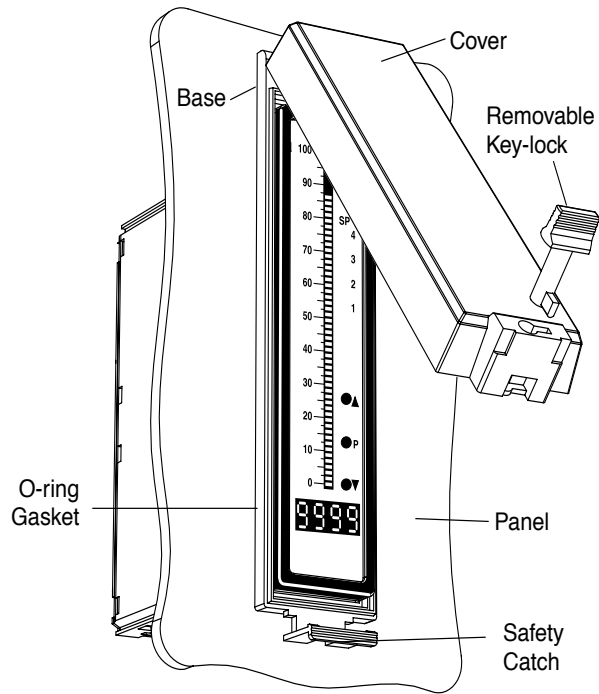

# Ordering Information

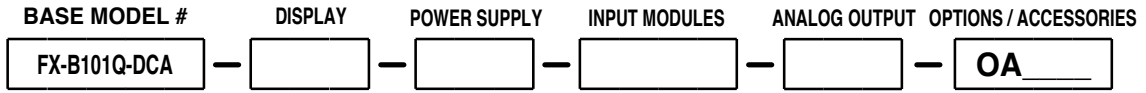

Add to the basic model number the order code suffix for each standard option required. The last suffix is to indicate how many different special options and or accessories that you may require to be included with this product.

**Ordering Example: FX-B101Q-DCA-VR-PS1-ID02-OA2, the 2 OA's are, ZR and a OP-PA/144X36**

**► BASE MODEL NUMBER**

**FX-B101Q-DCA** 144x36mm, Lynx, 101 Seg Bargraph DC Amps . .  
**FX-B101Q-DCA** 144x36mm, Lynx, 101 Seg Bargraph DC Volts. . .

**Standard Options for this Model Number**

Order Code Suffix	Description	List
-------------------	-------------	------

**► DISPLAY**

**VR** . . . 101 Segment Red LED Bargraph, Vertical . . . . .  
**HR** . . . 101 Segment Red LED Bargraph, Horizontal . . . . .  
**VG** . . . 101 Segment Green LED Bargraph, Vertical. . . . .  
**HG** . . . 101 Segment Green LED Bargraph, Horizontal . . . . .

**► POWER SUPPLY**

**PS1** . . . **85-265VAC/95-300VDC** . . . . .  
**PS2** . . . 14-48VAC/10-72VDC . . . . .

**► INPUT MODULES (Partial List. See www.texmate.com)**

Unless otherwise specified Texmate will ship all modules precalibrated with factory preselected ranges and/or scalings as shown in **BOLD** type.

**For FX-B101Q-DCA**  
**ID02** . . DC mV  $\pm 20\text{mV}$ ,  $\pm 50\text{mV}$ ,  **$\pm 100\text{mV}$** ,  $\pm 200\text{mV}$  w/24V Exc. . . . .

**For FX-B101Q-DCV**  
**ID01** . . DC Volts, **2V/20V/200V** w/24V Exc. . . . .  
**ID05** . . DC Volts, **2V/20V/200V** w/24V Exc. w/zero offset adjustable pot .

**► ANALOG OUTPUT**

**OIC** . . . Isolated 16 Bit Current Output, 4-20mA . . . . .  
**OIV** . . . Isolated 16 Bit Voltage Output, 0-10VDC . . . . .

**Special Options and Accessories**

Part Number	Description
-------------	-------------

**► SPECIAL OPTIONS (Specify Inputs or Outputs & Req. Reading)**

**ZR** . . . . . Calibrated Range Change to another Standard Range. . . . .  
**ZS-AOB** . . . . . Custom scaling of analog output for Q-series bargraphs. . . . .

**► ACCESSORIES (Specify Serial # for Custom Artwork Installation)**

**75-DMC14436B** . . Side Slide Brackets-Wide opening (2 pc) . . . . .  
**75-DMC144X36** . . Side Slide Brackets-stand. (2 pc) - extra set. . . . .  
**93-PLUG2P-DP** . . Extra Screw Terminal Conn., 2 Pin Power Plug . . . . .  
**93-PLUG2P-DR** . . Extra Screw Terminal Conn., 2 Pin Plug . . . . .  
**93-PLUG3P-DR** . . Extra Screw Terminal Conn., 3 Pin Plug . . . . .  
**93-PLUG4P-DR** . . Extra Screw Terminal Conn., 4 Pin Plug . . . . .  
**93-PLUG5P-DR** . . Extra Screw Terminal Conn., 5 Pin Plug . . . . .  
**DN.CAS144X36** . . Complete 144x36mm Case with Bezel . . . . .  
**75-DBZ144X36** . . Black Bezel for 144x36mm Case . . . . .  
**OP-MTL144X36** . . Metal Surround Case, includes screw mounting clips. . . . .  
**OP-MTLCLIP** . . . . . Screw Mounting Clips (2 pc) - to screw tighten slide brackets  
**OP-N4/144X36** . . . . . 144x36mm clear lockable front cover-NEMA 4X, splash proof.  
**OP-PA/144X36** . . . . . Panel Adapter for 144x36mm from 6 inch cutout . . . . .

For Custom Face Plates see page 10.

Prices subject to change without notice.

**WARRANTY**

Texmate warrants that its products are free from defects in material and workmanship under normal use and service for a period of one year from date of shipment. Texmate's obligations under this warranty are limited to replacement or repair, at its option, at its factory, of any of the products which shall, within the applicable period after shipment, be returned to Texmate's facility, transportation charges pre-paid, and which are, after examination, disclosed to the satisfaction of Texmate to be thus defective. The warranty shall not apply to any equipment which shall have been repaired or altered, except by Texmate, or which shall have been subjected to misuse, negligence, or accident. In no case shall Texmate's liability exceed the original purchase price. The aforementioned provisions do not extend the original warranty period of any product which has been either repaired or replaced by Texmate.

**USER'S RESPONSIBILITY**

We are pleased to offer suggestions on the use of our various products either by way of printed matter or through direct contact with our sales/application engineering staff. However, since we have no control over the use of our products once they are shipped, **NO WARRANTY WHETHER OF MERCHANTABILITY, FITNESS FOR PURPOSE, OR OTHERWISE** is made beyond the repair, replacement, or refund of purchase price at the sole discretion of Texmate. Users shall determine the suitability of the proDXct for the intended application before using, and the users assume all risk and liability whatsoever in connection therewith, regardless of any of our suggestions or statements as to application or construction. In no event shall Texmate's liability, in law or otherwise, be in excess of the purchase price of the product.

Texmate cannot assume responsibility for any circuitry described. No circuit patent or software licenses are implied. Texmate reserves the right to change circuitry, operating software, specifications, and prices without notice at any time.



1934 Kellogg Ave., Carlsbad, CA 92008  
 Tel: 1-760-598-9899 • USA 1-800-839-6283 • 1-800-TEXMATE  
 Fax: 1-760-598-9828 • Email: orders@texmate.com • Web: www.texmate.com

**FX-B101Q-DCA and FX-B01Q-DCV Technical Manual Copyright © 2019 Texmate Inc. All rights reserved. Published by: Texmate Inc. USA. Information in this Technical Manual is subject to change without notice due to correction or enhancement. The information described in this manual is proprietary to Texmate, Inc. and may not be copied, reproduced or transmitted, in whole or in part, in connection with the design, manufacture, or sale of apparatus, device or private label product without the express written consent of Texmate, Inc.**