



# DI-50D TIGER

## 5-DIGIT LED SMART DIGITAL METER



**A Powerful, Intelligent Digital Panel Meter for Monitoring, Measurement Control and Communication Applications**

### DESCRIPTION

The DI-50D TIGER meter is the most effective solution to a wide range of measurement, control and communication applications. With front panel push button commands, the user can setup the DI-50D TIGER to display a wide variety of input signals, including DC volts and current, AC volts and current (average and Trms), thermocouple, 2, 3, or 4 wire 100 ohm platinum RTDs, four or six wire Strain Gauge signals (load cells and pressure transducers), 4-20mA process signals and frequency. The DI-50D TIGER also has several dual input modules for process, pressure, T/C, VDC, RTD and resistance.

Input signals may be displayed as voltage or current, or scaled to read directly in engineering units (eg. PSI, GPM, FPS, RPM, lbs., degrees, etc.). Scaling in °F or °C is programmable from the front panel. With user selectable 3 or 16 readings per second, the DI-50D TIGER provides fast control response, true peak readings and an analog output signal that tracks the input signal.

An isolated 5 or 10VDC excitation is available to power pressure transducers and load cells, eliminating the need for an external power supply. 24VDC excitation is available on certain input signal conditioning modules to power process transmitters.

Options include from one to four high isolation relays to implement alarm setpoints programmed by the user. These outputs can be set to operate above or below the setpoint and in a latched or non-latching mode. Time delays and hysteresis of the output are digitally settable. Optional isolated analog outputs of 0-10VDC and 0-20mA (4-20mA) are available to drive chart recorders, remote displays or for retransmission to a central control room. The isolated analog output is scalable from the front panel.

The third simultaneous output option available is isolated RS-232C or RS-485 which enables the DI-50D TIGER meter to communicate with PLC's or personal computers. Baud rates are software selectable from 200 to 19200. Multiple meter software application software is available to facilitate meter setup.

### SPECIFICATIONS

<b>Input Configuration:</b>	.....25 single and dual input modules
<b>Output Options:</b>	
<i>Relay</i>	.....Two 10A form C and/or two 5A form A
<i>Analog</i>	.....Isolated 0-20mA (4-20mA) or 0-10VDC, scalable by user
<i>Communication</i>	.....Isolated RS232C or RS485
<b>Display Range:</b>	.....-19999 to +32766 or -19990 to +99990 (dummy zero selected)
<b>Input Impedance:</b>	.....1 Meg Ohm for DCV (Depending on input module selected)
<b>Internal Resolution:</b>	.....16 bit
<b>Common Mode Rejection:</b>	.....> 35dB at 50Hz
<b>Conversion Mode:</b>	.....Dual slope; bipolar
<b>Accuracy:</b>	.....±(0.05% of reading + 1 digit)
<b>Conversions per sec:</b>	.....Typically 3, programmable to 16
<b>Temp. Coefficient:</b>	.....< 80ppm/°C
<b>Display:</b>	.....7 segment, 0.56" high LEDs, 5 digit, red or green
<b>Polarity:</b>	.....Auto
<b>Decimal Point:</b>	.....User programmable
<b>Annunciators:</b>	.....Front panel; one annunciator per alarm. Annunciators may also be programmed to display trend.
<b>Overload Indication:</b>	.....Indication "-----"
<b>Case Dimensions:</b>	.....1/8 DIN (96x48x117mm) not including connectors
<b>Panel Cutout:</b>	.....45x92mm
<b>Case Material:</b>	.....Metal sheathed ruggedized plastic
<b>Power Requirements:</b>	.....85-265VAC/95-370VDC or optionally 18-36VAC/9-60VDC, Isolated

### ORDERING INFORMATION

Order Part No.

- **DI-50D base unit**, standard software, 5 digit red LED display, universal automatic 85-285 VAC or 95 to 370 VDC power supply, plug-in screw terminal blocks, and documentation (Requires input module. See below).....**DI-50D-DR-PS1**
- **Display Option:**  
High efficiency green LED display .....**DI-GREEN5**
- **Power Supply Option:**  
Low voltage 18-36VAC or 9-60VDC Isolated Power Supply .....**DI-50D-DR-PS2**
- **Metal sheath option** for polycarbonate case .....**OP-MTL 96x48**
- **NEMA 4 lens cover** .....**OP-N4X/96x48**
- **Input Options:** See page 13-15
- **Output Options:** See page 12

# FRONT PANEL FUNCTIONS

## DISPLAY WITH FACEPLATE AND BEZEL

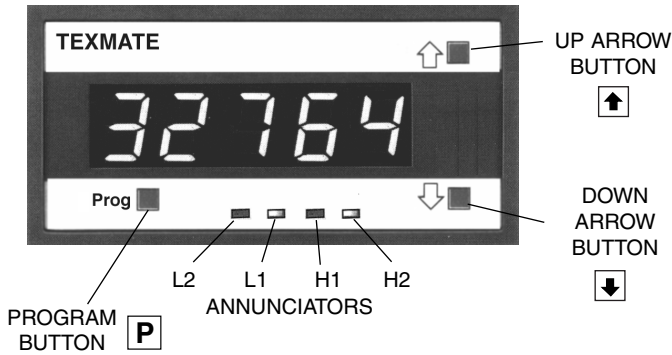

**PROGRAM BUTTON:** This button is used to move from one program step to the next. When used simultaneously with the UP ARROW button, it initiates the Programming Mode. When used simultaneously with the DOWN ARROW button, it initiates the Setpoint Program.

**UP ARROW BUTTON:** Increases the value of the displayed parameter.

**DOWN ARROW BUTTON:** Decreases the value of the displayed parameter.

## DISPLAY BOARD WITHOUT FACEPLATE

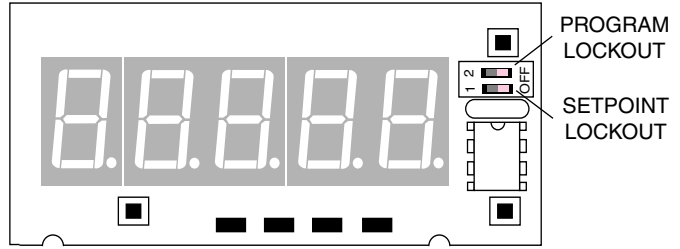

**ANNUNCIATORS:** May be programmed to indicate the setpoint status. They are labeled L2, L1, H1, H2.

**PROGRAM LOCKOUT SWITCH:** Once the program has been entered, this switch will not allow any changes to be made except for the setpoints. If programming is attempted, the DI-50D TIGER will display 'LOC'. Parameters may still be viewed but not changed.

**SETPOINT LOCKOUT:** Once the setpoint values have been entered this switch will not allow changes to be made except for the program. If setpoint programming is attempted, the DI-50D will display 'LOC'. Parameters may still be viewed but not changed.

# BASIC METER OPERATION

## STANDARD PROGRAMMING

The resident software in the DI-50D TIGER has been designed for maximum user flexibility while maintaining an intelligible programming process. This 'intuitive' software, unique to the Texmate DI-50D TIGER, allows quick understanding of the meter's capabilities while allowing the user to be in control.

The software set up can be accomplished via the three front panel buttons (Prog./Up arrow/Down arrow.) To begin, these three buttons allow the user access to input scaling (MX+B), baud rate selection, setting of an address and display brightness. These first selections are then followed by the programming of a series of four 3-digit codes. Each digit within a single code represents a specific function of the DI-50D TIGER. The user can customize the meter to their exact needs. If a function requires change after the initial set up, all previous selections can be ignored (skipped) and only the specific code affecting the function in question needs to be changed. This unique code structure makes software modifications fast and easy. Texmate has Technical Staff on call to assist you in this process should the need arise.

## MeterBOSS™ SOFTWARE

As an option, Texmate offers MeterBOSS software which can be accessed through the serial port from your personal computer. This is in addition to our standard DI-50D TIGER meter package and allows the user to display and modify data directly on the PC screen. MeterBOSS software is explained fully on page 9 of this bulletin.

## EXAMPLE PROGRAMMING SYMBOLS

Symbol	Explanation
	When a button is shown, press and release it to go onto the next step in the direction indicated by the arrow.
	When two buttons are shown side by side and enclosed by a dotted line, they must be pressed simultaneously then released to go onto the next programming step. For example, the symbols shown at left indicate the user is to press the Program button and the Up Arrow button simultaneously together.
	The display toggles (flashes) between the name for the function and the value.
	When these buttons are shown together, the display value can be increased by pressing the Up Arrow button or decreased by pressing the Down Arrow button. <i>Note: When pressed for a few seconds, the rate of change increases.</i>
	If an X appears through a digit, it means to that any number displayed in that digit is not relevant to the function being explained.



# PROGRAMMING CODE DEFINITIONS

*NOTE: Standard factory default settings are shown in **bold**.*

8 8 8 8  
C 0 0 1

8 8 8 8

## FRONT PANEL ANNUNCIATORS

- Blank Always OFF
- 1 ON when alarms OFF
- 2 **ON when alarms ON**
- 3 Indicate TREND

## DECIMAL POINT PLACEMENT

- 0 **None**
- 1 None
- 2 Rear DP Select  
X•XXXX/XX•XXX/XXX•XX/XXXX•X
- 3 Rear DP Select  
XX•XXX/XXX•XX/XXXX•X/XXXX
- 4 X•XXXX
- 5 XX•XXX
- 6 XXX•XX
- 7 XXXX•X

## DISPLAY ROUNDING

- 0 **None**
- 1 By 2's
- 2 By 5's
- 3 By 10's
- 4 LSD dummy zero (MSD MAX 9)
- 5 By 20's (MSD MAX 9)
- 6 By 50's (MSD MAX 9)
- 7 By 100's (MSD MAX 9)

8 8 8 8  
C 0 0 2

8 8 8 8

## DISPLAY FLASHING

- Blank **None**
- 1 For LoL1, LoL2 violation
- 2 For HiL1, HiL2 violation
- 3 For any alarm violations

## PEAK/VALLEY OR RELAY ACTIVATION

- 0 No relays
- 1 Display VALLEY reading
- 2 Display PEAK reading
- 3 Not used
- 4 HiL1/HiL2 ON below setpoint  
LoL1/LoL2 ON below setpoint
- 5 HiL1/HiL2 ON above setpoint  
LoL1/LoL2 ON above setpoint
- 6 **HiL1/HiL2 ON above setpoint  
LoL1/LoL2 ON below setpoint**
- 7 HiL1/HiL2 ON above setpoint  
LoL1/LoL2 ON above setpoint

## SPECIAL RELAY FUNCTION

- 0 **None**
- 1 Hysteresis in Counts
- 2 Time Delay in Seconds
- 3 Latching
- 4 Hysteresis in counts with Latching
- 5 Time Delay in seconds with Latching
- 6 Not used
- 7 Not used

8 8 8 8  
C 0 0 3

8 8 8 8

## ANALOG OUTPUT

- Blank **Direct display of input**
- 1 Cosine of input
- 2 Front panel auto-calibration
- 3 Front panel auto-tare

## ANALOG OUTPUT

- 0 Remote control of Analog Output
- 1 **Analog Output Display Data**
- 2 Analog Output-Range Set
- 3 Analog Output-Calibrate
- 4 Analog Output-Raw Data
- 5 Not Used
- 6 Not Used
- 7 Not Used

## AVERAGING

- 0 **None**
- 1 Over 2 samples
- 2 Over 4 samples
- 3 Over 8 samples
- 4 Over 16 samples
- 5 Over 32 samples
- 6 Over 64 samples
- 7 Smart filtering

8 8 8 8  
C 0 0 4

8 8 8 8

- Blank Conversion Rate 16/sec
- 1 Counter or frequency
- 2 **Conversion rate 3/sec**
- 3 Period measurement

- 0 **Voltage, Current, or Frequency**
- 1 Temperature or Resistance
  - 2 Inverse Voltage, Current or Frequency
  - 3 Inverse Temperature or Resistance
  - 4 Counter
  - 5 Display Linearized Input Signal
  - 6 Program Linearization Points
  - 7 Remote display via serial communications

When XXX0X, XXX2X, \_\_\_\_\_ or XXX4X, then:

- 0 **Single Input Voltage, Current**
- 1 Remote HiL1 or 2KHz
  - 2 Dual Channel V1
  - 3 Dual Channel V2 or 20KHz
  - 4 Dual Channel V1 - V2
  - 5 Dual Channel  
(V1 x 20000)/V2 or 200KHz
  - 6 Dual Channel V1 + V2
  - 7 Dual Channel  
(V1 x V2)/10000

When XXX1X or XXX3X, then:

- 0 Thermocouple type R
- 1 Thermocouple type J
- 2 Thermocouple type T
- 3 Thermocouple type K
- 4 Resistance 2 or 4 wire
- 5 RTD Pt 100 2 or 4 wire
- 6 Resistance 3 wire
- 7 RTD Pt 100 3 wire

# VIEWING, VERIFYING AND ADJUSTING SETPOINTS AND PEAK/VALLEY READINGS

## TO VIEW AND VERIFY SETPOINTS AND PEAK/VALLEY READINGS

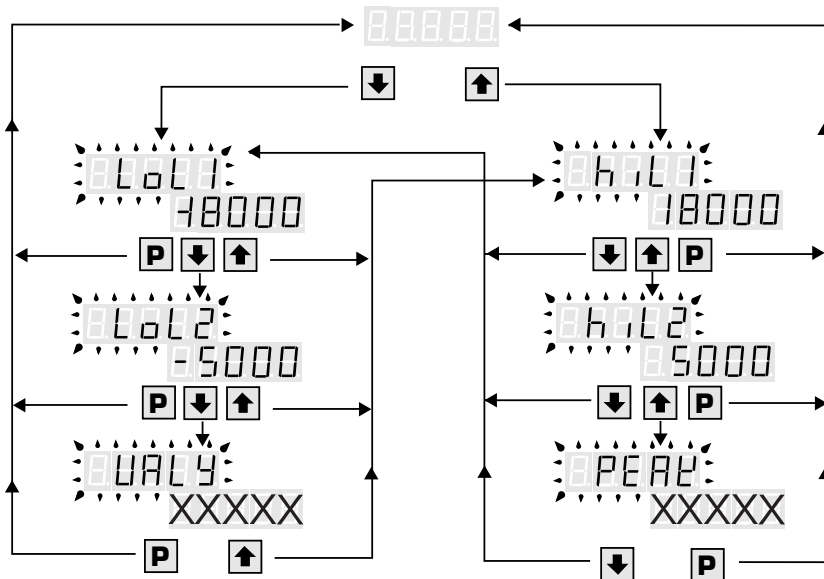

### EXPLANATION

To verify the SETPOINTS and PEAK/VALLEY readings while under normal operation:

1. To verify the **hiL1**, press and release the “”.
2. To verify the **hiL2**, press and release the “”.
3. To verify the **PEAK**, press and release the “”.
4. To verify the **LoL1**, press and release the “”.
5. To verify the **LoL2**, press and release the “”.
6. To verify the **VALLEY**, press and release the “”.

**NOTE:** If the DI-50D is ordered without setpoints, LoL1 and hiL1 will appear with default values, but will be inactive. If the DI-50D is ordered with two setpoints, LoL2 and hiL2 will appear with default values, but will be inactive. PEAK/VALLEY readings are present with all versions.

**NOTE:** To reset the PEAK or VALLEY readings, press and release the and simultaneously when PEAK or VALLEY is displayed.

## TO SET AND ADJUST SETPOINT VALUES

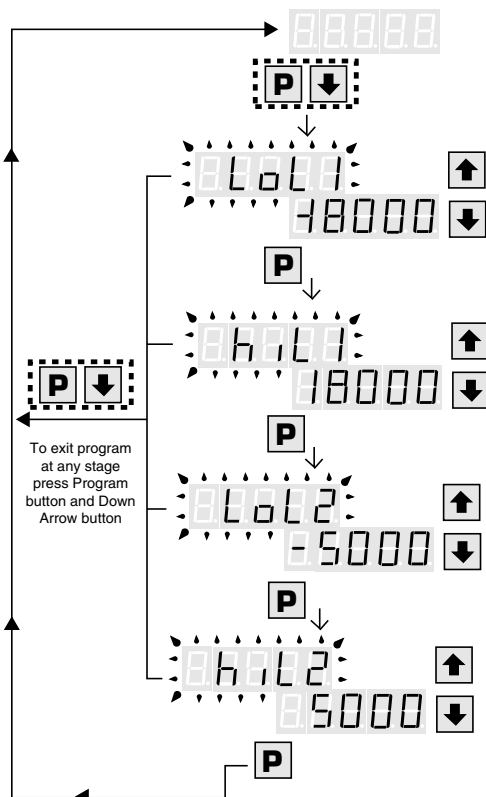

### EXPLANATION

**STEP A** Press “Prog” and “” simultaneously

DI-50D Displays toggle of [LoL1] and [XXXXX] (-18000 is the default value)

**STEP B** Using the and , adjust display to the desired value for LoL1 setpoint.

Press “Prog”.

DI-50D Displays toggle of [hiL1] and [XXXXX] (18000 is the default value)

**STEP C** Using the and , adjust display to the desired value for hiL1 setpoint.

Press “Prog”.

DI-50D Displays toggle of [LoL2] and [XXXXX] (-5000 is the default value)

**STEP D** Using the and , adjust display to the desired value for the LoL2 setpoint.

Press “Prog”.

DI-50D Displays toggle of [hiL2] and [XXXXX] (5000 is the default value)

**STEP E** Using the and , adjust display to the desired value for hiL2 setpoint.

Press “Prog”.

DI-50D Displays Operational Display

# SET AND ADJUST HYSTERESIS AND HYSTERESIS WITH LATCHING

## HYSTERESIS



Start at Code 2 (see pages 4 and 5)



Change existing number in Digit 3 to a 1 for Hysteresis or to a 4 for Hysteresis with Latching



Enter the desired number of counts (up to 127 counts for Hysteresis.)

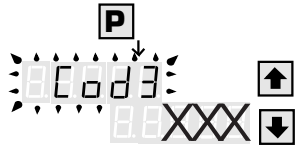

Press Prog. button to move through Code 3

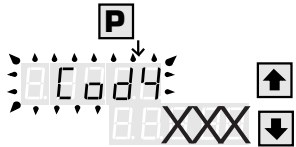

Press Prog. button to move through Code 4 and press Prog. again to return to operational display.

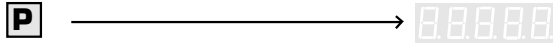

## HYSTERESIS WITH LATCHING



Start at Code 2 (see pages 4 and 5)



Change existing number in Digit 3 to a 1 for Hysteresis or to a 4 for Hysteresis with Latching



Enter the desired number of counts (up to 127 counts for Hysteresis.)

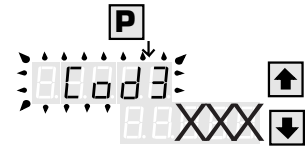

Press Prog. button to move through Code 3

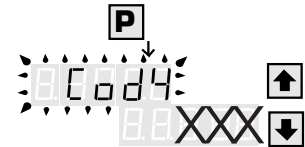

Press Prog. button to move through Code 4 and press Prog. again to return to operational display.

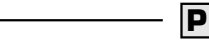

# SET AND ADJUST TIME DELAY AND TIME DELAY WITH LATCHING

## TIME DELAY



Start at Code 2 (see pages 4 and 5)



Change existing number in Digit 3 to a 2 for Time Delay or to a 5 for Time Delay with Latching



Enter the desired number of counts (up to 127 counts for Time Delay.)



Press Prog. button to move through Code 3



Press Prog. button to move through Code 4 and press Prog. again to return to operational display.

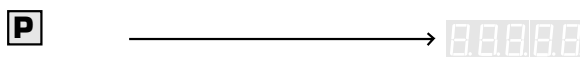

## TIME DELAY WITH LATCHING



Start at Code 2 (see pages 4 and 5)



Change existing number in Digit 3 to a 2 for Time Delay or to a 5 for Time Delay with Latching



Enter the desired number of counts (up to 127 counts for Time Delay.)



Press Prog. button to move through Code 3



Press Prog. button to move through Code 4 and press Prog. again to return to operational display.

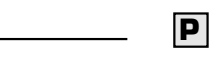

# SET UP AND CALIBRATION OF ANALOG OUTPUT

## Procedure for Setting Up & Calibrating Analog Output



**STEP A** Starting at Code 3 (see pages 4 and 5), set 2nd digit to a [x2x] by pressing the up arrow (Setting of analog output range)

Press "Prog".

DI-50D displays toggle of [ZEro] and [0]



P



**STEP B** Using the and , adjust display to the desired reading for a zero output.

Press "Prog".

DI-50D displays toggle of [F. S.] and [10000]

P



**STEP C** Using the and , adjust display to the desired reading for a Full Scale output.

Press "Prog".

DI-50D Displays toggle of [Cod3] and [x2x]

P



**STEP D** Connect a multimeter to the analog output pins 16 and 17. Adjust Code 3 Digit 2 to a [x3x] (Calibrating of the analog output)

Press "Prog".

DI-50D Displays toggle of [CAL\_L] and a number. The exact number displayed is irrelevant, as it is proportional to the internal gain.



P



**STEP E** Using the and , adjust the analog output, as measured by the multimeter to read exactly 0V or 0mA (depending on whether the volt or current option has been selected on the output board)

Press "Prog".

DI-50D Displays toggle of [CAL\_h] and a number. The exact number displayed is irrelevant, as it is proportional to the internal offsets.

P

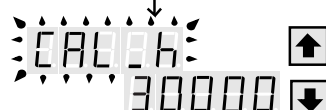

**STEP F** Using the and , adjust the analog output, as measured by the multimeter to read exactly 10 V or 20 mA (depending on whether the voltage or current option has been selected on the output board)

Press "Prog".

DI-50D Displays toggle of [Cod3] and [X3X]

P



**STEP G** Adjust Code 3 Digit 2 to a [x1x].

Press "Prog" button to move to Code 4, then press Prog. button once again to return to operational display.

P



P







# 10 POINT LINEARIZATION



Prior to the actual programming, Texmate recommends that the user define the 10 linearization points. To program the DI-50D to linearize a signal, the procedure is as follows:

Step 1. Press "Prog" and  simultaneously.  
DI-50D Displays toggle of [PCA\_] and [HCA -]

**Note** [HCA ] = Hardware Calibration. An external calibration device is required.



## Hardware Calibration Procedure.



Step 2. Press . This is [HCA ].  
DI-50D Displays toggle of [ZEro] and [0]. If the number displayed is not 0, use  and  to make display read 0.



Step 3. Apply to the Input Terminals, the minimum value of the Input signal . Press "Prog".  
DI-50D Displays toggle of [SPAn] and [10000] If the number displayed is not 10000, use  or  to make display read 10000.



Step 4. Apply to the Input Terminals, the maximum value of the Input signal. Press "Prog".  
DI-50D Displays [10000]



Step 5. Set Code 4 Digit 2 to a [x6x]. Press "Prog"  
DI-50D Displays toggle of [P 00] and [0]



Step 6. Using the  and , adjust display to the desired reading when the minimum input is applied to the DI-50D. Press "Prog".  
DI-50D Displays toggle of [P 10] and [1000]



Step 7. Using the  and , adjust display to the desired reading when 10% of the input is applied to the DI-50D. Press "Prog".  
DI-50D Displays toggle of [P 20] and [2000]



Step 8. Using the  and , adjust display to the desired reading when 20% of the input is applied to the DI-50D. Press "Prog".  
DI-50D Displays toggle of [P 30] and [3000]



Step 9. Using the  and , adjust display to the desired reading when 30% of the input is applied to the DI-50D. Press "Prog".  
DI-50D Displays toggle of [P 40] and [4000]



Step 10. Using the  and , adjust display to the desired reading when 40% of the input is applied to the DI-50D. Press "Prog".  
DI-50D Displays toggle of [P 50] and [5000]



Step 11. Using the  and , adjust display to the desired reading when 50% of the input is applied to the DI-50D. Press "Prog".  
DI-50D Displays toggle of [P 60] and [6000]

Step 12. Using the  and , adjust display to the desired reading when 60% of the input is applied to the DI-50D. Press "Prog".  
DI-50D Displays toggle of [P 70] and [7000]

Step 13. Using the  and , adjust display to the desired reading when 70% of the input is applied to the DI-50D. Press "Prog".  
DI-50D Displays toggle of [P 80] and [8000]

Step 14. Using the  and , adjust display to the desired reading when 80% of the input is applied to the DI-50D. Press "Prog".  
DI-50D Displays toggle of [P 90] and [9000]

Step 15. Using the  and , adjust display to the desired reading when 90% of the input is applied to the DI-50D. Press "Prog".  
DI-50D Displays toggle of [P100] and [10000]

Step 16. Using the  and , adjust display to the desired reading when the maximum input is applied to the DI-50D. Press "Prog".  
DI-50D Displays toggle of [cod4] and [x6x]  
Adjust Code 4 Digit 2 to a [x5x]. Press "Prog".  
until the DI-50D returns to the operational display.

## TARE FUNCTION

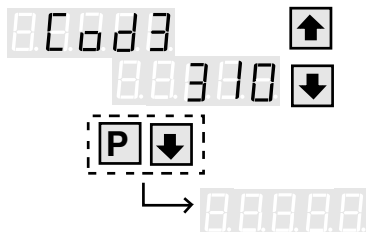

**STEP A** Enter into the [PCA\_] Program Mode by pressing "Prog" and the  simultaneously. DI-50D Displays toggle of [HCA ] and [PCA\_]

**STEP B** Press the . You are now in the [PCA\_] Programming Mode.

**STEP C** Continue to press the "Prog" button until [cod3] appears.

**STEP D** Using the  or , adjust the first digit to a [3xx].

**STEP E** Press "Prog" twice to return to the Operational Display  
DI-50D Displays [INPUT]

A decimal point to the extreme right of the display will be illuminated when the "Prog" is pressed. This is the indication that the Tare Function is enabled. The "Prog" is now the Tare button. Whenever the "Prog" is depressed, the DI-50D will make the current display zero.

To reset the Tare Function, press the  and  simultaneously. The Tare Function will be disabled and the display will return to normal.



# METERBOSS

## Optional Multiple Meter Software

MeterBOSS gathers data from Texmate panel meters that have serial ports and incorporates their readings into display, alarm, logging and Logic Sequencer functions. MeterBOSS is a full-featured, user-friendly software program for your IBM personal computer (PC), PC compatible or laptop. No computer plug-in cards are required, so MeterBOSS is ideal for laptops.

MeterBOSS is designed to be used without a reference manual. Powerful automatic Hypertext help messages guide you through MeterBOSS' simple straight forward operation. As new meters are designed by Texmate, MeterBOSS' scrolling screens and pop-up data windows will allow additions to be incorporated without modifying MeterBOSS' familiar display format.

### Applications

- Experimental data taking (laboratory)
- Prototype (test rigs)
- Quality checking (test stands)
- Product performance documentation (logging)
- Statistical quality control (data acquisition)
- Regulatory compliance (data acquisition and logging)
- Apparatus Sequencing (test stands)
- Monitoring remote meters (remote displays)

### MeterBOSS Capabilities:

Display 1, 4, 9, or 16 instruments per screen as digital meters

Display 4, 9, or 16 instruments per screen as bargraphs

Set multiple alarms for each meter which will appear as flags on the meter face or bargraph and/or operate input/output devices

User composed messages appear on screen when the associated alarm is tripped

Display total number of alarms presently tripped

All alarm messages presently active are viewable on a single screen

User selectable data logging at specific intervals, on alarm tripp or manually on mouse click

Graphical display of data being logged or play back of previously logged data

Extensive Hypertext help messages virtually eliminates the need for a manual

Setup by either keyboard or mouse (mouse highly recommended)

All instruments and input/output devices presently supported by MeterBOSS are selectable by mouse click from a scrolling list

All configured instrument options explained on and selected from a specially designed instrument setup screen

Texmate instruments with RS-232 interface supported directly (RS-422 and RS485 supported through adapters)

Concurrently operates instruments and I/O devices having mixed baud rates and communication protocols

Communication integrity monitored and faults logged to a file for analysis

Automatic communication port configuring, including location and avoiding the mouse port

Any MeterBOSS configuration can be saved for future use

Automatically restarts itself from activity where program stopped

Operates outputs from instrument values or internal Logic Sequencer

Derived meter capability through mathematical relationships to other meters

System cycle time continuously calculated and display

Logic Sequencer steps on time, instrument limits and logic or all three

### MeterBOSS Contents

1. MeterBOSS software on a 3 1/2" diskette in a sealed software license envelope (5 1/4" if requested with order)
2. MeterBOSS instruction manual
3. User registration card
4. Documents explaining any User Referral Reward or Incentive Programs that may be in effect at time of your purchase.

### Hardware Requirements

MeterBOSS requires an IBM PC, XT or AT or 100% compatible with 640 Kb minimum of RAM, hard disk, 3 1/2" (or 5 1/4" diskette if requested at the time of order) drive and EGA/VGA video monitor, and MS-DOS 3.0 higher. A mouse is highly recommended.

If more than a single instrument is to be operated by MeterBOSS, your computer must be equipped with multiple serial ports, or an external port multiplexer such as Texmate's PortMUX. (Call for more information.)

MeterBOSS can operate most serial port (RS-232) equipped instruments directly through your computer's serial port (RS-422 and RS-485 supported through inexpensive industry standard port adapters.) A list of all meters supported by a specific version of MeterBOSS appears in a pop-up window on the MeterBOSS Hardware Selection Screen. The ability to operate additional instruments is being incorporated daily into the MeterBOSS program. Contact Texmate for an up-to-date list of instruments presently supported.

### Estimated MeterBOSS Setup Time

1	Personalize original MeterBOSS diskette and send in registration card	1 min
2	Install MeterBOSS on your computer	2 min
3	Pick the measurement instruments you plan to use from MeterBOSS's menu	2 min
4	Select the measuring instrument options you need to use for your job	8 min
5	Name the parameters and unit of measure for the MeterBOSS screen Display Meters	3 min
6	Relate (tie together) the Display Meters with the measuring instruments and set scale factors, tare values, if needed	3 min.
7	Set alarm values (if needed) and compose alarm messages to be displayed with alarms are violated (tripped)	1.5 min
Total average setup time		20.5 min

# FUNCTIONAL DIAGRAM

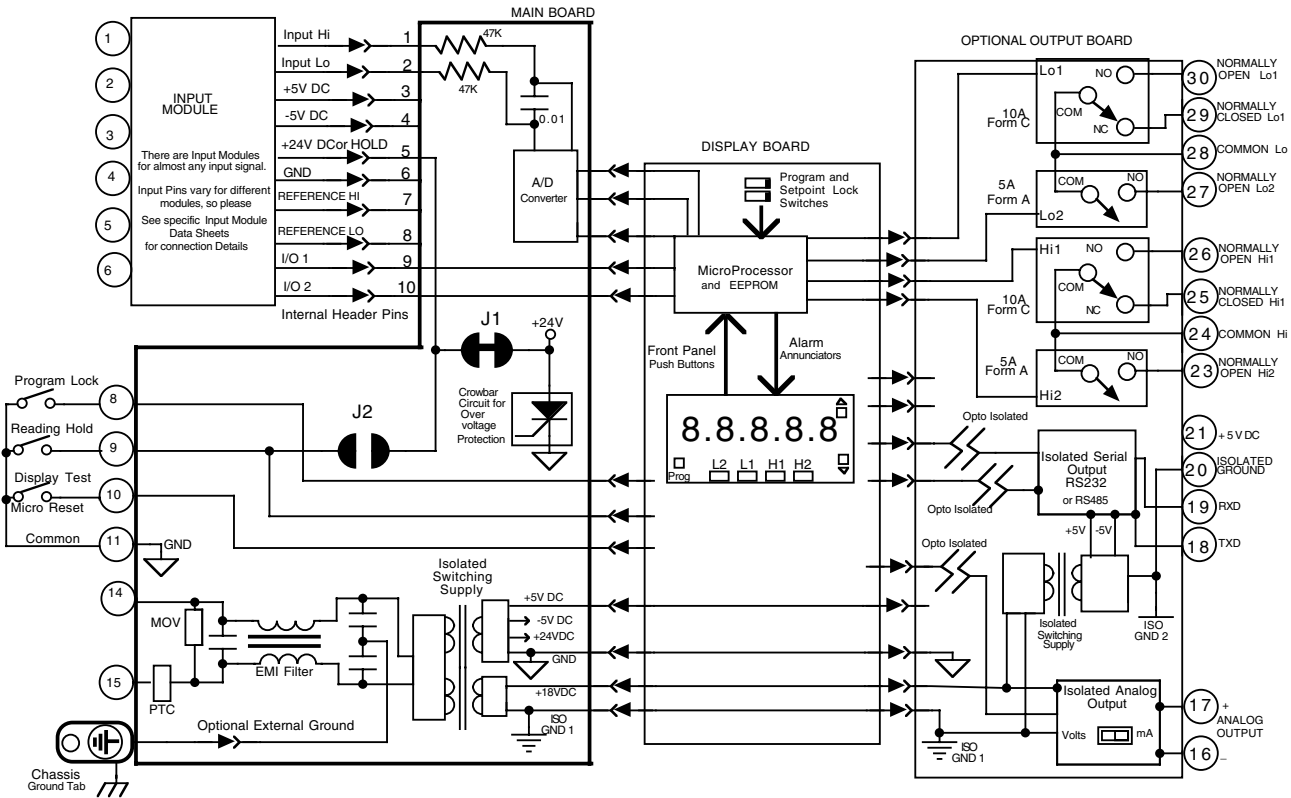

## CONNECTOR PINOUTS

The Texmate Model DI-50D TIGER comes standard with screw terminal block connections. The serial output (RS232 or RS485) is accessed via an RJ-11 phone connector, or optionally a screw terminal block is available for serial communication if required.

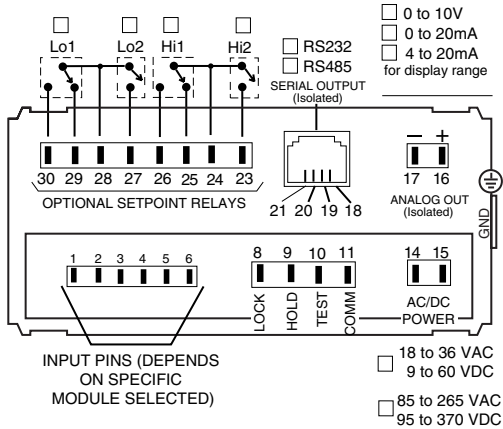

## POWER SUPPLY

The standard power supply for the DI-50D TIGER is a high efficiency, switching, pulse width modulated power source. The effective operating range is 85 to 265VAC and 95 to 370VDC. The DI-50D TIGER will accept either ACV or DCV without any internal hardware or wiring modification to the base unit.

The optional low level power supply for the DI-50D TIGER is designed for operation from 18 to 36VAC and 9 to 60VDC.

## PIN DESCRIPTIONS

**Pins 1 to 6 - Input Module.** See the individual data sheet of the input module selected, for detailed information on the pins. Usually Pin 1 is the Signal Input High pin and Pin 3 is the Signal Input Low pin.

**Pin 8 - Program Lock.** By connecting this pin to the Common Pin 11, the set up program is locked out. The programmed meter parameters may be viewed but not changed, when the meter is in the "locked out" mode.

**Pin 9 - Hold Reading.** When this pin is connected to the Common Pin 11, the reading displayed will be frozen. A/D conversions will continue however, and as soon as Pin 9 is disconnected from Pin 11 the updated reading will be instantly displayed.

**Pin 10 - Display Test.** When this pin is momentarily connected to the Common Pin 11, all segments of the display light up and five 8's are displayed for 3 seconds. This detects any missing segments in the display. The microprocessor is also reset during the 3 seconds.

**Pin 11 - Common.** To activate, Hold, Test, Lockout or Reset, the respective pins have to be connected to this Common Pin.

**Pin 14 & 15 - AC/DC Power Input.** These pins are the power pins of the meter. The standard DI-50D has a universal power supply that works from 85V to 265VAC, 50/60/400Hz or 95 to 370VDC. An optional low voltage power supply that works from 9-60VDC/18-36VAC Isolated is also available.

**Chassis Ground Tab -** This grounding tab is supplied for chassis grounding.

# COMPONENT LAYOUT

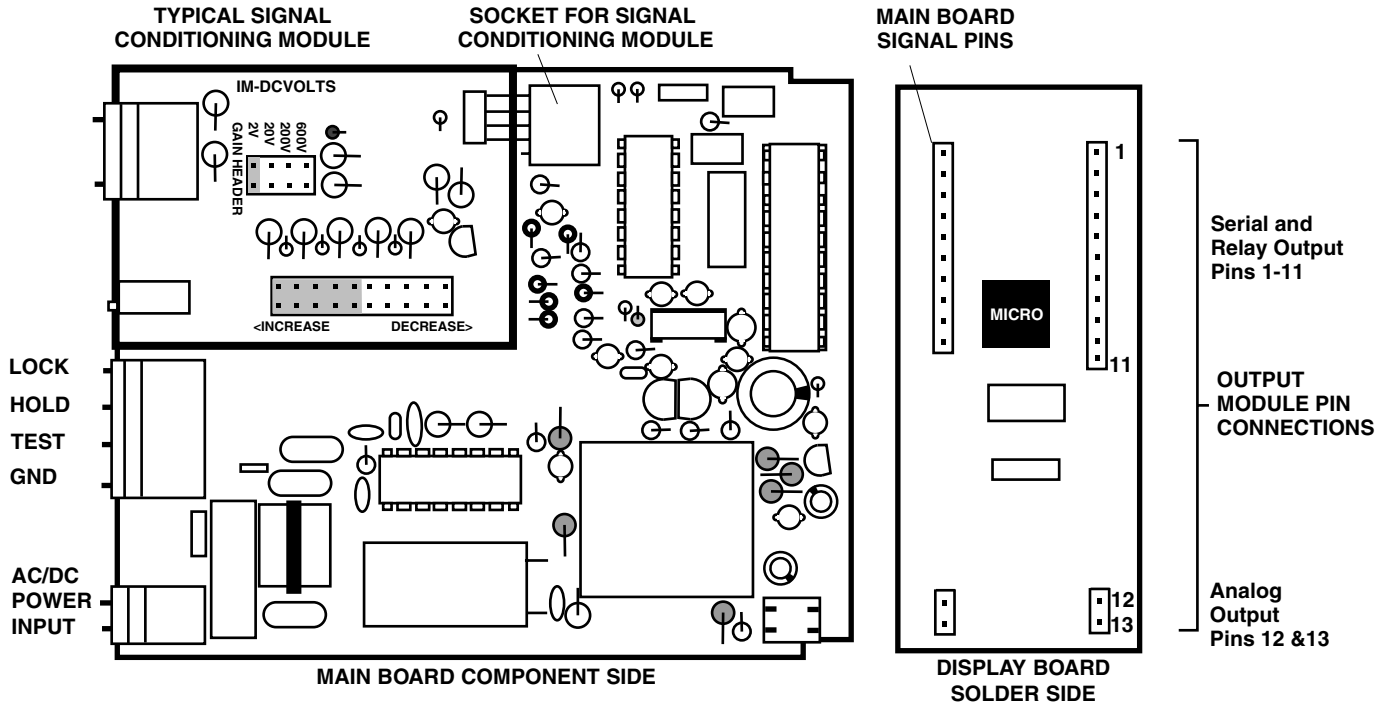

## MAIN BOARD TO SIGNAL CONDITIONER INTERCONNECTION

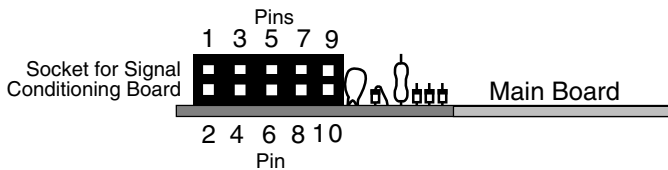

- Pin 1 - A/D Converter Input HI.** Maximum  $\pm 2\text{VDC}$ .
- Pin 2 - A/D Converter Input LO.** Maximum  $\pm 2\text{VDC}$ .
- Pin 3 - +5VDC @ 30mA.** To power the input signal conditioner.
- Pin 4 - -5VDC @ 30mA Power.** To power the input signal conditioner.
- Pin 5 - +24VDC @ 25mA.** If pad J is opened, Pin 5 will become HOLD.
- Pin 6 - Ground** for Input Signal Conditioner
- Pin 7 - Reference voltage** positive (+)
- Pin 8 - Reference voltage** negative (-)
- Pin 9 - Input/Output 1** for microprocessor
- Pin 10 - Input/Output 2** for microprocessor

## SIGNAL CONDITIONING MODULE OPTIONS

A signal conditioning module is required to operate the DI-50D meter. A separate ordering guide and an individual, specific data sheet is available for each module. Some of the input options include DC Volts, DC millivolts, DC milliamps, AC Volts, AC millivolts, AC milliamps, ACV Trms, AC mA Trms, Process input (with and without excitation), Thermocouple, RTD, Strain gage, Pressure, Resistance, Frequency, and others, some with dual inputs. See pages 13-15 for more details.

## DISPLAY BOARD TO OPTIONAL OUTPUT MODULE INTERCONNECTION

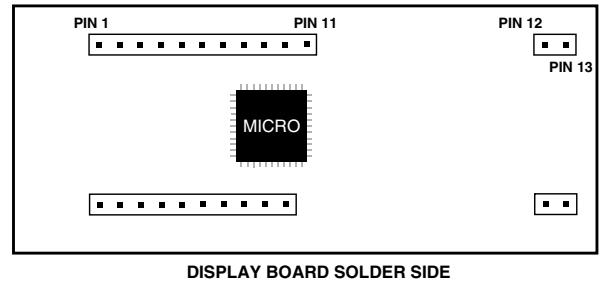

- Pin 1 - +5VDC @ 160mA Power.** For Relay Driver Circuits
- Pin 2 - Ground.** For Relay Driver Circuits
- Pin 3 - Reserved** for future use
- Pin 4 - To LOL1 Driver Circuit-Alarm Status**
- Pin 5 - Squarewave to Analog Output,** Frequency to Voltage Circuit
- Pin 6 - Reserved** for future use
- Pin 7 - To HIL1 Driver Circuit-Alarm Status**
- Pin 8 - RXD** (CMOS Logic Levels)
- Pin 9 - TXD** (CMOS Logic Levels)
- Pin 10 - To HIL2 Driver Circuit-Alarm Status**
- Pin 11 - To LOL2 Driver Circuit-Alarm Status**
- Pin 12 - Isolated Ground.** For Analog Output Circuit.
- Pin 13 - +18VDC @ 30mA Power.** For Analog Output Circuit.

# OPTIONAL OUTPUT MODULE

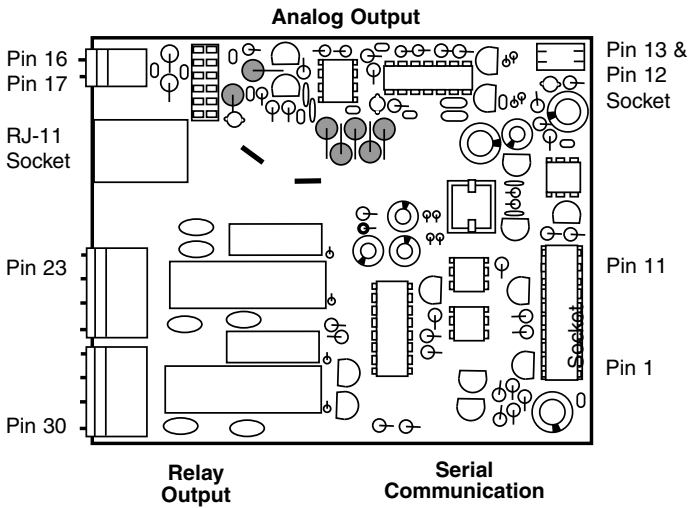

## Component Side

Output options include up to four heavy duty, high isolation 5 and 10 amp relays that can be programmed individually to operate in any desired manner. An independently programmable analog output is available that can be user configured for 4-20mA, 0-20ma or 0 to 10VDC. The isolated serial output is available as RS-232C or RS-485. All or any combination of these options may be combined on one module. The above illustration shows a fully loaded Output Module with RS-232C Serial Communication. If any one of the output options is not included, the components are simply not placed.

# EXPLODED VIEW OF METER

In this view, the meter has been removed from the case. Visible is the Signal Conditioning Module, the Optional Output Module and the rear view of the Display Board.

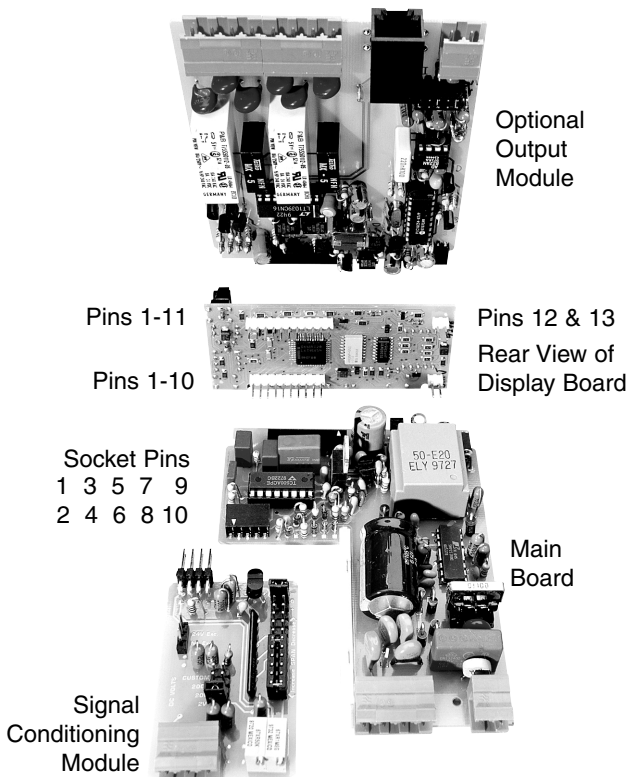

# OUTPUT MODULE PINOUTS

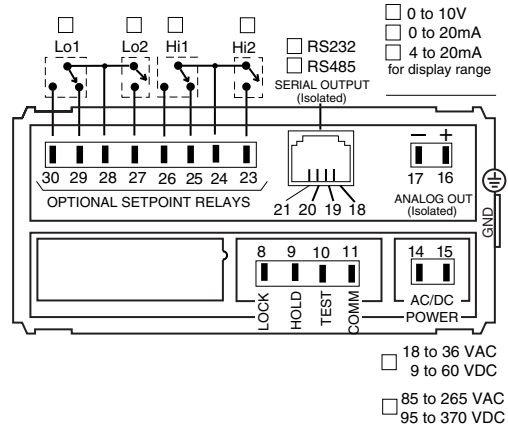

## ANALOG OUTPUT PINOUTS

User selectable 0-10VDC into 5KΩ maximum or 0-20mA DC into 500Ω maximum. Desired scaling for 4-20mA, 1-5VDC, 0-1VDC. Front panel programmable. Only one analog output per module.

- Pin 16** - Positive Analog Output
- Pin 17** - Negative Analog Output

**Analog Output Options Available**  
 Isolated Current output (0-20mA)  
 Isolated Voltage output (0-10VDC)

## SERIAL COMMUNICATION PINOUTS

Choose only one type of serial communication per module.

Pin No.	RS232C	RS485
18	RXD. Received Serial	B (Low)
19	TXD. Transmitted Serial	A (High)
20	+5 V DC to Power external converters	+5 V DC to Power external converters
21	Isolated Ground	Isolated Ground

**Serial Communication Outputs Available**  
 Isolated RS232C  
 Isolated RS485

## RELAY OUTPUT PINOUTS

Choose up to four relays per module. User software selectable NO/NC relay status. LoL1/HiL1 are 10Amp/240VAC high insulation Form C relays. LoL2/HiL2 are 5 Amp/240VAC high insulation Form A relays.

- Pin 23** - Normally Open HiL2. 5A/240VAC Contact.
- Pin 24** - Common HiL1 and HiL2
- Pin 25** - Normally Closed HiL1. 10A/240VAC contact.
- Pin 26** - Normally Open HiL1. 10A/240VAC contact.
- Pin 27** - Normally Open LoL2. 5A/240VAC contact.
- Pin 28** - Common LoL1 and LoL2
- Pin 29** - Normally Closed LoL1. 10A/240VAC contact.
- Pin 30** - Normally Open LoL1. 10A/240VAC contact.

**Relay Output Outputs Available**  
 One 10A/240VAC Form C  
 Two 10A/240VAC Form C  
 Two 10A Form C/One 5A Form A  
 Two 10A Form C/Two 5A Form A

# TYPICAL APPLICATION CIRCUITS & CONNECTION INSTRUCTIONS

The DI-50D may be used in a wide variety of applications. The following circuits illustrate some of the possibilities and demonstrate the exceptional versatility of DI-50D. Components called for in the applications which are not part of the standard meter may be supplied by the user or in some cases purchased from Texmate. The circuit diagrams explain the basic pinout connections required for each application. **NOTE:** Use of these application circuits is entirely at the risk and responsibility of the user and any user modification of the meter may at the discretion of Texmate, void the warranty. (See rear page for user's responsibility and warranty details.)

## SINGLE INPUT SIGNAL CONDITIONING MODULES

See individual module data sheets for more information. Order numbers for each module are the three letter codes shown in bold.

**A01:** AC Volts Average High 200V/600V AC

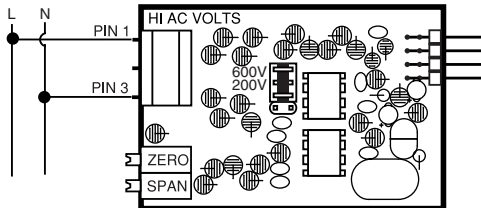

**A02:** AC Volts Average Low 200mV/2V/20V AC

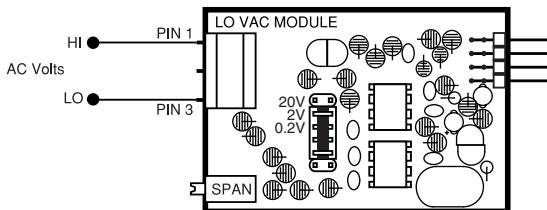

**A03:** AC mA Averaging 2mA/20mA/200mA AC

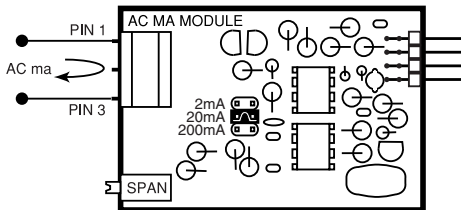

**A04** (1 A AC) or **A05** (5 A AC): AC AMPS Averaging 1 A AC or 5 A AC

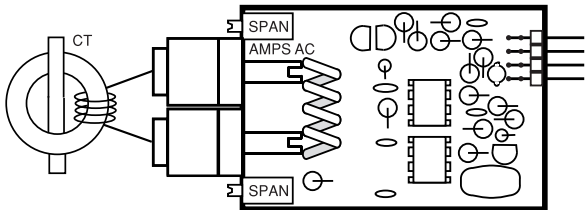

**A06:** AC Volts Trms High 200V/600V AC

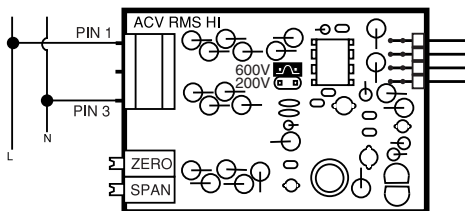

**A07:** AC Volts Trms Low 200mV/2V/20V AC

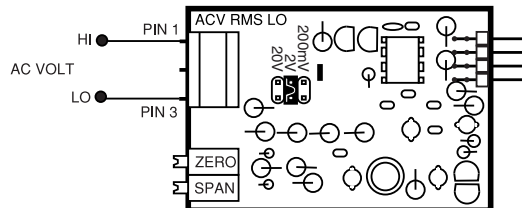

**A08:** AC mA Trms 2mA/20mA/200mA AC

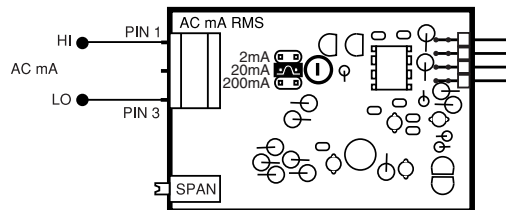

**A09** (1 A AC) or **A11** (5 A AC): AC AMPS Trms 1 A AC or 5 A AC

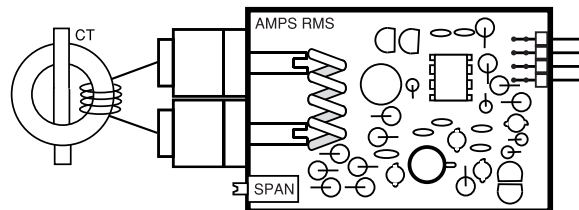

**D01:** DC Volts 2/20/200 V DC

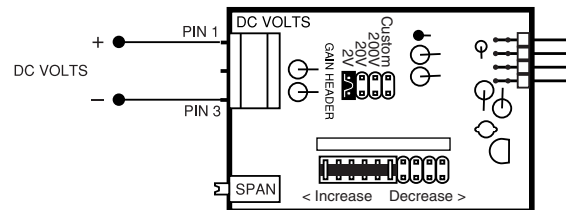

**D02:** DC Millivolts Universal Divider 20/50/100/200 mV

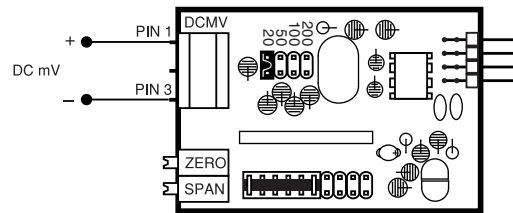

**D03:** DC Milliamps Universal Divider 2/20/200 mA  
Optional 0.2mA Range Available

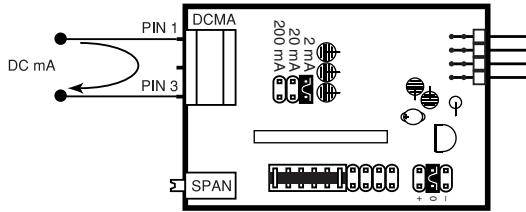

**D04:** DC mAmps, 1 or 5 Amps DC Direct  
(Please specify when ordering)

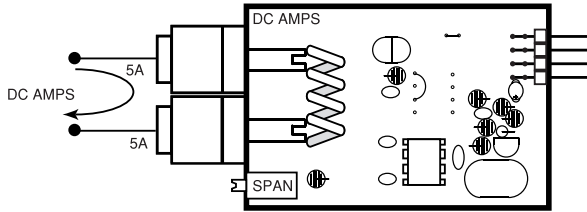

**D05:** DC-VOLTS, 2/20/200/600 V DC range and  
24 V DC excitation

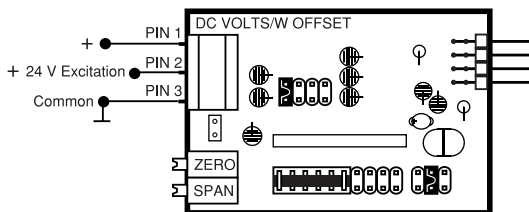

**D06:** DC-VOLTS, 2/20/200/600 V DC range with  
External Decimal Point selection

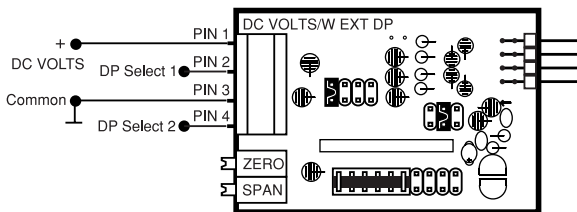

**D07:** DC-MILLIAMP, 2/20/200 mAmps DC with  
offset adjustment

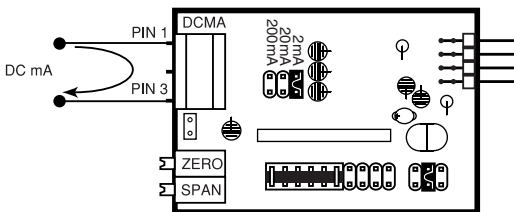

**F01:** RPM-20 V AC, 5-30 V DC, 3 selectable ranges;  
0-2 kHz, 0-20 kHz and 0-200 kHz

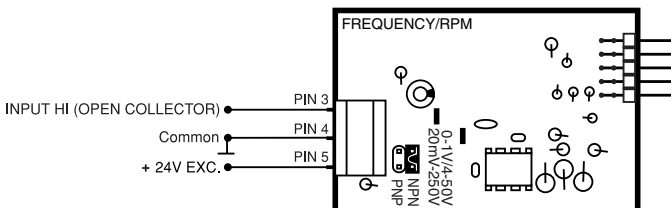

**F02:** Line Frequency 50 to 500 V AC, 3 selectable  
ranges; 0-2 kHz, 0-20 kHz and 0-200 kHz

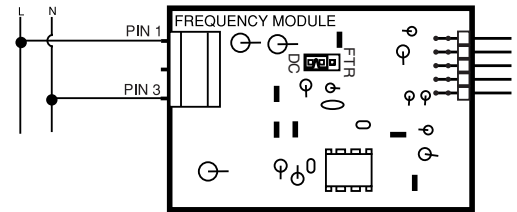

**F03:** Frequency 1 to 50 V AC 5-30 V DC, 3 selectable  
ranges; 0-2 kHz, 0-20 kHz and 0-200 kHz

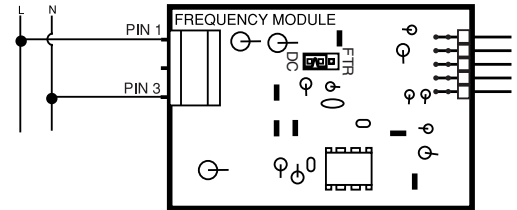

**P01:** Process 4-20 mA = 0-10000

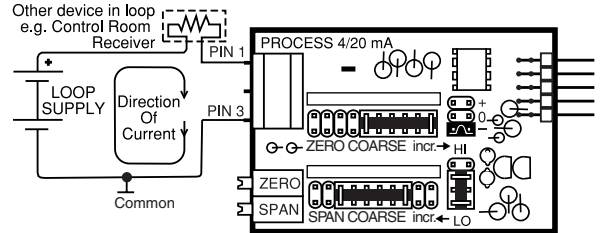

**P02:** Process 4-20 mA = 0-10000 with 24 V DC Excitation

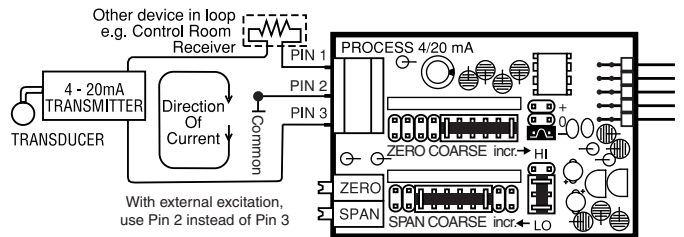

**P03:** Process 1-5 V DC = 0-10000 with offset  
adjustment and 24 V DC Excitation

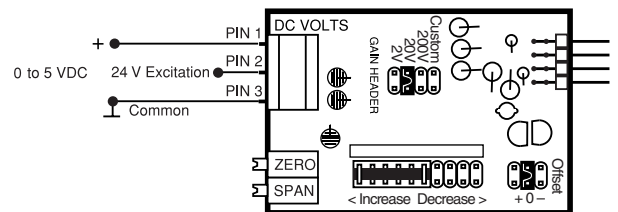

**PT1:** Prototype bare board for customer design and build

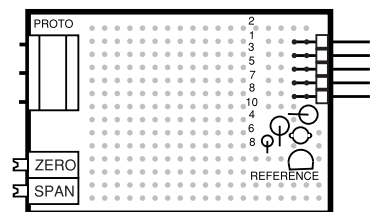



**TYPICAL SINGLE INPUT MODULES** continued

**R01:** Resistance (2-,3-,4- wire) 200 Ω/2K Ω/20K Ω

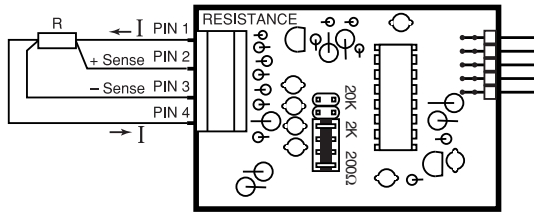

**S01:** Strain Gage with 5/10 V DC Excitation, 2 mV/V to 20 mV/V, 4 or 6 wire

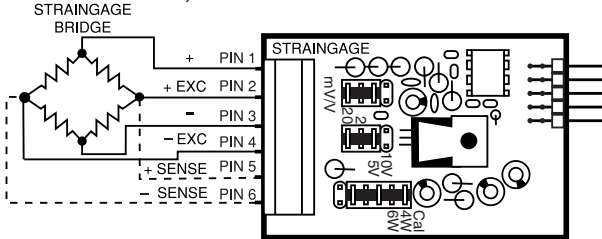

**S02:** Pressure with 5/10 V DC Excitation, 2 mV to 20 mV/V, 4 or 6 wire

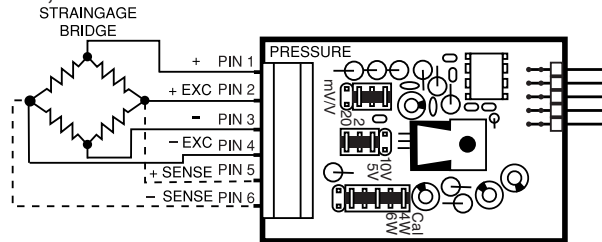

**S03:** Pressure with Auto-cal 5/10 VDC Excitation, 2 mV to 20 mV/V - 4 wire

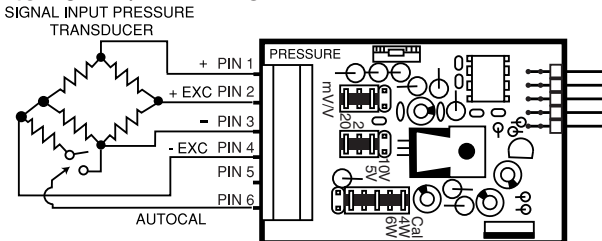

**S04:** Pressure, without excitation, For use with multiple Pressure Sensor 4-wire or 6-wire, 2 mV/V–20 mV/V

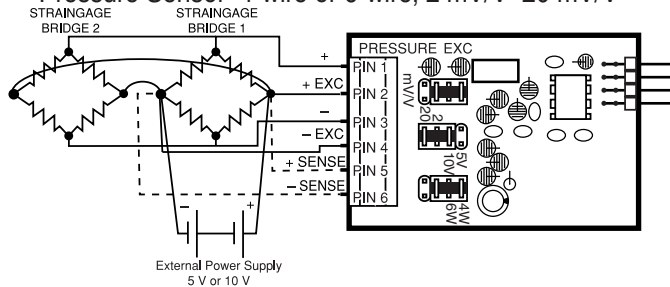

**T01:** Thermocouple Universal, J, K, R, S or T.

NOTE: For any other TC, Contact TEXMATE

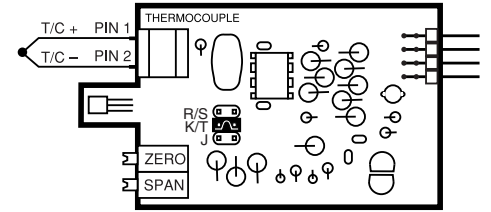

**T02:** Pt. 100Ω RTD–(2-,3-,4- wire) 0 to 200.0°C (32.0 to 392.0°F) -200 to 800°C (-328.0 to +1472.0°F). a curve 385  
NOTE: For Pt 1000 Ω, Contact TEXMATE

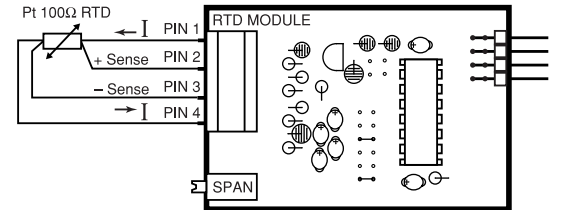

**T05:** Cu 10 Ω Copper (2-,3-,4- wire) 0 to 200.0°C (32.0 to 392.0°F) -200 to 800°C (-328.0 to +1472.0°F)

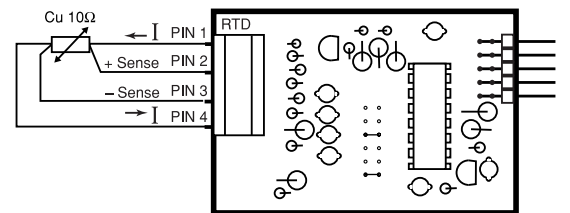

**T12:** Infrared Temperature Sensor Input using 32Pt. Linearization

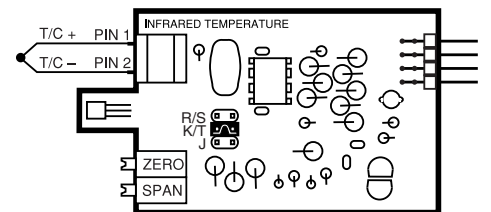

**W01:** Watt Input 300 VAC/1 Amp AC 1Ph/2 Wr

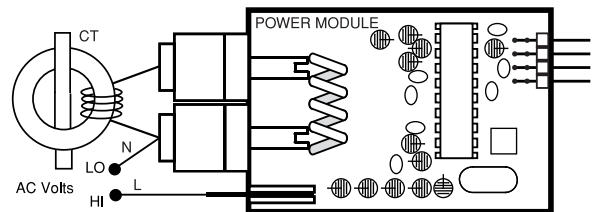

**W02:** Watt Input 300 VAC/5 Amp AC 1Ph/2 Wr

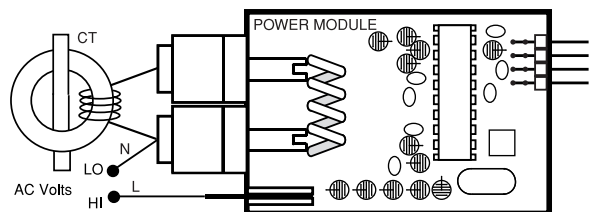



# TYPICAL DUAL INPUT MODULES

## DD1: Dual Input Volts DC/Volts DC

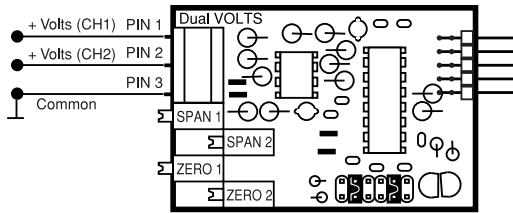

## DD2: Dual Input mV DC/mV DC

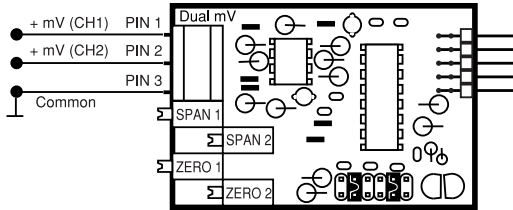

## DD3: Dual Input mA DC/mA DC W/Excitation

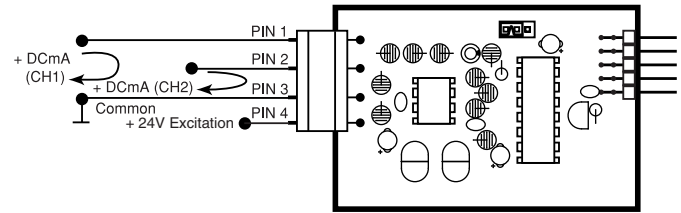

## DP1: Dual Process 4-20 mA/4-20 mA

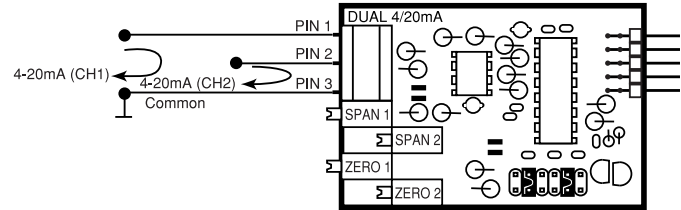

## CONNECTORS

The DI-50D TIGER comes standard with plug-in screw terminal blocks. To connect the instrument, make sure the screw terminal block is securely attached to the pin socket on the printed circuit board. For each input required, loosen the screw above the designated input (see specific module sheets or meter label for input diagrams), place input wire into the square opening below screw, then retighten screw.

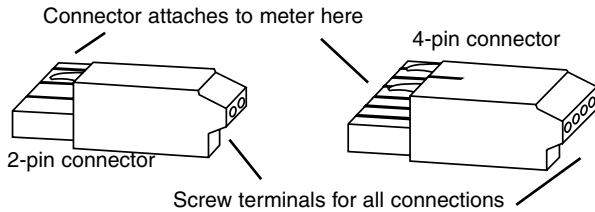

## CALIBRATION

The DI-50D TIGER is a precision digital panel instrument using Dual Slope integration capable with 16 bit resolution employing 'intuitive software' (available from the front panel or through the serial multiple meter software interface) to select the input signal type and scaling. The display averaging and rounding ensures stable displayed readings and outputs. All signals may be scaled for desired engineering unit.

**CALIBRATION:** The DI-50D TIGER meter is calibrated prior to shipment, using equipment certified to NIST standards. Calibration constants are stored in non-volatile memory in a EPROM. Recalibration for units installed with a serial interface is completed using the application software supplied with the meter. If the unit does not have a serial interface, it must be returned to Texmate for recalibration.

## CASE DIMENSIONS

Front panel cutout  
Bezel size (W x H x D)

3.63" W x 1.78" H (92 x 45 mm)  
3.79" W x 1.9" H x 0.23"D (96 x 48 x 5.7 mm), black

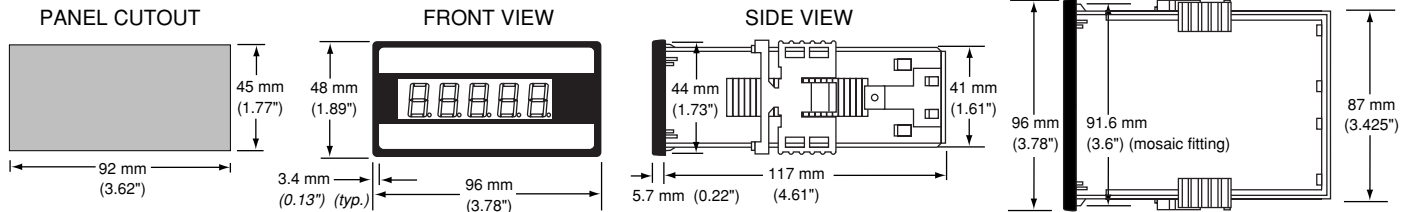

### WARRANTY

Texmate warrants that its products are free from defects in material and workmanship under normal use and service for a period of one year from date of shipment. Texmate's obligations under this warranty are limited to replacement or repair, at its option, at its factory, of any of the products which shall, within the applicable period after shipment, be returned to Texmate's facility, transportation charges pre-paid, and which are, after examination, disclosed to the satisfaction of Texmate to be thus defective. The warranty shall not apply to any equipment which shall have been repaired or altered, except by Texmate, or which shall have been subjected to misuse, negligence, or accident. In no case shall Texmate's liability exceed the original purchase price. The aforementioned provisions do not extend the original warranty period of any product which has been either repaired or replaced by Texmate.

### USER'S RESPONSIBILITY

We are pleased to offer suggestions on the use of our various products either by way of printed matter or through direct contact with our sales/application engineering staff. However, since we have no control over the use of our products once they are shipped, **NO WARRANTY WHETHER OF MERCHANTABILITY, FITNESS FOR PURPOSE, OR OTHERWISE** is made beyond the repair, replacement, or refund of purchase price at the sole discretion of Texmate. Users shall determine the suitability of the product for the intended application before using, and the users assume all risk and liability whatsoever in connection therewith, regardless of any of our suggestions or statements as to application or construction. In no event shall Texmate's liability, in law or otherwise, be in excess of the purchase price of the product.

Texmate cannot assume responsibility for any circuitry described. No circuit patent licenses are implied. Texmate reserves the right to change circuitry, specifications, and prices without notice at any time.



995 Park Center Drive • Vista, CA 92083-8397  
Tel: (760) 598-9899 • Fax: (760) 598-9828  
URL: <http://www.texmate.com>

Texmate has facilities in Japan, New Zealand, Taiwan, and Thailand. We also have authorized distributors throughout the USA and in 28 other countries.

### Local Distributor Address