



GI-50E & GI-50T

**Programmable Meter Controllers
Tiger 320 Series PMCs
5 Digit 1" LEDs
in a 9/32 DIN Case**



A powerful, intelligent, 5-digit Programmable Meter Controller (PMC) with modular outputs, input signal conditioning and advanced software features for monitoring, measurement, control and communication applications.

General Features

- The Tiger 320 Operating System supports an easy to use PC based Configuration Utility Program, which can be downloaded FREE from the web, and programming from front panel buttons.
- The T Version supports custom macro programs that can be easily produced with the Tiger 320 Macro Development System (available FREE on the web). The Development System enables programs to be written in BASIC, which can utilize any combination of the hundreds of functions and thousands of registers embedded in the Tiger 320 Operating System.
- Red, green, or superbright red 7-segment, 1" high LEDs with full support for seven segment alphanumeric text.
- Brightness control of LED display from front panel buttons.
- Modular construction with more than 120 interchangeable input signal conditioners and more than 25 interchangeable I/O modules.
- Up to 4 input channels with cross channel math for multi-channel processing.
- For applications where sensor excitation is required, modules are provided with 5V, 10V or 24 V DC voltage outputs.
- On demand tare, calibration and compensation can be initiated by the front panel program button.
- Autozero maintenance for super stable zero reading is provided for use in weighing applications.
- Programmable input averaging and smart digital filtering for quick response to input signal changes.
- Display text editing. Customize display text for OEM applications.
- Scrolling display text messaging on T meters with macros.
- Auto-sensing high voltage or optional low voltage AC / DC power supply.
- Serial output options include RS-232, RS-485, ModBus or

direct meter-to-meter communications.

- Single or dual 16-bit Isolated Analog Outputs. Programmable 0~4 to 20mA or 0 to 10V for retransmission, 4-20mA loops to drive valve actuators, remote controllers & displays, multi-loop feedback and PID output. Scalable from 1 count to full scale.
- Dual independent totalizers to integrate input signals.
- 6 super smart, independently programmable setpoints with 8 selectable functions, including latching, deviation, hysteresis, register resetting, tracking and dual PID. Plus 7 programmable timer modes on all 6 setpoints.
- Setpoint tracking, setpoint latching and manual relay reset.
- Setpoints activated from any input, any register in the meter or from any digital input.
- Plug-in I/O modules include electromechanical or solid state relays, logic outputs or open collector outputs. 6 inputs & 16 outputs of opto-isolated I/O can be connected to an external DIN Rail terminal block module.
- Internal program safety lockout switch to prevent tampering.
- Peak & valley (max & min) with front panel recall and reset.
- Real time clock with 15 year Lithium battery backup.
- Data logging within the meter (up to 4000 samples with date/time stamp).
- Optional NEMA-4 front cover.

Input Module Compatibility

TIGER FAMILY: More than 120 different Plug-in I-Series Input Signal Conditioners are approved for the Tiger Family of meters.

See *I-Series Input Signal Conditioning Modules Guide (Z87)* for an up-to-date list.





Table of Contents

General Features	1	Controls & Indicators	14-15	Functional Diagram	45
Specifications	2	Front Panel Configuration & Setup	16	Connector Pinouts	45
Tiger 320 Series Literature Overview	3	Front Panel Programming Codes	17-18	Carrier Board Output Pins	46
Tiger 320 Series System Overview	4-5	Initial Setup Procedures	19-20	Relay and Logic I/O Modules	46
Planning to Use the Tiger 320	6-8	Display Brightness	20	Component Layout & Ext. Devices	47-48
Block Diagram of Tiger 320 Structure	9	Calibration Modes	21-24	I-Series Input Modules	49-55
Configuration Utility Program	10	Programming Procedures	25-37	Ordering Information	56-58
Custom Macro Program	11	Setpoint Programming Mode	38-43	Custom Faceplates	59
Index	12-13	Registers	44	Case Dimensions	60

Specifications

Display

- Digital Display:** 7-segment, 1" (25.4 mm) LEDs.
- Display Color:** Red (std). Green or Super-Bright Red (optional).
- Digital Display Range:** -19999 to 99999
- Update Rate:** 3 to 10 times per second
- Display Dimming:** 8 brightness levels. Front Panel selectable
- Scrolling Display Text Messaging:** Full alphanumeric, 7-segment text characters supported on T Version with macros.
- Polarity:** Assumed positive. Displays - negative
- Decimal Point:** Front panel, user selectable to five positions.
- Annunciators:** 6 red LEDs on front panel; one per setpoint.
- Overrange Indication:** 
- Underrange Indication:** 
- Front Panel Controls:** PROGRAM, UP and DOWN.

Operating System (Tiger 320)

- Processor:** 32 bit with floating point maths (18.4 MHz).
- Flash Memory:** 64k, 4k for use by custom macros.
- RAM:** 1.25k and FeRAM 4k.
- EEPROM:** E Version 4k standard, T Version 32k standard. Memory upgrades available to 32k for LIN Tables and 1MB for Data Logging and custom macros.
- Registers:** 6144 registers comprised of 8, 16 or 32 bit signed, unsigned or floating point registers, implemented in a combination of RAM, FeRAM, Flash and EEPROM.
- Internal communication BUS:** 32 bit I²C BUS
- Real Time Clock (option):** Year:Month:Date:Hour:Minute:Second with 15 yr Lithium battery backup.
- Configuration:** Supports Front Panel Programming Codes and a PC-based Configuration Utility Program, which may be downloaded free from the web. T Version also supports custom macros.

Development System for Custom Macros

The Tiger 320 Macro Development System, which may be downloaded free from the web, can be used to create powerful macro software that allows Tiger 320 T Versions to be easily customized to suit any proprietary OEM application (see page 11).

Installed Application Software Includes

- Counter Functions:** Two built-in counters. UP counters, DOWN counters, UP/DOWN counters and high speed quadrature counters.
- Data Logging:** Logging with a date/time stamp, initiated at timed intervals, by activation of a setpoint, or manually. Data stored in internal 1MB EEPROM or in a removable 4 to 128M Flash Card Memory Module. Endless loop recording is supported.
- Input Compensation:** Provides compensation to the primary input channel (CH1) via channels 2, 3 or 4.
- Linearization:** 4 selectable 32 point or one 125 point flexible linearization tables are provided.
- Logic I/O:** 28 Macro programmable I/O ports supported.
- Manual Loader:** Front panel adjustable, 4 to 20mA or 0 to 10V isolated analog output.
- Math Functions:** Cross channel math functions to calculate the sum, difference, ratio or the product of two inputs.
- On Demand Functions:** Tare, compensation and calibration.
- Peak and Valley:** The meter can retain peak and valley (min/max) information and recall this on the front panel.
- Remote Setpoint Input:** Remote setpoint input via channel 2.
- Serial Output Protocols:** Selectable communication modes include ASCII, Modbus (RTU), Master Mode (for meter to meter communication) and an Epson compatible printer driver. DeviceNet and Ethernet optional output carrier boards are also supported.
- Setpoint Functions:** Six super smart setpoints with fully configurable hysteresis, on and off delays, one shot, pulse and repeat timers, latching, dual PID, setpoint tracking, resetting of registers, initiating of logging and printing.
- Signal Conditioning Functions:** Averaging, smart filter, rounding, square root, auto zero maintenance.
- Timer:** Timer functions supported in either time-up, time-down, or real-time clock modes.
- Totalizer:** Two totalizers for running total and batch totals of a process signal that can be accumulated over time.

Inputs

- Inputs Available:** More than 120 single, dual, triple and quad input signal conditioners available covering all types of analog, digital and mixed input signals (see page 49).
- Accuracy:** Tiger 320 PMCs enable the user to establish any degree of system accuracy required. Built-in compensation and linearization functions enable system accuracies of the order of $\pm 0.0001\%$ of reading for analog inputs. Stop -Start time resolution from $\pm 1\text{sec}$ to $\pm 0.7\text{nsec}$. Digital input and pulse counts ± 1 count.
- A/D Convertors:** A Dual Slope, bipolar 17 bit A/D is provided as standard on the main board. SMART modules can have 24 bit or 16 bit Delta-Sigma A/D convertors that utilize the internal I²C BUS.
- Temperature Coefficient:** Typically 30ppm/ $^{\circ}\text{C}$. Compensation can be utilized to achieve system temperature coefficients of 1ppm.
- Warm Up Time:** Up to 10 minutes, depending on input module.
- Conversion Rate:** Typically 10 samples per second. However, SMART input modules are available that can convert at 60, 240, 480 or 960 samples per second.
- Control Output Rate:** Can be selected for 100msec or 10msec. Some SMART modules have SSR outputs that react within 1.2msec.
- Excitation Voltage:** Depends on input module selected. Typically, 5V, 10V or 24VDC is provided.

Outputs (See pages 46-47 for pinouts and details of modular construction)

- Standard Carrier Board:** Is available without a serial output, or with either an isolated RS-232 or an isolated RS-485 (RJ-6 socket).
- Two Isolated Analog Output Options:** Mounted on any carrier board.
- 1. Single Analog Output:** Fully scalable from 4 to 20mA or 0 to 20mA (or reverse) and selectable for 0 to 10VDC (or reverse).
 - 2. Dual Analog Output:** Fully scalable from 0 to 10VDC (or reverse).
- Analog Output Specifications:** Accuracy: 0.02% FS. Resolution: 16-bit Delta-Sigma D/A provides 0.4 μA on current scaling, 250 μV on voltage scaling. Compliance: 500 Ω maximum for current output. 500 Ω minimum for voltage output. Update Rate: Typical 7 per second. Step Response: Typical 6msec to a display change. Scalable: From 1 count to full scale.

Seven I/O Modules: Plug into any carrier board from rear.

- 1. Four Relay Module:** Available in six combinations from one relay up to a total of two 10A Form C Relays* and two 5A Form A Relays**.
 - 2. Four Relay Module:** Available with one to four 5A Form A Relays**.
 - 3. Six Relay Module:** Available with five or six 5A Form A Relays**.
- *Form C Relay Specifications:** 10A 240VAC~1/2 HP, 8A 24VDC. Isolation 3000V. UL and CSA listed.
- **Form A Relay Specifications:** 5A 240VAC, 4A 24VDC. Isolation 3000V. UL and CSA listed.
- 4. Four Solid State Relay (SSR) Module:** Available with one to four independent (210mA DC only) or (140mA AC/DC) SSRs (400V max).
 - 5. Six Output 5VDC / TTL or Open Collector:** Available with 0 to 5V or 0 to V+ (40VDC max).
 - 6. Opto Isolated I/O Module:** Available in either 6 Outputs & 6 Inputs, or 16 Outputs and 6 Inputs. For connection to an external breakout box.
 - 7. Flash Card Memory Module:** Available with 8 or 16 MB memory.

Power Supplies

- Auto sensing AC/DC (DC to 400Hz) hi volts std, low volts optional.
- PS1 (standard):** 85-265VAC / 95-370VDC @ 4W max 5W.
- PS2 (optional):** 14-48VAC / 10-72 VDC @ 4W max 5W.

Environmental (See Rear page for IP-65 & NEMA-4 options)

- Operating Temperature:** 0 to 50 $^{\circ}\text{C}$ (32 $^{\circ}\text{F}$ to 122 $^{\circ}\text{F}$).
- Storage Temperature:** -20 $^{\circ}\text{C}$ to 70 $^{\circ}\text{C}$ (-4 $^{\circ}\text{F}$ to 158 $^{\circ}\text{F}$).
- Relative Humidity:** 95% (non-condensing) at 40 $^{\circ}\text{C}$ (104 $^{\circ}\text{F}$).

Mechanical (See Rear page for more details)

- Case Dimensions:** 9/32 DIN, 144x72mm (5.69" x 2.84")
- Case Material:** 94V-0 UL rated self-extinguishing polycarbonate.
- Weight:** 11.5 oz (0.79 lbs), 14 oz (0.96 lbs) when packed.

Approvals

- CE:** As per EN-61000-3/4/6 and EN-61010-1.

Tiger 320 Series Modular Literature Overview

► The Tiger 320 Series, Modular Literature system, makes it easy to select detailed information about those specific functions required for your application and the Configuration of the Tiger 320 you intend using.

Copies of all Data Sheets / User Manuals and Supplements can be viewed page-by-page and/or downloaded from the document server on our website.

Programming Code Sheet

Generic to all Tiger 320 Series models, the Programming Code Sheet is a quick reference document that allows you to quickly view the meter's manual programming codes.



Shipped with each product ordered, copies are also available on request, or can be viewed and downloaded from the document server on our website.

Model Specific Data Sheet / User Manual



Specific to each 320 Series meter model, the data sheet / user manual describes the basic functions of the meter and how to configure the meter for these functions.

Shipped with each product ordered, copies are also available on request, or can be viewed and downloaded from the document server on our website.

The model specific data sheet / user manual contains:

- Technical Specifications
- Overview of Tiger 320 Series Software and Hardware
- Planning Guide
- Block Diagram of the Tiger 320 Software and Hardware
- Configuration Utility Program
- Custom Macro Programming
- Front and Rear Panel Controls
- Front Panel Button Manual Programming Codes Overview
- Programming Procedures
- Functional Diagram and Pinouts
- Hardware Layout and Available Input and Output Modules
- Meter Options, and Custom Faceplates
- Ordering Information

Supplements to Data Sheet / User Manual are Generic to all Tiger 320 Models

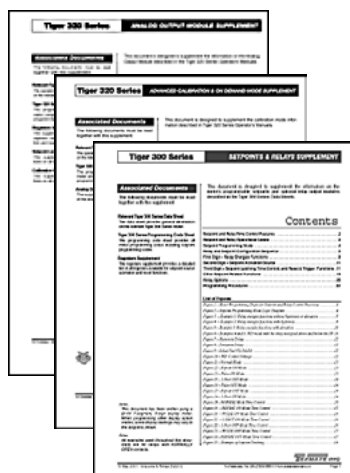

Generic to all Tiger 320 Series models, each supplement provides in-depth technical and procedural information on all individual meter modules, functions, or applications.

Listed are the supplements which are currently available:

Specific supplements are shipped with each product ordered to suit our customer's application. Copies are also available on request, or can be viewed and downloaded from the document server on our website.

- Advanced Calibration and On DEMAND Mode
- Analog Output Modules
- BASIC to Tiger 320 MACRO-Language Program Development System, Compiler and Tutorial
- Configuration Utility Program (Runs on PC)
- Linearizing Functions
- Meter Registers (for Macro Programming)
- Serial Communications Output Modules
- Setpoints & Relays
- Totalizing & Batching Functions

Other Tiger 320 Series Related Literature

Tiger 320 Functional Overview



A Quick Overview of the Awesome Power of the Tiger 320 Series

Tiger 320 Application Examples



Describes a Selection of Tiger 320 Applications

I-Series Input Signal Conditioning Modules



Includes all Available Input and Output Modules for the Tiger, Leopard and Lynx Families of Meters

Smart Module Data Sheets

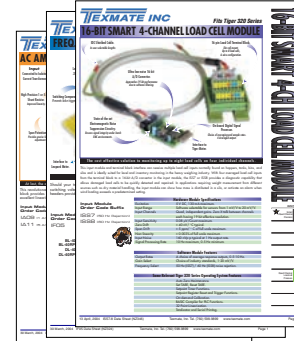

Data Sheets for All Smart Input and Output Modules

An Overview of the Awesome Power of the Tiger 320 Series

The Tiger 320 Series of 32-bit Programmable Meter Controllers incorporates, in one instrument, all the different functions required by today's automation and process control applications.

1 Tiger 320 32-Bit Operating System

A virtual toolbox of selectable and programmable application software functions are embedded in the Tiger 320 Operating System. They integrate seamlessly with a truly vast array of modular input and output hardware options.

Embedded Application Software Includes:

- Multi-channel Inputs In Many Combinations
- Full Floating-point Maths
- Cross Channel Math (A+B, A-B, AxB, A/B)
- Square Root, Inverse and Log of Input
- 4 x 32 Point Or 1 x 125 Point Linearization Table
- Smart Auto Zero with Programmable Capture Band, Rate of Change and Aperture Window for Weighing Applications
- Set Tare Reset Tare for Batching
- Smart Quick Response Averaging
- Smart Timer and Time Integration Functions
- Time and Event-based Sequencing
- Polynomial Calculations
- Remote Reset of Any Function
- Dual Totalizers
- Dual PID

2 Data Logging and Memory Options

Up to 1MB of non-volatile on-board memory can be installed for (Black Box) endless loop recording. Up to 4000 data records can be continuously stored to provide before and after analysis of any process fault condition.

- Data log from 4 channels.
- Data log from 2 channels with date & time stamp.
- Log / print from setpoint or timer.

A Plug-in I/O Module is available with removable Flash Card Memory for high-capacity or long-term data logging.

Flash Cards are available from 4 to 128 Meg.

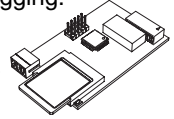

3 Real-time Clock



Optional Real-time clock with date and time stamp.
15 year lithium battery.

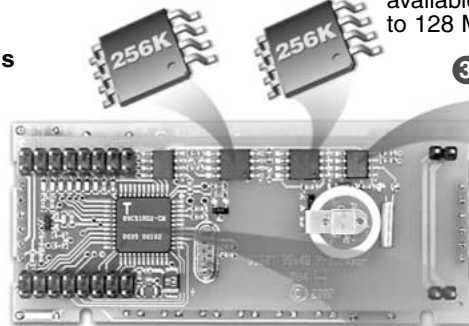

4 Powerful Custom Macro Programming Capability

Texmate's BASIC to Tiger 320 Macro-language Compiler can quickly Convert your special metering, control and automation ideas into reality.

This powerful easy to use development system enables programs to be written in BASIC utilizing any combination of the hundreds of functions and thousands of registers embedded in the Tiger 320 Operating System. When your BASIC program is compiled into the Tiger 320 Macro-language it is error checked and optimized. There are also numerous off-the-shelf application specific programs available. Many only need the blanks to be filled in to use them and this does not require any knowledge of BASIC.



Scrolling annunciator messages can be programmed to appear with any setpoint activation, selected events or logic inputs.

5 Programmable Front Panel Controls

Programmable Front Panel Controls

The front panel buttons can be used to control or program any standard functions.

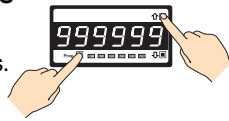

They can also be programmed to only access and display specifically designated functions, such as Tare, Auto-Cal or Print on Demand.

6 Configuration & Programming from a PC

PC Programming

Program the meter from a PC with Texmate's easy to use Tiger 320 Configuration Utility Program.

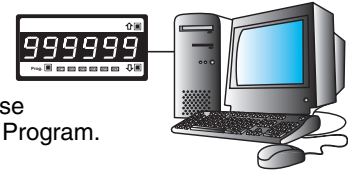

7 A Wide Selection of Display Formats & 8 Case Sizes to Suit any Application

Single or multiple LED or LCD displays
Numeric, Alpha Numeric and Bargraph

144x72mm 9/32 DIN

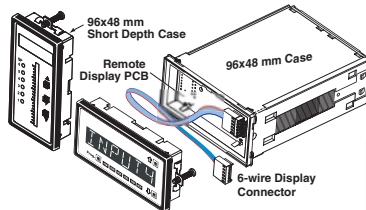

96x48mm 1/8 DIN



36x144mm 9/64 DIN

648x144mm 4" LED Remote Display 5 or 6 digit Driven by RS485 from any Tiger 320

48x96mm 1/8 DIN



8 22 Opto-Isolated I/Os on Plug-in Module & 6 Onboard Programmable I/O Logic Ports

- 6 Inputs & 16 Outputs or 6 Inputs & 6 Outputs
- Fully Programmable



Connects to DIN Rail terminal block module with 3M IDC cable

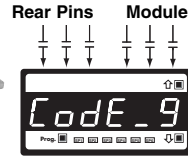

Three logic level inputs are provided on the module input header and three rear input pins are provided that can be programmed to STOP/START/RESET almost any function including: set tare, reset tare, relays, totalizers, print output, data logging, peak, valley, or any register from an external contact closure.

9 6 Super Smart Setpoints - 8 Selectable Functions - 7 Programmable Timer Modes

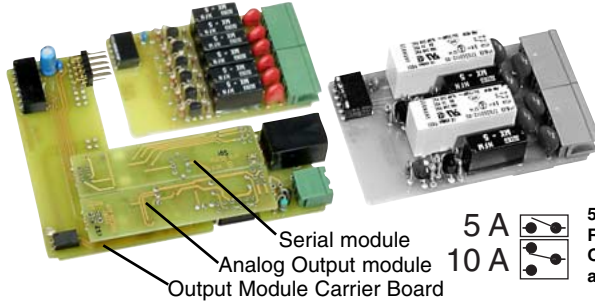

Serial module
Analog Output module
Output Module Carrier Board

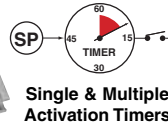

Single & Multiple Activation Timers

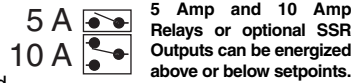

5 Amp and 10 Amp Relays or optional SSR Outputs can be energized above or below setpoints.

7 Multi Function Interval Timers on all 6 setpoints

- NormalAdjustable Delay On Make / Adjustable Delay On Break
- 1-Shot ONAdjustable Delay On Make / Adjustable Min ON-Time
- 1-Shot OFFAdjustable Delay On Break / Adjustable Min OFF-Time
- Pulse ONAdjustable Delay On Make / Adjustable Max ON-Time
- Pulse OFFAdjustable Delay On Break / Adjustable Max OFF-Time
- Repeat ONAdjustable ON-Time / Adjustable OFF-Time
- Repeat OFFAdjustable OFF-Time / Adjustable ON-Time

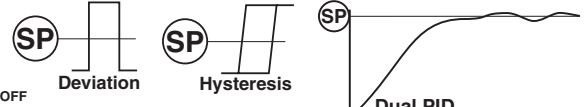

Dual PID

10 Scrolling Annunciator

Scrolling Annunciator up to 99 Characters long is available on all 6 setpoints for Alphanumeric Displays with Fill-in-the-blanks Macro.

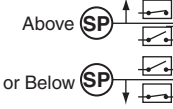

Activation

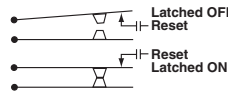

Relay Latching



SETPOINT TRACKING

*99 CHARACTER SCROLLING DISPLAY ON ALL SETPOINTS



12 16-bit Isolated Analog Outputs

Single

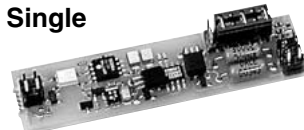

0 ~ 4-20mA or 0-10V

Dual

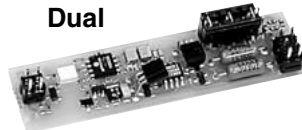

0-10V & 0-10V

Programmable 0~4 to 20 mA or 0 to 10 V for retransmission, 4-20 mA loops to drive valve actuators, remote controllers & displays, multi-loop feedback and PID output.

11 Serial Communications & Printer Output

RS-232

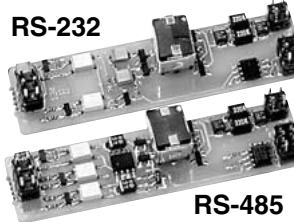

RS-485

Selectable Communication Modes include:

- ASCII
- Modbus
- Ethernet (TCP/IP)
- DeviceNet (with optional carrier board installed)

Interface directly with PCs (using Window's terminal program), PLCs, or any Epson compatible serial printer.

Serial Printer Output

Smart printer driver makes simple serial printers look intelligent.

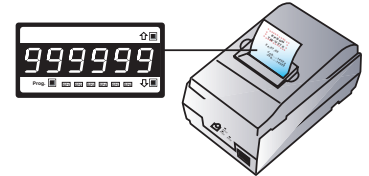

Meter to Meter Communication.

Direct meter to meter communication enables two meters to share data and resources.



13 Auto-sensing AC/DC Power Supply

- High Efficiency CE tested Auto Sensing AC/DC power supplies
 - Standard 85-265 Volt AC / 95-370 Volt DC
 - Low Voltage 9-32 Volt AC / 10-60 Volt DC

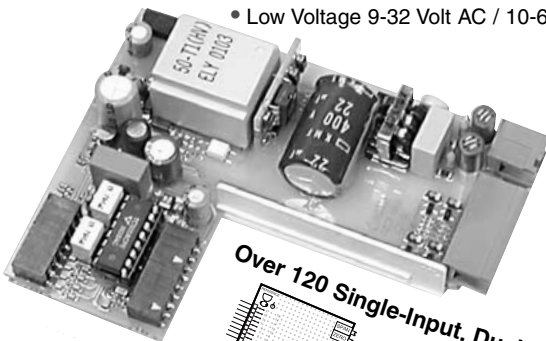

14 Over 120 Different Input Signal Conditioning Modules

- Choose from over 120 different single, dual, triple and quad input signal conditioners.
- Mixed function and smart modules with their own A/Ds, co-processors, SSRs and I²C Bus outputs are available to suit almost any application.

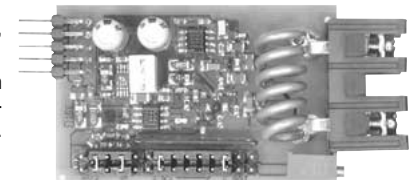

AC-Amps True RMS 0-5Amp AC

Over 120 Single-Input, Dual-Input, Triple Input and Quad-Input signal conditioners work with the Tiger 320 series

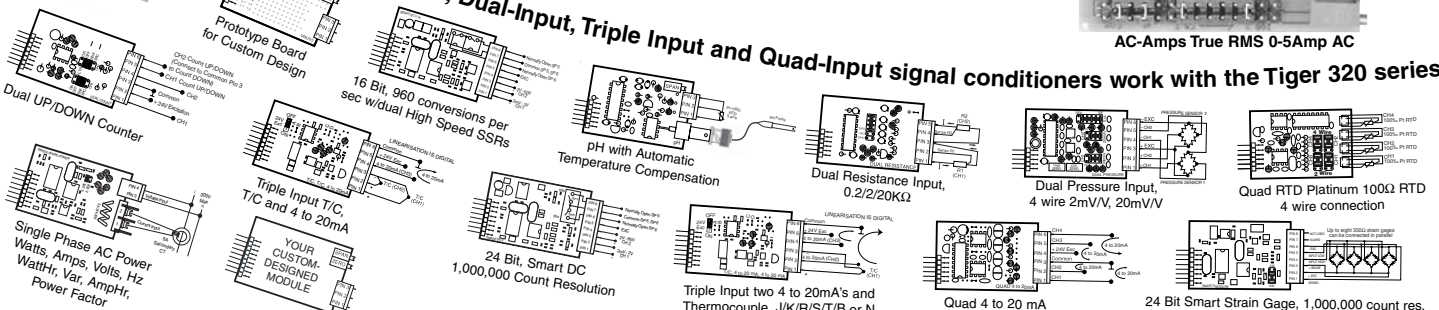

A combination of modular hardware and software resources enable Tiger 320 Series Programmable Meter Controllers (PMCs) to be easily configured as a cost effective solution for the most simple or the most complex of applications.

A review of your Project's objectives, its physical layout, the proposed sensors and control outputs will enable you to select the optimum configuration of the Tiger 320 PMC's unique hardware and software capabilities.

Input Signals & Sensors

4-20 mA or Sensor Direct

Unless sensors are located at a far distance, the greatest accuracy and best performance is usually obtained by connecting sensors directly to the Tiger 320, which will then function as the primary measurement device.

There are more than 120 Tiger compatible input signal conditioning modules, with the appropriate excitation outputs, to suit almost any type of sensor or combinations of up to 4 sensors.

In most cases, sensors with a 4-20 mA output are more costly, and when a separate 4-20 mA transmitter is used, signal conversion, drift, and calibration inaccuracies are introduced.

Some Tiger input modules combine direct sensor inputs with 4-20 mA inputs, enabling both local and far distant sensor inputs to be combined.

Sensor Linearization or Compensation

The performance of many sensors can be greatly enhanced or expanded with linearization and or compensation. Sensors may be compensated for temperature, frequency, altitude, humidity and mechanical position, to name just a few parameters.

Tiger PMCs with 32 kilobits or more of memory provide up to four 32-point user defined linearization tables or one combined 125-point table.

Many compensation methods can be implemented with the standard cross channel math capabilities of the Tiger's 32-bit operating system. Complex three-dimensional compensation can also be implemented using the powerful macro programming capability.

The serial number and calibration date of a sensor can be loaded into the meter. The serial number, linearization tables, and compensation factors of a newly calibrated sensor can then be saved for future reloading, either serially through a PC or directly through the web via an Ethernet port.

Although there are numerous input modules with combinations of various input signals, some inputs such as watts or pH are provided on input modules dedicated to a single function. Combining these inputs with each other signals two or more Tiger meters can serially communicate, and be configured to share their data and processing resources.

Display Options

Tiger PMCs have a large range of display options, including digital and alphanumeric LCDs, LEDs and Touch Panel HMIs.

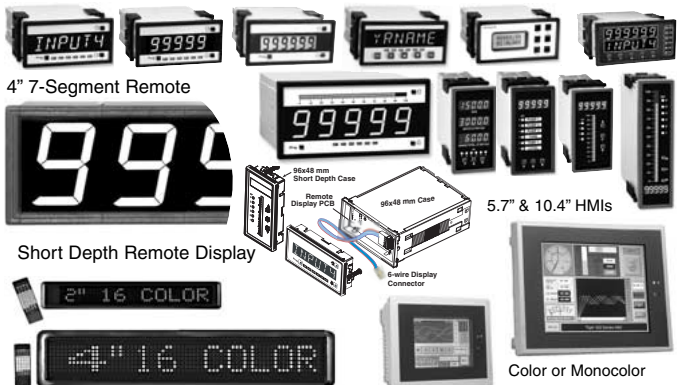

LED or LCD Displays

LED displays are a lower cost and popular display option. They operate over the largest temperature range, have better viewing angles and viewing distances, and have the longest operational life. However, red LEDs are difficult to read in direct sunlight without a shade hood and consume more power. Green LEDs and backlit LCD displays can be more easily read in direct sunlight.

The Tiger range can be ordered with red or green LEDs. LCD displays are also available, with or without backlighting.

Numeric or Alphanumeric Displays

Generally, numeric displays are a lower cost option than alphanumeric displays. The Tiger range supports a full 7-segment numeric and 14-segment alphanumeric alphabet of English letters and Arabic numerals. Where complex text messaging or alarm annunciation is required, we recommend using the 14-segment alphanumeric option.

Single or Multiple Display

The Tiger meter has four input channels and can be configured to display many different inputs or results. These can be viewed constantly on the operational display, or on demand in one of the view modes by pressing a button. Some applications require multiple values to be displayed simultaneously. With single, dual, or triple displays, and single displays with 51 or 101-segment bargraph combinations, we have a large range of display options to choose from.

Tiger meters can communicate with each other to share their data and processing resources and be stack or twin mounted to provide a wider range of display options.

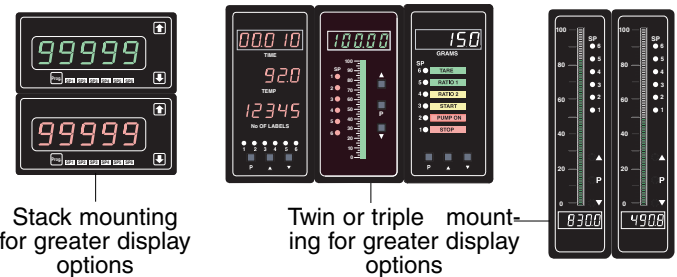

Push Button or Membrane Touch Pads

Tiger PMCs are shipped as standard with high usage hard plastic push buttons. An optional clear lens cover that opens on a cam hinge with a key lock can provide full NEMA 4 or IP65 dust and water proofing. Alternatively, an optional membrane touch pad faceplate can be ordered.



Control Outputs & I/O Logic

Electromechanical Relays or Solid State Control Outputs

Tiger PMCs have a wide selection of control outputs to choose from. The decision on which control output to choose depends on the current and the switching frequency.

Electromechanical relays are a popular choice for most control outputs. Tiger output modules are available with combinations of two 10 amp form C and two to six 5 amp form A relays that can be used to directly drive fractional HP motors or actuators.

The limitation of electromechanical relays is switching speed. If a relay needs to operate in less than 30 mS, or be cycled faster than .5 cpm, it is advisable to select an output module with solid state relays (SSR) or open collector outputs (OC), that can drive external high current SSRs.

DECISION **PID or On/Off Control**

Depending on the process to be controlled, either PID or on/off control should be selected. If the process variables are reasonably consistent, then the on/off control is generally more than adequate and easier to implement. Super smart setpoint control software supports many selectable functions, such as Hi or Lo activation, Latching, Hysteresis, Tracking, Register Resetting and 7 Multi-function internal Timers on all setpoints.

PLANNING TIP Control systems with large lag and lead times are not suitable for on/off control and tend to overshoot and undershoot. PID is needed to stabilize and control these systems. One of the many powerful setpoint functions provided by the Tiger 320 Operating System is single or dual PID.

DECISION **Retransmission 0-10V or 4-20mA**

Tiger PMCs can have an optional single (0-10 V or 0/4-20 mA) or dual (0-10 V) analog output module installed. The isolated 16-bit output is fully scalable and highly accurate. With a compliance of up to 500Ω at 20mA, the 4-20 mA output can be used over very long distances and still drive more than one output device, such as a PID controlled valve positioner.

PLANNING TIP The analog outputs can be reversed to output 20mA to 4/0 or 10 to 0VDC. They can be scaled across any portion of the digital range, up to full scale. The output can be programmed to swing 0 to 20mA or 0 to 10V in one digital count to drive external logic or SSRs as additional setpoints. Under Macro Program Control, the analog outputs can be programmed to produce pulses or even sinewaves.

DECISION **I/O Logic, Rear Panel or Breakout Box**

The Tiger Operating System has many built-in logic functions that can be used to develop sophisticated control systems. The Tiger PMC has three logic inputs/outputs available via the LOCK, HOLD, and CAPTURE pins, and three logic I/Os are available for input module use via pins D1, D2 and D3.

More complex I/O intensive applications require an opto-isolated I/O plug-in module, which supports six inputs and up to 16 outputs. This module can connect to an external Breakout Box that is DIN Rail mountable with screw terminal blocks. There are also compatible DIN Rail mounting electromechanical relays and SSR modules.

- 6 Inputs & 16 Outputs or 6 Inputs & 6 Outputs
- Fully Programmable

Connects to DIN Rail terminal block module with 3M IDC cable

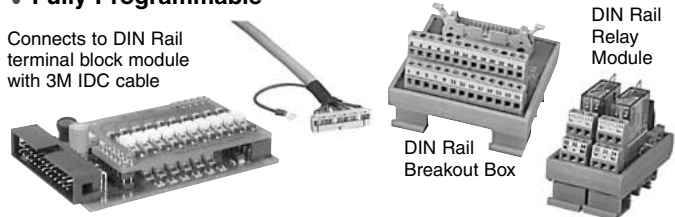

Serial Communication

The easiest way to configure or program a Tiger PMC is with the free user-friendly Configuration or Macro Development Software. Serial I/O is provided via an optional Plug-in output carrier board, which supports RS-232 or RS-485 output modules. If serial I/O is not required by the application, the serial carrier board can be removed for reuse. The Tiger 320 Operating System supports several serial protocols, including ASCII, Modbus RTU and Print Mode (which includes a printer driver and support for direct meter to meter communications). Also supported is DeviceNet, which requires a special dedicated carrier board, and Ethernet (TCP/IP), which requires an external converter box.

DECISION **RS-232 or RS-485**

Except for DeviceNet, all serial communication modes supported by the Tiger can function with either RS-232 or RS-485. The limitations of RS-232 are that only one meter at a time can be connected to the serial port of a computer, and the

distance from the computer to the meter is limited in practical terms to around 30 meters (100 feet).

PLANNING TIP Up to 32 meters can be connected on an RS-485 bus. The differential current drive of the RS-485 bus ensures signal integrity in the most harsh environments to distances up to 1230 meters (4000 feet). However, RS-485 generally requires a special RS-485 output card to be installed in the computer or an external RS-232 to RS-485 converter has to be used.

DECISION **Select the Communication Mode Best Suited to Your Application:**

Modbus (RTU)

Modbus is widely used in industry. It has a large base, and most SCADA and HMI software packages support it. See also Modbus Wrapped in Ethernet (Modbus/TCP) below.



PLANNING TIP There are 100s of HMI Touch Panel Screens that are compatible with the Tiger 320 Modbus interface.

ASCII

The meter configuration utility program and the development software use the ASCII protocol. The ASCII protocol allows you to write your own driver for your own application via the development software and should provide the quickest development time.



Print Mode

This is an ASCII based printer driver output that enables the serial port to be directly connected to any serial printer with Epson compatibility. Printer output can be configured to occur from a setpoint or on demand, and can be date or time stamped.

PLANNING TIP The print mode can also be used for computer data logging applications. The meter can be connected directly to a computer, set up in Microsoft Hyperterminal mode, with the meter programmed to output directly into a Microsoft Excel spreadsheet format. (Also see Data Logging).

Print Mode for Meter to Meter Communication

Two or more Tiger PMCs can be connected together allowing data to be transferred from the master meter (in print mode) to the slave meter (in ASCII mode). This enables the meters to share input data and control output functions.

Master Mode

This mode is for use with macro programming to expand the meter to meter communication capability to multiples of Tiger PMCs. This is useful for building an entire system of Tiger PMCs, sharing information and control output resources.

DECISION **Ethernet**

Ethernet has become a popular automation and control protocol. We supply an ethernet output option and several external ethernet converters that are compatible with the serial outputs of Tiger PMCs.



PLANNING TIP **Ethernet ASCII Wrap** - The ethernet output carrier board option wraps the ASCII output into the Ethernet protocol, and provides a T-base 10/100 Ethernet output socket. This allows the Configuration Utility Program or the Macro Development Software to run over a standard Ethernet network. This enables the Tiger meter to be configured or macro programmed from anywhere in the world via the web.

PLANNING TIP Up to 32 Tiger PMCs can be connected by RS-485 to a single Ethernet Converter, which will support up to 32 separate IP addresses.

PLANNING TIP **Ethernet Modbus Wrap** - This converter accepts the Tiger PMC's modbus protocol and outputs Modbus/TCP through an Ethernet T-base 10 port. This has become a standard for Ethernet on the factory floor. Many SCADA and HMI software packages connect directly to Modbus/TCP.

DeviceNet

DeviceNet was originally developed by Allen Bradley to connect sensors from the factory floor to PLCs. It is a deterministic real-time system, typically used to connect to networks using Allen Bradley PLCs. An optional carrier board is required for DeviceNet which replaces the standard serial output with a dedicated DeviceNet output connector.

Data Logging

The Tiger 320 Operating System has built-in, sophisticated data logging software. Data logging can be triggered from the PROGRAM button, digital inputs, time or alarm functions. Up to 1MB of optional extra on-board memory provides a powerful, multichannel data capture and acquisition system.

PLANNING TIP Tiger PMCs can be configured to log in an endless loop, overwriting the oldest data first and utilizing the maximum amount of memory available. Similar to the Black Box on an aircraft, the data can be downloaded for analysis after a problem event occurs.

PLANNING TIP Data logging can be combined with an Ethernet converter to provide an individual Web Page with data that can be accessed by a browser over the internet.

Real-time Clock

The Tiger meter has an optional real-time clock with a 15 year lithium battery backup, ensuring that time information is not lost in the event of a power failure. It can be configured in 12 or 24-hour modes for printing and data logging applications.

PLANNING TIP Other applications of the real-time clock include activating a setpoint or control action at fixed times of the hour, day, week, month or year.

Flash Card Memory Module

For long term data logging, a Flash Card Memory Module that plugs in to the carrier board output socket is available. Flash Cards are available from 4 to 128 meg. They can be removed and read by a standard card reader, or the data can be downloaded through the serial port or over the internet with an Ethernet converter. The module also has an SSR setpoint output to trigger an external event.

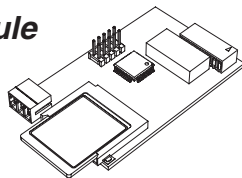

Configuration and Programming with a PC

With a serial output module installed, Tiger 320 PMCs are most easily configured using the Tiger 320 Configuration Utility, which can be downloaded free from the web and run on any Windows-based PC. The utility also enables the user to access some special capabilities of the Tiger 320 which cannot be programmed manually by the front panel buttons.

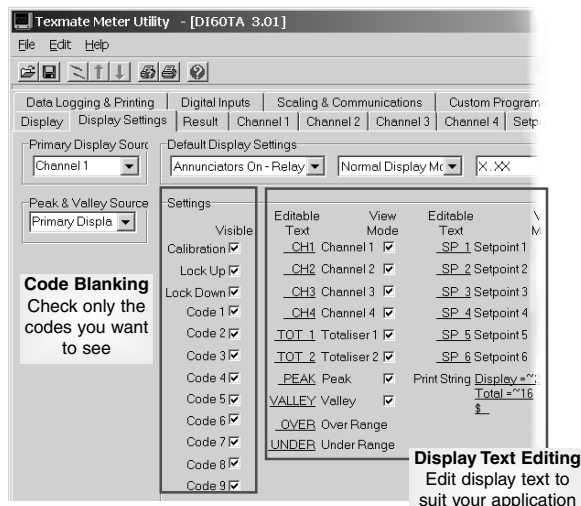

PLANNING TIP The Configuration Utility requires that an RS-232 interface board be installed in a Tiger 320 for programming. However, if the final application does not require a serial output, the RS-232 board can be easily removed, after programming is completed, and kept for future use.

PLANNING TIP When a Tiger 320 is to be used in a custom application, the utility enables all or any of the front panel programming functions to be disabled (code blanking). Customized descriptive text can also be entered to appear with any setpoint action or event.

PLANNING TIP Different configurations can be stored in a PC for fast downloading into a meter by the user. Custom configurations can also be issued a serial number and pre-loaded at the factory.

Development Software

Custom Macro Programming

This powerful, easy to use development system enables programs to be written in BASIC, utilizing any combination of the hundreds of functions and thousands of registers embedded in the Tiger 320 Operating System. When your Basic program is compiled into the Tiger 320 Macro-language it is error checked and optimized. There are also numerous off-the-shelf application specific programs available. Many only need the blanks to be filled in to use them and do not require any knowledge of BASIC programming.

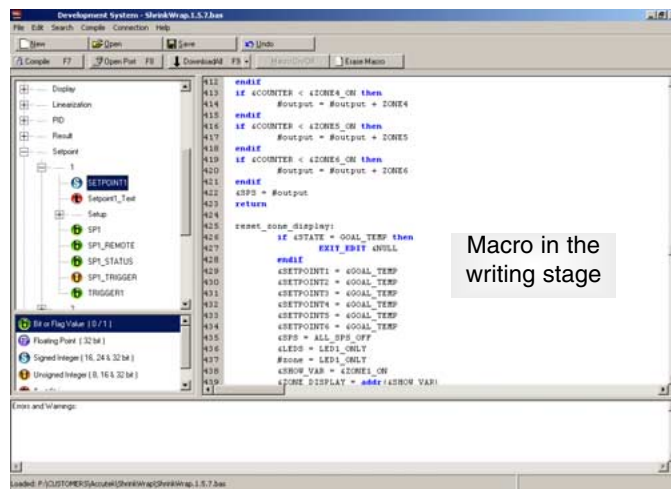

PLANNING TIP Macros are useful when implementing any specialized control system that cannot be achieved by the standard configuration capability of the Tiger 320 Operating System. Using the development software, functions can be altered or added in a standard meter to perform the required job. This may typically include logic sequencing functions and mathematical functions.

PLANNING TIP Developing a Macro is much easier and quicker than programming a PLC, because the basic code required to customize the Tiger meter is considerably less than the ladder logic programming required for PLCs. This is due to the hundreds of functions built into the Tiger meter that can be manipulated or invoked by a macro, to fulfill the requirements of almost any application.

PLANNING TIP Scrolling annunciator messages can be programmed to appear with any setpoint activation, selected events or logic inputs. Easy to read, plain text prompts can be programmed to replace the manual programming codes and provide a user-friendly interface for any custom application.



Block Diagram of the Tiger 320 Software and Hardware Structure

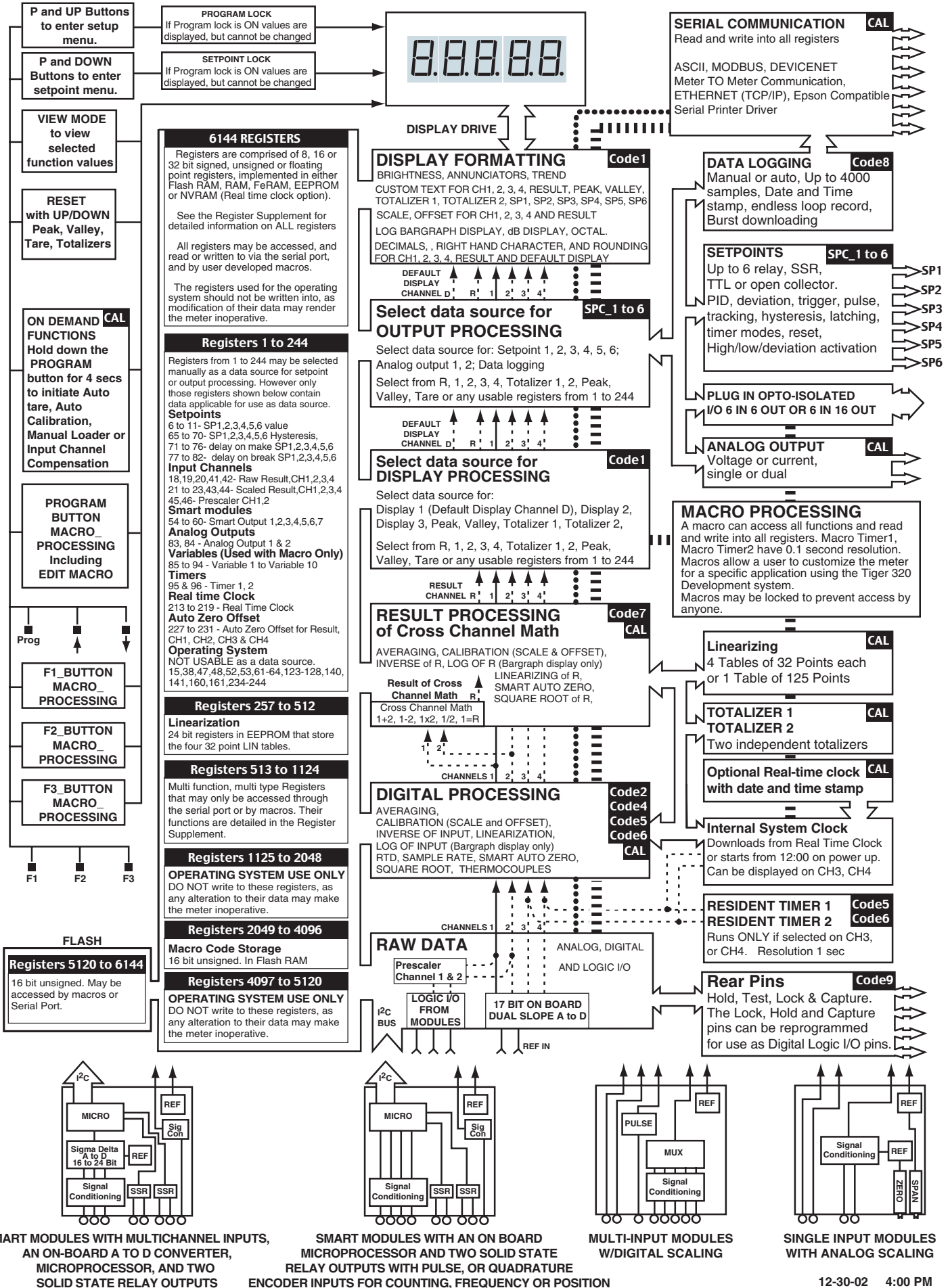

The Easiest and Fastest Way to Configure the Tiger 320 is to Use a PC with the Free Downloadable Configuration Utility Program

The diagrams and instructions provided in this data sheet / user manual are intended to enable the Tiger meter to be configured and programmed manually using the front panel buttons. A system of Programming Codes is required to facilitate this type of manual programming and these are explained in detail with diagrams and examples.

However, when the Tiger meter is configured and programmed via the optional RS-232 serial port and a PC using the Configuration Utility, the system of Programming Codes is bypassed. The Configuration Utility enables all the programming options to be clearly identified by their functions for direct on-screen selection. The Configuration Utility requires that an RS-232 interface board be installed in a Tiger 320 for programming. However, if the final application does not require a serial output, the RS-232 board can be easily removed, after programming is completed, and kept for future use.

The Configuration Utility Program (which may be freely downloaded from the web) is designed to simplify and speed up the configuration and programming of any Tiger 320. Pull down menus facilitate the selection of different options and the assignment of values. A "Help" explanation is provided just by holding the cursor over any function box.

The configuration utility enables the user to access some special capabilities of the Tiger 320 which cannot be selected manually by the front panel buttons.

Source For Display

- OFF
- Primary Display
- Result
- Channel 1
- Channel 2
- Channel 3
- Channel 4
- Totalisator 1
- Totalisator 2
- Peak
- Valley
- Tare
- Setpoint 1
- Setpoint 2
- Setpoint 3
- Setpoint 4
- Setpoint 5
- PID 1
- PID 2
- Register

Source For Peak and Valley

- OFF
- Primary Display
- Result
- Channel 1
- Channel 2
- Channel 3
- Channel 4
- Totalisator 1
- Totalisator 2
- Peak
- Valley
- Tare
- Setpoint 1
- Setpoint 2
- Setpoint 3
- Setpoint 4
- Setpoint 5
- PID 1
- PID 2
- Register

Decimals and Display Format

- No decimal point
- X.X
- X.XXX
- X.XXXX
- X.XXXXX
- External decimal point
- 12 Hour Clock
- 24 Hour Clock
- Hrs : Mins : Secs
- Days : Hrs : Mins
- Octal

Last Digit Rounding

- None
- 2 x
- 5 x
- 10 x

Right Hand Side Character

Annunciators

- Annunciators On - Relay ON
- Annunciators On - Relay OFF
- Annunciators OFF
- Annunciators show tendency

Display Mode

- Normal Display Mode
- Manual Display Mode
- Fast Display Mode

Code Blanking

- Check only the codes you want to see

Display Text Editing

- Edit display text to suit your application

Code Blanking

When a custom configuration is created for any specialized application, the Tiger 320 can be programmed to blank out and disable all or any manual programming codes that you do not wish the user to be able to view or access by de-selecting them in the appropriate check box.

Display Text Editing

The meter can be programmed to display customized text to appear for any setpoint or event to suit any application requirements.

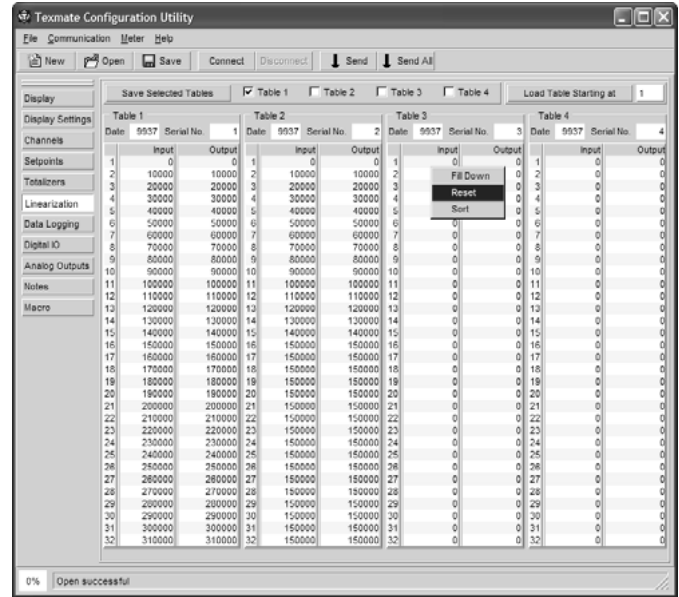

Easy Installation of Linearization Tables

The configuration utility facilitates the storage and downloading of complex linearization tables. Tables can be created in any mathematical or spreadsheet program, and copied into the utility. Linearization tables can be created to precisely match a particular sensor so that they can be installed and downloaded as part of an annual calibration procedure.

Source For Setpoints 1-6

- OFF
- Primary Display
- Result
- Channel 1
- Channel 2
- Channel 3
- Channel 4
- Totalisator 1
- Totalisator 2
- Peak
- Valley
- Tare
- Setpoint 1
- Setpoint 2
- Setpoint 3
- Setpoint 4
- Setpoint 5
- Setpoint 6
- PID 1
- PID 2
- Register

Mode For Setpoints 1-6

- OFF
- Hysteresis
- Deviation
- PID

Timer For Setpoints 1-6

- OFF
- Normal
- One Shot
- Pulse
- Repeat

Latching For Setpoints 1-6

- None
- Latch ON
- Latch OFF

Activation For Setpoints 1-6

- Above
- Below

Reset Mode

- Reset Value
- Constant
- Input-SP+Const.
- Dist+Const.
- Display
- Result
- Channel 1
- Channel 2
- Channel 3
- Channel 4
- Totalisator 1
- Totalisator 2
- Peak
- Valley
- Tare
- Setpoint 1
- PID 1
- PID 2
- Register

Easy Setpoint Configuration

The Tiger 320 supports an incredible range of setpoint options and functions. The utility makes it quick and easy to select and download any combination you may require.

Configuration Data Copying and Loading

The configuration utility program allows you to store a record of a meter's configuration for later referral, or for the restoration of a desired configuration. Macros can be combined with a configuration file so they can be downloaded together and locked at the same time. When a file is locked after downloading, it cannot be copied. It can only be erased and reloaded from a master file.

Also included is the ability for the user to make notes about the configuration that can be stored as part of the file.

Never Before has the Customization of such a Powerful Measurement, Control and Automation Product been Made so Fast, Free and Easy

The Tiger 320 Macro Development System is so power packed and feature rich that you can build a completely custom designed controller in 1/50th of the time it would take to program a microprocessor or a PC, and 1/20th of the time it can take to program a PLC.

Quickly convert any special metering or control and automation idea into your own proprietary product, CE approved and ready to ship in days, with custom multicolor faceplates, labels, shipping boxes and instruction manuals.

This powerful, easy to use Development System can be downloaded free from the web. It enables programs to be written in BASIC, which can utilize any combination of the hundreds of functions and thousands of registers embedded in the Tiger 320 Operating System.

When your BASIC program is compiled into the Tiger 320 Macro-language it is error checked and optimized. When your Macro is downloaded into a Tiger 320 and locked, it is locked forever. It cannot be read or duplicated, it can only be erased. There is no back-door access. A Tiger 320 running your Macro will remain your exclusive proprietary product.

There is also a growing library of off-the-shelf application specific macro programs available. Many only need the blanks to be filled in to use them and this does not require any knowledge of BASIC. The source code is provided with these programs so they can easily be customized and/or integrated into any proprietary application-specific Macro.

On request, any custom Macro can be issued a serial number and pre-installed at the factory to operate on power-up.



Scrolling annunciator messages can be programmed to appear with any setpoint activation, selected events or logic inputs. Easy to read, plain text prompts can be programmed to replace the manual programming codes and provide a user-friendly interface for any custom application.

Tiger Development System - Code Writing Screen

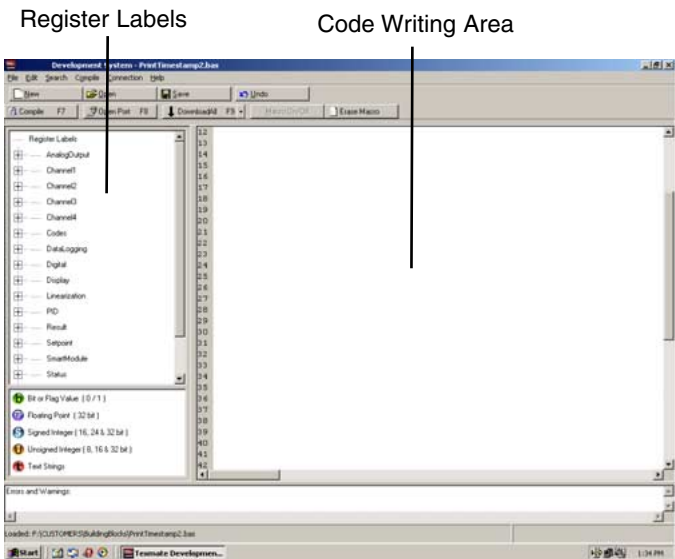

Tiger Development System screen showing Macro being written.

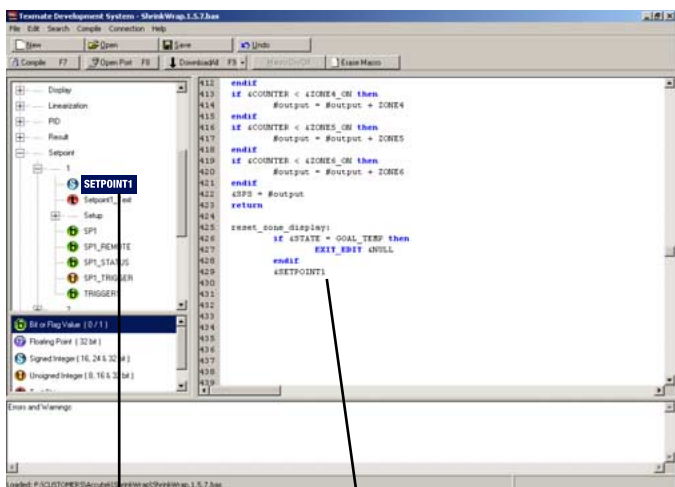

Double clicking on register label in the left hand side frame automatically inserts the function in the code window at the cursor insertion point.

Tiger Development System screen showing the Macro code being compiled successfully.

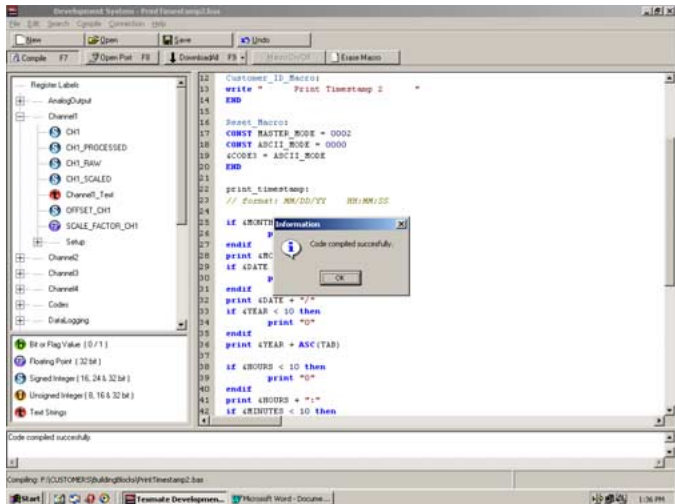

Tiger Development System screen showing the compiled Macro being downloaded into a Tiger 320 Series PMC.

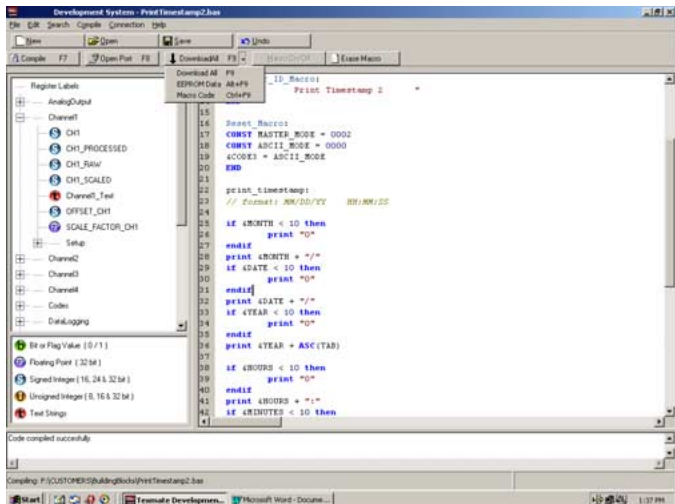

32-Bit Operating System	4	Code 9 - Functions for Digital Input Pins	37
Analog Output / Analog Retransmission	21-22	Code Blanking	19-20
Calibration of Analog Output.....	21	Clock/Timer	
Dual (0-10V) Analog Output	21	Configuration.....	31, 34, 35
Location of Analog Output Module	47	Optional Real-time Clock	4
Pinout of Analog Output	46	Real-time Clock Configuration	31, 34, 35
Scaling of Analog Output	21, 22	Real-time Clock Date	37
Select Source for Analog Output	21	Time Stamp.....	37
Auto Zero Maintenance for Weighing Applications	22	Component Layout & External Devices	47-48
Set Parameters for CH1, CH2, CH3 & CH4	21	Modular Construction	47
Averaging - Digital Filtering	22	Component Layout	48
Set Parameters for CH1, CH2, CH3 & CH4	21	Configuration and Programming from a PC	4, 8
Block Diagram of Software & Hardware	9	Configuration Utility Program	
Brightness Display	20	Code Blanking and Display Text Editing	10
Calibration	21-24	Configuration Data Copying	10
Calibration Thermocouple or RTD	21	Installation of Linearization Tables	10
Manual Calibration	23	Setpoint Configuration	10
Single-Point Calibration.....	23	Connections	
Two-Point Calibration	23	Carrier Board Output Pinouts	46
Case Dimensions	60	Connector Pinouts	45
Modular Construction	47	External Devices	48
Other Case Sizes	3, 4	Ordering Information, Connectors	58
Channel 1 Settings	31-32	Rear Panel Pinout Diagram	45
32 Point Linearization	32	Controls & Indicators	14-15
Analog Input Signal Sample Rate.....	31	Annunciator LEDs.....	14
Counter/Resident Timer/Clock	31	Down Button	14
Measurement Task	31	Error Message	15
Post Processing	32	LED Display	14
Print Mode.....	32	Program Button.....	14
Sampling Rate	31	Program Lockout Switch.....	15
Serial Mode.....	32	Scrolling Display Text Messaging	14
Smart Input Module	31	Setpoint Lockout Switch	15
Channel 2 Settings	33	Seven Segment LED Displays	14
Channel 3 Settings	34	Up Button	14
Channel 4 Settings	35	Control Outputs	6-7
Channel 1 & Channel 2 Results Processing		Electromechanical Relays	
32 Point Linearization	36	or Solid State Control Outputs	6
Maths Functions	36	I/O Logic, Rear Panel or Breakout Box.....	7
Code 1 - Display Configuration	25-30	PID or ON/OFF Control	7
Configure Data Source Procedure	27	Retransmission 0-10V or 4-20mA.....	7
Configure Display Format Mode Procedure	28	Custom Macro Programming	
Configure Last Digit Text Char. Procedure	29	Macro Compiling and Loading	11
Configure Setpoint Annunciators Procedure	30	Data Logging	4, 8, 37
Configure Update at Sample Rate Procedure	30	Downloading Logged Data from Meter.....	37
Data Source - 2nd Digit [X5X]	25	Flash Card Memory Module	8
Display Format - 2nd Digit [X6X]	25	Printing Logged Data	37
Display Functions Mode	25	Real-time Clock.....	8, 37
Manual Loader Mode	25	Development Software	
Setpoint Annunciators Mode.....	25	When to Use Macros	8
Text Character - 2nd Digit [X7X].....	25	Digital Input Pins	37
Update Display at Selected Sample Rate.....	25	Display Brightness Setting	20
Code 2 - Channel 1 Measurement Task		Display Functions	25-30
and Sampling Rate	31	Data Source	27
Code 3 - Channel 1 Post Processing		Display Format and Decimals.....	28
and Serial Mode Functions	32	Display Rounding	28
Code 4 - Channel 2 Measurement Task		Last Digit Text Character.....	29
and Sampling Rate	33	Other Display Formats	4
Code 5 - Channel 3 Functions	34	Setpoint Annunciator Mode.....	30
Code 6 - Channel 4 Functions	35	Update at Sample Rate	30
Code 7 - Result Processing	36	Display Options	
Code 8 - Data Logging & Print Mode	37	LED or LCD Displays	6

Numeric or Alphanumeric Displays.....	6	Power Supply	5, 45
Push Button or Membrane Touch Pads	6	Prescaling	
Remote Display.....	6	Channel 1	31
Single or Multiple Displays	6	Channel 2	33
Faceplates		Print Mode	7, 32
Custom Faceplates	59	Programming Codes	17-18
Optional Caption Sheets	59	Programming Conventions	16
Custom Faceplate Design Template	59	Programming via PC	4, 10-11
Filtering		Registers	
<i>See Averaging Samples & Averaging Window</i>		Registers That Can Be Selected	44
Front Panel Controls	4, 14-15	Registers That Should Not Be Selected	44
Front Panel Programming Codes	17-18	Resetting and Incrementing Using Setpoints	44
Main Programming Mode	17	Relay & Logic Output Modules	46
On Demand Modes.....	18	Serial Communication	5, 7-8
Setpoint Programming Mode	17	ASCII.....	7
View Modes	18	Configuration.....	32
Functional Diagram	45	DeviceNet	8
General Features	1	Ethernet	7
HMI Touch Panel Graphic Displays	7	Master Mode.....	7
Hysteresis and Deviation	39-40, 42	Modbus	7
Initial Setup Procedures	19-20	Pinouts	46
Code Blanking and Macro Check	19-20	Print Mode.....	7
Model and Software Code Version Check	19	RS-232 or RS-485	7
Input Signal Conditioning Modules	5, 49-55	Setpoint Programming Mode	38-43
Input Module Component Glossary	55	Data Logging.....	39
Input Module Index	49	Data Printing to PC.....	39
Input Modules	50-54	Data Printing to Serial Printer.....	39
Modular Position	47	Display Flashing	39
Ordering Information, Input Modules	56-57	Hysteresis or Deviation.....	39-40, 42
Input Signals & Sensors		Level 1 - Basic Mode - Prog. Procedures	41
4-20mA or Sensor Direct	6	PID Control Settings	39, 42
Sensor Linearization or Compensation.....	6	Real-time Clock Option	39
I/Os (Opto Isolated & Logic Ports)	5, 48	Relay Time Control Modes	40
Linearization		Relay Energize Functions	39
Channel 1 Temperature Sensors	31	Relay Output Modules	38
Channel 1 User Loaded Tables.....	32	Setpoint & Relay Control Settings	38, 42
Channel 2 Temperature Sensors		Setpoint Activation Source	39
and User Loaded Tables	33	Setpoint Activation Values.....	38
Channel 3 Temperature Sensors		Setpoint Latching	39
and User Loaded Tables	34	Setpoint Reset & Trigger.....	39, 43
Channel 4 Temperature Sensors		Setpoint Tracking.....	39
and User Loaded Tables	35	Timer Modes	39, 43
Result of CH1 & CH2 User Loaded Tables.....	36	Smart Input Modules	
Table Settings	22, 36	Setting Up	31
Literature Overview		Supplements	
Model Specific Data Sheets / User Manuals	3	<i>See Literature Overview</i>	
Other Tiger 320 Series Related Software.....	3	Table of Contents	1
Programming Code Sheet	3	Timers	5, 39
Supplements to Data Sheets / User Manuals.....	3	Configuration.....	31, 34, 35
Macros	4, 8, 11	Delay Settings.....	43
Macro Check.....	19-20	Modes	40
Manual Loader	25	Totalizers	
Maths Function		Setting.....	21-22
Cross Channel Maths	9, 36		
Result Processing.....	36		
Modbus	7, 22		
Model Type Check	19		
On Demand Functions	21		
Ordering Information	56-58		
Panel Cutout	60		
PID Control Settings	39, 42		

Front Panel Controls and Indicators

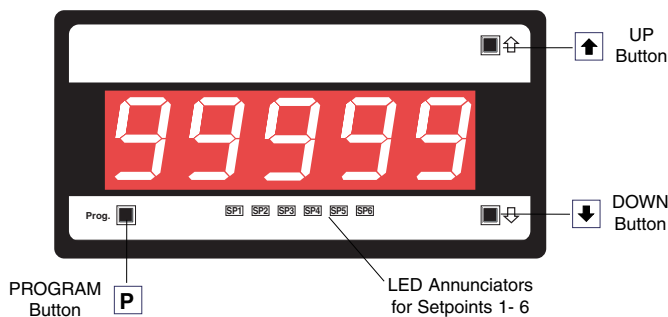

Display with Faceplate and Bezel

Optional Membrane Touch Pad Faceplate

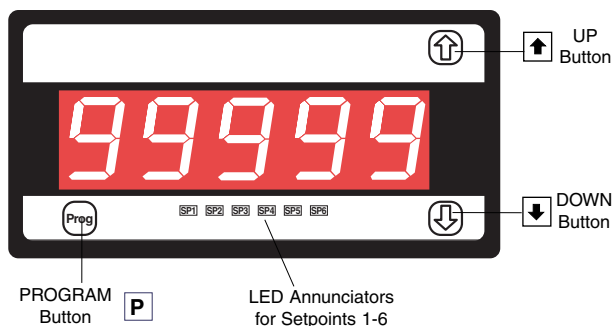

Display with Faceplate and Bezel

Program Button

While programming, pressing the **[P]** button saves the current programming settings and moves to the next programming step.

You can move through the programming codes using the program button. The codes you pass are not affected, unless you stop and make changes using the **[↑]** or **[↓]** buttons.

Pressing the **[P]** and **[↑]** button at the same time initiates the **main programming mode**. To save a new configuration setting and return to the operational display, press the **[P]** button once and then press the **[P]** and **[↑]** button at the same time.

Pressing the **[P]** and **[↓]** button at the same time initiates the **setpoint programming mode**. To save a new configuration setting and return to the operational display, press the **[P]** button once and then press the **[P]** and **[↓]** button at the same time.

See *Display with Faceplate and Bezel diagram*.

Up Button

When setting a displayed parameter during programming, press the **[↑]** button to increase the value of the displayed parameter.

When in the operational display, pressing the **[↑]** button initiates a viewing mode that allows you to view the readings on **channels 1 and 3, setpoints 1, 3, and 5, peak, and total 1**. Once into the viewing routine, pressing the **[↑]** button moves through each displayed parameter.

See *Display with Faceplate and Bezel diagram*.

Down Button

When setting a displayed parameter during programming, press the **[↓]** button to decrease the value of the displayed parameter.

When in the operational display, pressing the **[↓]** button initiates a viewing mode that allows you to view the readings on **channels 2 and 4, setpoints 2, 4, and 6, valley, and total 2**. Once into the viewing routine, pressing the **[↓]** button moves through each displayed parameter.

See *Display with Faceplate and Bezel diagram*.

Annunciator LEDs

The annunciator LEDs can be programmed to indicate the alarm status.

Setpoint 1 can be configured to indicate the **rising** signal trend. Setpoint 2 can be configured to indicate the **falling** signal trend. They are labeled from left to right: SP1, SP2, SP3, SP4, SP5, SP6.

See *Display with Faceplate and Bezel diagram*.

Seven Segment LED Displays

The five, seven segment LED displays are used to display the meter input signal readings.

They also display the programming codes and settings during programming. The display is available in red, green, or super bright red LEDs.

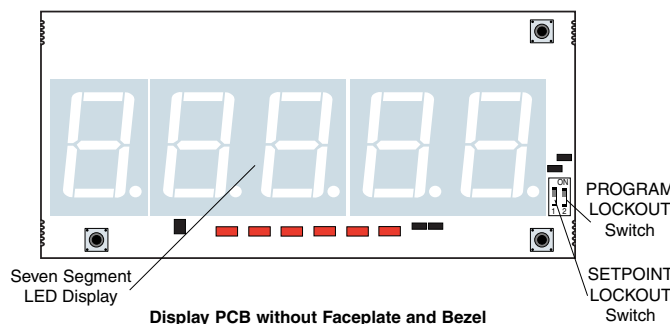

Display PCB without Faceplate and Bezel

LED Display

The meter has a 5-digit, 7-segment, 1" (25.4 mm) standard red, or optional green or superbright red LED numeric display. The LED displays are used to display the meter input signal readings. They also display the programming codes and settings during meter programming.

Display Text Editing with 7 Segment Alphanumeric Display Characters

Display text, such as setpoints, can be easily edited to suit your application, by connecting the meter to a PC running the free downloadable Configuration Utility program.

For Example:

Instead of [SP_1]

Instead of [SP_2]



OR



could be used for TANK LOW

could be used for BRAKE OFF

Scrolling Display Text Messaging

Scrolling display text messaging can be configured to run with a simple macro.



Display Text Characters

The following text characters are used with the 7-segment display.

7-SEGMENT DISPLAY CHARACTERS

1	2	3	4	5	6	7	8	9	0
A	b	c	d	E	F	G	h	i	U
e	L	n	7	n	o	P	a	r	S
t	U	U	U	U	3	4	2		

Program Lockout Switch

When the PROGRAM LOCKOUT switch is set to position 2, all programmable meter functions can be changed.

When set to the ON position, the PROGRAM LOCKOUT switch prevents any programming changes being made to the meter. If programming is attempted, the meter displays [LoC]. The ON position allows programming parameters to be viewed but not changed.

See *Display PCB without Faceplate and Bezel diagram*.

Setpoint Lockout Switch

When the SETPOINT LOCKOUT switch is set to position 1, the setpoints can be programmed. Once the setpoint values have been entered and the SETPOINT LOCKOUT switch set to the ON position, the setpoints can be viewed but not changed.

See *Display PCB without Faceplate and Bezel diagram*.

Error Message [Err]

Error messages usually occur during calibration procedures. The three most likely causes of an error message are:



Display Showing Error Message

- 1) The full scale and zero signals were too similar.
Note, the high input (full scale) signal must be at least 1000 counts greater than the low input (zero) signal (positive and negative values are allowed).
- 2) The scaling requirement exceeded the capability of the meter (-19999 to +99999).
- 3) No input signal present, or incorrect connections.

Rear Panel External Switched Inputs

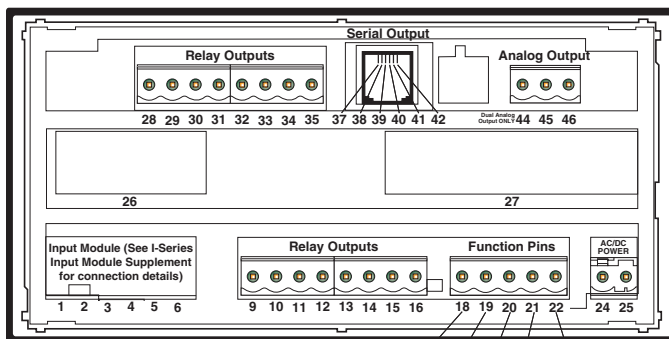

Rear Panel

Lock Pin

By configuring Code 9 to [XX0], connecting the LOCK pin (pin 18 on the main PCB) to the COMMON pin (pin 21 on the main PCB), both the main and setpoint programming modes are locked out. All meter programming codes and setpoints can be viewed but not changed.



Display Showing [LoCK] Message

The main programming mode can be entered, but only the brightness setting adjusted. After adjusting the brightness setting, pressing the **[P]** button displays [LoCK].

The LOCK pin can also be configured in Code 9 to carry out the following functions (see *Meter Programming Codes* on Page 17):

- Reset channel 1 [XX1].
- Reset channel 2 [XX2].
- Reset channel 3 [XX3].
- Reset channel 4 [XX4].
- Reset tare [XX5].
- Reset total 1 [XX6].
- Unlatch (de-energize) all setpoints [XX7].

Hold Pin

Configure Code 9 to [X0X]. When the HOLD pin (pin 19) is connected to the COMMON pin (pin 21) the displayed reading is frozen. However, A/D conversions and all control functions continue and as soon as pin 19 is disconnected from pin 21 by the switch, the updated reading is instantly displayed.

The HOLD pin can also be configured in Code 9 to carry out the following functions (see *Meter Programming Codes* on Page 17):

- Reset channel 1 [X1X].
- Reset total 1 and total 2 [X2X].
- Reset total 2 [X3X].
- Reset peak and valley [X4X].
- Reset tare [X5X].
- Set tare [X6X].
- Unlatch (de-energize) all setpoints [X7X].

Test Pin

Configure Code 9 to [0XX]. When the TEST pin (pin 20) is connected briefly to the COMMON pin (pin 21) all segments of the display and setpoint annunciators light up. Five eights and five decimal points (8.8.8.8.8.) are displayed for a short period. The microprocessor is also reset during this time, losing all RAM settings such as peak and valley, and any digital input pin settings set up in Code 9.

The TEST pin can also be configured in Code 9 to carry out the following (see *Meter Programming Codes* on Page 17):

- Reset counter channel 1 and total 2 at power-up [1XX].
- Reset counters, CH1, CH2, CH3, CH4, total 1, and total 2 at power-up [2XX].
- Reset total 1 and total 2 at power-up [3XX].

Capture Pin

When the CAPTURE pin (pin 22) is connected to the COMMON pin (pin 21), the CAPTURE pin can be programmed for setpoint/relay activation or macro control applications in the setpoint control settings mode of the setpoint programming mode [SPC_X] [X2X].

Common Pin

To activate the LOCK, HOLD, TEST and CAPTURE pins from the rear of the meter, the respective pins have to be connected to the COMMON pin (pin 21).

Front Panel Push Button Configuration and Setup for Programming Conventions

The meter uses a set of intuitive software codes to allow maximum user flexibility while maintaining an easy programming process. To configure the meter's programming codes, the meter uses the three right-hand side display digits. These are known as the 1st, 2nd, and 3rd digits and can be seen in the diagram opposite.

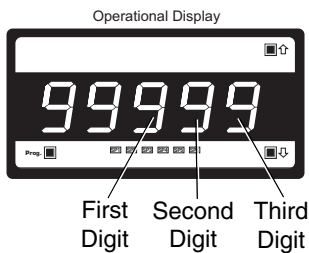

To explain software programming procedures, diagrams are used to visually describe the programming steps. The following conventions are used throughout the range of Tiger 320 Series document diagrams to represent the buttons and indicators on the meter, and the actions involved in programming the meter:

Symbol

Explanation



The display showing 99999 represents the **OPERATIONAL DISPLAY**. After the meter has been powered up, the display settles and indicates the calibrated input signal. This is known as the operational mode and is generally referred to as the operational display throughout the documentation.

All programming modes are entered from this level.



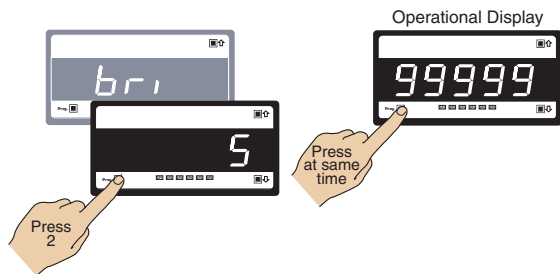

This symbol represents the **PROGRAM** button. In a procedure, pressing the program button is always indicated by a **left hand**. A number indicates how many times it must be pressed and released, or for how long it must be pressed before releasing.



This symbol represents the **UP** button. Shown in a diagram, pressing the UP button is always indicated by a **right hand**.



This symbol represents the **DOWN** button. Shown in a diagram, pressing the DOWN button is always indicated by a **right hand**.

Where two right hands are shown on the same diagram with the word OR between them, this indicates that both the  and  buttons can be used to adjust the display: UP for increase, DOWN for decrease.

[Span]
[10000]



Text or numbers shown between square brackets in a description or procedure indicate the programming code name of the function or the value displayed on the meter display.

Programming procedures are graphic based with little descriptive text.

Each procedure shows a number of meter panel displays running in procedural steps from the top to the bottom of the page.

If need be, the procedure may run into two columns with the left column running down the page and continuing at the top of the right-hand column. Each action performed by the user is shown as a numbered step.

Each procedural step shows the meter display as it looks before an action is performed. The hand or hands in the procedural step indicate the action to be performed and also how many times, or for how long, the button is to be pressed.

For example, the diagram below shows the meter in the operational display. With a left hand pressing the  button and a right hand pressing the  button, the user is entering the **main programming mode**. This is indicated by the next diagram displaying [br1] and [5]. This is the display brightness mode and is the first sub-menu of the main programming mode.

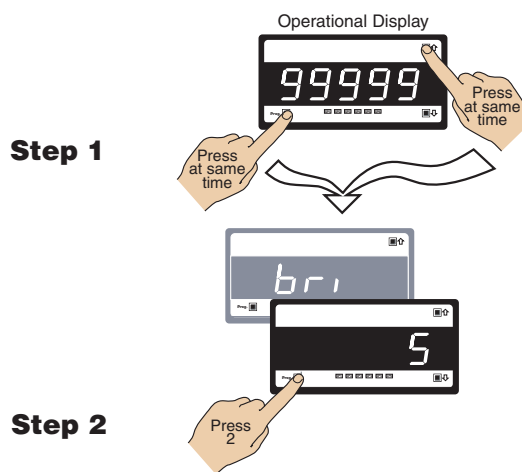

Where a left and right hand are shown on separate buttons on the same diagram, this indicates that the buttons must be pressed at the same time.

The exceptions to this rule are when carrying out the *Model and Software Code Version Check*, or the *Code Blanking and Macro Check*.

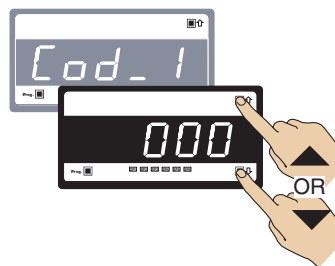

When two displays are shown together as black on grey, this indicates that the display is toggling (flashing) between the name of the function and the value or configuration setting.

Where a number is not definable, the default setting [000] is shown.



If an X appears in the description of a 3-digit programming code or in a configuration procedure, this means that any number displayed in that digit is not relevant to the function being explained, or more than one choice can be made.

Front Panel Programming Codes

The meter's programming codes are divided into two modes: the **main programming mode**, and the **setpoint programming mode**. (See diagram below). Each mode is accessible from the operational display.

Main Programming Mode

The main programming mode provides access to program all meter functions, except setpoints.

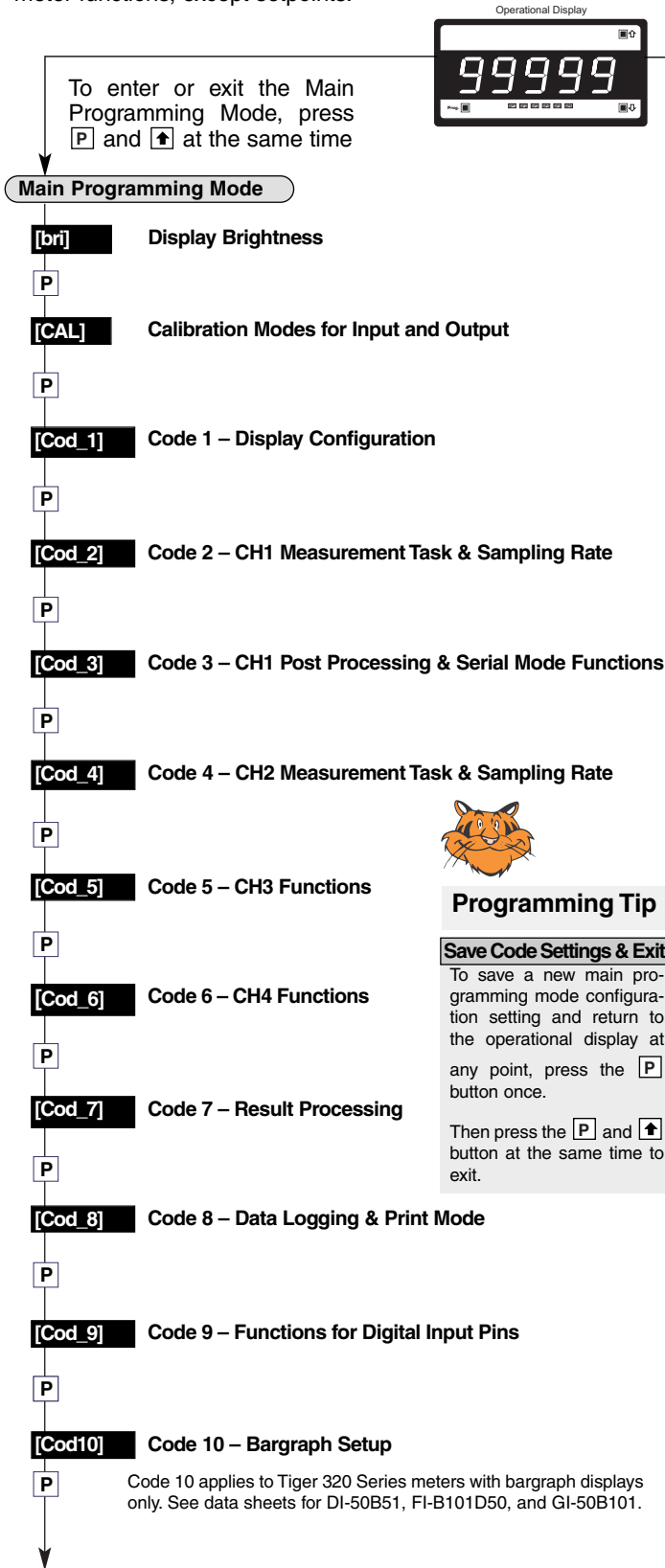

Programming Tip

The easiest and fastest way to configure the Tiger 320 is to use a PC with the free downloadable configuration utility program. (see page 10)

Setpoint Programming Mode

The setpoint programming mode provides access to program all setpoint and relay functions.

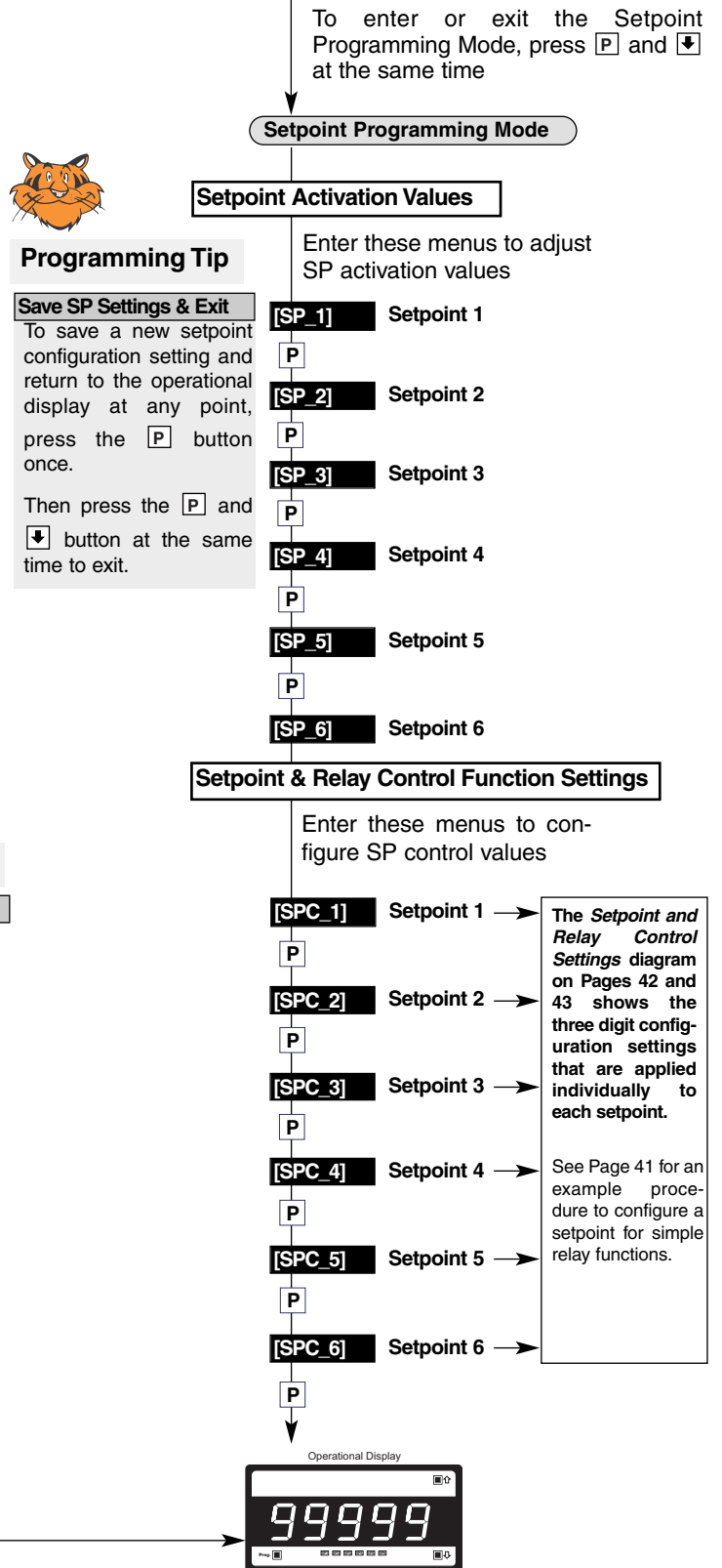

View Modes

While in the operational display, pressing the  button allows you to view but not change the following parameters:

- Channel 1.
- Channel 3.
- Setpoint 1.
- Setpoint 3.
- Setpoint 5.
- Peak (of CH1).
- Total 1 (total of CH1).

While in the operational display, pressing the  button allows you to view but not change the following parameters:

- Channel 2.
- Channel 4.
- Setpoint 2.
- Setpoint 4.
- Setpoint 6.
- Valley (of CH1).
- Total 2 (total of CH2).

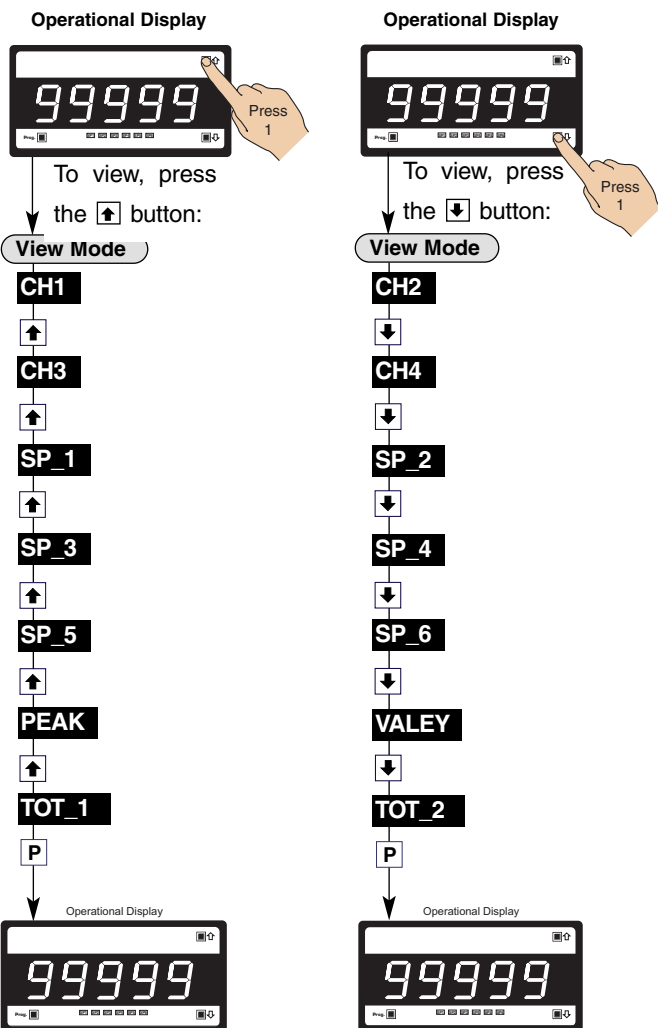



On Demand Modes

The meter can be programmed to activate the following functions on demand by pressing the  button for 4 seconds:

- Tare.
- Single-point calibration.
- Two-point calibration.
- Primary input compensation.
- Manual loader (manual offset).
- Print.

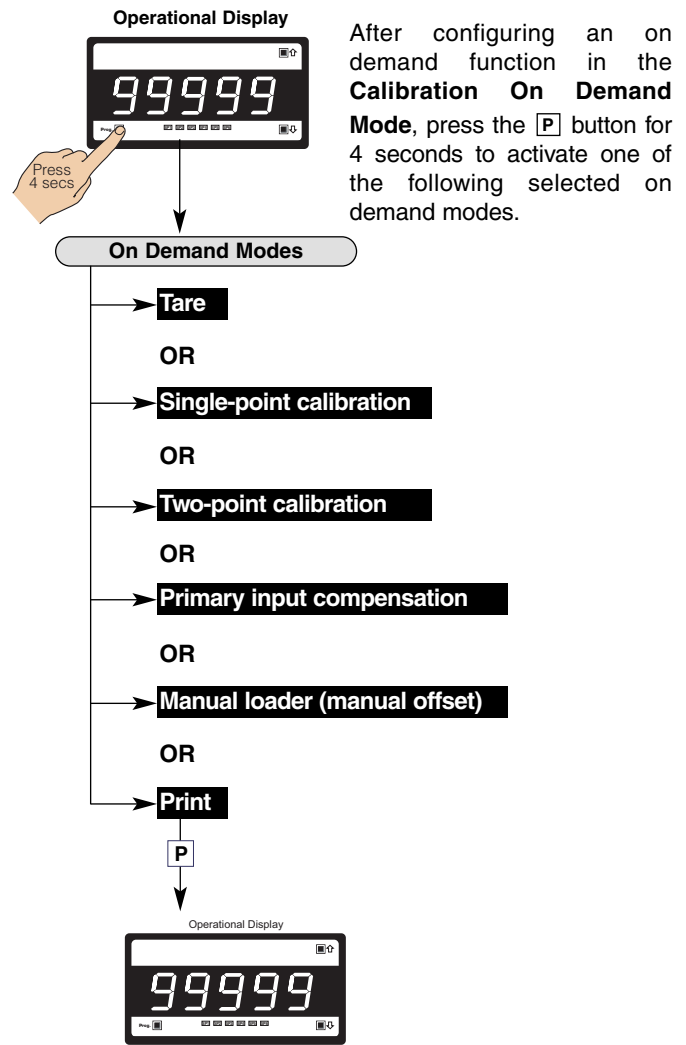
The on demand function is selected in the calibration mode.



After configuring an on demand function in the **Calibration On Demand Mode**, press the  button for 4 seconds to activate one of the following selected on demand modes.

For a full breakdown of all programming codes, see the *Tiger 320 Series Programming Code Sheet (NZ101)*. See page 3 for more information.

Initial Setup Procedures

Before configuring the meter, carry out the following meter configuration checks:

- Model and software code version check.
- Code blanking and macro check.

After powering-up the meter, check the model and software code version number and note this in your user manual.

Model and Software Code Version Check

The meter model and software code version number can be checked at any time while in the operational display using the following procedure.

START HERE

MODEL & SOFTWARE CODE VERSION CHECK

Step 1

Press and hold the and buttons

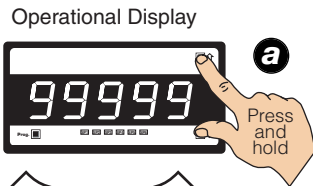

Step 2

While holding both buttons, press the Prog. button then release all three buttons

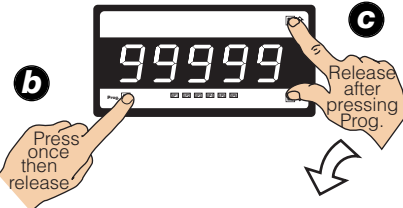

Step 3

The above displays toggles three times before returning to the operational display



Model No:
 Software Version No:
 Customer ID:
 Macro ID:



Programming Tip

The Model and Software Code Version checking procedure can be performed at any time without interfering with other configuration settings.

Code Blanking and Macro Check

Tiger 320 Series meters have the ability to hide (blank out) all or some programming codes, making them tamper-proof. This can only be done using the Meter Configuration program.

With code blanking turned ON, all main and setpoint codes that have been blanked out during factory programming are hidden, preventing them from being reprogrammed. Any codes that have not been blanked out are still visible and can be reprogrammed.

Turning code blanking OFF means all meter programming codes are visible when you enter the programming modes and can be reprogrammed.

A macro is a set of commands that run automatically when the meter is powered up. The supplier has a growing library of macros to suit a wide range of standard customer applications.

Macros can be installed in the meter at the factory during initial programming or by the customer at some later date. Macros are written and compiled using the BASIC Compiler program, and loaded into the meter using either the BASIC Compiler program or the Meter Configuration program.

Turning the macro OFF means that the meter will not perform the automatic commands pre-programmed to run with the macro.

Unless requested to blank out all or some programming codes and/or run a macro, the supplier programs the meter in the code blanking OFF and macro OFF (default) setting.

To turn the code blanking and macro settings from ON to OFF:

START HERE

CODE BLANKING & MACRO CHECK PROCEDURE

Step 1

Press and hold the and buttons

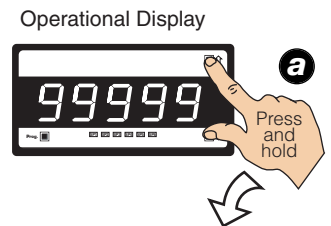

Step 2

While holding both buttons, press the Prog. button.

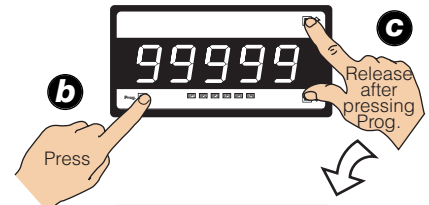

Step 3

Release the the and buttons and hold the Prog. button for approx. 1 sec then release



Example Code Blanking

NOTE: Unless otherwise requested, the factory default setting is OFF

Step 4

Press the button to switch code blanking OFF



Code Blanking & Macro Check Procedure

continued on next page (Step 5)

Initial Setup Procedures continued

continued from Step 4

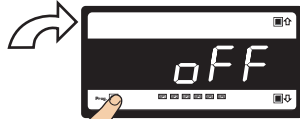

Step 5

Press the Prog. button.



Example



NOTE: Unless otherwise requested, the factory default setting is OFF

Step 6

Press the button to switch the macro OFF



Step 7

Press the Prog. button.



Operational Display



Programming Tip

Code Blanking and Macro ON/OFF settings revert to the meter's original configuration settings when the meter is powered off and on.

[bri] - Display Brightness

Display Configuration

Once you have read the User manual and related supplements, and installed and powered-up the meter, configure the display to suit its designated application.

Display Brightness Mode

The **display brightness mode** is accessed when entering the main programming mode. It allows you to adjust the brightness of the display LEDs and setpoint annunciators without interfering with other configuration settings. It is always available, even with the PROGRAM LOCK switch set to ON, or the external LOCK pin connected to the COMMON pin, locking out the programming modes.

The display brightness can be set between 0 and 7, with 0 being dull and 7 being bright. 5 is the default setting.

Example Procedure:

Configure the display brightness setting to 7 (bright).

START HERE

DISPLAY BRIGHTNESS MODE

Step 1

Enter Brightness Mode

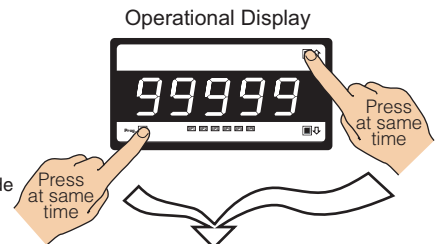

Step 2

Adjust brightness to 7

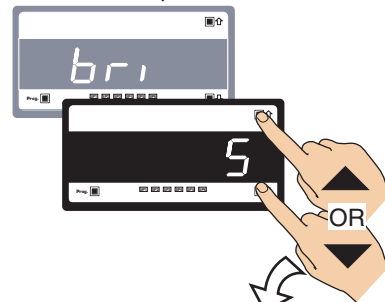

Step 3

Save brightness setting. Exit Brightness Mode. Return to Operational Display

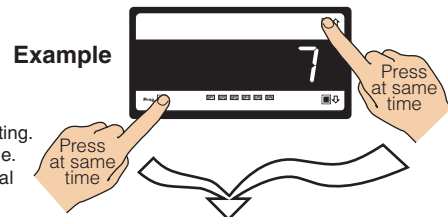

Operational Display



Programming Tip

The *Display Brightness* setting procedure can be performed at any time without interfering with other configuration settings by entering the main programming mode.

[CAL] - Calibration Modes for Input and Output

The Tiger 320 Series meter has an extremely powerful set of input and output calibration modes. See diagram below.

ON DEMAND Functions

In this mode the meter can be programmed to activate one of the following on demand functions by pressing the **P** button while in the operational display:

- On Demand TARE.
- On Demand Single-point Calibration (requires single input source).
- On Demand Two-point Calibration (requires dual input source).
- On Demand Primary Input Compensation Mode.
- On Demand Manual Loader Mode.

Calibration Modes

The following calibration modes are available:

- Manual Calibration (requires NO input source).
- **Two-point Calibration (requires dual input source).**
This is the calibration mode generally used to calibrate the meter for most applications. An example procedure has been included.
- Calibrate Thermocouple (requires K type thermocouple input source).
- Calibrate RTD (requires RTD 385 input source).
- Calibrate Smart Input Module (not available on all input modules).
- Calibrate Analog Output (requires multimeter connected to pins 16 and 17).

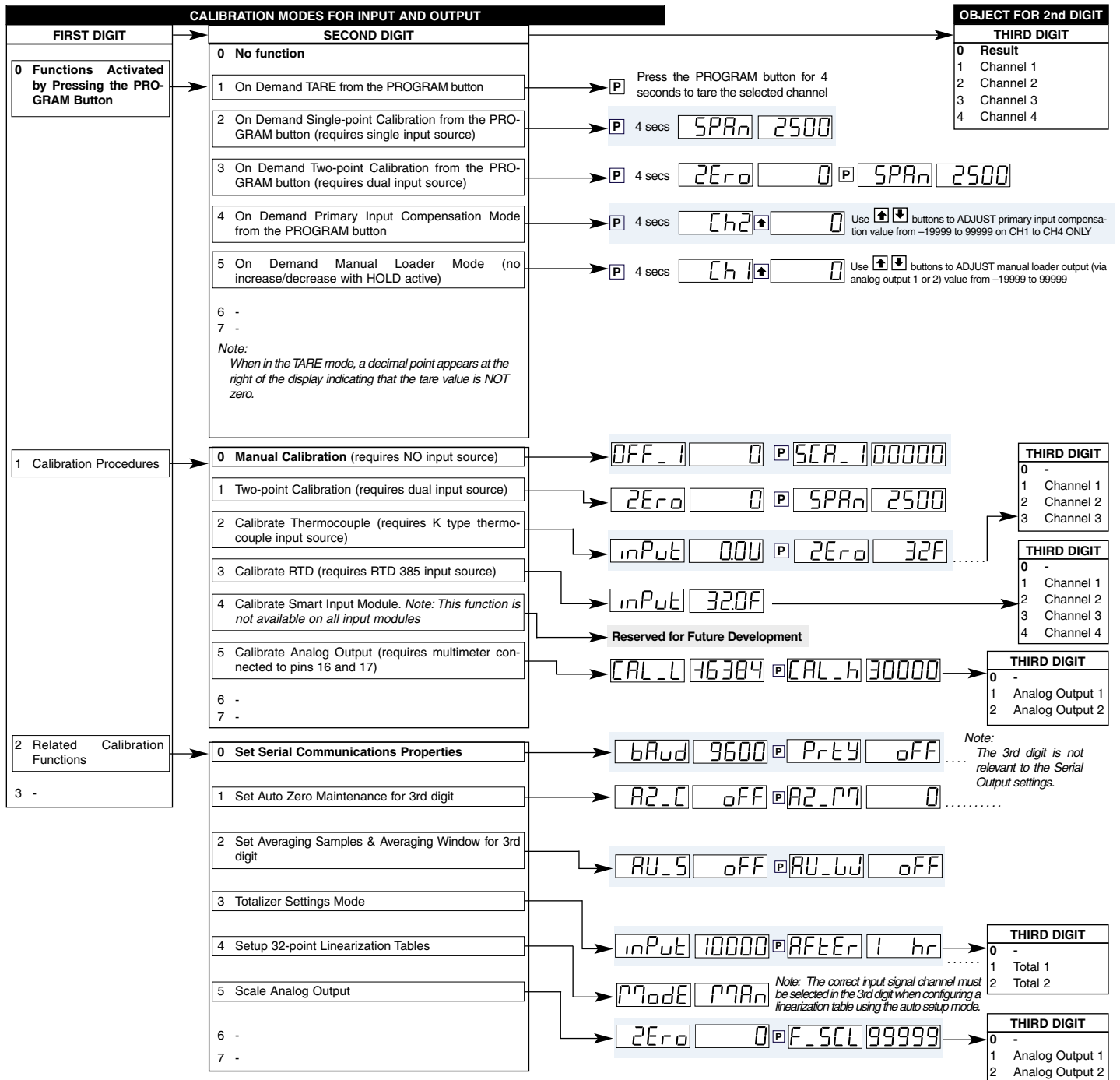

Related Calibration Functions

The following functions are also configured in the calibration mode. See *Advanced Calibration and On Demand Mode Supplement (NZ203)* for further calibration details. (See page 3 for more information).

Serial Communications Properties

Selecting [CAL][20X] enters the Serial Communications Properties Mode.

This mode allows you to configure the serial communications output module baud rate, parity, time delay, and address settings.

See the *calibration modes* diagram on Page 21 showing a breakdown of 1st, 2nd, and 3rd digits.

Also see the *Serial Communications Module Supplement (NZ202)* for further details on the serial communications module. (See page 3 for more information).

Set Auto Zero Maintenance

Selecting [CAL][21X] enters the Set Auto Zero Maintenance Mode.

This mode allows you to configure auto zero maintenance settings for weighing applications applied to the channel selected in the 3rd digit.

See the *calibration modes* diagram on Page 21 showing a breakdown of 1st, 2nd, and 3rd digits.

Set Averaging Samples & Averaging Window

Selecting [CAL][22X] enters the Set Averaging Samples and Averaging Windows Mode.

This mode allows you to configure the number of input signal samples to average over, and the size of the averaging window in display counts applied to the channel selected in the 3rd digit.

Selecting [CAL][22X] enters the Set Averaging Samples and Averaging Windows Mode. When in this mode, the [AV_S] menu allows you to select the number of input signal samples to average over. After setting the number of samples, moving to the [AV_W] menu allows you to configure the size of the averaging window in displayed counts.

The meter averages the input samples over the selected number of input samples (selected in the [AV_S] menu). This carries on in a continual process provided the input signal stays within the averaging window (set in the [AV_W] menu). If the sample moves out of the averaging window, the meter responds quickly to the change by displaying the non-averaged signal value. When the signal stabilizes, a new averaging window is established and averaging resumes.

You can program the number of samples you want to average the input signal over from 1 to 255 samples. The averaging window can be set to between 1 and 65535 counts.

See the *calibration modes* diagram on Page 21 showing a breakdown of 1st, 2nd, and 3rd digits.

See *Input Signal Sampling Showing Averaging Window* diagram opposite.

Example Procedure

The example procedure on Page 24 shows how to configure channel 1 (CH1) with an averaging sample rate of 10 counts and an averaging window of 1000 counts.

Totalizer Settings

Selecting [CAL][23X] enters the Totalizer Settings Mode.

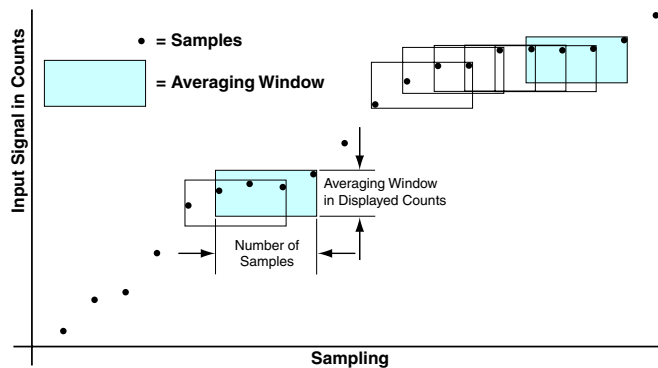

Input Signal Sampling Showing Averaging Window

This mode allows you to configure the settings for the totalizer selected in the 3rd digit. An input value of 10000 counts is applied to a selectable time period to produce the required total value.

The cutoff is a programmable limit below which the input is not totalized.

See the *calibration modes* diagram on Page 21 showing a breakdown of 1st, 2nd, and 3rd digits.

Also see the *Totalizing and Batching Supplement (NZ208)* for further details on K factor and totalizer cutoff parameters. (See page 3 for more information).

Setup 32-point Linearization Tables

Selecting [CAL][24X] enters the Setup 32-point Linearization Tables Mode.

This mode allows you to set up the linearization table or tables using the manual or auto setup modes. The table or tables can then be selected to linearize the signals on channels 1 to 4.

See *Linearization Table Notes* on Page 36 for a description of memory related issues with linearization.

See the *calibration modes* diagram on Page 21 showing a breakdown of 1st, 2nd, and 3rd digits.

Also see the *Linearizing Supplement (NZ207)* for further details on linearization table setup and use. (See page 3 for more information).

Scale Analog Output

Selecting [CAL][25X] enters the Scale Analog Output Mode.

This mode allows you to calibrate and scale the analog output signal. Before calibrating the analog output in the calibration mode, the data source for the analog output must be configured in Code 1.

See the *calibration modes* diagram on Page 21 showing a breakdown of 1st, 2nd, and 3rd digits.

Also see the *Analog Output Module Supplement (NZ200)* for further details on the analog output module. (See page 3 for more information).

Also see *Configure Data Source Procedure* on Page 27 for an example of setting the analog output data source.

Calibration Mode Procedures Supplement

The *Advanced Calibration and On Demand Mode Procedures Supplement (NZ203)* describes in detail all Tiger 320 Series meter related calibration procedures configured in the calibration mode.

Two-point Calibration

Two-point calibration is the most commonly used method of calibrating Tiger 320 Series meters when a low and high input source is available.

Example Calibration Procedure

Calibrate channel 1 (CH1) using the two-point calibration method. The calibration mode display is set to [111].

START HERE

TWO-POINT CALIBRATION

Step 1

Enter Brightness Mode

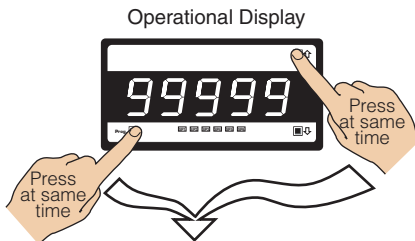

Step 2

Pass Brightness Mode and enter Calibration Mode

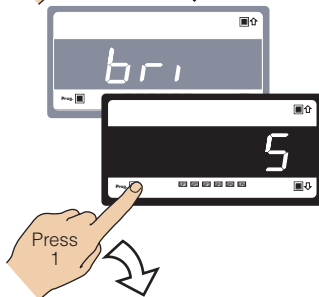

Step 3

Set Calibration Mode to [111]:
 1st Digit = 1 Selects calibration procedures
 2nd Digit = 1 Selects 2-point calibration
 3rd Digit = 1 Selects CH1 for calibration

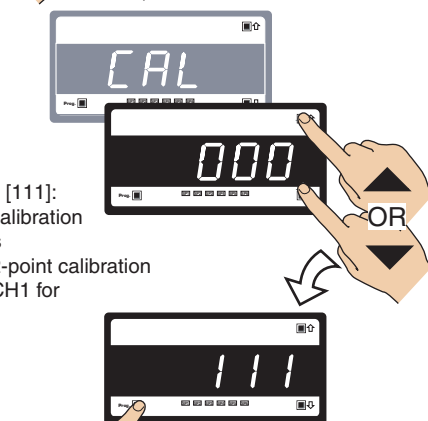

Step 4

Enter the Zero Mode



Step 5

5.1. Adjust display to desired reading for zero input
 5.2. Apply the LOW input signal

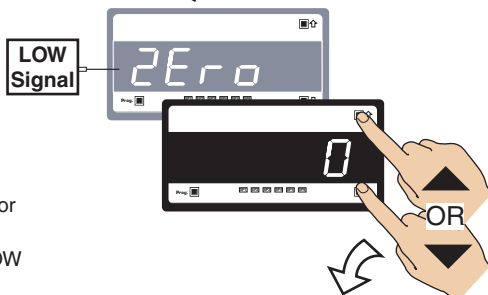

Step 6

Set reading for zero load into meter and enter Span Mode

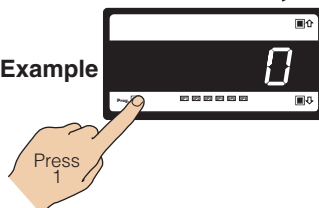

The low input source is applied to the meter when setting the zero value.



The high input source is applied to the meter when setting the span value.



Step 7

7.1. Adjust display to desired reading for span input
 7.2. Apply the HIGH input signal

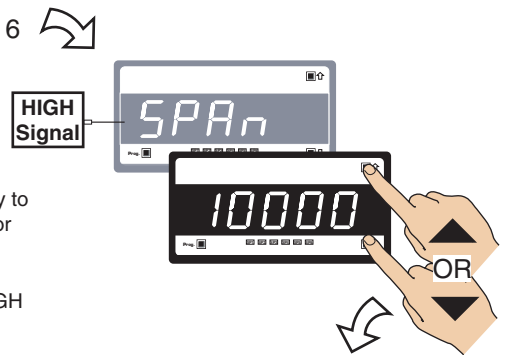

Step 8

Save zero and span settings and re-enter Calibration Mode

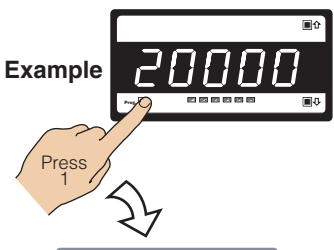

Step 9

Select the No Function Calibration Mode [000]

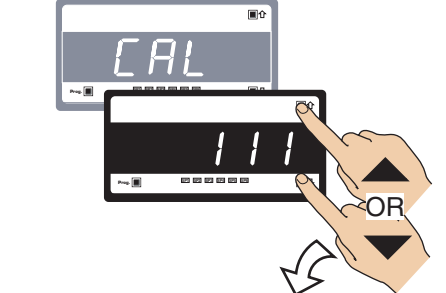

Step 10

Save Calibration Mode [000] setting and enter Code 1

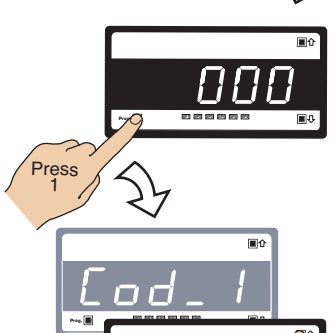

Step 11

Exit Code1. Return to Operational Display

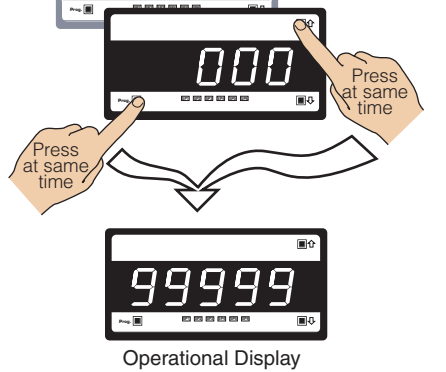

Input Signal Filtering and Averaging

Input signal filtering and averaging is configured in the calibration mode. Programmable averaging allows you to program the number of samples you want to average the input signal over (from 1 to 255 samples).

A programmable averaging window provides a quick response time to large input signal changes. The averaging window can be set to between 1 and 65535 counts.

Example Procedure:

Select an averaging sampling rate of 10 samples and an averaging window of 1000 counts for Channel 1 by setting [CAL] to [221].

See *Advanced Calibration & On Demand Mode Supplement (NZ203)* for further calibration procedures. (See page 3 for more information).

START HERE

INPUT SIGNAL FILTERING & AVERAGING

Step 1

Enter Brightness Mode

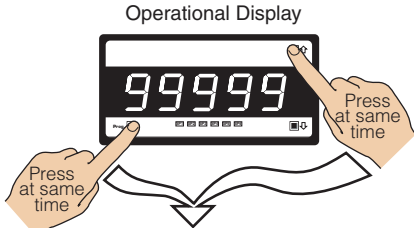

Step 2

Pass Brightness Mode and enter Calibration Mode

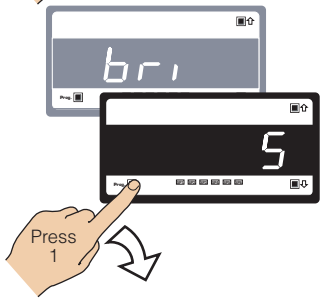

Step 3

Set Calibration Mode to [221]:
 1st Digit = 2 Selects related calibration functions
 2nd Digit = 2 Selects averaging samples for 3rd digit
 3rd Digit = 1 Selects channel 1 for 2nd digit

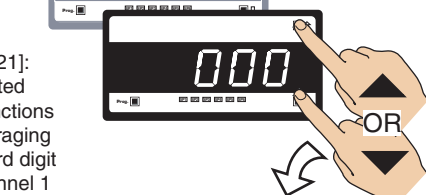

- 0 Result**
- 1 Channel 1
 - 2 Channel 2
 - 3 Channel 3
 - 4 Channel 4

Step 4

Enter the Averaging Sampling Rate Mode

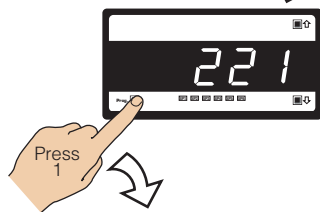

Step 5

Select averaging sampling rate from 1 to 255 samples

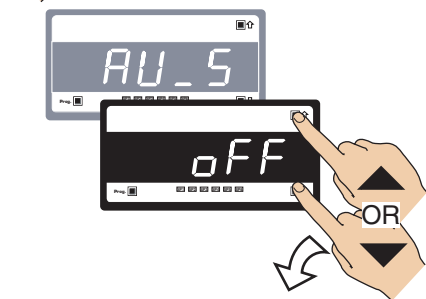

Step 6

Save averaging sampling rate setting and enter the Averaging Window mode

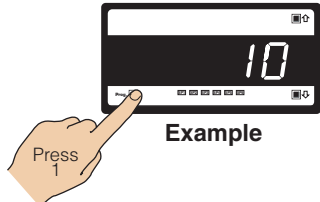

Example

To Step 7

Step 7

Select averaging window between 1 and 65535 counts

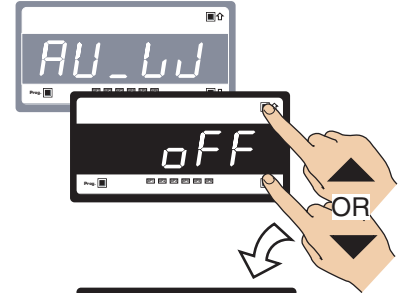

Example

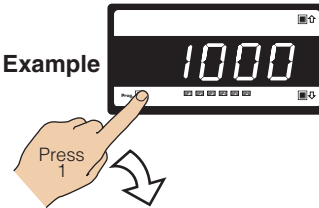

Step 8

Save averaging window settings

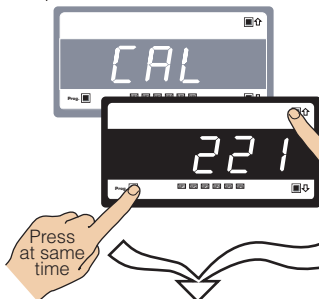

Step 9

Select [000] to leave the Calibration Mode

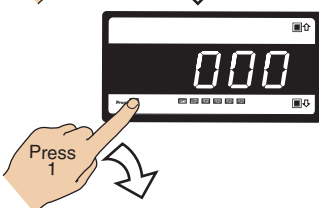

Step 10

Save settings

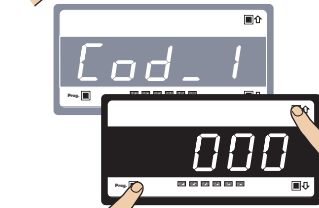

Step 11

Exit Code1. Return to Operational Display



Operational Display

CODE 1 – Display Configuration Modes

All meter display modes, except the display brightness mode, are configured in Code 1 (See diagram below). See Code 1 diagram on Page 26 for a breakdown of 1st, 2nd, and 3rd digits settings.

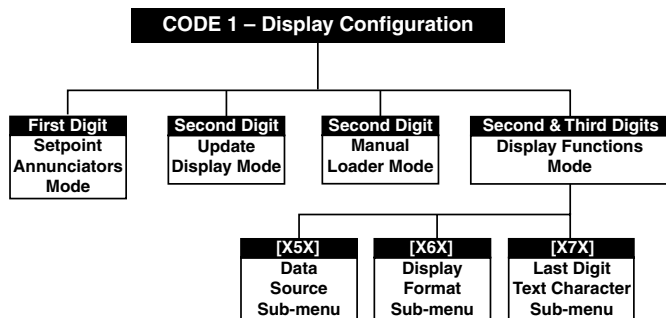

Setpoint Annunciators Mode

The setpoint annunciators mode is configured by changing the 1st digit in Code 1. The setpoint annunciators can be configured to operate as follows:

- On when the setpoint activates.
- All annunciators are permanently on and each one only goes off when its setpoint activates.
- All annunciators are always off (See Note 1 on Code 1 diagram on Page 26).
- Setpoint **1** annunciator comes **on** indicating a **rising signal**. Setpoint **2** annunciator comes **on** indicating a **falling signal**.

The example procedure on Page 30 shows how to select the setpoint annunciators to come ON when the setpoints are OFF (not active).

Update Display at Selected Sample Rate

The meter's default display update rate is 0.5 seconds and is set in the 2nd digit of Code 1 as [X0X].

The display can be configured to update at the analog sample rate selected in Code 2. The example procedure on Page 30 shows how to configure the display to update at typically 10 samples per second by setting Code 1 to [X2X].

For these settings to take effect, the analog sample rate must be set at [2XX] in Code 2.

See Code 2 – Channel 1 Measurement Task and Sampling Rate on Page 31 for an example.

Manual Loader Mode

The meter can be configured to function exclusively as a manual loader by setting Code 1 to [X1X].

See Analog Output Module Supplement (NZ200) for full details on manual loader mode functions. (See page 3 for more information).

Display Functions Mode

The display functions mode is configured by changing the 2nd and 3rd digits in Code 1:

- Selecting [X5X] enters the **Data Source** sub-menu.
- Selecting [X6X] enters the **Display Format** sub-menu.
- Selecting [X7X] enters the **Last Digit Text Character** sub-menu.

Data Source – 2nd Digit [X5X]

The data source for the primary display is configured by selecting **5** in the 2nd digit and the **0** in the 3rd digit:

Note:

[XX1] Second Display is the bargraph display on models DI-50B51, FI-B101D50, and GI-50B101. The [XX1] Second Display and [XX2] Third Display only apply to DI-503 meters with three displays.

The 2nd digit in Code 1 can also be used to configure the data source for the remaining functions in the 3rd digit:

- [X53] = Peak and Valley.
- [X54] = Analog Output 1.
- [X55] = Analog Output 2.
- [X56] = Totalizer 1.
- [X57] = Totalizer 2.

Selecting **5** in the 2nd digit enters a sub-menu and allows you to select the data from one of a number of meter registers as the data source for the displays or functions selected in the 3rd digit.

The example procedure on Page 27 shows how to select the data source for the **primary** display. The three digits are set to [X50].

Display Format – 2nd Digit [X6X]

Selecting **6** in the 2nd digit enters the Display Format sub-menu where the following display format settings can all be configured:

- Last digit rounding.
- Display units (decimal, octal, or optional 12 or 24-hour clock).
- Decimal point placement.

The example procedure on Page 28 shows how to configure the three display format modes for the 3rd digit selection.

Text Character – 2nd Digit [X7X]

Selecting **7** in the 2nd digit allows you to select one of 54 characters and apply it to the last digit when the meter is in the operational display.

For example, if the meter was measuring a temperature, the display could be configured to display the reading with a C or an F in the last digit for °C or °F.

The example procedure on Page 29 shows how to configure the last digit text character as "C" for centigrade (°C) for the 3rd digit selection.

Note:

After setting any or all the above three modes [X5X], [X6X], [X7X], the Code 1 display must be set back to [X0X] to leave Code 1 and carry on programming.

[Code 1] - Display Configuration continued

FIRST DIGIT	SECOND DIGIT	THIRD DIGIT
CODE 1 – DISPLAY CONFIGURATION		
FRONT PANEL ANNUNCIATORS	DISPLAY FUNCTIONS	SELECT DATA SOURCE FOR
0 ON when Setpoints are ON (relay energized) 1 ON when Setpoints are OFF (relay de-energized) 2 Always OFF. See Note 1 3 LED SP1 ON indicates RISING signal trend. LED SP2 ON indicates FALLING signal trend.	0 Normal Display Mode (i.e. operational display shows selected register) updates every 0.5 seconds 1 Manual Loader Mode (Direct Display). See Note* 2 Update at controlled output rate selected in Code 2 3 - 4 - 5 Select data source as per 3rd digit. See Note 4 6 Select display format as per 3rd digit. See Note 4 7 Select text character as per 3rd digit. See Note 4	0 Primary Display 1 Second Display. See Note 2 2 Third Display. See Note 2 3 Peak/Valley 4 Analog Output 1 5 Analog Output 2 6 Totalizer 1 7 Totalizer 2
		SELECT DISPLAY FORMAT FOR
		0 Result 1 Channel 1 2 Channel 2 3 Channel 3 4 Channel 4 5 Default Display 6 Total 1 7 Total 2
		SELECT TEXT CHARACTER FOR
		0 Result 1 Channel 1 2 Channel 2 3 Channel 3 4 Channel 4 5 Default Display 6 Total 1 7 Total 2

Select Data Source
See diagram below

Select Display Format
See diagram below

Select Last Digit Text Character
See diagram below

Note*: For the Manual Loader Mode (Direct Display) to work, with Code 1 set to [X54] the data source for the analog output (1 or 2) must be set to [diSP].

Operating range upper and lower limits can be set for the manual loader mode.

The setpoint activation values for setpoint 5 becomes the upper limit and setpoint 6 becomes the lower limit.

When either the direct display or on demand manual loader mode is programmed into the meter, the values for setpoint 5 and setpoint 6 are activated as upper and lower limits.

See Analog Output Supplement for further details.

Note 1:

LED annunciators are always off, except when the meter is in single channel VOLTAGE or CURRENT mode and Code 3 = [X6X], or Code 7 = [X6X] in which case the LEDs indicate which 32-point table has been selected from the rear pins (SP1 = Table 1, SP2 = Table 2, SP3 = Table 3, SP4 = Table 4).

Note 2:

These options are only for use with meters that have more than one display. With bargraph meters the PRIMARY display is the digital display, and the SECONDARY display is the bargraph display.

Select Data Source

P SourC OFF

[100] [10] [1] [diSP] [rESL1] [Ch1]
 [200] [Ch2]
 [244] [Ch3]
 [tArE] [VALE] [PEAK] [tot_2] [tot_1] [Ch4]

Use the [↑] [↓] buttons to cycle through the Registers Menu and Registers (1 to 244) to select data source for displays, peak and valley, totalizers and analog output (also see page 44).

Display Format Mode

P d.iSP 000 Program the three digits to the required display function mode

FIRST DIGIT	SECOND DIGIT	THIRD DIGIT
LAST DIGIT ROUNDING	DISPLAY UNITS	DECIMAL POINT PLACEMENT
0 No rounding 1 Rounding by 2's 2 Rounding by 5's 3 Rounding by 10's	0 Decimal 1 24-hour clock mode Hours: Minutes: Seconds (6-digit version only) 2 12-hour clock mode (12:30 am is displayed as 12:30A. 12:30 pm is displayed as 12:30P) 3 24-hour clock mode Days: Hours:Minutes (6-digit version only) 4 - 5 - 6 - 7 Octal	0 No decimal point 1 - 2 - 3 X.XXXX 4 X.XXX 5 X.XX 6 X.X 7 Decimal Point set from the rear (X.XXXX to XXXXX) See Note 3. Also See Note 4.

Note:
Selecting 1, 2, or 3 in the 2nd digit of this mode configures the display of the selected channel as a clock.

Note 3:
These functions are only available on selected input modules.

Note 4:
If Code 1's display modes have been entered (second digit set to 5, 6, or 7), the display will cycle between Code 1 and the display functions mode each time the PROGRAM button is pressed. To leave the cycle, the Code 1 digits must be reset to any relevant function between [X00] to [X20]. This takes you into Code 2.

Select Last Digit Text Character

tE3.t OFF

Use the [↑] button to cycle through the menu, and the [↓] button to cycle back.

Press the Up or Down button 4 times as the next 4 characters are blank.

Configure Data Source Procedure

The following example procedure describes how to select the source of the data to be displayed for the third digit selection.

Example Procedure:

Configure the Primary Display with the display [diSP] as the data source by setting Code 1 to [X50]. See diagram at the bottom of the page for data source selection options.



Programming Tip

To enter the Main Programming Mode press the [P] and [↑] buttons at the same time. To exit and return to the operational display, press the [P] and [↓] buttons again at the same time.

At the end of any procedure (Step 8 in this procedure) the [P] must be pressed before the [↓] and [↑] buttons are pressed, otherwise the meter returns to the operational display without saving the new settings.

Select Data Source

[P] SourC [off]

- [100] [↑][↓] [10] [↑][↓] [1] ← [↑][↓] → [diSP] [↑][↓] [rESLr] [↑][↓] [Ch1] [↑][↓]
 - [200] [↑][↓] [Ch2] [↑][↓]
 - [244] [↑][↓] [Ch3] [↑][↓]
 - [tArE] [↑][↓] [VALEy] [↑][↓] [PEAK] [↑][↓] [tot_2] [↑][↓] [tot_1] [↑][↓] [Ch4] [↑][↓]
- Use the [↑] [↓] buttons to cycle through the Registers Menu and Registers (1 to 244) to select data source for displays (also see page 44).

START HERE

CONFIGURE DATA SOURCE

Step 1

Enter Brightness Mode

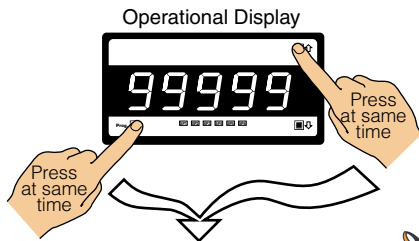

Step 2

Pass Brightness and Calibration Modes and enter Code 1

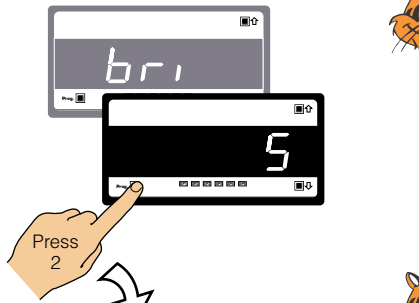

Step 3

Set Code 1 to [X50]:
 1st Digit = X Note relevant
 2nd Digit = 5 Selects data source mode
 3rd Digit = 0 Selects Primary Display

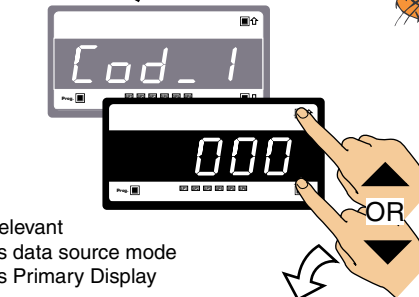

Step 4

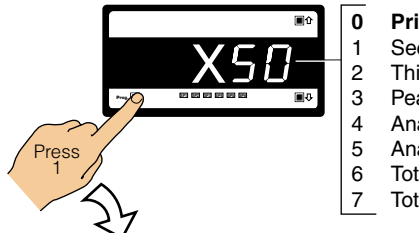

- 0 Primary Display
- 1 Second Display (See Note)
- 2 Third Display (See Note)
- 3 Peak/Valley
- 4 Analog Output 1
- 5 Analog Output 2
- 6 Totalizer 1
- 7 Totalizer 2

Step 5

Select [diSP] as the Data Source from the options listed in the Select Data Source diagram below.

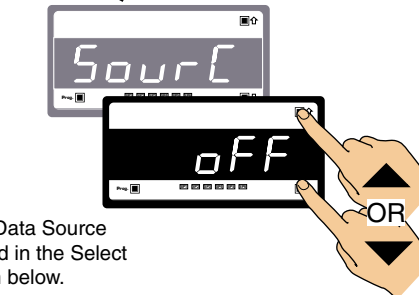

Step 6

Programming Tip

Pressing the [↓] button reaches [000] faster.

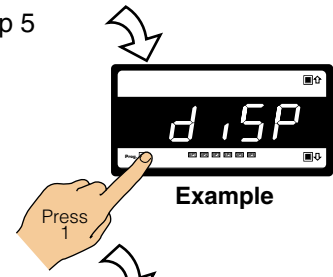

Step 7

Select [000] to leave Code 1

Programming Tip

Pressing the [↑] and [↓] buttons at the same time increases the displayed parameter in increments of 100 counts.

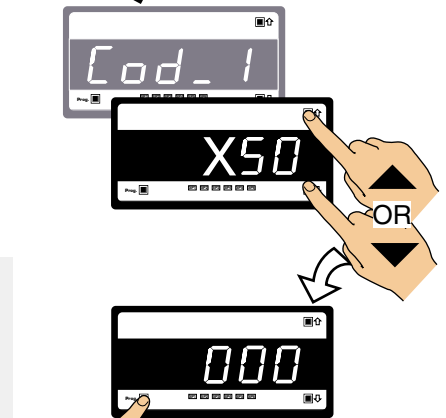

Step 8

Save Data Source setting

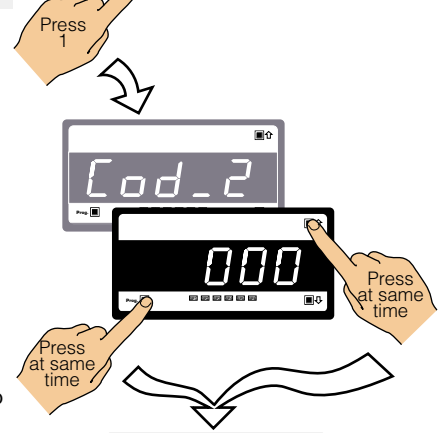

Step 9

Exit Code 2. Return to Operational Display



Note:
 Options 1 and 2 listed for the 3rd digit in Step 3 above are only for use with meters that have more than one display. With bargraph meters the PRIMARY display is the digital display, and the SECONDARY display is the bargraph display.

Configure Display Format Mode Procedure

The following example procedure describes how to configure the display format mode for the 3rd digit selection and covers:

- Last Digit Rounding.
- Display Units.
- Decimal Point Placement.

Example Procedure:

Configure the display format mode for channel 1 with rounding by 2's, decimal display units, and the decimal point placed between display digits 4 and 5 by setting Code 1 to [X61].

Display Format Mode

P **d.5P** **000** Program the three digits to the required display format mode

FIRST DIGIT LAST DIGIT ROUNDING
0 No rounding
1 Rounding by 2's
2 Rounding by 5's
3 Rounding by 10's

SECOND DIGIT DISPLAY UNITS
0 Decimal
1 24-hour clock mode Hours: Minutes: Seconds (6-digit version only)
2 12-hour clock mode (12:30 am is displayed as 12:30A. 12:30 pm is displayed as 12:30P)
3 24-hour clock mode Days: Hours:Minutes (6-digit version only)
4 -
5 -
6 -
7 Octal

THIRD DIGIT DECIMAL POINT PLACEMENT
0 No decimal point
1 -
2 -
3 X.XXXXX
4 X.XXX
5 X.XX
6 X.X
7 Decimal Point set from the rear (X.XXXXX to XXXXX) See Note 3. Also See Note 4.

Note:
Selecting 1, 2, or 3 in the 2nd digit of the Display Format Mode configures the display of the selected channel (see Step 4) as a clock.

START HERE

CONFIGURE DISPLAY FORMAT

Step 1

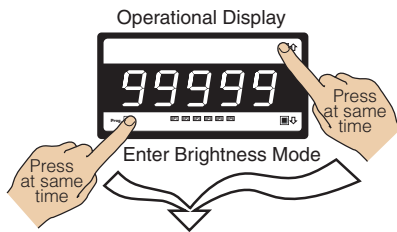

Step 2

Pass Brightness and Calibration Modes and enter Code 1

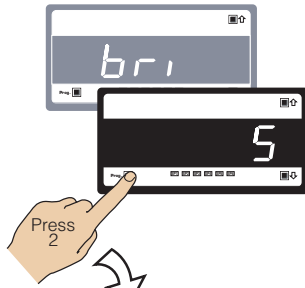

Step 3

Set Code 1 to [X61]:
1st Digit = X Not relevant
2nd Digit = 6 Selects display functions
3rd Digit = 1 Selects Channel 1

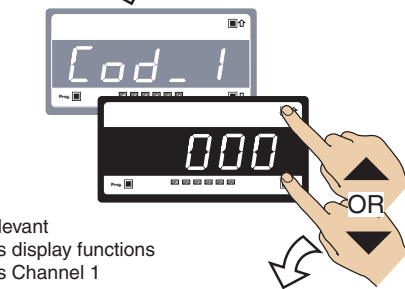

Step 4

Enter the Display format Mode

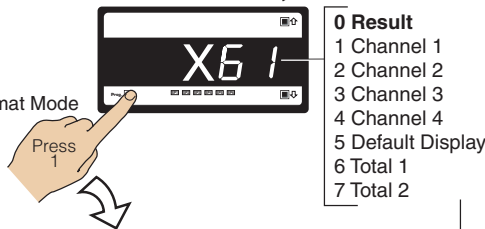

Step 5

Set the Display Format Mode to [106]:

1st Digit = 1 Rounding by 2's
2nd Digit = 0 Decimal display
3rd Digit = 6 Decimal point

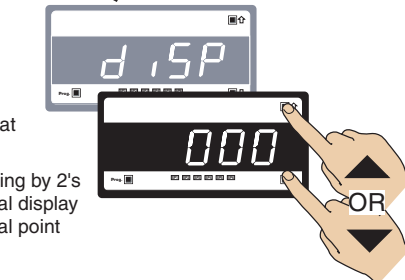

From Step 5

Step 6

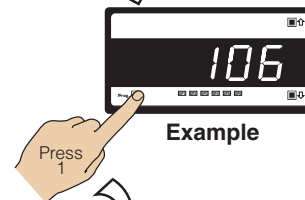

Step 7

Select [000] to leave Code 1

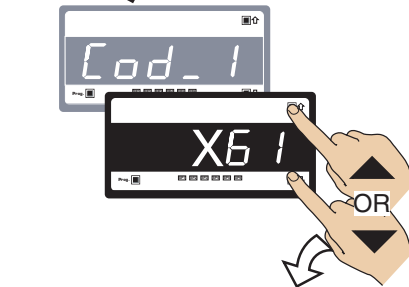

Step 8

Save Display Functions setting

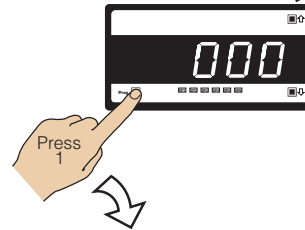

Step 9

Exit Code 2. Return to Operational Display

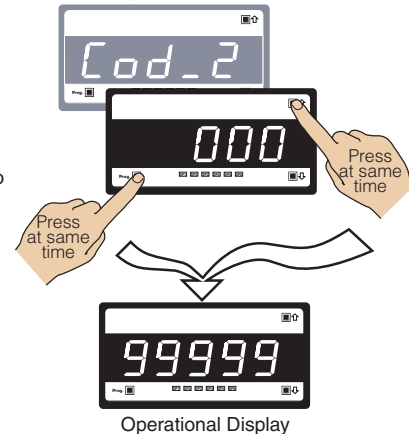

Configure Setpoint Annunciators Procedure

The following example procedure describes how to configure setpoint annunciators.

Example Procedure:

Configure the setpoint annunciators to come ON when the setpoints are OFF (not active) by setting Code 1 to [1XX].

Configure Update at Sample Rate Procedure

The following example procedure describes how to configure the display to update at the sample rate selected in Code 2.

Example Procedure:

Update the display at the sample rate selected in Code 2 by setting Code 1 to [X2X].

START HERE

CONFIGURE SETPOINT ANNUNCIATORS

Step 1

Enter Brightness Mode

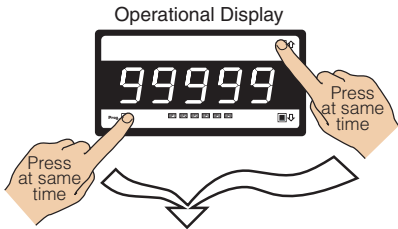

Step 2

Pass Brightness and Calibration Modes and enter Code 1

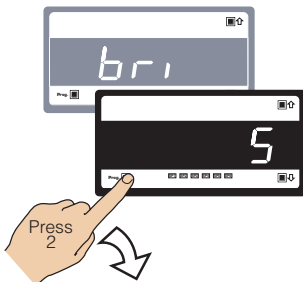

Step 3

Select SP Annunciators setting [1XX]:

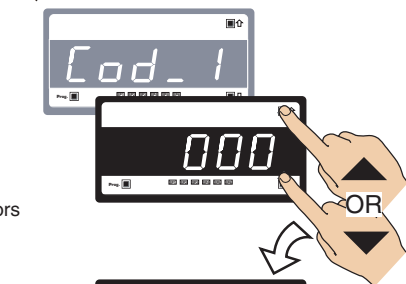

Step 4

Save the settings and enter Code 2

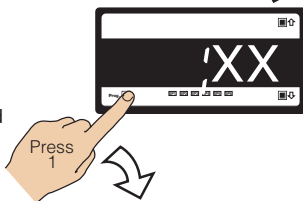

Step 5

Exit Code 2. Return to Operational Display

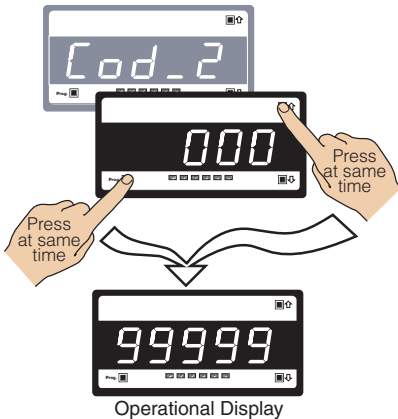

START HERE

CONFIGURE UPDATE AT SAMPLE RATE

Step 1

Enter Brightness Mode

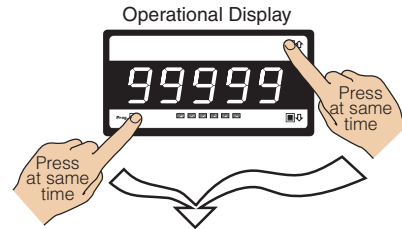

Step 2

Pass Brightness and Calibration Modes and enter Code 1

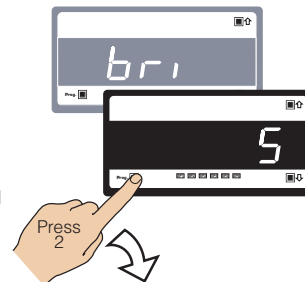

Step 3

Select update at sample rate setting [X2X]:

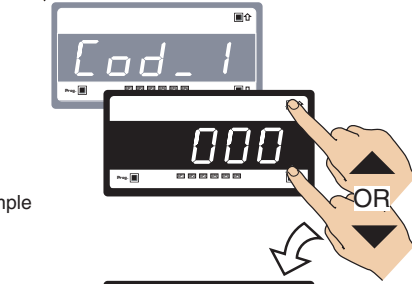

Step 4

Save setting and enter Code 2

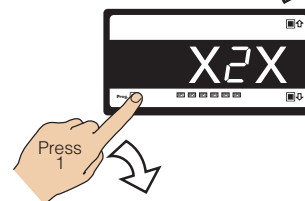

Step 5

Exit Code 2. Return to Operational Display

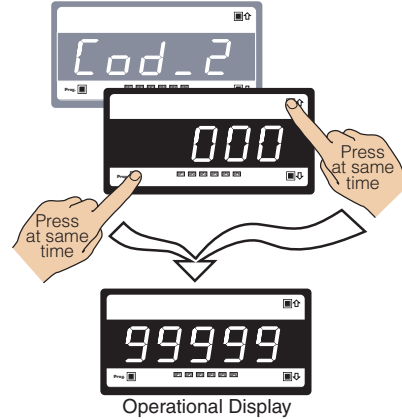

Programming Tip

The *Configuring Setpoint Annunciators* and the *Update at Sample Rate* procedures can be combined so that Code 1 could be set to [12X] (for the above examples) in a single procedure.

[Code 2] - Channel 1 Measurement Task & Sampling Rate

The Tiger 320 Series meter can be configured to measure almost any input signal. The measurement task and sampling rate for Channel 1 (CH1) is configured in the three digits of Code 2. The diagram below lists the available configuration selections in Code 2.

Example Procedure:

Configure CH1 for a voltage input with 10 samples/second (60 Hz) sampling rate and output rate of 0.1 seconds by setting Code 2 to [000].

FIRST DIGIT	SECOND DIGIT	THIRD DIGIT
CODE 2 – CHANNEL 1 MEASUREMENT TASK AND SAMPLING RATE		
ANALOG SAMPLE RATE 0 Sample Rate: Typically 10 samples/second (60 Hz) Output Rate: 0.1 seconds See Example <hr/> 1 Sample Rate: Typically 10 samples/second (50 Hz) Output Rate: 0.1 seconds See Example <hr/> 2 Sample Rate: Typically 10 samples/second (60 Hz) Output Rate: 10 milliseconds See Example <hr/> 3 Sample Rate: Typically 10 samples/second (50 Hz) Output Rate: 10 milliseconds See Example <hr/> <i>Note:</i> Output Rate refers to setpoint and macro outputs, and input rates from smart input modules. <hr/> <i>Note:</i> All above sample rates are quoted for single channel operation. Where more than one channel is available, sample rates are divided by the number of active channels. See Example.	MEASUREMENT TASK 0 Voltage, Current <hr/> 1 TC (3rd digit selects type of TC) <hr/> 2 RTD 3-wire (3rd digit selects type of RTD) <hr/> 3 RTD 2- or 4-wire (3rd digit selects type of RTD) <hr/> 4 Frequency <hr/> 5 Period <hr/> 6 Counter <hr/> 7 Smart Input Module <hr/> Example: 10 Samples/Second 1 Channel = 10 samples/second 2 Channels = 5 samples/second 3 Channels = 3.33 samples/second 4 Channels = 2.5 samples/second	FOR VOLTAGE 0 No function 1 Peak detector 2 Pressure with Auto-cal <hr/> FOR THERMOCOUPLE 0 Type J 1 Type K 2 Type R 3 Type S 4 Type T 5 Type B 6 Type N 7 Select user defined table set up in CAL [24X] <hr/> FOR RTD TYPE (2-, 3-, 4- WIRE) 0 Resistance 1 RTD 385 2 RTD 392 3 RTD 120 4 Cn 10 <hr/> FREQUENCY RANGE 0 99.999 Hz range from 0.010 Hz 1 99.999 Hz range from 2.000 Hz 2 999.99 Hz range from 0.01 Hz 3 999.99 Hz range from 2.00 Hz 4 9999.9 Hz range from 0.1 Hz 5 9999.9 kHz range from 2.0 Hz 6 99 kHz range from 1 Hz (1 s gate) 7 655.35 kHz range from 10 Hz (0.1 s gate) <hr/> PERIOD MEASUREMENT 0 99.999 s 1 9.9999 s 2 999.99 ms 3 99.999 ms <hr/> COUNTER/RESIDENT TIMER/CLOCK 0 Counter input with 16-bit Pre-scaler 1 Setting of 16-bit Pre-scaler 2 Debounced Counter with Pre-scaler 3 Up/Down Counter with Pre-scaler 4 0.1 sec Timer with Pre-scaler 5 - 6 External 24-hour clock 7 Internal 24-hour clock <hr/> SMART INPUT MODULE 0 Output Register 1 1 Output Register 2 2 Output Register 3 3 Output Register 4 4 Output Register 5 5 Output Register 6 6 Output Register 7 7 Smart Input Module Setup.

START HERE

CONFIGURE CH1 MEASUREMENT TASK & SAMPLING RATE

Step 1

Enter Brightness Mode

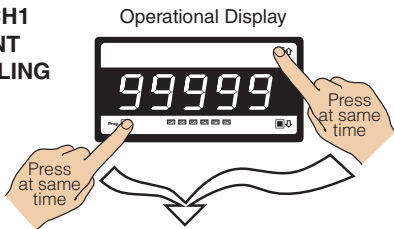

Step 2

Pass Brightness Mode, Calibration Mode, Code 1, and enter Code 2

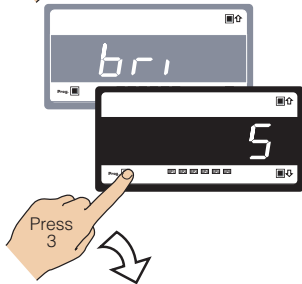

X61 Sets Prescaler	
1 =	0.1 second
10 =	1 second
600 =	1 minute
36000 =	1 Hour***

***Note: For the 1 hour setting, the scale factor for CH1 must be set to 0.1 in the calibration mode setting [111].

Use buttons to set prescale values

Step 3

Set Code 2 to [000]:
 1st Digit = 0 Selects 10 samples/sec (60 Hz)
 2nd Digit = 0 Selects voltage, current
 3rd Digit = 0 Selects no function

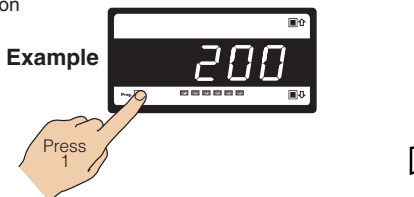

Step 4

Save setting and enter Code 3

Step 5

Exit Code 3. Return to Operational Display

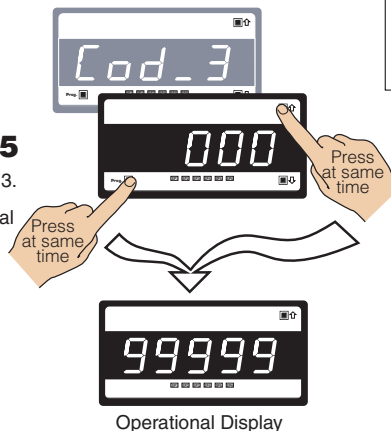

Press 5776 1 000

Use the buttons to set the required smart input module code (0 to 377). See *I-Series Input Module Guide (Z87)* for code details.

[Code 3] - Channel 1 Post Processing & Serial Mode Functions

Post processing functions refer to functions that occur to the input after it has been configured and scaled.

Post processing for Channel 1 (CH1) is configured in the first digit of Code 3. The diagram below lists the available post processing configuration selections in Code 3 (1st digit only).

FIRST DIGIT
CH1 POST PROCESSING
0 Direct Display of Input (no processing)
1 Square Root of Channel 1
2 Inverse of Channel 1
3 -

SECOND DIGIT
CODE 3 – CHANNEL 1 FUNCTIONS (POST PROCESSING & SERIAL MODE)
32-POINT LINEARIZATION FOR CHANNEL 1
0 No Linearization on CH1
1 32-point Linearization on CH1 using Table 1
2 32-point Linearization on CH1 using Table 2. <i>See Note 5</i>
3 32-point Linearization on CH1 using Table 3. <i>See Note 5</i>
4 32-point Linearization on CH1 using Table 4. <i>See Note 5</i>
5 125-point Linearization on CH1 (Tables 1 to 4 cascaded). <i>See Note 5</i>
6 32-point Linearization on CH1 (Tables 1 to 4 selected from the rear pins of selected input modules). The selected table is not available if CH2, CH3, or CH4 is operating in the analog output mode. CH1 must be set to Voltage, Current in Code 2 [X0X]. <i>See Note 5</i>
7 -

Note:
All linearization tables are set up in the Calibration Mode [24X].

THIRD DIGIT
SERIAL MODE
0 ASCII Mode
1 Modbus Mode
2 Master mode (used to customize print mode protocols via macro)
3 Print Mode
4 Ethernet Mode. <i>See Note 6</i>
5 DeviceNet Mode (requires DeviceNet hardware module). <i>See Note 6</i>

Note 5:
If only 4 kB memory installed, functions 2 to 6 are not available in:

- Code 3 second digit.
- Code 4 third digit.
- Code 7 second digit.

Note 6:
These functions are not available on all models and in some cases require additional hardware.

START HERE

CONFIGURE CH1 POST PROCESSING FUNCTIONS

Step 1

Enter Brightness Mode

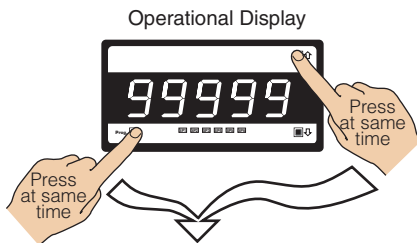

Step 2

Pass Brightness Mode, Calibration Mode, Codes 1 and 2, and enter Code 3

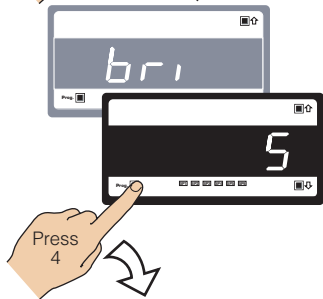

Step 3

Set Code 3 to [100]:
1st Digit = 1 Square root of CH1
2nd Digit = 0 No linearization
3rd Digit = 0 ASCII Mode

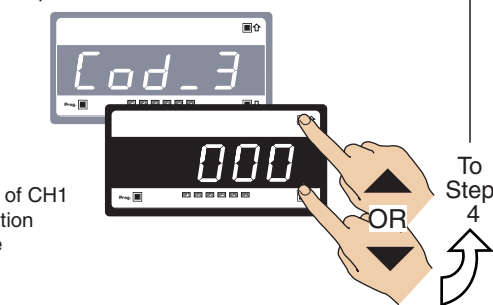

Example Procedure:

Configure the meter to apply square root to the CH1 signal by setting Code 3 to [100].

From Step 3

Step 4

Save Post Processing setting

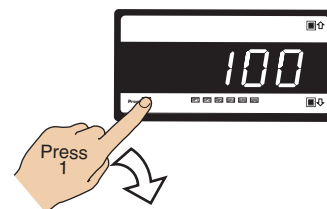

Step 5

Exit Code 4. Return to Operational Display

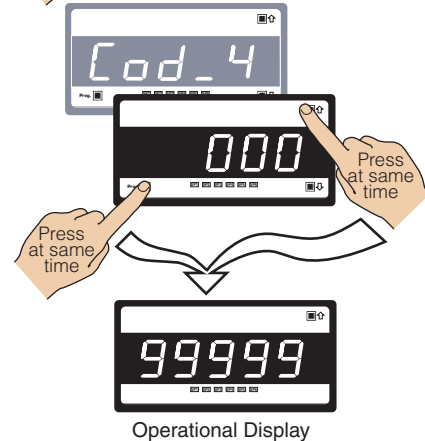

Print Mode – Data Printing Direct to Serial Printer

Print mode data logging is a simple method of capturing data using the meter's print mode. The data can be printed directly to a serial printer from the meter.

The print mode uses the meter's serial communications port to connect to a remote serial printer. The data can be printed with or without a Day: Month: Year or Hours: Minutes: Seconds time stamp.

Time stamp settings are configured in Code 8.



Programming tip

For full details on the Serial Mode, see *Serial Communications Output Module* supplement.

Print Mode – Data Printing Direct to PC

The print mode can also be used to print data to a PC where it is logged in a Windows Terminal program.

The print mode uses the meter's serial communications port to connect to the PC. The data can be logged with or without a Day: Month: Year or Hours: Minutes: Seconds time stamp.

Time stamp settings are configured in Code 8.

[Code 4] - Channel 2 Measurement Task & Sampling Rate

Code 4 is a single code that combines all the configuration and post processing functions available for Channel 2.

When a **dual input** signal conditioner is installed, the second input signal is processed and displayed on CH2.

Measurement task and 32-point linearization for CH2 is configured in the 1st and 2nd digits of Code 4. The diagram opposite lists the available configuration selections in Code 4.

Example Procedure:

Configure CH2 for a direct voltage input with no linearization by setting Code 4 to **[010]**.

See *I-Series Input Modules Guide (Z87)* for procedures to set up a dual input module.

FIRST DIGIT	SECOND DIGIT	THIRD DIGIT
CODE 4 – CHANNEL 2 MEASUREMENT TASK AND 32-POINT LINEARIZATION		
MEASUREMENT TASK	FOR VOLTAGE & CURRENT	32-POINT LINEARIZATION FOR CH2
0 Voltage, Current	0 Channel 2 Disabled	0 No user defined Linearization on CH2
1 TC (type as per 2nd digit)	1 Direct (no post processing)	1 32-point Linearization on CH2 using Table 1
2 RTD (type as per 2nd digit)	2 Square Root of Channel 2	2 32-point Linearization on CH2 using Table 2. See Note 5
3 Second Digital Input Channel (type as per 2nd digit)	3 Inverse of Channel 2	3 32-point Linearization on CH2 using Table 3. See Note 5
	4 Output Register 1 (smart module)	4 32-point Linearization on CH2 using Table 4. See Note 5
	5 Output Register 2 (smart module)	5 125-point Linearization on CH2 (Tables 1 to 4 cascaded). See Note 5
	6 Output Register 3 (smart module)	6 -
	7 Output Register 4 (smart module)	7 -
	FOR THERMOCOUPLE	
	0 Type J	
	1 Type K	
	2 Type R	
	3 Type S	
	4 Type T	
	5 Type B	
	6 Type N	
	7 Select user defined table set up in CAL [24X]	
	FOR RTD TYPE (3-WIRE)	
	0 Resistance	
	1 RTD 385	
	2 RTD 392	
	3 RTD 120	
	4 Cn10	
	DIGITAL INPUT	
	0 Frequency - 99.999 Hz range from 0.01 Hz	
	1 Frequency - 999.99 Hz range from 0.01 Hz	
	2 Frequency - 99.999 kHz range from 1 Hz (1 s gate)	
	3 Frequency - 500 kHz range from 10 Hz (0.1 s gate)	
	4 Period - 9.9999 s (100 μs resolution)	
	5 Period - 999.99 ms (10 μs resolution)	
	6 Up/Down Counter with Prescaler	
	7 Set Prescaler	

Note 5:
If only 4 kB memory installed, functions 2 to 6 are not available in:

- Code 3 second digit.
- Code 4 third digit.
- Code 7 second digit.

PRE_S [] []

Use buttons to set prescale values from 1 to 65535 counts

START HERE

CONFIGURE CH2 MEASUREMENT TASK

Step 1

Enter Brightness Mode

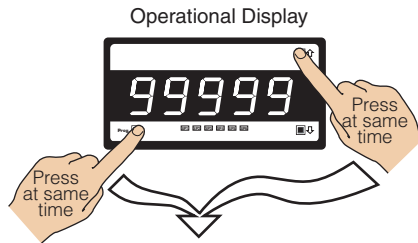

Step 2

Pass Brightness Mode, Calibration Mode, and Codes 1 to 3, and enter Code 4

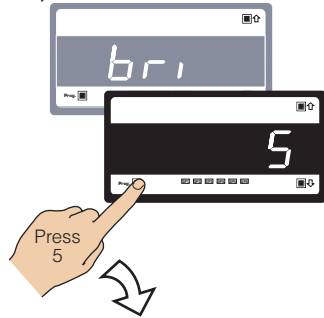

Step 3

Set Code 4 to [010]:
1st Digit = 0 Selects voltage, current
2nd Digit = 3 Selects inverse of CH2
3rd Digit = 0 Selects no linearization

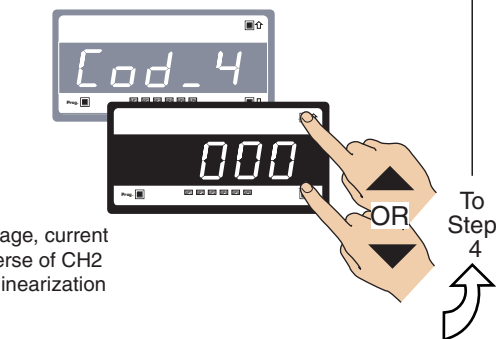

Step 4

Save CH 2 Measurement Task setting

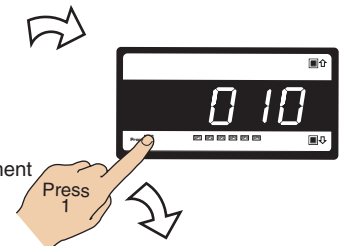

Step 5

Exit Code 5. Return to Operational Display

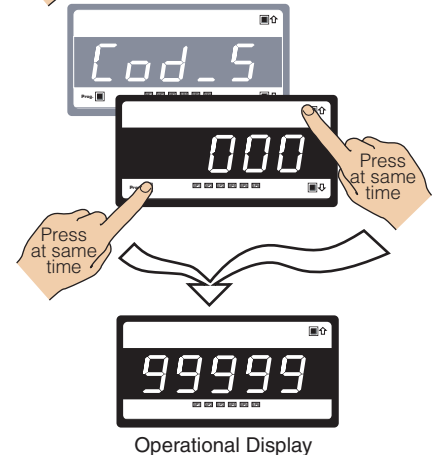

[Code 5] - Channel 3 Functions

Code 5 is a single code that combines all the configuration and post processing functions available for Channel 3.

When a **triple input** signal conditioner is installed, the third input signal is processed and displayed on CH3.

Post processing and measurement task functions for CH3 are configured in the 1st, 2nd, and 3rd digits of Code 5. The diagram opposite lists the available configuration selections in Code 5.

FIRST DIGIT	SECOND DIGIT	THIRD DIGIT
CODE 5 - CHANNEL 3 FUNCTIONS		
CH3 POST PROCESSING	MEASUREMENT TASK	FOR THERMOCOUPLE
0 Direct Display of Input (no processing)	0 No Function	0 Type J
1 Square Root of Channel 3	1 Voltage / current	1 Type K
2 Inverse of Channel 3	2 TC (3rd digit selects type of TC)	2 Type R
3 4 kB Meters	3 RTD (3rd digit selects type of RTD)	3 Type S
32-point Linearization of CH3 using Table 1	4 Real Time Clock & Timer (3rd digit selects type)	4 Type T
32 kB Meters	5 -	5 Type B
32-point Linearization of CH3 using Table 3	6 -	6 Type N
<i>Note:</i> All linearization tables are set up in the Calibration Mode [24X].	7 Smart Input Module (3rd digit selects register)	7 Select user defined linearization table (Table 1) set up in CAL [24X]
		FOR RTD TYPE (2-, 3-, 4- WIRE)
		0 Resistance
		1 RTD 385
		2 RTD 392
		3 RTD 120
		4 Cn 10
		FOR REAL-TIME CLOCK & TIMER
		0 HRS:MIN:SEC
		1 HRS:MIN
		2 -
		3 -
		4 1 Second Count UP Timer
		5 1 Second Count DOWN Timer
		6 -
		7 -
		FOR SMART INPUT MODULE
		0 Output Register 1
		1 Output Register 2
		2 Output Register 3
		3 Output Register 4
		4 Output Register 5
		5 Output Register 6
		6 Output Register 7
		7 Smart Input Module Register 2 Code Setup

Example Procedure:

Configure CH3 to display the square root of a voltage input by setting Code 5 to [11X].

See *I-Series Input Modules Guide (Z87)* for procedures to set up a triple input module.

START HERE

CONFIGURE CH3 FUNCTIONS

Step 1

Enter Brightness Mode

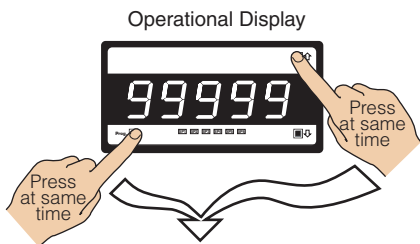

Step 2

Pass Brightness Mode, Calibration Mode, and Codes 1 to 4 and enter Code 5

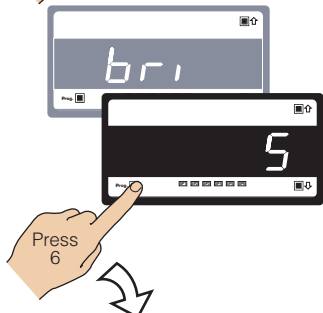

Step 3

Set Code 5 to [11X]:
 1st Digit = 1 Selects square root of CH3
 2nd Digit = 1 Selects voltage, current
 3rd Digit = X Not relevant

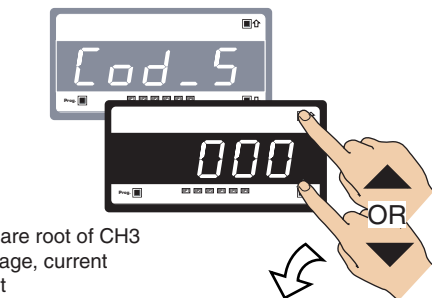

Step 4

Save CH3 setting

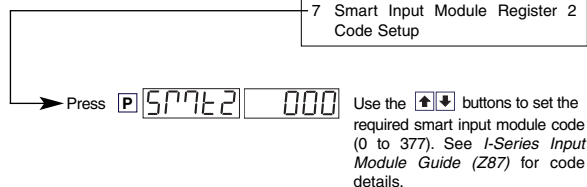
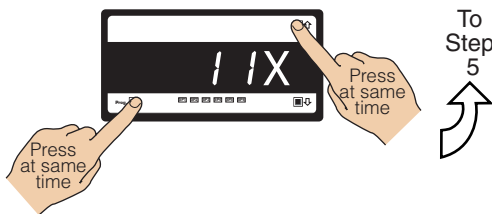

From Step 4

Step 5

Exit Code 6. Return to Operational Display

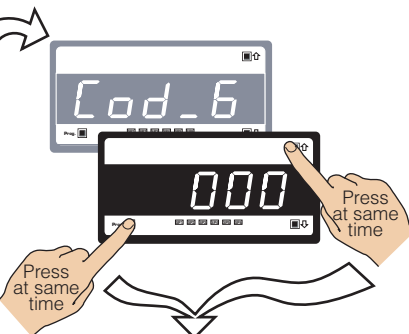

Operational Display

[CodE_6] - Channel 4 Functions

Code 6 is a single code that combines all the configuration and post processing functions available for Channel 4.

When a **quad input** signal conditioner is installed, the fourth input signal is processed and displayed on CH4.

Post processing and measurement task functions for CH4 are configured in the 1st, 2nd, and 3rd digits of Code 6. The diagram opposite lists the available configuration selections in Code 6.

Example Procedure:

Configure CH4 for a direct display of voltage input by setting Code 6 to [01X].

FIRST DIGIT	SECOND DIGIT	THIRD DIGIT
CODE 6 - CHANNEL 4 FUNCTIONS		
CH4 POST PROCESSING	MEASUREMENT TASK	FOR THERMOCOUPLE
0 Direct Display of Input (no processing) 1 Square Root of Channel 4 2 Inverse of Channel 4 3 4 kB Meters 32-point Linearization of CH4 using Table 1 32 kB Meters 32-point Linearization of CH4 using Table 4 <i>Note:</i> All linearization tables are set up in the Calibration Mode [24X].	0 No Function 1 Voltage / Current 2 TC (3rd digit selects type of TC). See Note 7 3 RTD (3rd digit selects type of RTD). See Note 7 4 Real Time Clock and Timer (3rd digit selects type) 5 - 6 - 7 Smart Input Module (3rd digit selects register)	0 Type J 1 Type K 2 Type R 3 Type S 4 Type T 5 Type B 6 Type N 7 Select user defined linearization table (Table 1) set up in CAL [24X]
		FOR RTD TYPE (2-, 3-, 4- WIRE)
		0 Resistance 1 RTD 385 2 RTD 392 3 RTD 120 4 Cn 10
		FOR REAL-TIME CLOCK & TIMER
		0 HRS:MIN:SEC 1 HRS:MIN 2 - 3 - 4 1 Second Count UP Timer 5 1 Second Count DOWN Timer 6 - 7 -
		FOR SMART INPUT MODULE
		0 Output Register 1 1 Output Register 2 2 Output Register 3 3 Output Register 4 4 Output Register 5 5 Output Register 6 6 Output Register 7 7 Smart Input Module Register 3 Code Setup

Note 7:
For future development.

See *I-Series Input Modules Guide (Z87)* for procedures to set up a quad input module.

START HERE

CONFIGURE CH4 FUNCTIONS

Step 1

Enter Brightness Mode

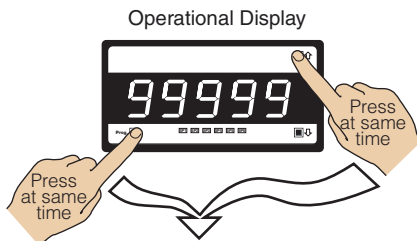

Step 2

Pass Brightness Mode, Calibration Mode, and Codes 1 to 5 and enter Code 6

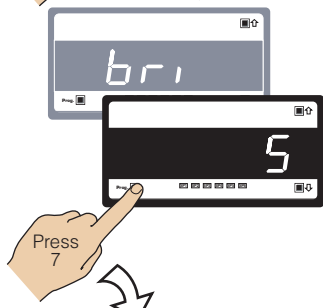

Step 3

Set Code 6 to [01X]:
 1st Digit = 0 Selects direct display of CH4 processed signal
 2nd Digit = 1 Selects voltage, current
 3rd Digit = X Not relevant

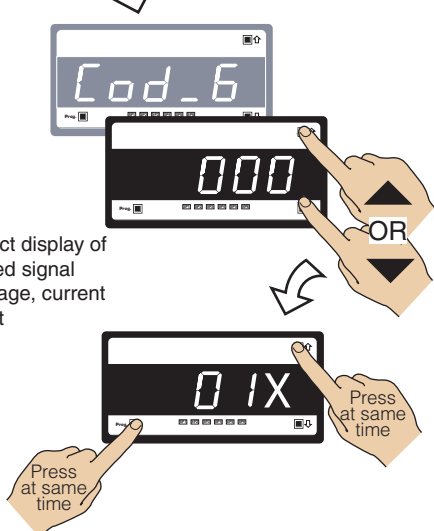

Step 4

Save CH4 setting

From Step 4

Step 5

Exit Code 7. Return to Operational Display

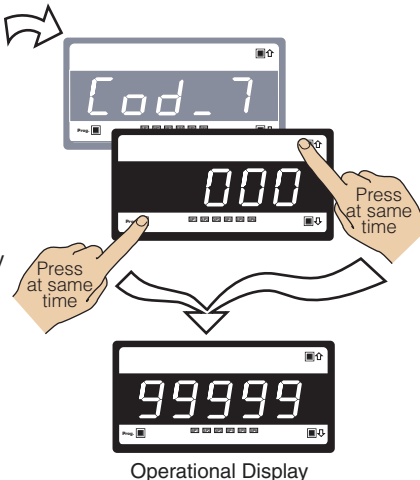

Press **P** 57763 000 Use the **↑** **↓** buttons to set the required smart input module code (0 to 37). See *I-Series Input Module Guide (Z87)* for code details.

[Code 7] - Result Processing

The third digit of Code 7 performs various math functions between channel 1 and channel 2 and stores this data in the result register.

The data in the result register can then be further processed by the selections made in the 1st and 2nd digits.

FIRST DIGIT	SECOND DIGIT	THIRD DIGIT
CODE 7 – RESULT PROCESSING		
RESULT PROCESSING 0 Direct Display of Result as per processing performed in 2nd or 3rd digit 1 Square Root of Result 2 Inverse of Result 3 -	32-POINT LINEARIZATION FOR RESULT 0 No Linearization on Result 1 32-point Linearization on Result using Table 1 2 32-point Linearization on Result using Table 2. <i>See Note 5</i> 3 32-point Linearization on Result using Table 3. <i>See Note 5</i> 4 32-point Linearization on Result using Table 4. <i>See Note 5</i> 5 125-point Linearization on Result (Tables 1 to 4 cascaded). <i>See Note 5</i> 6 32-point Linearization on Result (Tables 1 to 4 selected from the rear of the meter). The selected table is not available if CH2, CH3, or CH4 is operating in the analog mode. CH1 must be set to Voltage, Current in Code 2 [X0X]. <i>See Note 5</i> 7 -	MATHS FUNCTIONS FOR RESULT 0 Result Register not Updated 1 pH Meter (CH1 = Tbuff, CH2 = pH) 2 Result = CH1, Setpoint 2 = CH2 3 Result = CH1 + CH2 4 Result = CH1 - CH2 5 Result = (CH1 x 20 000)/CH2 6 Result = CH1 x CH2/10 000 7 Result = CH1

Example Procedure:

Configure Code 7 to add the input of CH1 and CH2 and directly display the result by setting Code 7 to [003].

See I-Series Input Modules Guide (Z87) for procedures to set up a dual, triple, or quad input module.

START HERE

CONFIGURE RESULT PROCESSING

Step 1

Enter Brightness Mode

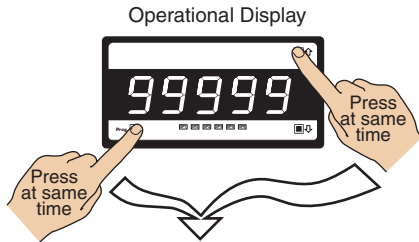

Step 2

Pass Brightness Mode, Calibration Mode, and Codes 1 to 6 and enter Code 7

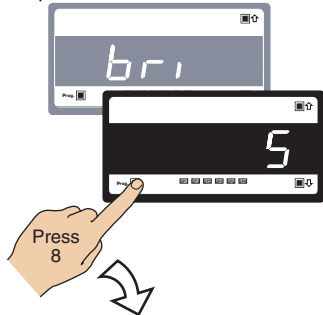

Step 3

Set Code 7 to [003]:
 1st Digit = 0 Selects direct display of result
 2nd Digit = 0 Selects no linearization on result
 3rd Digit = 3 Selects result = CH1+CH2

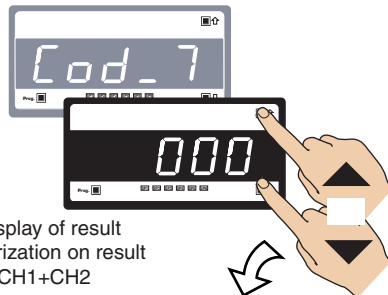

Step 4

Save CH1 & CH2 Result Processing setting

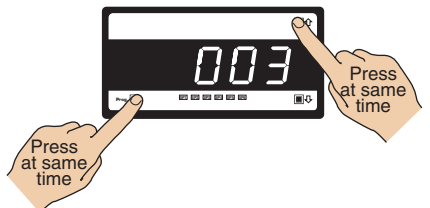

From Step 4

Step 5

Exit Code 8. Return to Operational Display

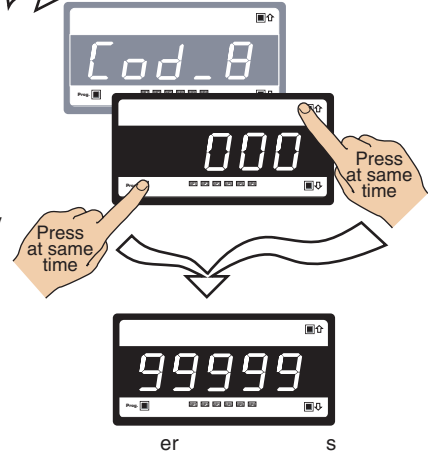

Linearization Table Notes

A base meter with 4 kB memory installed has a single 32-point programmable linearization table available.

For four 32-point programmable linearization tables to be available, the meter requires at least 32 kB of memory to be installed.

Meters with 4 kB Memory

In base meters with 4 kB memory, set up Table 1 in the Calibration Mode to [24X]. This means that Table 1 is available to be applied to:

- CH1 – Selected in Code 3.
- CH2 – Selected in Code 4.
- CH3 – Selected in Code 5.
- CH4 – Selected in Code 6.

Meters with 32 kB Memory

In base meters with 32 kB or more memory, each of the four tables (Tables 1 to 4) are set up in [24X] of the Calibration Mode by selecting the appropriate table number. This means that the four tables are available for the four channels as follows:

- CH1 – All four tables selected in Code 3.
- CH2 – All four tables selected in Code 4.
- CH3 – Table 3 selected in Code 5.
- CH4 – Table 4 selected in Code 6.

[Code 8] - Data Logging & Print Mode

Up to 4000 samples can be logged within the meter in the cyclic or linear FIFO mode and saved for later downloading to a PC, using a terminal evaluation program, or printing directly to a serial printer.

Data logging can be triggered (activated) from a setpoint, the program button, or from an external switch. See the 3rd digit in the diagram below.

Data from up to four selectable registers can be logged with one of the following printer or spreadsheet style time and date stamps. All time and date stamps are generated from an optional real-time clock (see the 2nd digit in the diagram below):

- No time stamp.
- Month - Day - Year. Hours:Minutes:Seconds.
- Day - Month - Year. Hours:Minutes:Seconds.
- Hours:Minutes:Seconds.

Printer style time and date stamps have a carriage return and line feed. Spreadsheet style time and date stamps are continuous on a single line.

See *Serial Communications Module Supplement (NZ202)* for full details on the Data Logging and Print Mode Options.

FIRST DIGIT	SECOND DIGIT	THIRD DIGIT
CODE 8 – DATA LOGGING AND PRINT MODE OPTIONS		
DATA LOG BUFFER TYPE	DATE & TIME STAMP OPTIONS	LOG OR PRINT TRIGGER
0 No Data Logging 1 Cyclic Buffer 2 Linear FIFO Buffer. 3 Reset Buffer Number to 0. <i>Note:</i> <i>Setting Code 8 to [3XX] resets the data log buffer to 0. Once reset, Code 8 must be set back to the required data log buffer setting.</i>	0 Printer Format – No time stamp with print/log 1 Printer Format – Time stamp format 1 [Mth-Day-Yr Hrs:Min:Sec] (with <CR><LF>) 2 Printer Format – Time stamp format 2 [Day-Mth-Yr Hrs:Min:Sec] (with <CR><LF>) 3 Printer Format – Time stamp format 3 [Hrs:Min:Sec] (with <CR><LF>) 4 Spreadsheet Format – No time stamp with print/log 5 Spreadsheet Format – Time stamp format 1 [Mth-Day-Yr Hrs:Min:Sec] 6 Spreadsheet Format – Time stamp format 2 [Day-Mth-Yr Hrs:Min:Sec] 7 Spreadsheet Format – Time stamp format 3 [Hrs:Min:Sec] ALL ABOVE ARE REAL-TIME CLOCK OPTIONS	0 No trigger 1 Trigger on Demand from PROGRAM Button 2 Trigger on Demand from F1 Button 3 Trigger on Demand from F2 Button 4 Trigger on Demand from HOLD Pin 5 Trigger on Demand from LOCK Pin 6 - 7 - <i>Note:</i> <i>Log and/or print will only trigger if enabled.</i>

[Code 9] - Functions for Digital Input Pins

The TEST, HOLD, and LOCK pins are located at the rear of the meter to accommodate external switched digital inputs. When switched to the COMMON pin, they can be programmed in Code 9 to perform remote resetting functions to add to the functionality of the meter.

Note:

CAPTURE, HOLD, and LOCK pins can be a setpoint activation source. See Setpoint Programming mode.

FIRST DIGIT	SECOND DIGIT	THIRD DIGIT
CODE 9 – FUNCTIONS FOR DIGITAL INPUT PINS		
DISPLAY TEST PIN	HOLD PIN	LOCK PIN
0 Display test only 1 Reset Counter Channel 1 and Sub-total at Power-up 2 Reset Counters Channel 1, 2, 3, 4, Total 1, and Total 2 at Power-up 3 Reset Total 1, and Total 2 at Power-up	0 Display Hold 1 Reset Channel 1 2 Reset Total 1 and Total 2 3 Reset Total 2 4 Reset Peak, Valley 5 Reset Tare 6 Set Tare 7 Unlatch (de-energize) all Setpoints	0 Key Lock 1 Reset Channel 1 2 Reset Channel 2 3 Reset Channel 3 4 Reset Channel 4 5 Reset Tare 6 Reset Total 7 Unlatch (de-energize) all Setpoints

Setpoint Programming Mode

All setpoint activation and control settings are selected and configured using the front panel buttons in the **setpoint programming mode**. Or, software configured via the **meter configuration utility program** if the meter is connected to a PC through the serial port. The meter has six software driven setpoints, independently configured to operate within the total span range of the meter and the selected input module.

Relay Output Modules

Five standard relay output module options provide a selection of 20 relay configuration options for 320 Series meters.

Three electromechanical relay output modules support a combination of 5 A Form A and 10 A Form C relays providing 12 configuration options. A solid state relay (SSR) output module supports 400 V, 210 mA DC SSRs and another SSR output module supports 400 V, 140 mA AC / DC SSRs providing a further eight configuration options.

A 22 opto-isolated I/O plug-in module can support six inputs and up to 16 outputs. The standard plug-in module has six inputs and six outputs that can be extended to 16 outputs with a 10 output add-on board.

320 Series Relay Output Module Options

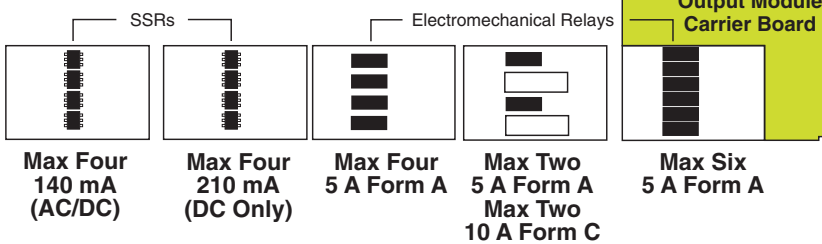

Optional Opto-isolated 22 I/O Plug-in Module

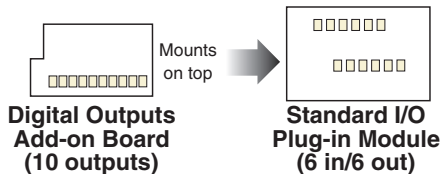

Setpoint Programming Mode

See the *Setpoint Programming Mode Logic Diagram* opposite.

The setpoint programming mode is entered by pressing the meter's **P** and **↓** buttons at the same time.

Setpoint Activation Values

Each setpoint activation value is individually programmed. Setpoint activation values can be set within the total span range of the meter and the selected input module.

Setpoint and Relay Control Settings

See the *Setpoint and Relay Control Settings diagram* on Pages 42 and 43.

The control settings provide access to the following setpoint and relay functions for configuration using the meter's 1st, 2nd, and 3rd digits:

- **1st Digit** – Relay Energize Functions.
- **2nd Digit** – Setpoint Activation Source.
- **3rd Digit** – Setpoint Delay, Timer, and Reset and Trigger Functions.

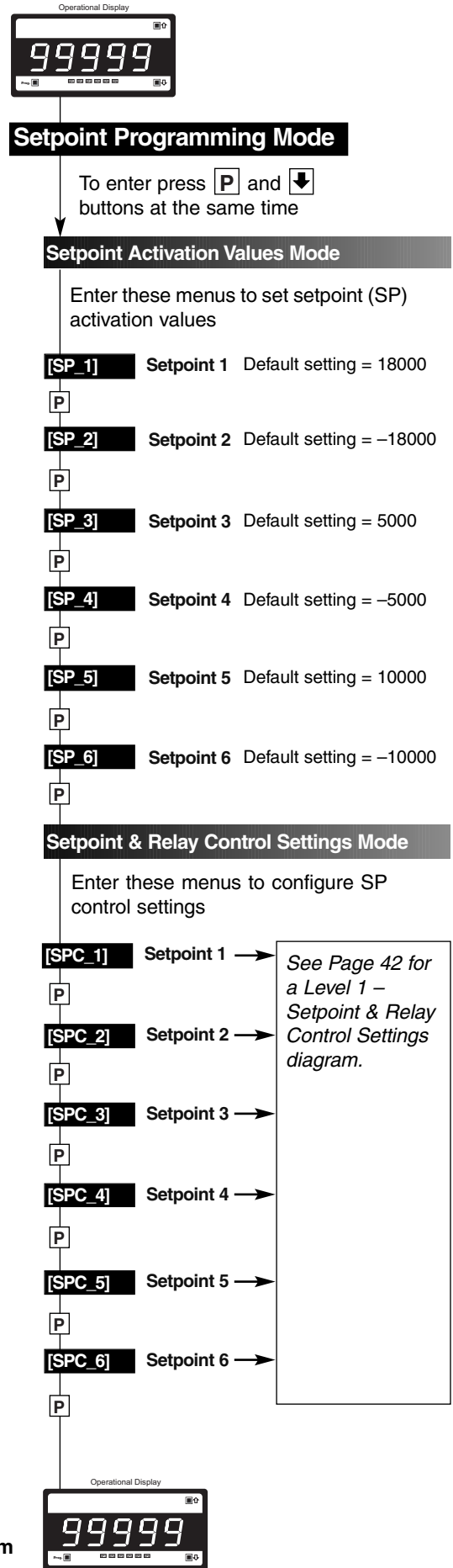

Setpoint Mode Logic Diagram

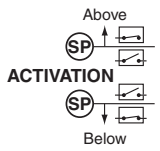

Relay Energize Functions

All setpoints activate at the setpoint value. All relays/setpoints are programmable to energize above or below the setpoint value.

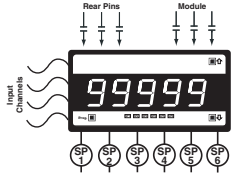

Setpoint Activation Source

Setpoints activate from any input channel, selected meter register, or external switched inputs (digital input pins).

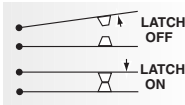

Setpoint Latching

Setpoints can be programmed in relay latching modes.

SP TRIGGER OPERATES ON:

- MAKE EDGE
- BREAK EDGE
- MAKE & BREAK EDGE
- EVERY SAMPLE PERIOD

SP RESET SELECTED REGISTER

SP TRIGGER PRINT

SP TRIGGER LOG DATA

Setpoint Reset & Trigger

Setpoints can be programmed to reset selected registers, or be manually reset. They can also trigger a data print or a data log.



Setpoint Tracking

Setpoint tracking can be applied to setpoints configured in the hysteresis, deviation, or PID modes.



Display Flashing

Display flashing can be applied to setpoints configured in the hysteresis or deviation modes.

Each setpoint can be programmed to make the display flash on and off while the setpoint is active, and keep it flashing until the setpoint de-activates.

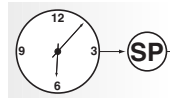

Real-time Clock Option

Any setpoint can be programmed to operate from the real-time clock option.



Data Logging

Any setpoint can be programmed to log data within the meter (up to 4000 samples).

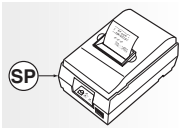

Data Printing to Serial Printer

Any setpoint can be programmed to send data directly to a serial printer.

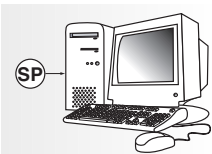

Data Printing to PC

Any setpoint can be programmed to send data directly to a connected PC.



Hysteresis



Deviation

Hysteresis or Deviation

Each relay can operate in a hysteresis or deviation mode.

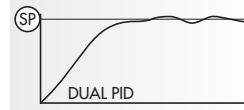

PID Control Settings

The PID (proportional, integral, derivative) control function provides exceptional control stability during control process applica-

tions. PID control is available from the following outputs:

- Setpoint / relay output.
- Analog output.
- Relay and analog output at the same time.

PID control from the setpoint / relay output is available from SP1 and SP2 only.

There are two PID control outputs available via the analog output:

- PID1 – stored in register 50.
- PID2 – stored in register 51.

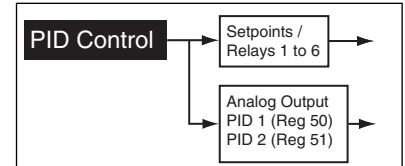

Timer Modes

Each setpoint can be programmed to operate the relay in one of the following seven resident timer modes:

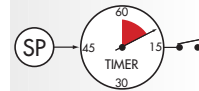

Normal Mode Timer

Single actuation, delay-on-make (DOM) and delay-on-break (DOB).

Normally OFF/Pulsed ON Timers

Repeat ON Mode Timer – multiple actuation, programmable off- and on-time.

Pulse ON Mode Timer – single actuation, programmable DOM and maximum on-time.

1-Shot ON Mode Timer – single actuation, programmable DOM and minimum on-time.

Normally ON/Pulsed OFF Timers

Repeat OFF Mode Timer – multiple actuation, programmable off- and on-time.

Pulse OFF Mode Timer – single actuation, programmable DOB and maximum off-time.

1-Shot OFF Mode Timer – single actuation, programmable DOB and minimum off-time.

Hysteresis or Deviation

Each setpoint can be individually programmed to energize the relay in the hysteresis or deviation mode, with or without initial startup inhibit.

Hysteresis (deadband) is the programmable band above and below the setpoint value that determines when and for how long the relay is energized or de-energized. The setpoint can be programmed to energize the relay above or below the setpoint value.

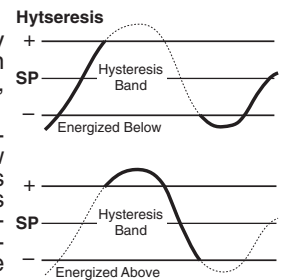

The hysteresis setting can be any value between 0 and 65535 counts. The number of counts selected act both positively and negatively on the setpoint, forming a hysteresis band around the setpoint.

For example, if the setpoint setting is 500 counts and the hysteresis setting is 10 counts, the hysteresis band around the setpoint setting is 20 counts, starting at 490 counts and ending at 510 counts.

Note:

If hysteresis is set with ZERO counts, the relay energizes AT or ABOVE the setpoint value.

Setpoint Programming Mode continued

Deviation (passband) is the programmable band around the setpoint in which the setpoint can be programmed to energize the relay inside or outside the deviation band.

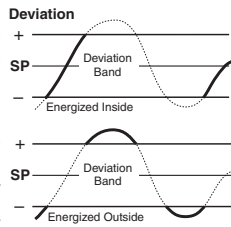

The deviation setting can be any value between 1 and 65535 counts. The number of counts selected act both positively and negatively on the setpoint, forming a deviation band around the setpoint.

For example, if the setpoint setting is 1000 counts and the deviation setting is 35 counts, the deviation band around the setpoint setting is 70 counts starting at 965 counts and ending at 1035 counts.

Initial Start-up Inhibit.

On power-on, start-up inhibit prevents the relay from energizing on the first setpoint activation cycle. Depending on how the meter has been programmed, initial start-up inhibit either functions during a falling input signal, or during a rising input signal.

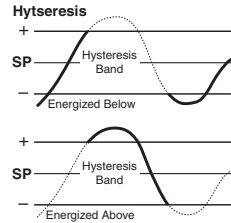

Relay Time Control Modes

The following time control mode settings can cover almost every relay timer application.

All setpoints can be individually programmed to operate a relay in one of the following time control modes above or below the setpoint value.

Normal Mode

This mode individually programs a relay's setpoint with delay-on-make (DOM) and delay-on-break (DOB) settings.

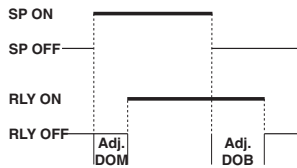

Normally OFF / Pulsed ON Modes

These are delay modes where the relay is **normally off** and **pulses on** when the setpoint activates.

Repeat ON Mode

Multiple actuation, programmable **on** and **off** time settings.

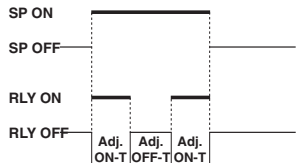

Pulse ON mode (Programmable ON-time)

Single actuation, programmable **DOM** and **on time** settings.

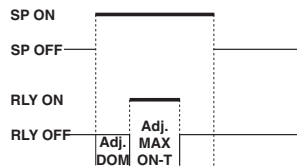

1-Shot ON mode (Programmable Minimum ON-time)

Single actuation, programmable **DOM** and **minimum on time** settings.

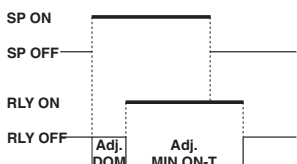

Normally ON / Pulsed OFF Modes

These are delay modes where the relay is **normally on** and **pulses off** when the setpoint activates.

1-Shot OFF mode (Programmable Minimum OFF-time)

Single actuation, programmable **minimum off time** and **DOB** settings.

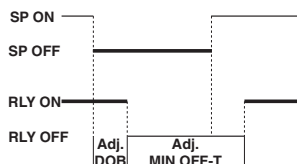

Pulse OFF mode (Programmable OFF-time)

Single actuation, programmable **off time** and **DOB**.

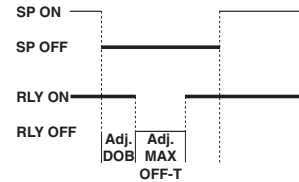

Repeat OFF Mode

Multiple actuation, programmable **off** and **on time** settings.

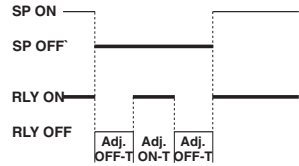

Each setpoint can be individually configured for basic to advanced operations in the following three levels. Each operational level is designed to provide only the required relevant setpoint and relay functions.

The modes at Level 2 and Level 3 can be set to OFF for each individual setpoint, ensuring that no other functions are programmed to influence the setup.

Level 1 Setpoint & Relay Basic Mode

This is an easily programmable mode for users who require the following basic setpoint and relay functions:

First Digit – Relay Energize Functions

Relays programmed to energize above or below the setpoint value.

Second Digit – SP Activation Source

Setpoints programmed to activate from selectable meter registers or one of six external switched inputs.

Third Digit – Setpoint Latching

Relays programmed with latching and manual reset options.

Level 2 Setpoint & Relay Intermediate Mode

Level 2 uses all Level 1 functions and is further extended by the following programmable modes. The functionality of the relay energize functions are extended by allowing the relays to be programmed with or without initial start-up inhibit.

Hysteresis, Deviation & PID Mode

This mode adds extra functionality to the basic mode by providing programmable hysteresis or deviation settings for all setpoints, or PID control from setpoints SP1 and SP2.

Timer Modes

These modes add even more functionality to the basic and intermediate mode by providing each setpoint with a choice of one of seven resident programmable timers.

Level 3 Setpoint & Relay Advanced Mode

Level 3 uses all Level 1 and Level 2 functions combined with reset and trigger functions to provide an extremely powerful advanced mode.

Level 3 enables you to program all setpoints individually for operations normally requiring sophisticated controllers.

Level 1 - Basic Mode - Programming Procedures

Example Procedure:

The following procedure describes how to program setpoint 1 (SP1) for the following **Level 1** setpoint and relay functions:

- SP1 to activate from Channel 1 (CH1).
- Relay to energize above or below SP1 value.
- Relay to latch with manual relay reset.

See *Setpoints and Relays Supplement (NZ201)* for procedures to program all setpoint and relay operational levels (Level 1 to Level 3). (See page 3 for more information).

START HERE

CONFIGURE LEVEL 1 SETPOINT & RELAY FUNCTIONS

Step 1

Enter Setpoint Programming Mode

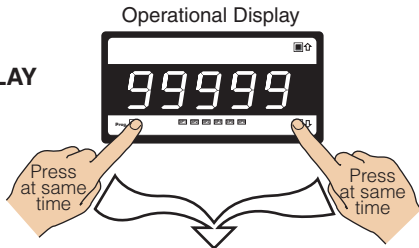

Step 2

Adjust setpoint 1 (SP1) activation value to e.g. 500 counts

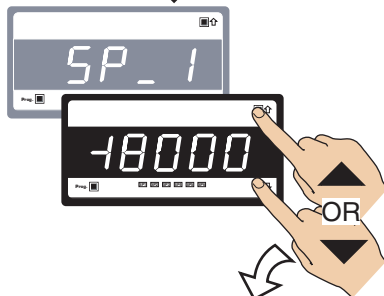

Step 3

Save SP1 activation value setting

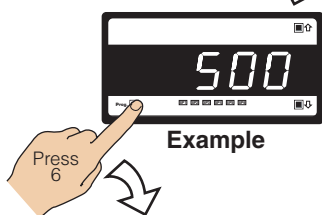

Step 4

Set SPC_1 to [013]:
 1st Digit = 0 Energize above SP1 value or 1 to energize below SP1 value
 2nd Digit = 1 Select source for SP1
 3rd Digit = 3 Relay latching with manual reset

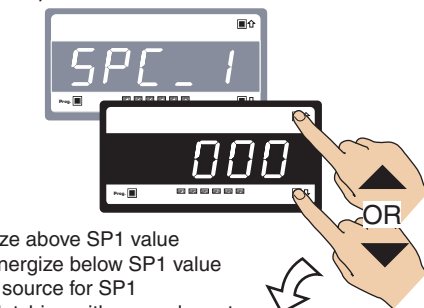

Step 5

Enter SP1 source sub-menu

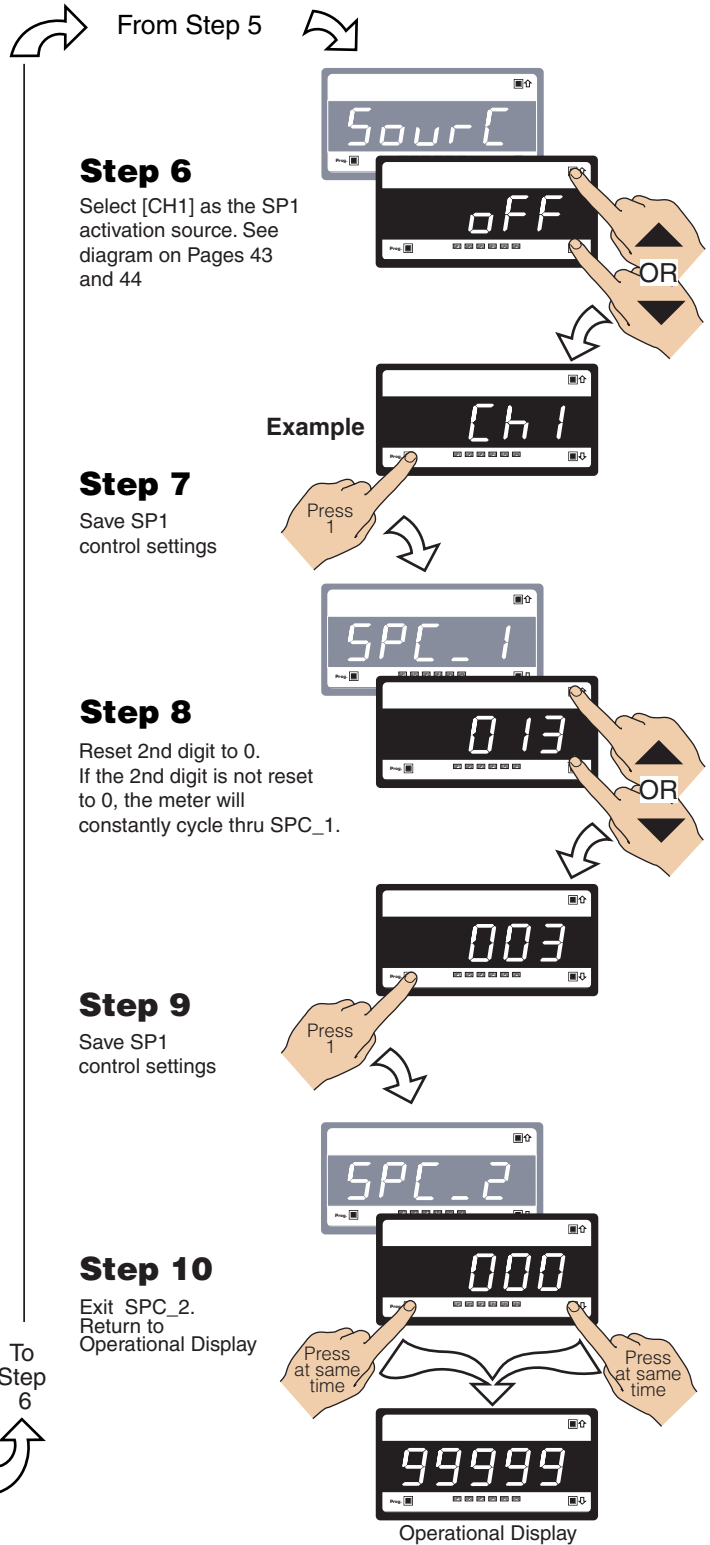
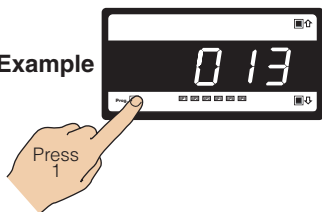

Programming tip

All required setpoint activation values (SP1 to SP6) can be adjusted before programming setpoint and relay control functions. See *Setpoint Mode Logic Diagram* on Page 42.

Setpoint Programming Mode continued

Setpoint & Relay Control Settings Diagram

The diagram below and continued on Page 43 shows the 1st, 2nd, and 3rd digit control settings for the setpoints and relays.

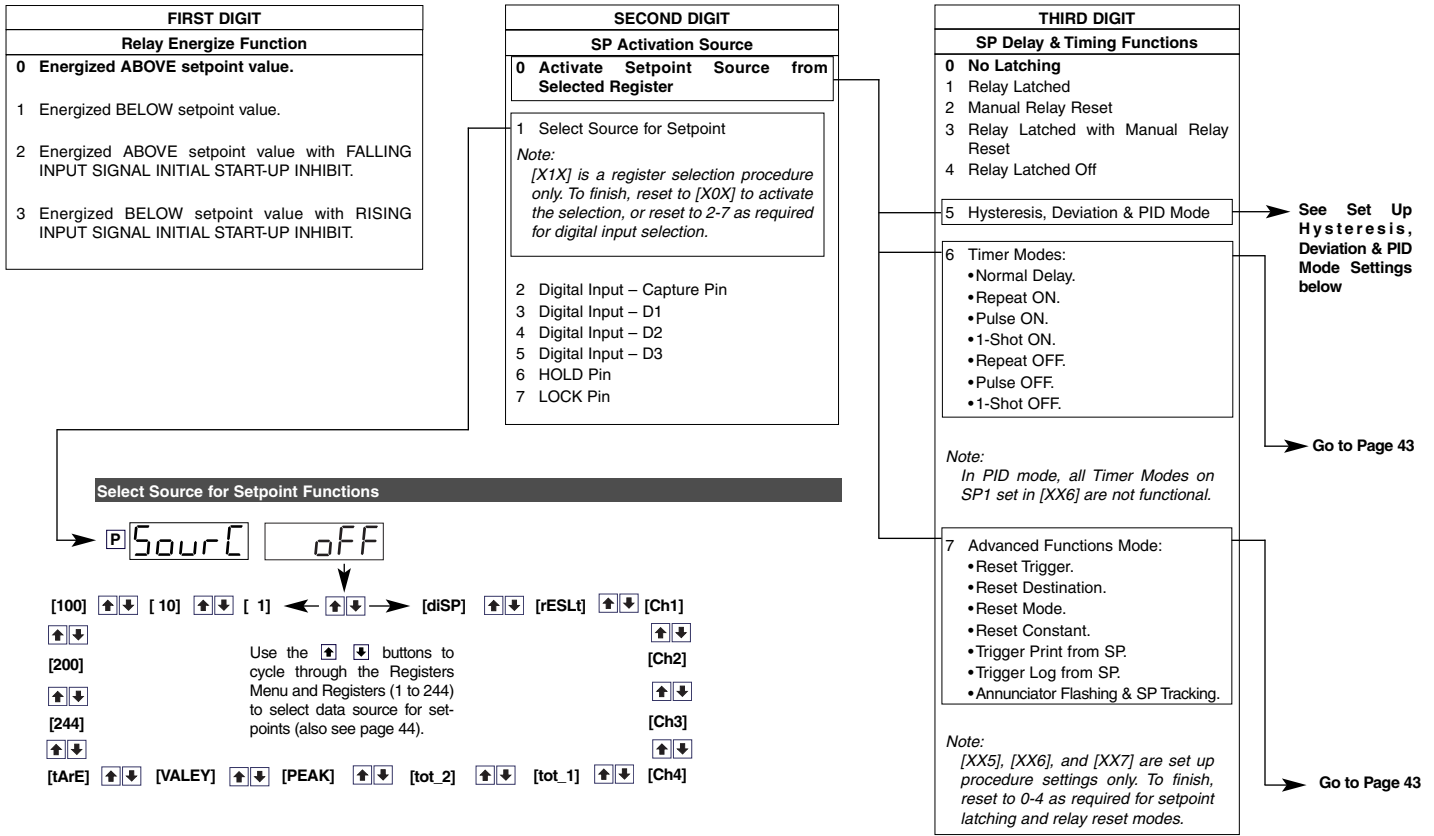

Set Up Hysteresis, Deviation & PID Mode Settings



Programming Tip

If you do not require any of the functions in this mode, ensure it is set to:

Mode off

Third digit set to [XX5]

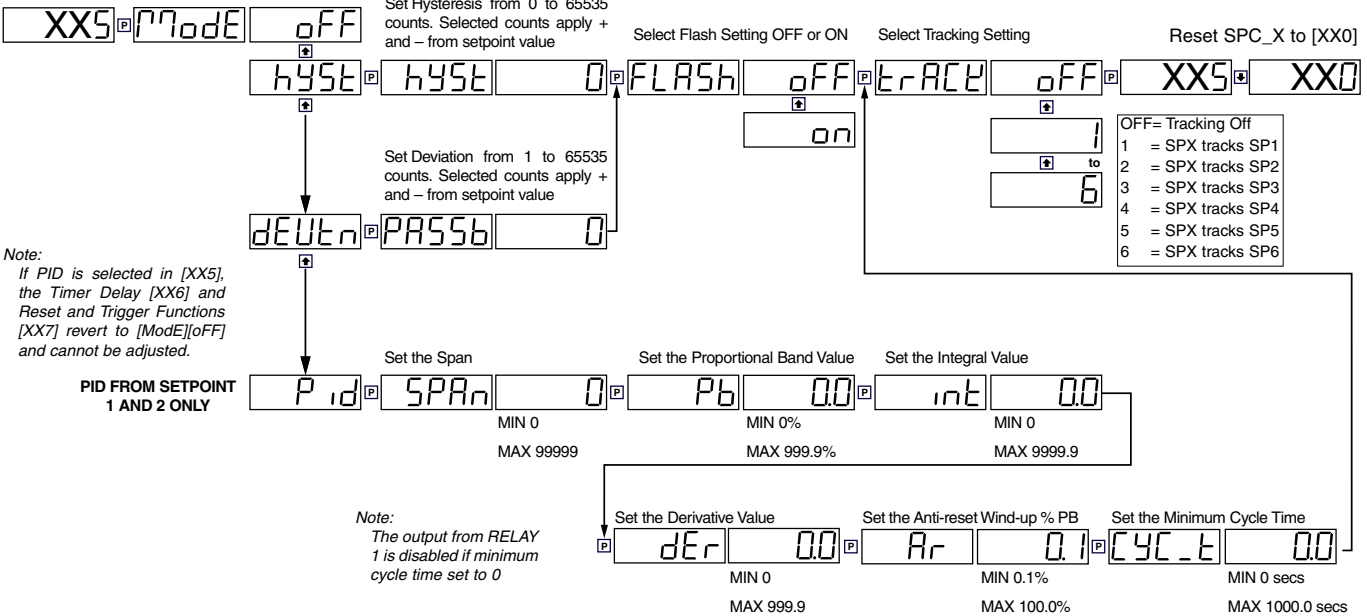

Setpoint Programming Mode continued

Set Up Timer Delay Settings



Programming Tip

If you do not require any of the functions in this mode, ensure it is set to:

trig OFF

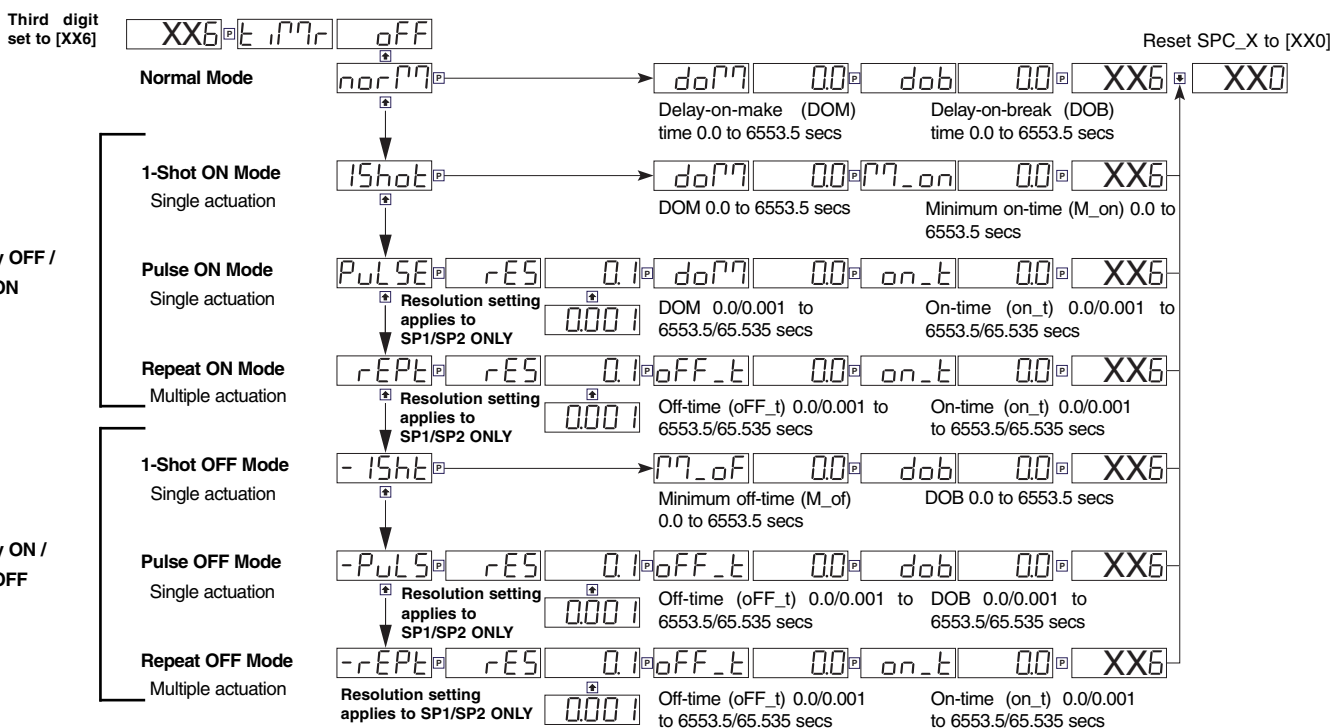

Set Up Register Reset and Setpoint Trigger Functions

Third digit set to [XX7]

Select Trigger Setting

trig OFF

Select Reset Destination Register

MODE DEST OFF

Selecting [OFF] in the Destination Register Reset Setup takes you to Setpoint Print Trigger Setup

Select Print Triggered by Setpoint

Print OFF

Select Log Triggered by Setpoint

Log OFF

Reset SPC_X to [XX0]

XX7 XX0

- [brEAK] [244 to 1]
 - [both] [tArE]
 - [LEVEL] [VALEy]
 - [PEAK] [Ch1]
 - [tot_2] [Ch2]
 - [tot_1] [Ch3]
 - [Ch4]
- Use the [↑] and [↓] buttons to cycle through the Registers Menu and Registers (1 to 244) to select which destination register is to be reset by a setpoint (also see page 44).

Select Reset Mode

- Mode Const
- [-S+C]
- [d+C]
- [rEG]

Selecting any destination register takes you to Mode Reset

Select Reset Constant

- RES_C 0
- Sets from 0 to -19999
- Sets from 0 to 99999

Select [rEG] to access the source parameter to select the number of the Modbus register in the meter to be copied to the reset destination register

- [244 to 1]
 - [tArE]
 - [VALEy]
 - [PEAK]
 - [tot_2]
 - [tot_1]
 - [Ch1]
 - [rESLt]
 - [Ch1]
 - [Ch2]
 - [Ch3]
 - [Ch4]
- Use the [↑] and [↓] buttons to cycle through the Registers Menu and Registers (1 to 244) to select which register's contents are to be copied into the destination register by a setpoint (also see page 44).



Programming Tip

If you do not require any of the functions in this mode, ensure it is set to:

trig OFF

Registers That Can Be Selected By Front Panel Push Button Programming

A Tiger 320 Series meter has 6,144 registers which are provided for use by the operating system and the powerful Custom Macro Programming system (see page 11).

40 Manually Selectable Registers

Using the front panel buttons, there are 40 registers that may be selected for use within the following functions:

- **[CodE_1] - Display Configuration [X50]**. Selection of a register as the data source for displays, peak and valley, totalizers and analog outputs. (See pages 26 & 27)
- **Setpoint Control Settings [X1X]**. Selection of a register as the data source for a setpoint. (See Page 42)
- **Setpoint Control Settings [XX7]**. Selection of a destination register that is to be reset by a setpoint with the contents of a selected source register. (See Page 43)
- **Setpoint Control Settings [XX7]**. Select which register's contents are to be copied into the destination register by a setpoint. (See Page 43)

The 40 registers that can be selected as a data source, a reset source or a reset destination for the functions above are shown in the table on the right.

The table shows, in seven columns, the functions where these registers can be used.

Where a register is more likely to be used in a particular function, a closed circle ● is shown in the column. For those functions where a register is less likely to be used, an open circle ○ is shown.

No register number is shown for the first 11 functions, because these 11 functions are identified in the display menu for direct selection by their code names.

When cycling through the Registers Menu and then Registers 1 to 244, the numerical Register Set will increment through each decade in turn, from 1 to 0, while the button is held down. When [200] is reached, [oFF] or [tArE] will be displayed. To select a specific number set, the button should be released and pressed again each time the left most decade displays the desired number for that decade.

To quickly exit the numerical 1 to 244 Register Set, hold the [↓] button down while cycling through the decades, and release it when [oFF] or [tArE] appears.

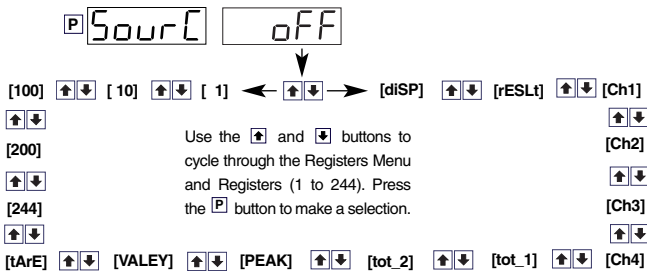

Registers that Should Not be Used

The following registers are contained within the selectable 1 to 244 Register Set, but they should not be selected because they are either reserved for future use, or for use by the operating system only:

15, 38, 47-48, 52-53, 61-64, 123-128, 140-141, 234-244

Any selection of these Registers may cause a malfunction.

Register Functions	Register Numbers	Data Source for Displays	Data Source for Peak & Valley	Data Source for Analog Outputs 1 & 2	Data Source for Totalizers 1 & 2	Data Source for Setpoints	Reset Source	Reset Dest.
Display [diSP]	-		●	●	●	●		
Result [rESLT]	-	●	●	●	●	●	●	●
CH1 [Ch1]	-	●	●	●	●	●	●	●
CH2 [Ch2]	-	●	●	●	●	●	●	●
CH3 [Ch3]	-	●	●	●	●	●	●	●
CH4 [Ch4]	-	●	●	●	●	●	●	●
Total 1 [tot_1]	-	●	●	●		●	●	●
Total 2 [tot_2]	-	●	●	●		●	●	●
Peak [PEAK]	-	○				●	○	●
Valley [VALEY]	-	○				●	○	●
Tare [tArE]	-	○	○	○			○	●
PID Output 1	50	○	○	○		○		
PID Output 2	51	○	○	○		○		
Smart Result 1	54	○	○	○				○
Smart Result 2	55	○	○	○				○
Smart Result 3	56	○	○	○				○
Smart Result 4	57	○	○	○				○
Smart Result 5	58							○
Smart Result 6	59							○
Smart Result 7	60							○
Analog Output 1	83	○				○	○	○
Analog Output 2	84	○				○	○	○
Timer 1	95	○				○	○	○
Timer 2	96	○				○	○	○
Smart Reset Offset 1	121							●
Smart Reset Offset 2	122							●
Clock - Seconds	213					○		
Clock - Minutes	214					○		
Clock - Hours	215					○		
Clock - Days	216					○		
Clock - Date	217					○		
Clock - Month	218					○		
Clock - Year	219					○		
Setpoint Latch	221							●
Relay De-energize	222							●
Zero Offset - Result	227					○		
Zero Offset - CH1	228					○		
Zero Offset - CH2	229					○		
Zero Offset - CH3	230					○		
Zero Offset - CH4	231					○		

Resetting and Incrementing Using Setpoints

Setpoints may be used to reset and/or increment registers. In the example shown on the right, 2 liter soft drink bottles are being filled and packed 12 to a case. Using the setpoint reset and increment feature, the number of bottles and the total number of filled cases is easily calculated and displayed. Totalizer 1 counts from 0 to 2, resets, and repeats. CH 2 counts from 0 to 12, resets, and repeats.

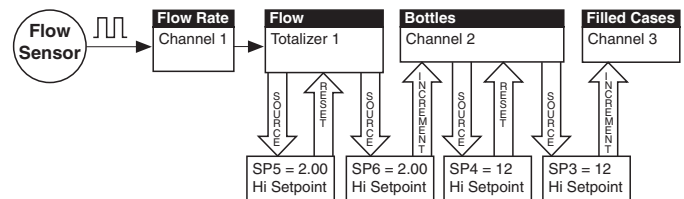

USING SETPOINTS TO INCREMENT AND RESET REGISTERS

Functional Diagram

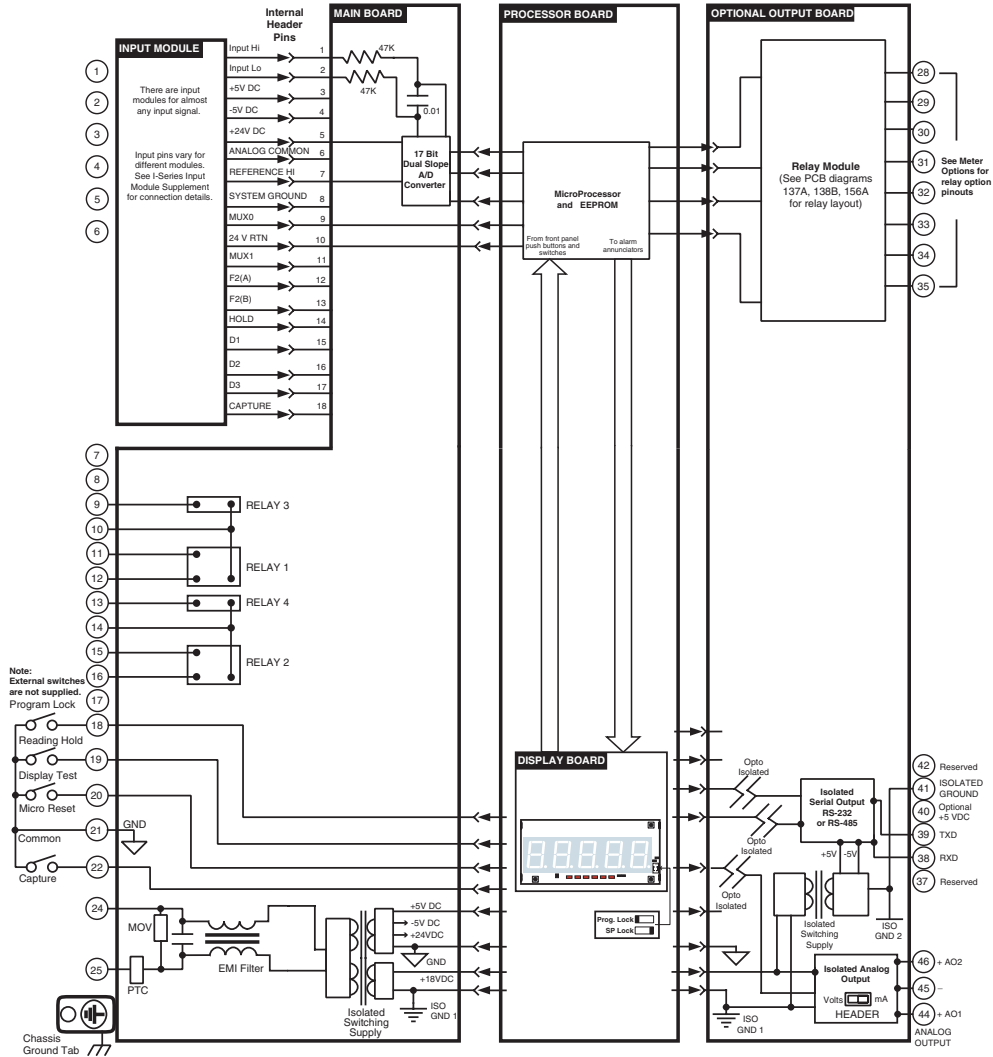

Connector Pinouts

Rear Panel Pinout Diagram

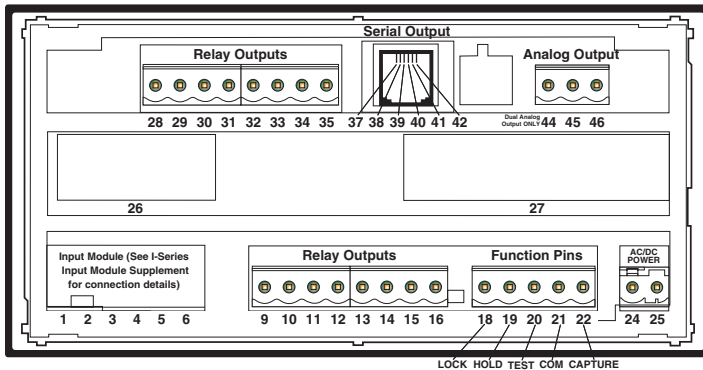

WARNING: AC and DC input signals and power supply voltages can be hazardous. Do not connect live wires to screw terminal plugs, and do not insert, remove or handle screw terminal plugs with live wires connected.

Input Signal – Pins 1 to 6

See the *I-Series Input Modules Guide (Z87)* for connection details of all input modules. On most single input signal conditioners, usually Pin 1 is the signal high pin (Hi +) and Pin 3 is the signal low pin (Lo -).

Function Pins – Pins 18 to 22

Pin 18 – Program Lock. By connecting the PROGRAM LOCK pin to the COMMON pin (pin 11 on the main PCB), the PROGRAM LOCK pin allows the meter's programmed parameters to be viewed but not changed.

Pin 19 – Hold Reading. By connecting the HOLD READING pin to the COM-

NOTE: The meter uses plug-in type screw terminal connectors for most input and output connections and an RJ-6 phone connector for the optional RS-232 or RS-485 serial outputs.

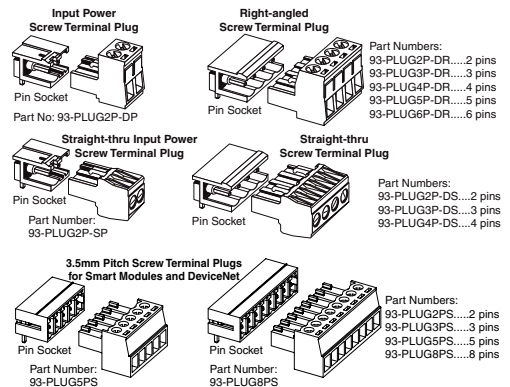

MON pin (pin 11), the HOLD READING pin allows the meter's display to be frozen. However, A/D conversions continue and as soon as pin 9 is disconnected from pin 11 the updated reading is instantly displayed.

Pin 20 – Display Test and Reset. The DISPLAY TEST and RESET pin provides a test of the meter's display and resets the microprocessor when the DISPLAY TEST and RESET pin is connected to the COMMON pin (pin 11).

Pin 21 – Common. To activate the HOLD, TEST and RESET, or LOCKOUT pins from the rear of the meter, the respective pins have to be connected to the COMMON pin.

Pins 24/25 – AC/DC Power Input. These are the pins that supply power to the meter. See Power Supply for details of the standard and optional low voltage power supply.

Chassis Ground Tab. Only on versions with metal sheath casing.

Carrier Board Output Pins

Analog Outputs

- Pin 44 – Positive (+) analog output 1.
- Pin 45 – Negative (-) analog output 1 and 2.
- Pin 46 – Positive (+) analog output 2.

Serial Outputs RS-232 or RS-485



Pin No.	RS-232	RS-485
37	Reserved for future use	Reserved for future use
38	RXD. Received Serial	B (Low)
39	TXD. Transmitted Serial	A (High)
40	+5 VDC to power external converters	+5 VDC to power external converters
41	Isolated Ground	Isolated Ground
42	Reserved for future use	Reserved for future use

Electromechanical Relays

There are 8 relay options available using the relays mounted on the main processor board. The main processor board supports relay combination options using up to four electromechanical relays. A maximum of two 5 A Form A and two 10 A Form C relays. Relay outputs for one to four setpoints can be ordered for factory installation on the main board in any required combination of up to two 10A form C and two 5A form A relays.

		Main / Processor Board							
PIN Numbers		9	10	11	12	13	14	15	16
Maximum 2 groups of 1 x 10A Form C & 1 x 5A Form A Relays using one Common Pin per group		NO3	COM 1&3	NC1	NO1	NO4	COM 2&4	NC2	NO2
		SP3		SP1		SP4		SP2	
		5 A Form A Relay		10 A Form C Relay		5 A Form A Relay		10 A Form C Relay	
Order Code	Options								
	SP3	SP1	SP4	SP2					
R1	5A	-	-	-					
R2	5A	-	5A	-					
R11	-	10A	-	-					
R12	-	10A	-	10A					
R13	5A	10A	-	10A					
R14	5A	10A	5A	10A					
R15	5A	10A	5A	-					
R16	5A	10A	-	-					
		PIN 10 COMMON for SP1, SP3				PIN 14 COMMON for SP2, SP4			

Relay and Logic I/O Modules

Relay Modules with up to two 5A Form A Relays, and up to two 10A Form C Relays

Order Code	Options			
	SP3	SP1	SP4	SP2
OR11	-	10A	-	-
OR12	-	10A	-	10A
OR23	-	10A	5A	10A
OR14	5A	10A	5A	10A
OR15	5A	10A	5A	-
OR16	-	10A	5A	-

Relay Modules with up to 4 Independent 400V (210mA DC only) or (140mA AC/DC) SSRs

Order Code	Options			
	SP1	SP2	SP3	SP4
OR51, OR61	210mA, 140mA	-	-	-
OR52, OR62	210mA, 140mA	210mA, 140mA	-	-
OR53, OR63	210mA, 140mA	210mA, 140mA	210mA, 140mA	-
OR54, OR64	210mA, 140mA	210mA, 140mA	210mA, 140mA	210mA, 140mA

Relay Modules with five or six 5A Form A Relays

Order Code	Options					
	SP1	SP2	SP3	SP4	SP5	SP6
OR45	5A	5A	5A	5A	5A	-
OR46	5A	5A	5A	5A	5A	5A

Relay Modules with up to four 5A Form A Relays

Order Code	Options			
	SP1	SP2	SP3	SP4
OR31	5A	-	-	-
OR32	5A	5A	-	-
OR33	5A	5A	5A	-
OR34	5A	5A	5A	5A

TTL / 5V Output

Order Code	Options					
	SP1	SP2	SP3	SP4	SP5	SP6
OR71	0 to 5V	0 to 5V	0 to 5V	0 to 5V	0 to 5V	0 to 5V

Flash Card Memory Module

Order Code	Options
	OR91

Open Collector Output

Order Code	Options					
	SP1	SP2	SP3	SP4	SP5	SP6
OR72	OC1	OC2	OC3	OC4	OC5	OC6

Opto Isolated I/O Module for External Breakout Box with 6 Outputs & 6 Inputs, or 16 Outputs & 6 Inputs

Order Code	Options		
	NPN Open Collector Setpoint	Macro Setpoint	Sink/Source Logic Input
OR81	6 Outputs	-	6 Inputs
OR82	6 Outputs	10 MACRO Outputs	6 Inputs

Modular Construction

The Tiger 320 Series of 32-bit Programmable Meter Controllers incorporates, in one instrument, all the different functions required by today's automation and process control applications. This is made possible by modular construction, around standard case sizes, built to American, European, and Japanese standards.

The range comes with a wide variety of display options, including 5 or 6-digit numeric or alphanumeric displays, 6-digit LCD displays, and 51 or 101-segment red, green, or tri-color straight and circular bargraphs.

All meters are housed in one of three DIN case sizes, or the popular 4" ANSI case, and provide the ideal solution for your measurement and process control applications.

Modular construction ensures you don't have to pay for unnecessary hardware. Simply order the input and output options to suit your application.

320 Series Base Meter

- Power Supply – standard or optional low voltage.
- Processor.
- Display – red, green, or super bright red LEDs

Input Signal Conditioning Modules

Select from over 120 single, dual, triple, or quad inputs covering almost every input signal type.

Standard Serial Output Carrier Board

Relay Modules

Electromechanical Relays

- Max 6 Form A
- Max 2 Form A, 2 Form C
- Max 4 Form A

Solid State Relays

- DC only
- AC / DC

Opto Isolated I/O Module

- 6 Outputs, 6 Inputs
- 16 Outputs, 6 Inputs

Open Collector / TTL / 5V Output

- 0 to 5V
- 0 to V+

Flash Card Memory Module

- Module with 8 Meg Memory
- Module with 16 Meg Memory

Serial Output Modules

- RS-232 Module*
- RS-485 Module*

*RS-232 and RS-485 modules cannot be used with the optional DeviceNet or Ethernet Carrier Boards.

Analog Output Modules

- 0-20 mA
- 0-10 VDC
- Dual 0-10 VDC

Tiger 320 Series GI Modular Construction

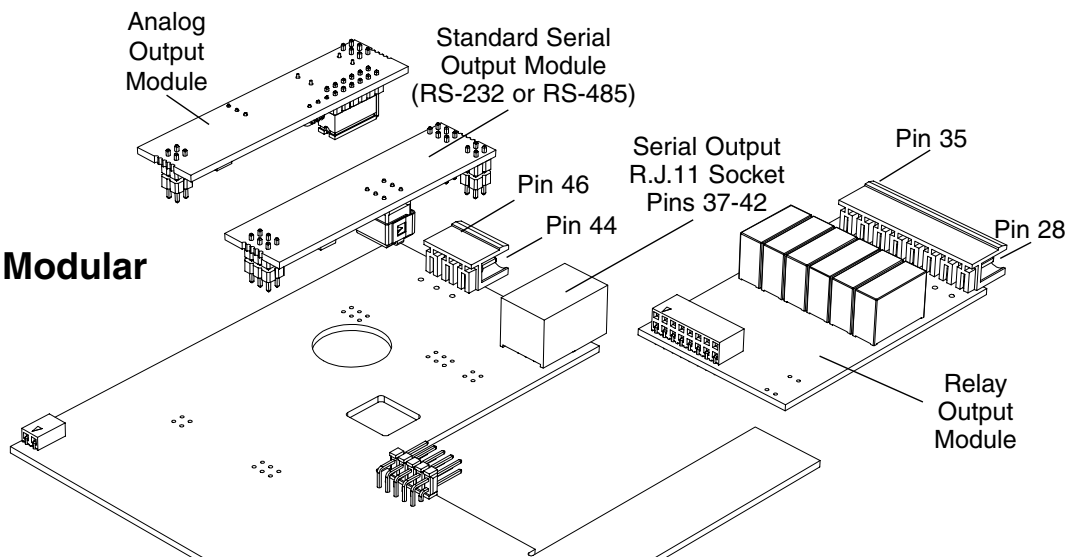

Exploded View of Meter Modular Boards

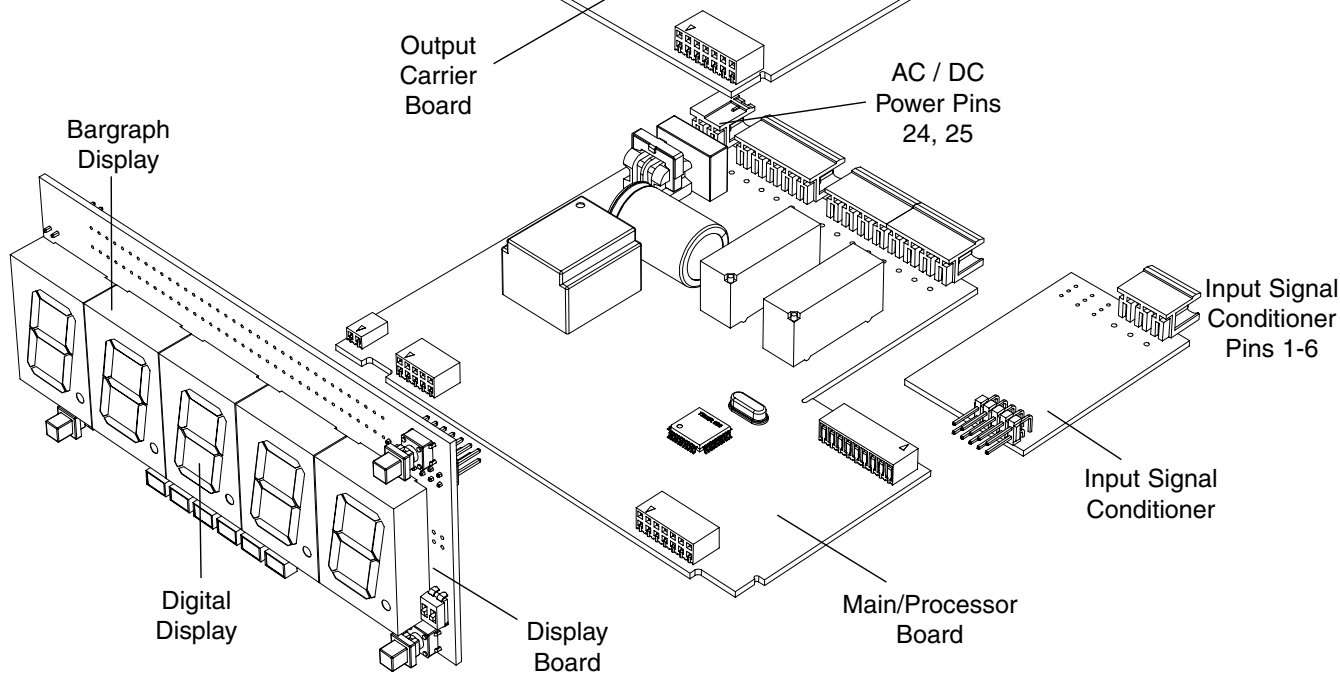

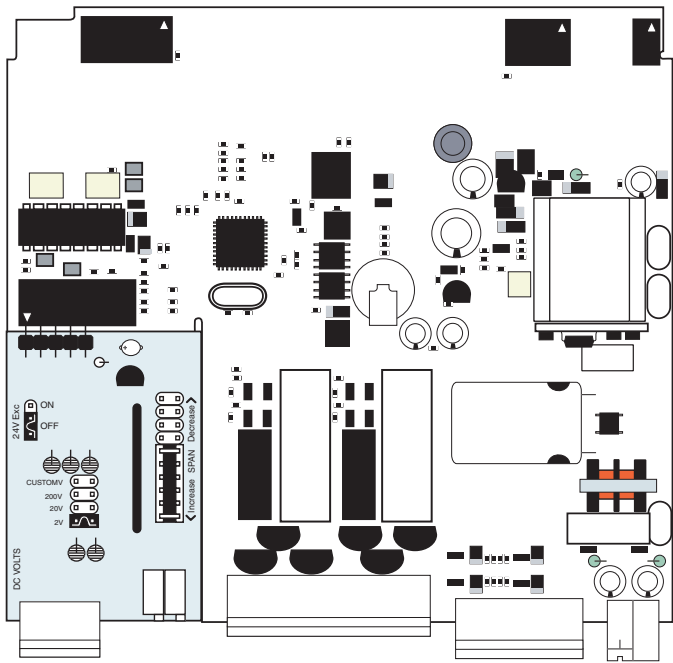

Main PCB*

*Shown with optional Input Signal Conditioning Module (Ordered Separately)

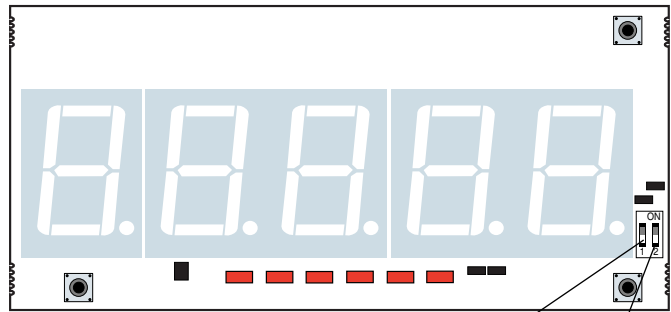

Display Board

SETPOINT LOCKOUT Switch
PROGRAM LOCKOUT Switch

Analog Output Module PCB

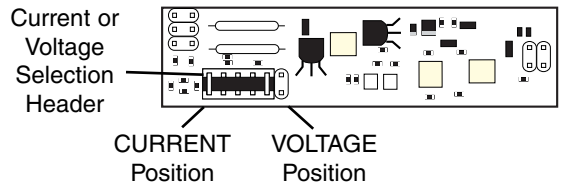

Available in Single (0~4-20mA or 0-10V) or Dual (0-10V & 0-10V)

Standard Serial Output Modules RS-232 or RS-485

Note:

Externally mounted Ethernet compatible communication output modules are available that connect directly to the standard (RS-232 / RS-485) serial module outputs.

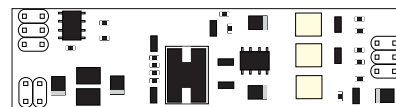

RS-485 Output Module PCB



RS-232 Output Module PCB

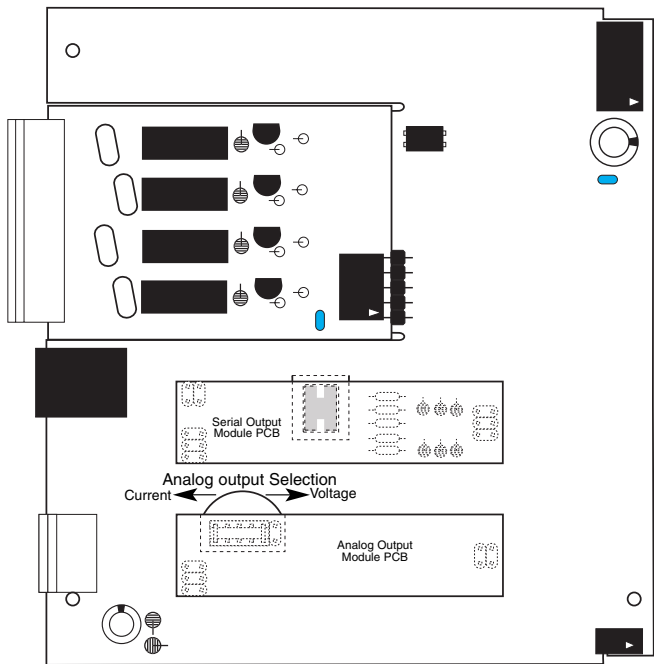

Standard Output Carrier Board*

*Shown with optional Analog Output Module, optional Relay Output Module and a Serial Output Module (RS-232, RS-485 or No Serial Output)

Opto Isolated I/O Modules Connect to External DIN Rail Mounting Breakout Box

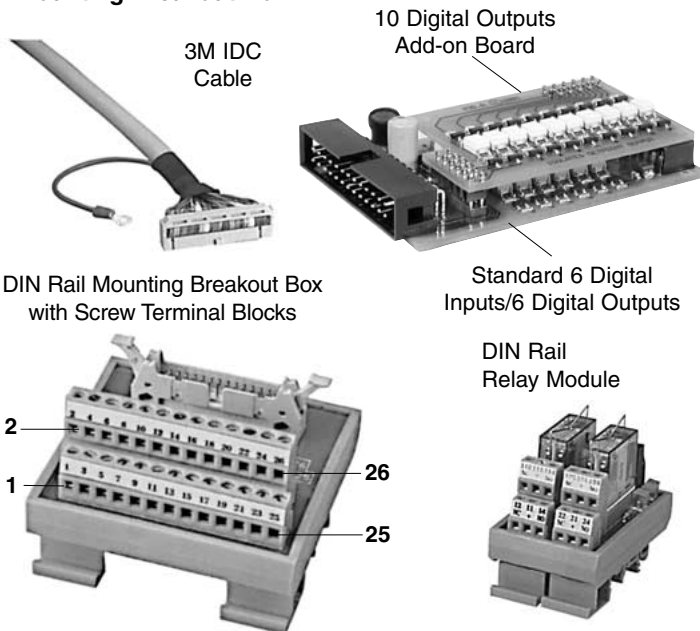

I-Series Input Signal Conditioning Modules continued

Many additional input modules are available and others are constantly being developed. Check with your local distributor or see Texmate's web site at: www.texmate.com for updated information. Pre calibrated **I-Series Input Modules**, that have span or zero potentiometers, **can be interchanged between any I-Series compatible meter**, without recalibration, because all of the analog scaling and reference circuitry is self-contained within the module. Where appropriate, all the standard ranges are designed to be header selectable by the user, and our unique **SPAN ADJUST** Header facilitates **scaling to almost any required engineering unit**. See Input Module Component Glossary for more information.

Unless otherwise specified, we will ship all modules pre calibrated with factory preselected ranges and/or scaling as shown in **BOLD** type. Other pre calibrated standard ranges or custom ranges may be ordered. Factory installed custom scaling and other custom options are also available.

Symbols Indicate Module Compatibility Within Meter Families		
TIGER Family	LEOPARD Family	LYNX Family
TIGER Family	LEOPARD Family	LYNX Family
TIGER Family	LEOPARD Family	LYNX Family
ALL MODELS	SOME MODELS	MODEL SPECIFIC

- * TIGER IT03
*A module code shown below a compatibility symbol indicates another module is available, similar in function, which may be more suited for use with that family.
- ** LYNX FX-B1010
**Modules which are compatible are listed below the Model Specific Symbol.
- Indicates a SMART MODULE. Smart Modules incorporate their own microprocessor and A/D converter. They communicate digitally with the Tiger 320 Operating System. Some also have their own SSR outputs.

IA01: AC Volts Scaled RMS, 200/600V AC

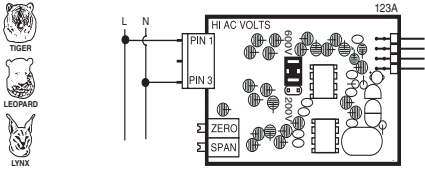

IA02: AC Volts Scaled RMS, 200mV/2V/20V AC

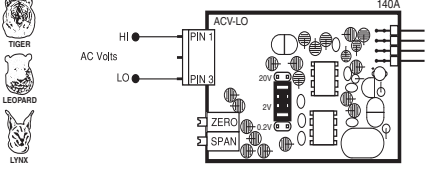

IA03: AC Milliamps Scaled RMS, 2/20/200mA AC

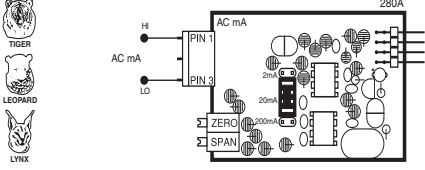

IA04: AC Amps Scaled RMS, 1 Amp AC
IA05: AC Amps Scaled RMS, 5 Amp AC

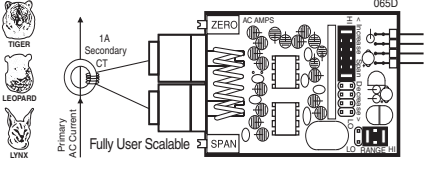

IA06: AC Volts True RMS, 300/600V AC

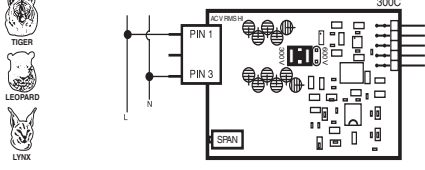

IA07: AC Volts True RMS, 200mV/2V/20V AC

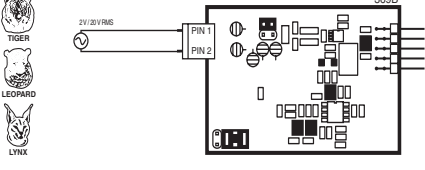

IA08: AC Milliamps True RMS, 2/20/200mA AC

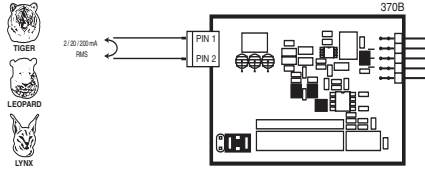

IA09: AC Amps True RMS, 1 Amp AC
IA11: AC Amps True RMS, 5 Amp AC

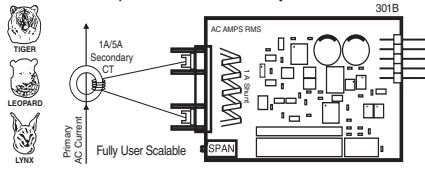

IA10: AC Milliamps, Scaled RMS, 100mV AC

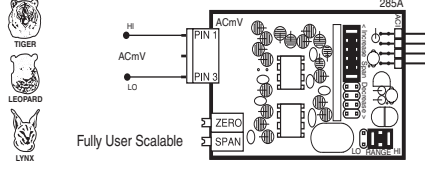

IA12: AC Millivolt RMS Sigma Delta

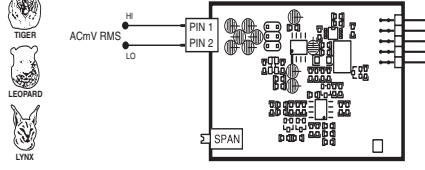

IC02: Quadrature Counter
IC03: Quadrature Counter w/dual SSRs

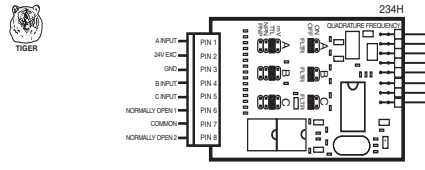

ID01: DC Volts, 2/20/200V/Custom w/24V DC Exc

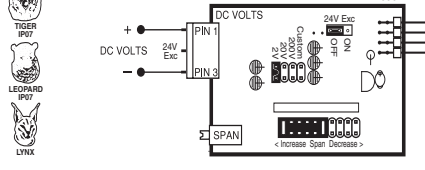

ID02: DC Millivolts, 20/50/100/200mV DC w/24V DC Exc

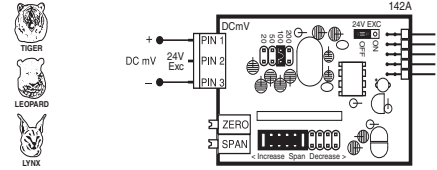

ID03: DC Milliamps, 2/20/200mA DC w/24V DC Exc

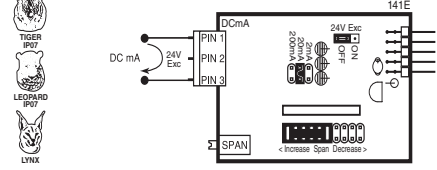

ID04: DC Amps, 5A DC
ID09: DC Amps, 1A DC

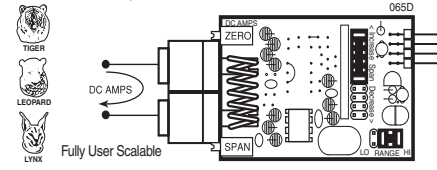

ID05: DC Volts 2/20/200/Custom V DC with Offset and 24V Exc.

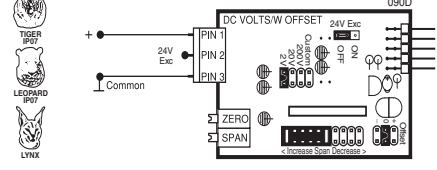

ID06: DC Volts 2/20/200/Custom V DC with External Decimal Select

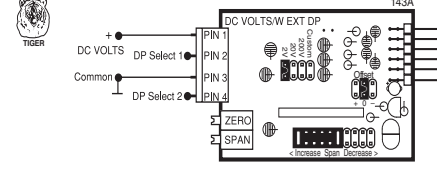

ID07: DC Milliamps, 2/20/200mA DC with Offset and 24V Exc

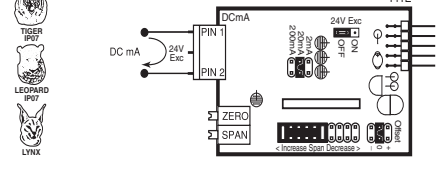

I-Series Input Signal Conditioning Modules continued

ID08: DC Volts, 2/20/200/Custom V DC with External LIN Table Select

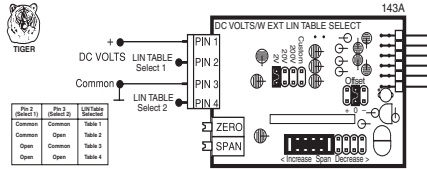

IDC1: Dual UP/DOWN Counter

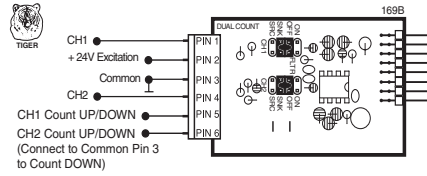

IDD1: Dual DC Volts, 2V DC
IDD2: Dual DC Millivolts, 50mV DC

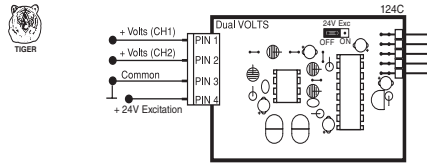

IDD3: Dual DC Milliamps, 2mA DC

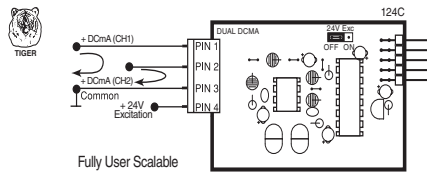

IDD4: Dual Input, DCV and DCmV 2V/50mV DC

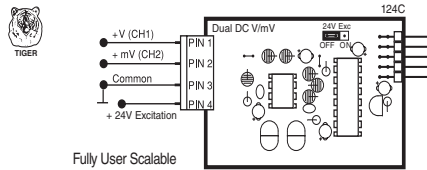

IDD5: Dual Input, DCV and 4 to 20mA 2V/4 to 20mA DC

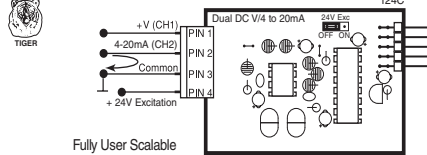

IDD6: Dual Input, DC mV and 4 to 20mA 50mV/4 to 20mA DC

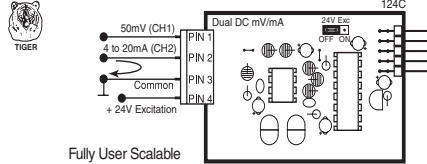

IDF2: Dual Frequency

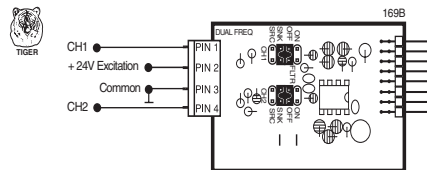

IDP1: Dual Process Loop, 4-20mA

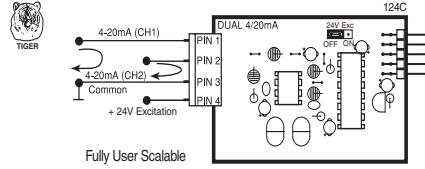

IDP2: Dual Input, 3-wire RTD and 4-20mA

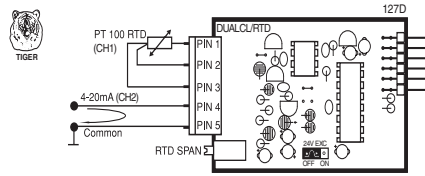

IDP3: Dual Input- Thermocouple (J/K/R/S/T/B/N) and 4 to 20mA

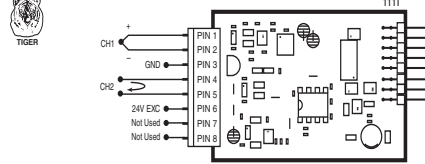

IDR1: Dual Resistance Input, 0.2/2/20KΩ

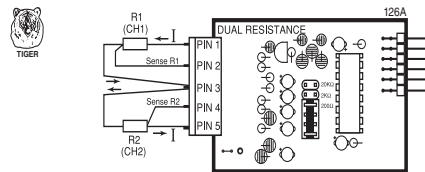

IDS1: Dual Strain Gage Input, 4 wire 2mV/V, 20mV/V

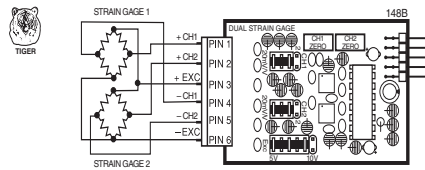

IDS2: Dual Pressure Input, 4 wire 2mV/V, 20mV/V

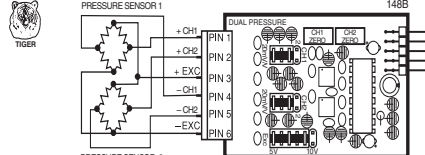

IDS3: Dual Input, Strain Gage and Frequency

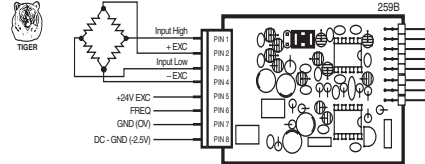

IDT1: Dual Thermocouple (J/K/R/S/T/B/N)

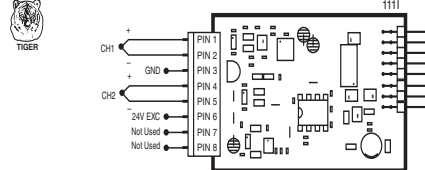

IDT2: Dual RTD Input, 2/3-wire, 100Ω Pt

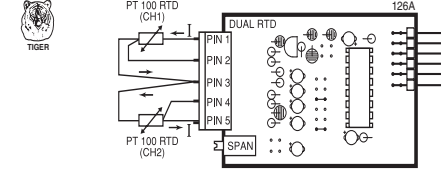

IDT3: Dual Input, 3-wire RTD and DCV

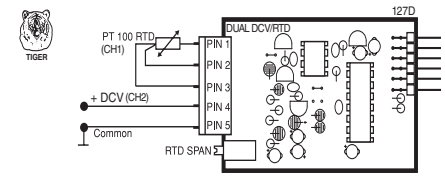

IDT4: Dual Input- Thermocouple (J/K/R/S/T/B/N) and 2VDC Input
IDT5: Dual Input- Thermocouple (J/K/R/S/T/B/N) and 50mV Input

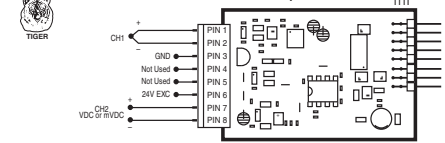

IDT6: Dual Input - Thermocouple and Load Cell

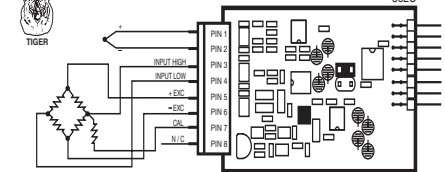

IF06: Line Frequency

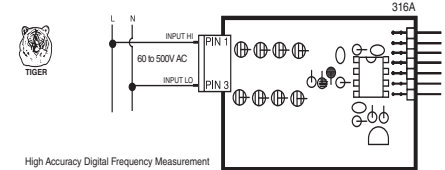

IF10: Univ. Freq. / RPM / UP DOWN Counter

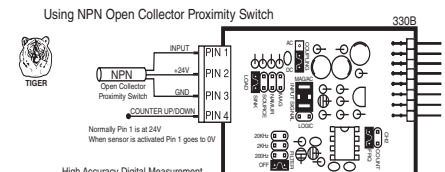

TTL Input Connected to IF10

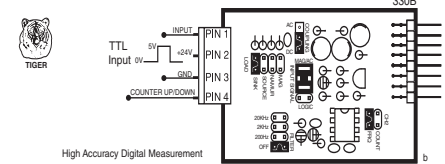

Tach Generator Connected to IF10

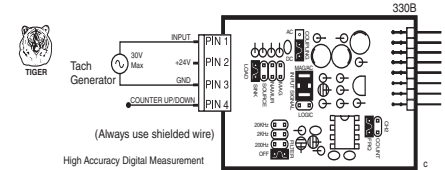

I-Series Input Signal Conditioning Modules continued

NAMUR Sensor Connected to IF10

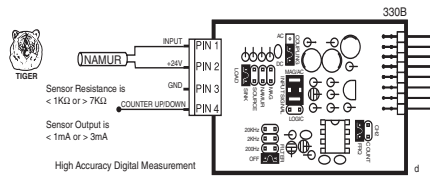

PNP Open Collector Proximity Switch Connected to IF10

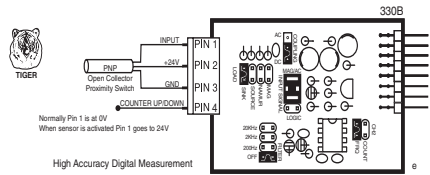

Switch or Dry Contact Connected to IF10

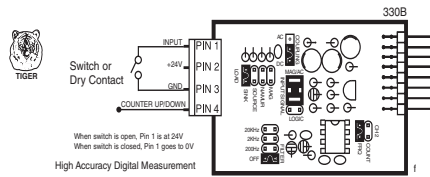

Magnetic Pickup Connected to IF10

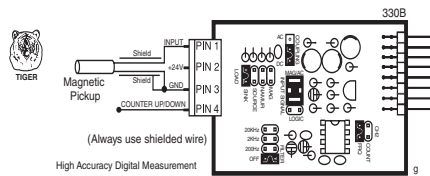

IGYX: Direct Pressure (Absolute or Differential/Gage) with 2 Digital Inputs. See below for ordering code options

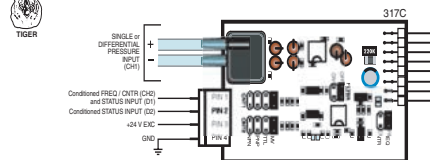

IGYY: Dual Direct Pressure (Absolute or Differential/Gage) see below for ordering code options

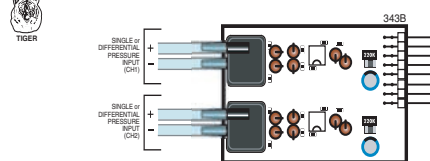

IGYZ: Universal Direct Pressure (Absolute or Differential/Gage) See below for ordering code options

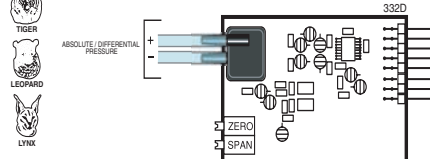

Direct Pressure (IGYX, IGYY & IGYZ) Ordering Code Options

Sensor Range	CH1 Order Code	CH2 Order Code
1 psi Absolute	A	A
1 psi Differential	B	B
5 psi Absolute	C	C
5 psi Differential	D	D
15 psi Absolute	E	E
15 psi Differential	F	F
30 psi Absolute	G	G
30 psi Differential	H	H
100 psi Absolute	J	J
100 psi Differential	K	K

For Single Channel IGYX with two digital inputs, the last digit of order code is always X.
For Universal Direct Pressure IGYZ, the last digit of order code is always Z.

IHO1: pH IHO2: pH with Automatic Temperature Compensation

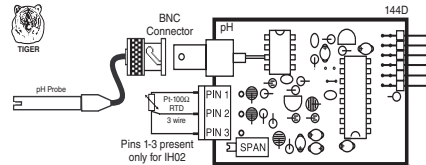

IOR1: ORP (Oxidation Reduction Potential)

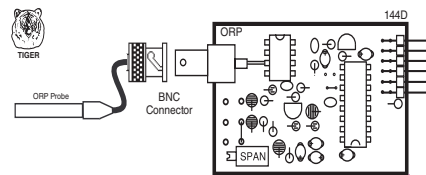

IPO1: Process Loop, 4-20mA IPO2: Process Loop, 4-20mA with 24VDC Exc

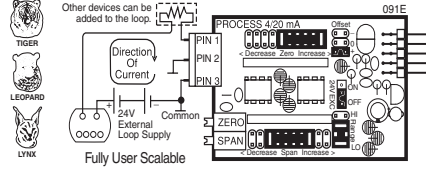

IPO3: Process Input, 1-5V DC with Offset, 24V Exc

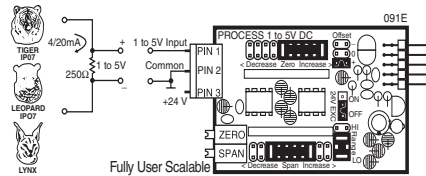

IPO6: Process Loop, 4-20mA w/24VDC Exc and Autocal

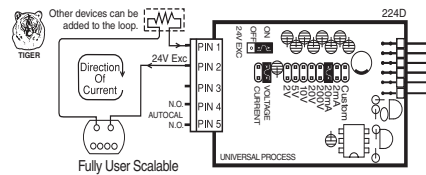

IPO7: Universal Process Input

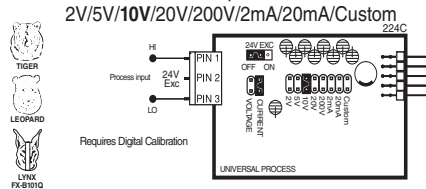

IPO8: Universal Process Input with Autocal

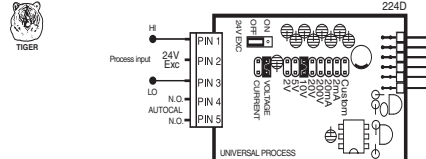

IPO9: 4-20mA with External LIN Table Select

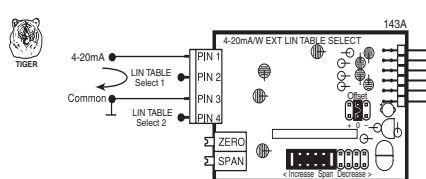

IP10: Process + 3 Digital Inputs

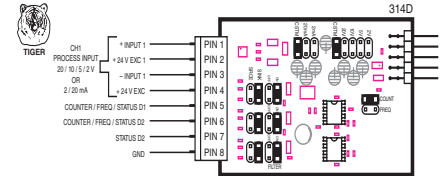

IPT1: Prototype Board for Custom Design

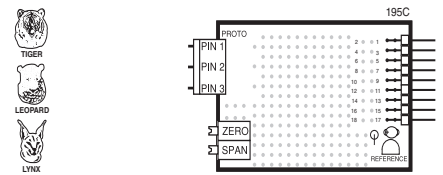

IQD1: Quad DC Volts, 2V DC IQD2: Quad DC mV, 50mV DC

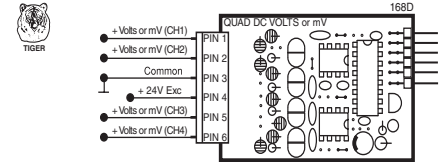

IQP1: Quad 4 to 20mA

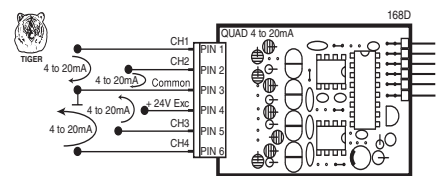

IQT2: Quad RTD Platinum 100Ω RTD 2 Wire Connection

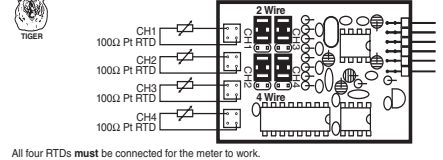

All four RTDs must be connected for the meter to work.

IQT4: Quad RTD Platinum 100Ω RTD 4 Wire Connection

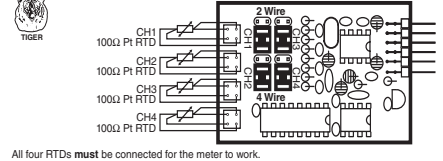

All four RTDs must be connected for the meter to work.

IQT5: Quad RTD / V / V / FREQ

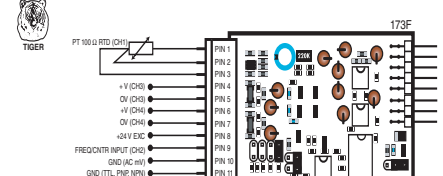

IRO1: Resistance, 2/3/4-Wire, 200Ω/2KΩ/20KΩ

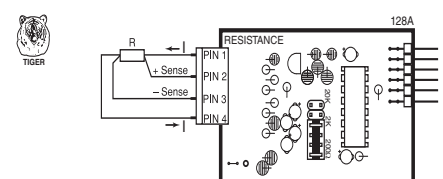

I-Series Input Signal Conditioning Modules continued

IR03: Linear Potentiometer 1KΩ min

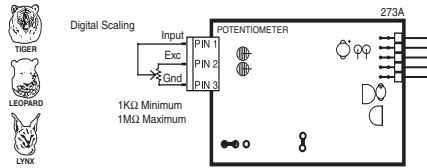

IS01: Strain Gage 5/10VDC Exc., 20/2mV/V, 4/6-wire

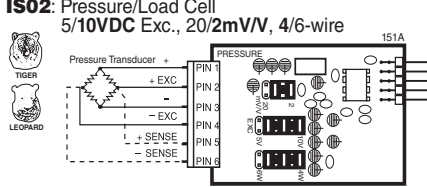

IS03: Pressure/Load Cell with AutoCal 5/10VDC Exc., 20/2mV/V, 4-wire

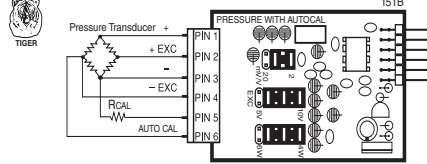

IS04: Pressure/Load Cell Ext Exc., 20/2mV/V, 4/6-wire

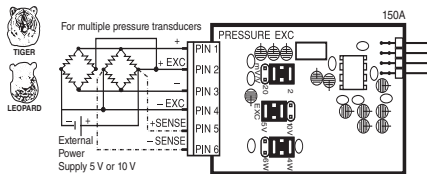

IS05: Pressure/Load Cell 20/2mV/V, 5/10V Exc 4-wire

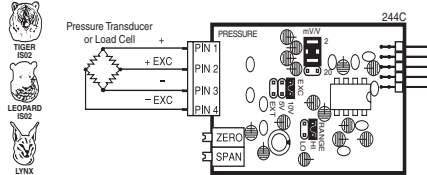

IS06: Pressure/Load Cell Ext Exc., 20/2mV/V, 4-wire

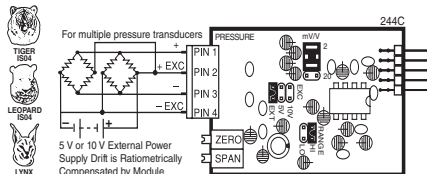

IS07: Pressure/Load Cell Ext Exc. High Impedance, 20/2mV/V, 4/6-wire

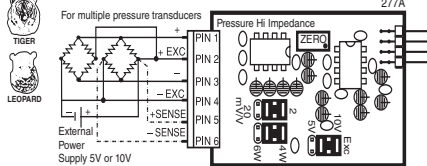

ISD1: Smart DC Volts. 16 bit. Optimized for 50 Hz rejection.
ISD2: Smart DC Volts. 16 bit. Optimized for 60 Hz rejection.
ISD3: Smart DC Volts. 16 bit. 50 Hz rejection w/dual SSRs.
ISD4: Smart DC Volts. 16 bit. 60 Hz rejection w/dual SSRs.

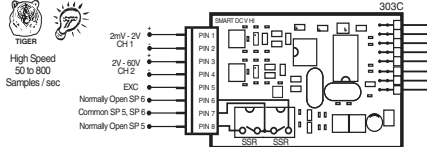

ISD5: Smart DC Volts. 24 Bit. 50 Hz rejection.
ISD6: Smart DC Volts. 24 Bit. 60 Hz rejection.
ISD7: Smart DC Volts. 24 Bit. 50 Hz w/dual SSRs.
ISD8: Smart DC Volts. 24 Bit. 60 Hz w/dual SSRs.

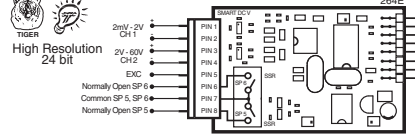

ISD9: Smart Voltage and Resistance Input

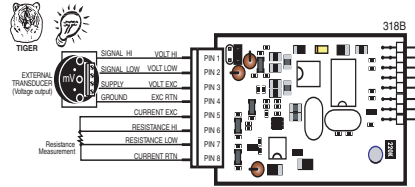

ISDA: Smart Dual DC Volts. 16 bit. 50 Hz rejection.
ISDB: Smart Dual DC Volts. 16 bit. 60 Hz rejection.

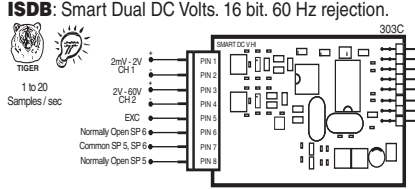

ISL1: Smart Dual LVDT. 50 Hz
ISL2: Smart Dual LVDT. 60 Hz

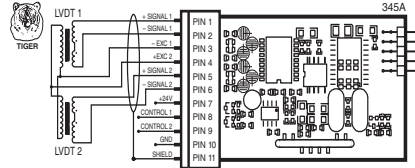

ISM1: Smart Magnetostrictive Input

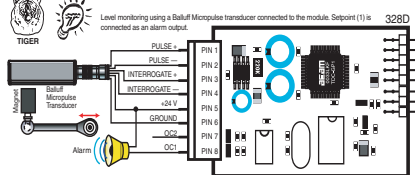

ISP1: Smart Triple Input, Pressure Direct and Dual Counter (Frequency/Counter)

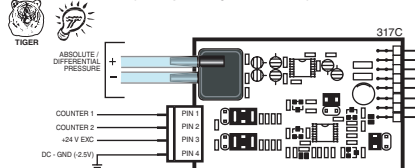

ISR1: Smart Single 3-Wire Potentiometer. 24 bit. 50 Hz
ISR2: Smart Single 3-Wire Potentiometer. 24 bit. 60 Hz

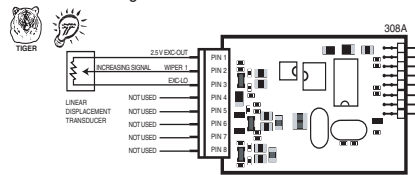

ISR3: Smart Dual 3-Wire Potentiometer. 16 bit. 50 Hz
ISR4: Smart Dual 3-Wire Potentiometer. 16 bit. 60 Hz

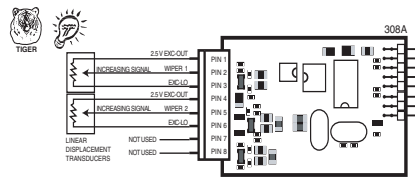

ISS1: Smart Pressure/Load Cell. 16 bit (50 Hz rejection)
ISS2: Smart Pressure/Load Cell. 16 bit (60 Hz rejection)
ISS3: Smart Pressure/Load Cell. 24 bit (50 Hz rejection)
ISS4: Smart Pressure/Load Cell. 24 bit (60 Hz rejection)

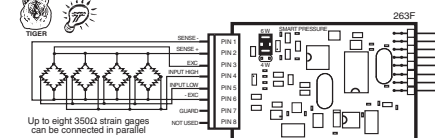

ISS5: Dual Smart Pressure. 16 bit. Optimized for 50 Hz rejection.
ISS6: Dual Smart Pressure. 16 bit. Optimized for 60 Hz rejection.

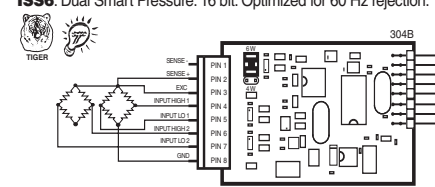

ISS7: Smart Quad Pressure/Load Cell. 16 bit. 50 Hz
ISS8: Smart Quad Pressure/Load Cell. 16 bit. 60 Hz

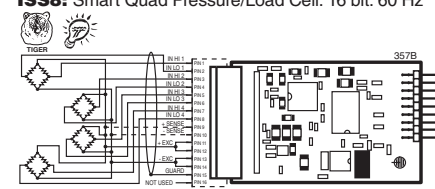

ISS9: Smart Dual Input, LC and Process (4-20mA)

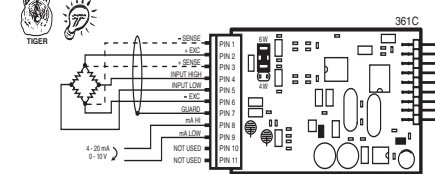

ISSA: Smart Quad Potentiometer/Resistance

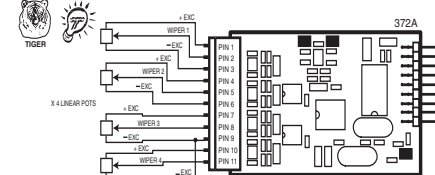

ISSB: Smart Dual Input, Load Cell and RTD

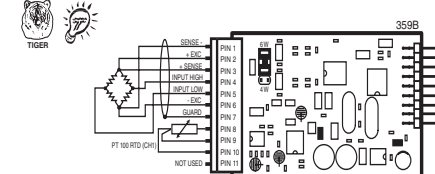

ISSC: Smart Triple Input, 16 bit, Load Cell and two Digital Inputs (Frequency/Counter) (Optimized for 50 Hz)
ISSD: Smart Triple Input, 16 bit, Load Cell and two Digital Inputs (Frequency/Counter) (Optimized for 60 Hz)

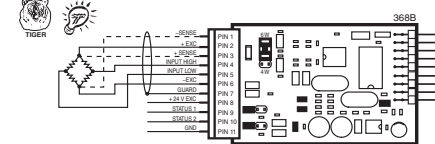

ISSE: Smart Dual Photo Diode Input

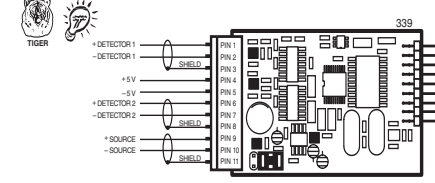

I-Series Input Signal Conditioning Modules continued

IST1: Smart 6 Inputs- 3 RTDs, 2 Proc. & 1 Dig. Input. 50 Hz
IST2: Smart 6 Inputs- 3 RTDs, 2 Proc. & 1 Dig. Input. 60 Hz

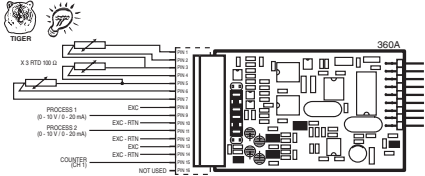

IST3: Smart Quad Thermocouple. 50 Hz
IST4: Smart Quad Thermocouple. 60 Hz

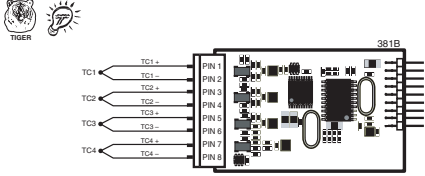

IST5: Smart Dual RTD with 0.01° Res. 50 Hz
IST6: Smart Dual RTD with 0.01° Res. 60 Hz

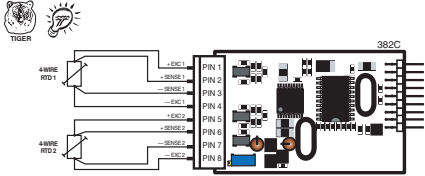

IT01: Thermocouple (J/K/R/S/T/B/N)

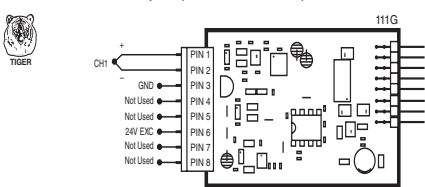

IT02: RTD, 100Ω Pt. 2/3/4-wire
IT12: RTD, 120Ω Nickel 2/3/4-wire
IT13: RTD, 10Ω Copper 2/3/4-wire

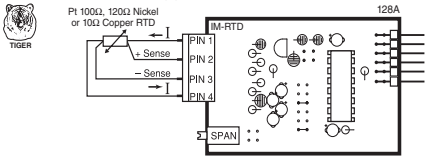

IT03: RTD, 100Ω Pt. 2/3/4-wire (-200 to 800°C)
IT04: RTD, 100Ω Pt. 2/3/4-wire (-200 to 1470°F)
IT05: RTD, 100Ω Pt. 2/3/4-wire (-199.9 to 199.9°F)
IT14: RTD, 100Ω Pt. 2/3/4-wire (-199.9 to 199.9°C)

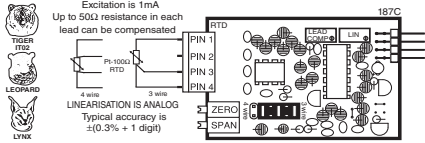

ITD1: Triple DC Volts, 2V DC
ITD2: Triple DC mV, 50mV DC

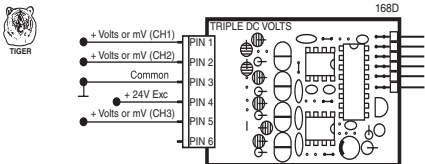

ITP1: Triple 4 to 20mA

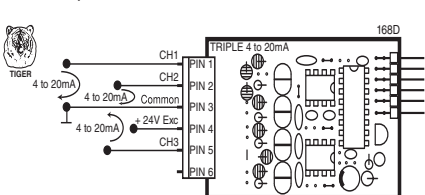

ITT1: Triple Thermocouple (J/K/R/S/T/B/N)

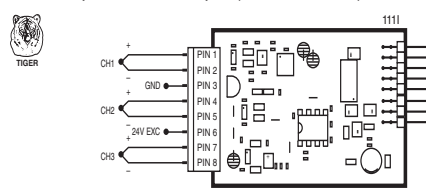

ITT2: Triple RTD Platinum 100Ω RTD
 2 Wire Connection

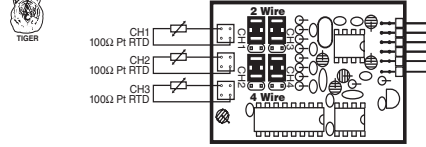

All three RTDs **must** be connected for the meter to work.

ITT3: Triple Input- T/C, T/C (J/K/R/S/T/B/N)
 and 2VDC Input
ITT5: Triple Input- T/C, T/C (J/K/R/S/T/B/N)
 and 50mV DC

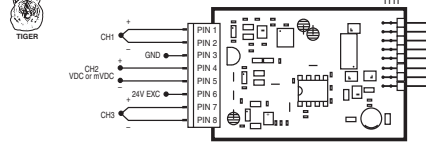

ITT4: Triple Input- T/C, T/C (J/K/R/S/T/B/N)
 and 4 to 20mA

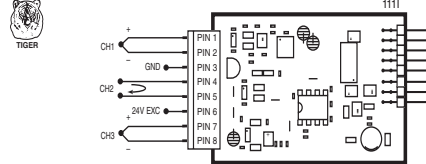

ITT6: Triple Input- T/C (J/K/R/S/T/B/N),
 50mV DC and 50mV DC
ITT7: Triple Input- T/C (J/K/R/S/T/B/N),
 2VDC and 2VDC

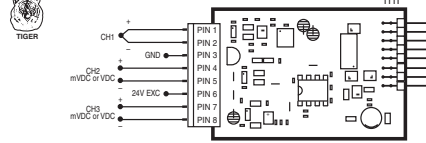

ITT8: Triple Input- T/C (J/K/R/S/T/B/N),
 4 to 20mA and 4 to 20mA

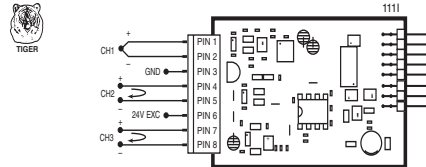

ITT9: Triple Input- T/C (J/K/R/S/T/B/N),
 DCV and 50mV DC

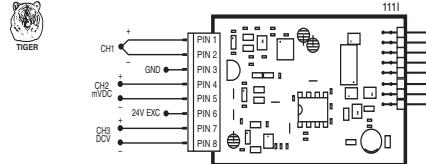

ITTA: Triple Input- T/C (J/K/R/S/T/B/N),
 4 to 20mA and 50mV DC
ITTB: Triple Input- T/C (J/K/R/S/T/B/N),
 4 to 20mA and 2VDC

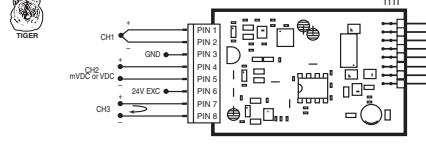

ITTC: Triple RTD Platinum 100Ω RTD
 4 Wire Connection

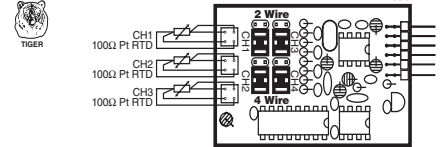

All three RTDs **must** be connected for the meter to work.

ITTE: Triple Input- RTD / RTD / FREQ

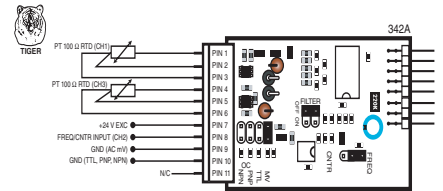

ITTF: Triple Input - Thermocouple / 4-20mA / Frequency
ITTG: Triple Input - Thermocouple / V / Frequency

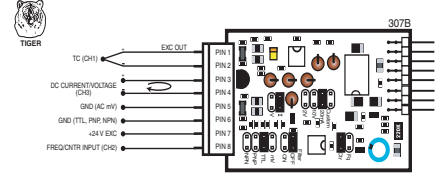

IWO1: Single Phase Power, 300V/1A
IWO2: Single Phase Power, 300V/5A
IWO4: Single Phase Power, 600V/1A
IWO5: Single Phase Power, 600V/5A

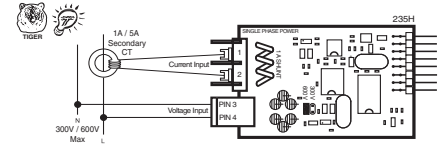

IWO3: DC-Watts, 10V/50mV DC

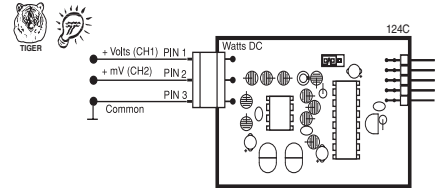

INPUT MODULE COMPONENT GLOSSARY

Dual input modules, and those modules exclusively compatible with the Leopard or Tiger Families, do not have zero and span adjustments. These modules are scaled and calibrated using the internal software functions of each individual meter.

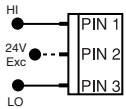

Input and Output Pins

On most modules Pin 1 is the Signal High input and Pin 3 is the Signal Low input. Typically Pin 2 is used for Excitation Voltage output.

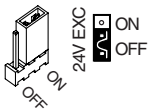

24 V DC Output for 4-20 mA Header

On some modules this header enables a 24 V DC 25 mA (max) Excitation/Auxiliary output to be connected to Pin 2 that can power most 4-20 mA transmitters.

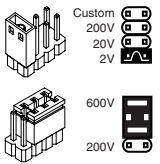

INPUT RANGE Headers

Range values are marked on the PCB. Typically two to eight positions are provided, which are selected with either a single or multiple jumper clip. When provided, a custom range position is only functional when the option has been factory installed.

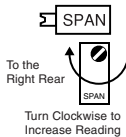

SPAN Potentiometer (Pot)

If provided, the 15 turn SPAN pot is always on the right side (as viewed from the rear of the meter). Typical adjustment is 20% of the input signal range.

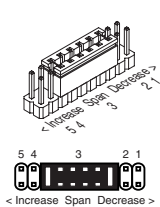

SPAN ADJUST Header

This unique five-position header expands the adjustment range of the SPAN pot into five equal 20% steps, across 100% of the input Signal Span. Any input Signal Span can then be precisely scaled down to provide any required Display span from full scale to the smallest viewable unit.

SPAN Adjust Header position	1	2	3	4	5
SPAN Pot %	20%	20%	20%	20%	20%
Signal Span %	20%	40%	60%	80%	100%

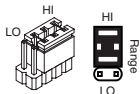
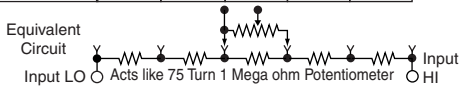

SPAN RANGE Header

When this header is provided it works in conjunction with the SPAN ADJUST Header by splitting its adjustment range into a Hi and a Lo range. This has the effect of dividing the adjustment range of the SPAN pot into ten equal 10% steps across 100% of the input Signal Span.

SPAN Adjust Header position	Span Adjust Header					Span Range Header				
	1	2	3	4	5	1	2	3	4	5
SPAN Pot %	10%	10%	10%	10%	10%	10%	10%	10%	10%	10%
Signal Span %	10%	20%	30%	40%	50%	60%	70%	80%	90%	100%

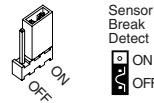
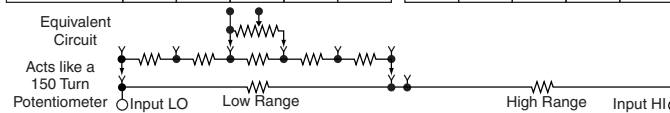

Function Select Headers

On some modules various functions such as Amps and Volts, 4 wire and 6 wire, or cold junction compensation are selected by header positions that are marked on the PCB.

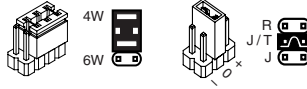

Excitation Output Select Headers

When excitation outputs are provided, they are typically 5 V DC max 30 mA, 10 V DC max 30 mA (300Ω or higher resistance) or external supply. They are selected by either a single or multiple jumper clip.

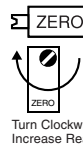
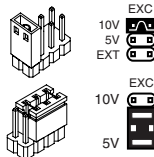

ZERO Potentiometer (Pot)

If provided, the ZERO pot is always to the left of the SPAN pot (as viewed from the rear of the meter). Typically it enables the input signal to be offset ±5% of the full scale display span.

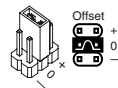
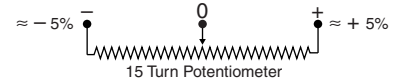

ZERO OFFSET RANGE Header

When provided, this three position header increases the ZERO pot's capability to offset the input signal, by ±25% of the full scale display span. For example a Negative offset enables a 1 to 5 V input to display 0 to full scale. The user can select negative offset, positive offset, or no offset (ZERO pot disabled for two step non-interactive span and offset calibration).

NEGATIVE OFFSET Decreases Digital Reading		POSITIVE OFFSET Increases Digital Reading	
ZERO Pot%	- 100% of Offset	- 0 +	+ 100% of Offset
Offset Range	≈ - 25%	No Offset Zero Pot Disabled	≈ + 25%

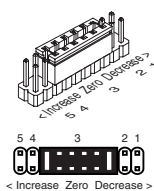

ZERO ADJUST Header

When this header is provided, it works in conjunction with the ZERO OFFSET RANGE Header, and expands the ZERO pot's offset capability into five equal negative steps or five equal positive steps. This enables virtually any degree of input signal offset required to display any desired engineering unit of measure.

ZERO Adjust Header Position	Zero Adjust Header NEGATIVE OFFSET					Zero Adjust Header POSITIVE OFFSET				
	5	4	3	2	1	1	2	3	4	5
ZERO Pot Span	6400	6400	6400	6400	6400	6400	6400	6400	6400	6400
Offset Range	-25200 to -31600	-18900 to -25300	-12600 to -19000	-6300 to -12700	0 to -6400	0 to +6400	+6300 to +12700	+12600 to +19000	+18900 to +25300	+25200 to +31600

CALIBRATE position, Zero Pot disengaged (no offset applied)

Ordering Information

Prices subject to change without notice.

BASIC MODEL #	DISPLAY	POWER SUPPLY	INPUT MODULE	ANALOG OUTPUT*	SERIAL OUTPUT*	RELAY OUTPUT*	OPTIONS / ACCESSORIES
GI-50E							OA

Add to the basic model number the order code suffix for each standard option required. The last suffix is to indicate how many different special options and/or accessories that you may require to be included with this product. *Except when the DeviceNet™ serial output option is selected, a meter ordered with any of these outputs requires an Output Module Carrier Board which should be automatically included with the order, with an additional charge of \$7. (See special Options and Accessories section)

Ordering Example: GI-50E-DR-PS1-IA01-AIC-OR12-0A2 plus SA-GI/OM-CB, \$395 + N/C + N/C + 35 + 50 + 60 + 7 = \$547

► BASIC MODEL NUMBER

GI-50E	144x72mm, 5 Digit, E Version	\$395
GI-50T	144x72mm, 5 Digit, T Version	\$495

Standard Options for this Model Number

Order Code Suffix Description List

► DISPLAY

DR	Red LED	\$0
DG	Green LED	\$10
DB	Super-bright Red LED	\$25

► POWER SUPPLY

PS1	.85-265VAC/95-370VDC	\$0
PS2	.15-48VAC/10-72VDC	\$35

► INPUT MODULES (Partial List. See www.texmate.com)

Unless otherwise specified Texmate will ship all modules precalibrated with factory preselected ranges and/or scalings as shown in **BOLD** type.

IA01	AC-Volts Scaled RMS, 200/600V AC	\$35
IA02	AC-Volts Scaled RMS, 200mV/2V/20V AC	\$35
IA03	AC-mA Scaled RMS, 2/20/200mA AC	\$40
IA04	AC-Amps Scaled RMS, 0-1 Amp AC (0-100.00)	\$40
IA05	AC-Amps Scaled RMS, 0-5 Amp AC (0-100.00)	\$40
IA06	AC-Volts True RMS, 200/600V AC	\$55
IA07	AC-Volts True RMS, 200mV/2V/20V AC	\$55
IA08	AC-mA True RMS, 2/20/200mA AC	\$55
IA09	AC-Amps True RMS, 0-1 Amp AC (0-100.00)	\$55
IA10	AC-Millivolt, Scaled RMS, 100mV AC	\$55
IA11	AC-Amps True RMS, 0-5 Amp AC (0-100.00)	\$55
IA12	AC-Millivolt, True RMS, 100mV AC	\$55
IC02	Quadrature Counter	\$65
IC03	Quadrature Counter with Dual SSRs	\$105
ID01	DC-Volts, 2/20/200V/Custom w/24V DC Exc	\$25
ID02	DC-Millivolt, 20/50/ 100/200mV DC w/24V DC Exc	\$35
ID03	DC-Milliamp, 2/20/200mA DC w/24V DC Exc	\$25
ID04	DC-Amps, 5A DC	\$50
ID05	DC-Volts 2/20/200/Custom V DC w/Offset and 24V Exc.	\$45
ID06	DC-Volts 2/20/200/Custom V DC w/Ext.Decimal Select	\$40
ID07	DC-Milliamp, 2/20/200mA DC w/Offset and 24V Exc	\$35
ID08	DC-Volts, 2/20/200/Custom V DC w/Ext.LIN Table Select	\$40
ID09	DC-Amps, 1A DC	\$50
IDC1	Dual Input, Counter	\$75
IDD1	Dual Input, Volts DC/Volts DC, 2V DC	\$65
IDD2	Dual Input DC-Millivolts, 50mV DC(100.00)	\$65
IDD3	Dual Input DC-Milliamperes, 2mA DC	\$65
IDD4	Dual Input, Volts/millivolts 2V/50mV DC(100.00)	\$65
IDD5	Dual Input DC Volts and 4-20 mA	\$65
IDD6	Dual Input DC mV and 4-20 mA	\$65
IDF2	Dual Frequency	\$85
IDP1	Dual Process Loop Input, 4-20mA (0-100.00)	\$65
IDP2	Dual Input, 3-wire RTD / 4-20mA (0-100.00)	\$65
IDP3	Dual Input, K/R/S/T/J Thermocouple / 4-20mA(0-100.00)	\$65
IDR1	Dual Resistance Input, 0.2/2/20KΩ	\$65
IDS1	Dual Strain Gage Input, 4 wire 2mV/V	\$125
IDS2	Dual Pressure Input, 4 wire 2mV/V	\$125
IDS3	Dual Input, Strain Gage and Frequency	\$95
IDT1	Dual Thermocouple Input J/K/R/T	\$75
IDT2	Dual RTD Input, 2- and 3-wire, 100Ω Pt	\$65
IDT3	Dual Input, 3-wire RTD / Volts 2V DC	\$65
IDT4	Dual Input, Thermocouple / Volts 2V DC	\$65
IDT5	Dual Input, K/R/S/T/J Thermocouple / DC-Millivolts, 50mV DC	\$65
IDT6	Dual Input, Thermocouple and Load Cell	\$95
IF06	Line Frequency, 50-500VAC	\$55
IF10	Universal Frequency / RPM / UP DOWN Counter	\$55
IGYX*	Direct Pressure (Abs. or Differential/Gage) with 2 Digital Inputs	\$125
IGYY*	Dual Direct Pressure (Absolute or Differential/Gage)	\$175
IGYZ*	Universal Direct Pressure	\$100
IH01	pH Indication w/ Manual Temperature Compensation	\$75
IH02	pH Indication w/ Automatic Temperature Compensation	\$95
IOR1	Oxidation Reduction Potential (ORP)	\$75
IP01	Process Loop, 4-20mA (0-100.00)	\$35
IP02	Process Loop, 4-20mA(0-100.00) w/24VDC Exc	\$45
IP03	Process Input, 1-5V DC(0-100.00) w/Offset, 24V Exc	\$45
IP06	Process Loop, 4-20mA(0-100.00) w/24VDC Exc and Autocal	\$45
IP07	Universal Process 2V/5V/ 10V/20V/200V/2mA/20mA/Custom	\$30
IP08	Universal Process 2V/5V/ 10V/20V/200V/2mA/20mA/Custom w/Autocal	\$55
IP09	Process Loop, 4-20mA (0-100.00) w/ External Lin Table select	\$40

IP10	Process + 3 Digital Inputs	\$75
IP11	Prototype Board for Custom Design	\$15
IQD1	Quad DC Volts, 2V DC	\$125
IQD2	Quad DC-Millivolts, 50mV DC(100.00)	\$125
IQP1	Quad Process Loop, 4-20mA (0-100.00)	\$125
IQT2	Quad RTD Input, 2-Wire, 100Ω Pt	\$125
IQT4	Quad RTD Input, 4-wire, 100Ω Pt	\$125
IQT5	Quad - Thermocouple / V / V / Frequency	\$125
IR01	Resistance, 2-, 3- , or 4-Wire, 200Ω/ 2KΩ/20KΩ	\$35
IR02	3-Wire Potentiometer 1KΩ min (0-F.S.)	\$40
IR03	Linear Potentiometer, 3-wire, 1KΩ min	\$40
ISD1*	Smart DC Volts, High Speed 16 bit, 1, 10, 50, 200, 400, 800 Hz update rates	\$65
ISD2**	Smart DC Volts, High Speed 16 bit, 1, 10, 60, 240, 480, 960 Hz update rates	\$65
ISD3*	Smart DC Volts, High Speed 16 bit, 1Hz to 800Hz w/dual isolated SSRs	\$105
ISD4**	Smart DC Volts, High Speed 16 bit, 1Hz to 960Hz w/dual isolated SSRs	\$105
ISD5*	Smart DC Volts, Hi Resolution & Accuracy 24 bit (1 million counts) 1-400Hz	\$175
ISD6**	Smart DC Volts, Hi Resolution & Accuracy 24 bit (1 million counts) 1-480Hz	\$175
ISD7*	Smart DC Volts, Hi Resolution & Accuracy 24 bit 1-400Hz w/dual isolated SSRs	\$215
ISD8**	Smart DC Volts, Hi Resolution & Accuracy 24 bit 1-480Hz w/dual isolated SSRs	\$215
ISD9	Smart Voltage Resistance	\$125
ISDA*	Smart Dual Input DC Volts, 16 bit, 1Hz to 20Hz update (50 Hz rejection)	\$100
ISDB**	Smart Dual Input DC Volts, 16 bit, 1Hz to 20Hz update (60 Hz rejection)	\$100
ISL1*	Smart Dual LVDT (50 Hz rejection)	\$195
ISL2**	Smart Dual LVDT (60 Hz rejection)	\$195
ISM1	Smart Magnetostrictive	\$125
IS01	Strain Gage 5/10VDC Exc., 20/2mV/V, 4/6-wire	\$55
IS02	Pressure 5/10VDC Exc., 20/2mV/V, 4- or 6-wire	\$55
IS03	Pressure 5/10VDC Exc., 20/2mV/V, 4/6-wire w/Autocal	\$65
IS04	Pressure Ext Exc., 20/2mV/V, 4- or 6-wire	\$45
IS05	Pressure/Load Cell 20/2mV/V, 5/10V Exc 4-wire	\$55
IS06	Pressure/Load Cell Ext Exc., 20/2mV/V, 4-wire	\$55
IS07	Pressure 20/2mV/V with High Impedance and External Excitation	\$65
IS01	Smart Triple Input, Pressure Direct and Dual Counter (Frequency/Counter)	\$150
ISR1*	Smart Single 3-wire Potentiometer (50 Hz)	\$105
ISR2**	Smart Single 3-wire Potentiometer (60 Hz)	\$105
ISR3*	Smart Dual 3-wire Potentiometer (50 Hz)	\$125
ISR4**	Smart Dual 3-wire Potentiometer (60 Hz)	\$125
ISS1*	Smart Pressure/Load Cell. Standard Resolution 16 bit (50 Hz rejection)	\$75
ISS2**	Smart Pressure/Load Cell. Standard Resolution 16 bit (60 Hz rejection)	\$75
ISS3*	Smart Pressure/Load Cell. Hi Res & Accuracy 24 bit (50 Hz rejection)	\$150
ISS4**	Smart Pressure/Load Cell. Hi Res & Accuracy 24 bit (60 Hz rejection)	\$150
ISS5*	Dual Smart Pressure/Load Cell. Standard Resolution 16 bit (50 Hz rejection)	\$125
ISS6**	Dual Smart Pressure/Load Cell. Standard Resolution 16 bit (60 Hz rejection)	\$125
ISS7*	Smart Quad Pressure/Load Cell (50 Hz)	\$150
ISS8**	Smart Quad Pressure/Load Cell (60 Hz)	\$150
ISS9	Smart Dual Input, Load Cell and Process (4-20mA)	\$95
ISSA	Smart Quad Potentiometer/Resistance	\$150
ISSB	Smart Dual Input, Load Cell and RTD	\$95
ISSC*	Smart Triple Input, Load Cell and two Digital Inputs (Frequency/Counter)	\$125
ISSD**	Smart Triple Input, Load Cell and two Digital Inputs (Frequency/Counter)	\$125
ISSE	Smart Dual Photo Diode Input	\$125
IST1*	Smart Six Inputs, 3 Pt 100 RTD, 2 Process and 1 Digital Input (50 Hz)	\$150
IST2**	Smart Six Inputs, 3 Pt 100 RTD, 2 Process and 1 Digital Input (60 Hz)	\$150
IST3*	Smart Quad Thermocouple (50 Hz)	\$150
IST4**	Smart Quad Thermocouple (60 Hz)	\$150
IST5*	Smart Dual RTD (50 Hz)	\$125
IST6**	Smart Dual RTD (60 Hz)	\$125
IT01	Thermocouple Input, J/K/R/S/T/B/N	\$30
IT02	RTD, 100Ω Pt. 2-, 3- , or 4-wire	\$35
IT03	RTD, 100Ω Pt. 2/3/4-wire (-200 to 800°C)	\$40
IT04	RTD, 100Ω Pt. 2/3/4-wire (-200 to 1470°F)	\$40
IT05	RTD, 100Ω Pt. 2/3/4-wire (-199.9 to 199.9°F)	\$40
IT12	RTD, 120Ω Nickel 2/3/4-wire	\$35
IT13	RTD, 10Ω Copper 2/3/4-wire	\$35
IT14	RTD, 100Ω Pt. 2/3/4-wire (-199.9 to 199.9°C)	\$40
ITD1	Triple DC Volts, 2V DC	\$95
ITD2	Triple DC-Millivolts, 50mV DC(100.00)	\$95
ITP1	Triple Process Loop, 4-20mA (0-100.00)	\$95
ITT1	Triple Thermocouple	\$95
ITT2	Triple RTD Input, 2-wire, 100Ω Pt	\$95
ITT3	Triple Input, Dual Thermocouple J/K/R/S/T/B/N and DCV 2V	\$95
ITT4	Triple Input. Dual Thermocouple J/K/R/S/T/B/N and 4 to 20mA	\$95
ITT5	Triple Input. Dual Thermocouple J/K/R/S/T/B/N and DC MV	\$95
ITT6	Triple Input. Thermocouple J/K/R/S/T/B/N and Dual DC MV	\$95
ITT7	Triple Input. Thermocouple J/K/R/S/T/B/N and Dual DC Volts	\$95
ITT8	Triple Input. Thermocouple J/K/R/S/T/B/N and Dual 4-20mA	\$95
ITT9	Triple Input. Thermocouple J/K/R/S/T/B/N and DC Volt and DC MV	\$95
ITTA	Triple Input. Thermocouple J/K/R/S/T/B/N and 4-20mA and DC MV	\$95
ITTB	Triple Input. Thermocouple J/K/R/S/T/B/N and 4-20mA and DC Volt	\$95
ITTC	Triple RTD Input, 4-Wire, 100Ω Pt	\$95
ITTE	Triple - RTD / RTD / Frequency	\$125

Ordering Information continued

ITTF	Triple Input, Thermocouple / 4-20mA / Frequency	\$.95
ITTG	Triple Input, Thermocouple / V / Frequency	\$.95
IW01	Single Phase Power (Watts, V, A, Hz, PF, Whr) 300V/1A , 600V/1A	\$.75
IW02	Single Phase Power (Watts, V, A, Hz, PF, Whr) 300V/5A , 600V/5A	\$.75
IW03	DC-Watts, 200V DC/50mV DC from Shunt (0-100.00)	\$.75
IW04	Single Phase Power, 600V/1A	\$.75
IW05	Single Phase Power, 600V/5A	\$.75

*Optimized for 50 Hz rejection. **Optimized for 60 Hz rejection.

► ANALOG OUTPUT *Add \$7 for an Output Module Carrier Board

AIC	Isolated 16 Bit Current Output, 4-20mA	\$.50
AIV	Isolated 16 Bit Voltage Output, 0-10VDC	\$.50
ADV	Isolated 16 Bit Voltage Output, Dual 0-10VDC	Call

► SERIAL OUTPUT *Add \$7 for Output Module Carrier Board, unless one is already ordered.

S2	Isolated ASCII Code RS-232 (Requires Cable, See Accessories)	\$.65
S4	Isolated ASCII Code RS-485 (Requires Cables, See Accessories)	\$.75
S5	Isolated ModBus Protocol RS232	\$.85
S6	Isolated ModBus Protocol RS485	\$.95

► RELAY OUTPUT for FI and GI MAIN BOARDS

The GI meter supports up to six setpoints. Relay outputs for one to four setpoints can be ordered for factory installation on the main board in any required combination of up to two 10A form C and two 5A form A relays. The GI accepts Relay Output Modules that plug into the GI Output Module Carrier Board, however, setpoints 1, 2, 3 & 4 are common with any relays mounted on the main board.

R1	Single 5A Form A Relay	\$.30
R2	Dual 5A Form A Relays	\$.55
R11	Single 10A Form C Relay	\$.35
R12	Dual 10A Form C Relays	\$.65
R13	Dual 10A Form C & One 5A Form A Relays	\$.90
R14	Dual 10A Form C & Dual 5A Form A Relays	\$.110
R15	Single 10A Form C & Dual 5A Form A Relays	\$.80
R16	Single 10A Form C & Single 5A Form A Relays	\$.60

► **RELAY OUTPUT & LOGIC I/O MODULES** *If a meter is ordered with a Relay Output Module, but without Analog or Serial Output, an Output Module Carrier Board for \$7 should be automatically added to the order.

Relay Output Modules

OR11	One 10 Amp Form C Relay, Isolated	\$.30
OR15	One 10 Amp Form C and Two 5 Amps Form A Relays	\$.75
OR16	One 10 Amp Form C and One 5 Amp Form A Relays	\$.55
OR12	Two 10 Amp Form C Relays, Isolated	\$.60
OR14	Two 10 Amp Form C and Two 5 Amps Form A Relays	\$.105
OR23	Two 10 Amp Form C and One 5 Amp Form A Relay, Isolated	\$.85
OR25	One 10 Amp Form C and Two 5 Amps Form A Relays, Isolated	\$.75
OR31	One 5 Amp Form A Relay, Isolated	\$.25
OR32	Two 5 Amp Form A Relays, Isolated	\$.50
OR33	Three 5 Amp Form A Relays, Isolated	\$.70
OR34	Four 5 Amp Form A Relays, Isolated	\$.90
OR45	Five 5 Amp Form A Relays, common in groups of three	\$.110
OR46	Six 5 Amp Form A Relays, common in groups of three	\$.130

Solid State Relay (SSR) Output Modules DC Only

OR51	One 400V DC Solid State Relay (SSR) 210mA	\$.25
OR52	Two 400V DC Solid State Relays (SSR) 210mA	\$.50
OR53	Three 400V DC Solid State Relays (SSR) 210mA	\$.70
OR54	Four 400V DC Solid State Relays (SSR) 210mA	\$.90

Solid State Relay (SSR) Output Modules AC/DC

OR61	One 400V AC/DC Solid State Relay (SSR) 140mA	\$.25
OR62	Two 400V AC/DC Solid State Relays (SSR) 140mA	\$.50
OR63	Three 400V AC/DC Solid State Relays (SSR) 140mA	\$.70
OR64	Four 400V AC/DC Solid State Relays (SSR) 140mA	\$.90

Open Collector / TTL / 5V DC Outputs to Drive External SSRs or Logic Input Devices

OR71	Six 5V DC 50mA outputs	\$.35
OR72	Six open collector outputs	\$.35

Opto Isolated I/O Modules for Connecting to External Breakout Box

OR81	Six Outputs & Six Inputs (T Version Only)	\$.120
OR82	Sixteen Outputs & Six Inputs (T Version Only)	\$.175

Data Acquisition Module with Removable Flash Card Memory and Two SSR Outputs

OR91	Module with 4 Meg Memory	\$.150
------	--------------------------	--------



Special Options and Accessories

Part Number	Description	List
-------------	-------------	------

► SPECIAL OPTIONS (Specify Inputs or Outputs & Req. Reading)

Output Module Carrier Boards

*One carrier board must be ordered with any meter that includes any one or more of the following options: Analog Output, Serial Output and/or Relay Output Modules. The exception is when the DeviceNet™ option is ordered, as it includes a special Output Carrier Board that accepts analog output options and relay output modules.

SA-GI/OM-CB	Output Module Carrier Board, GI series	\$.7
-------------	--	------

Memory Upgrade and Real Time Clock Options for GI- Series E Version Meters

OP-G1MB/R-E	1MB EEPROM with Real Time Clock	\$.95
OP-G1MB-E	1MB EEPROM	\$.50

OP-G32K/R-E	32K EEPROM with Real Time Clock	\$.65
OP-G32K-E	32K EEPROM	\$.20
OP-G4K/R-E	4K EEPROM with Real Time Clock	\$.45

Memory Upgrade and Real Time Clock Options for GI- Series T Version Meters

OP-G1MB/R-T	1MB EEPROM with Real Time Clock	\$.95
OP-G1MB-T	1MB EEPROM	\$.50
OP-P32K/R-T	32k EEPROM with Real Time Clock	\$.65

Range Change and Custom Scaling

Customer must specify the input signal range or digital span and the desired display range, or output signal range. Multiple inputs, outputs or multiple displays require a separate range change or custom scaling part number and a specified channel for each input, output or display.

Range Change and calibration to another header selectable standard range.

CR-CHANGE	Range Change from Standard Range shown in BOLD type	\$.7
-----------	--	------

Display Custom Scaling within any header selectable input range of module or a combination of module and the software scaling capability of the meter.

CS-4.5/5/6	Custom display scaling within standard ranges	\$.18
CS-BAR	Custom bargraph display scaling within standard ranges	\$.12

Output Custom Scaling within standard ranges of analog output.

COA-4.5/5/6	Custom scaling of analog output for digital meters & bargraphs	\$.18
-------------	--	-------

Custom Configuration of programmable functions, codes, settings, linearization tables and macro programs.

CCI-SETUP	NRC to set-up custom configuration file and issue serial #	\$.40
CCI-INSTL	Factory installation - custom configuration, specify serial # CCI-	\$.10
CLT-SETUP	NRC to set-up linearization tables (per 32 points)	\$.40
CLT-INSTL	Factory installation - linearization tables, specify serial # CLT-	\$.10
CMP-SETUP	NRC to set-up ordering of a macro programming (does not include programming of macro code)	\$.40
CMP-INSTL	Factory installation - macro program, specify serial # CMP-	\$.40

Custom Selectable Range Installation or Modification

CSR-SETUP	NRC to set-up custom selectable range	\$.30
CSR-INSTL	Factory installation - custom configuration, specify serial # CSR-	\$.10

Custom Special Scaling Beyond the Standard Range

CSS-SETUP	NRC to set-up custom special scaling	\$.30
CSS-56/INSTL	Installation - for 4.5, 5.0 and 6.0 meters, specify serial # CSS-	\$.30
CSS-BR/INSTL	Installation - for Bargraph, specify serial # CSS-	\$.20

Custom Output - Relays Installed in Non-Standard Locations

COR-SETUP	NRC to set-up Relays in non-standard locations	\$.15
COR-INSTL	Installation - Relays in non-standard locations, specify serial # COR-	\$.10

Configuration Utility Software and Tiger 320 Macro-Language Compiler and Development Software. CD and Manuals. (Free downloads and updates on the web)

OP-SW/IPRG	Configuration Utility Software for Tiger 320	\$.10
OP-SW/CMPLR	Macro-language Compiler and development software for Tiger 320	\$.15
OP-SW/COMBO	Configuration Utility and Macro-language Compiler for Tiger 320	\$.20

► ACCESSORIES (Specify Serial # for Custom Artwork Installation)

Cables/Serial Communications

OM-CABLE232
OM-CABLE485



OM-CABLE232	RS232: DB9 female to RJ6 phone plug adapter plus 6 ft RJ6 cable	\$.10
OM-CABLE485	RS485: DB9 female to RJ6 phone plug adapter plus 6 ft RJ6 cable	\$.10

CV-485/232



RS485 to RS232 Bi-directional Converter

CV-485/232	RS485 to RS232 Converter w/ CN-DB9F/25M & CN-DB9M/25F	\$.75
------------	---	-------

USB to RS232 Converter

CV-USB/232	USB to DB9 RS232 Converter	\$.60
------------	----------------------------	-------



CV-MOD/TB10

Ethernet Converters

CV-MOD/TB10	Modbus / Ethernet to Serial Tbase 10 Converter	\$.280
CV-RS/TB10	Serial to Tbase 10 Converter	\$.250
CV-RS/TB100	Serial to Tbase 10 / 100mg Converter	\$.335
OM-RS232ETH	Ethernet Converter for RS232, includes OM-CABLE232 cable	Call
OM-RS485ETH	Ethernet Converter for RS485, includes OM-CABLE485 cable	Call

80-9F/25M-6



CN-DB/9



80-MOD/PLG



80-9F/25M-6	.6 ft Cable, DB9F to DB25M	\$.8
CN-DB/9	RJ6F to DB9F Converter	\$.6

Ordering Information continued

80-MOD/PLG6 ft Cable, 6 Pin to 6 Pin RJ6 Plug	\$4
CN-6P6C/TDual 6 Pin RJ6 Adapter to Daisy Chain RS485	\$5
80-RJ/TERM6 Pin Terminator Plug for RS485	\$2
CN-DB9F/25MDB9F to DB25M Converter	\$6
CN-DB9M/25FDB9M to DB25F Converter	\$6

External Power Supply

PS-240524VDC Regulated Power Supply, 0.5A Output	\$25
PS-5205VDC Regulated Power Supply, 2A Output	\$25

Cases and Case Accessories

GN.CAS144X72144x72mm Complete Case with bezel	\$25
75-GBBZ144X7Black Bezel for 144x72mm Case	\$2
75-DMTCLIPFMounting Slide Clips, extra set	\$2

Metal Surround Case



- Provides extra strength.
- Blocks out electrical noise.
- Protects against the spread of panel fires.



OP-MTL144X72Metal Surround Case, includes screw mounting clips	\$25
OP-MTLCLIPScrew Mounting Clips (2 pc) to screw tighten slide brackets	\$6

Connectors

Input Power Screw Terminal Plug

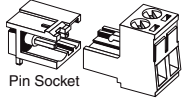

Pin Socket
Part No: 93-PLUG2P-DP

Right-angled Screw Terminal Plug

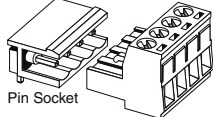

Pin Socket

- Part Numbers:
93-PLUG2P-DR.....2 pins
93-PLUG3P-DR.....3 pins
93-PLUG4P-DR.....4 pins
93-PLUG5P-DR.....5 pins
93-PLUG6P-DR.....6 pins

93-PLUG2P-DPExtra Screw Terminal Conn., 2 Pin Power Plug	\$2
93-PLUG2P-DRExtra Screw Terminal Conn., 2 Pin Plug	\$2
93-PLUG3P-DRExtra Screw Terminal Conn., 3 Pin Plug	\$3
93-PLUG4P-DRExtra Screw Terminal Conn., 4 Pin Plug	\$4
93-PLUG5P-DRExtra Screw Terminal Conn., 5 Pin Plug	\$5
93-PLUG6P-DRExtra Screw Terminal Conn., 6 Pin Plug	\$6

Straight-thru Input Power Screw Terminal Plug

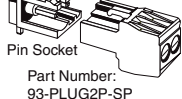

Pin Socket
Part Number:
93-PLUG2P-SP

Straight-thru Screw Terminal Plug

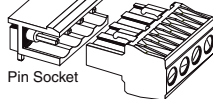

Pin Socket

- Part Numbers:
93-PLUG2P-DS.....2 pins
93-PLUG3P-DS.....3 pins
93-PLUG4P-DS.....4 pins

93-PLUG2P-DSExtra Screw Terminal Conn., straight-thru 2 Pin Plug	\$2
93-PLUG3P-DSExtra Screw Terminal Conn., straight-thru 3 Pin Plug	\$3
93-PLUG4P-DSExtra Screw Terminal Conn., straight-thru 4 Pin Plug	\$4

3.5mm Pitch Screw Terminal Plugs for Smart Modules and DeviceNet

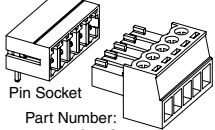

Pin Socket
Part Number:
93-PLUG5PS

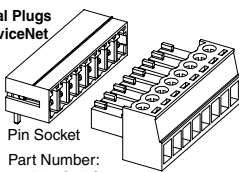

Pin Socket
Part Number:
93-PLUG8PS

- Part Numbers:
93-PLUG2PS.....2 pins
93-PLUG3PS.....3 pins
93-PLUG5PS.....5 pins
93-PLUG8PS.....8 pins

93-PLUG2PSExtra Screw Terminal Conn., 2 Pin Plug, 3.5mm	\$2
93-PLUG3PSExtra Screw Terminal Conn., 3 Pin Plug, 3.5mm	\$3
93-PLUG5PSExtra Screw Terminal Conn., 5 Pin Plug, 3.5mm	\$5
93-PLUG8PSExtra Screw Terminal Conn., 8 Pin Plug, 3.5mm	\$8



OP-TERMBLK26



OP-IDC16/3



OP-DR/2RELAY

External DIN Rail Mounting Breakout Box

OP-DR/2RELAYDin Rail - 2 Relay Modules	Call
OP-DR/2LOGICDin Rail - 2 Logic Modules	Call
OP-IDC16/316 Pin IDC Cable - 3 Feet (using ISS7/8 Input Modules only)	\$55
OP-IDC26/326 Pin IDC Cable - 3' (using OR81/82 Output Modules only)	\$65
OP-RIB16/116 Pin Ribbon Cable - 1' (using ISS7/8 Input Modules only)	Call
OP-RIB26/126 Pin Ribbon Cable - 1' (using OR81/82 Output Modules only)	Call
OP-TERMBLK1616 Pin Din Rail Terminal Block (using ISS7/8 IIMs only)	\$65
OP-TERMBLK2626 Pin Din Rail Terminal Block (using OR81/82 OMs only)	\$85

Custom Faceplates please see page 59

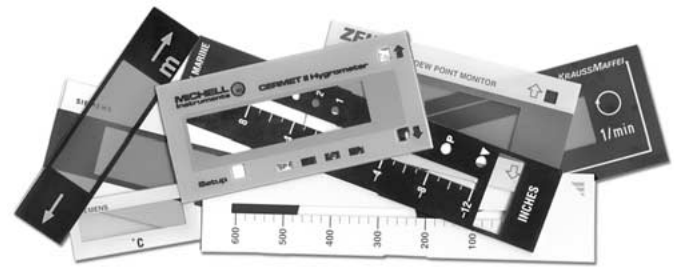

Custom Faceplates

We Produce Thousands of Custom OEM Face Plates

Have Us Design and Build a Custom Face Plate to Suit Your Next Project!



- Custom face plates have a non-recurring artwork charge. A serial number is then assigned to each artwork, to facilitate re-ordering.
- Small Run or One-Off custom face plates incur an installation charge, and are generally printed on a special plastic film, which is then laminated to custom faceplate blanks as required.

- The non-recurring artwork charge is less if you choose elements from our library. The standard scales and numbers in the library are shown on the right ▶
- Large Run (250 pieces min): custom face plates are production silk screened, issued a part number, and held in stock for free installation as required by customer orders.
- OEMs may also order Custom Meter Labels, Box Labels

Custom Data Sheets and Instruction Manuals.

- Large Run (250 pieces min): custom face plates are production silk screened, issued a part number, and held in stock for free installation as required by customer orders.
- OEMs may also order Custom Meter Labels, Box Labels Custom Data Sheets and Instruction Manuals.

Part Number	Description	List
-------------	-------------	------

Custom Face plates for Meters

ART-FS-S/D	Custom Faceplate, No Min. - Artwork & set-up	\$35
ART-FS-S/D/C	Custom Faceplate, No Min. - Artwork & set-up + Logo	\$75
ART-FS-001	Produce & Install Custom Faceplate per meter - 1 color	\$10
ART-FS-002	Produce & Install Custom Faceplate per meter - 2 color	\$20
ART-FS-003	Produce & Install Custom Faceplate per meter - 3 color	\$30

Specify artwork serial number when ordering face plate installation. ie: AFS-XXXX

Large Run Custom Face plates for Meters

ART-FL-S/D/C	Custom Faceplate, 250 Min. - Artwork & set-up + Logo	\$75
ART-FL-001	Custom Faceplate, 250 Min. (\$1.00 each) - 1 color	\$250
ART-FL-002	Custom Faceplate, 250 Min. (\$1.40 each) - 2 color	\$350
ART-FL-003	Custom Faceplate, 250 Min. (\$1.80 each) - 3 color	\$450

When ordering Large Run Face plates to be installed, please specify the custom part number issued for each different artwork. ie: 77-DLXXXX

Optional Caption Sheets (white or black lettering for do-it-yourself customizing)

AHEAD	AC Vars	AC Amperes	AC Kilowatts	AIR PRESSURE	AC Milliamperes
ALARM	AC Volts	AC Kilovars	AC Millivolts	AC Kiloamperes	Battery Voltage
BOILER	AC Watts	AC Kilovolts	BPH X 1000	AC Megavars	Backup Voltage
Cycles	BEARING	AIR FLOW	CFH X 1000	AC Megawatts	Displacement
Depth	COOLANT	BBLs/HOUR	DC Amperes	AC Watts/Vars	DC Amps to Ground
HEATER	DC Volts	BFM AMPS	DC Kilovolts	CENTIMETERS	DC Microamperes
Height	DC Watts	BHP x 100	DC Kilowatts	DC Kiloamperes	DC Milliamperes
Hertz	Degrees	BLOWER	DC Millivolts	FD FAN AMPS	GALLONS / MINUTE
Hours	ENGINE	DC Current	FPM X 100	IN. H ₂ O PRESS	GENERATOR AMPS
INCHES	EXHAUST	Dew Point	FPM X 1000	LBS/MINUTE	LBS PER GALLON
Input	Humidity	Degrees C	GPM X 1000	LEVEL INCHES	LOAD LIMIT PERCENT
PORT	METERS	Degrees F	HORSEPOWER	LEVEL PERCENT	MANIFOLD PRESSURE
PUMP	Output	Degrees K	INCHES WC	LEVEL PERCENT	MILL LOAD AMPS
Presat	Percent	Degrees R	INCHES H ₂ O	MILLIMETERS	MOTOR LOAD AMPS
Reset	Program	FPM X 10	KILOWATTS	Percent Current	Percent Horsepower
SHAFT	Pounds	Frequency	LBS X 1000	Percent Load	OXYGEN PERCENT
SPEED	Pulses	FUEL FLOW	MEGAWATTS	PERCENT OPEN	TEMPERATURE °C
Setup	RUDDER	GALLONS	Power Factor	RATE of TURN	TEMPERATURE °F
TABLE	SPINDLE	IN. WATER	Phase Angle	STEAM TEMP °F	Motor Load Percent
Total	SQ ROOT	LEVEL FT.	RPM X 100	TONS / HOUR	LEFT RIGHT
VALVE	Set Point	LBS X 100	STARBOARD	OIL PRESSURE	FRONT REAR
Valley	THRUST	POSITION	TANK LEVEL	WATER LEVEL	FORWARD REVERSE
WATTS	TURBINE	TONS X 10	VAC MM HG	1000 LBS/HOUR	TOP BOTTOM (L418)

A	AC	E _b	Btu	bars	CFH	BHP	Low	inch/	CosØ	AMPS	BBL/HR
J	Ah	kj	bar	cal ₁₅	CFM	IPS	High	Kcal	FEET	GALS	BBL/MIN
K	cd	kV	cal	cm ⁻¹	CFS	IPH	MGD	kg/hr	Hold	INHg	DEG/MIN
l	dB	kW	cm	cm ²	COS	Kg/h	Mid	kVAR	Km ³ /h	m/min	FT H ₂ O
m	DC	ml	FT ³	cm ³	CPH	KPH	MPH	kW/s	MWH	m/sec	In. H ₂ O
V	FT	NL	lbs	dm ³	CPM	KPM	MPS	RPM	mWs	Nm ³ /h	Kg/cm ²
α	HP	Pa	IN ²	H ₂ O	CPS	KPS	N/m ²	MPM	mbar	Ohms	KNOTS
β	Hz	PF	kg/	kPa	DCA	kWH	ORP	M ³ /hr	ml/m ³	PSIA	kg/sec
φ	Kg	pH	mA	l/s	FPH	lb/ft	PPH	Upm	mm/s	PSID	Mvars
Ω	kA	sin	mS	l/h	FPM	lb/in	PPM	VAC	Peak	PSIG	mmH ₂ O
Δ	L ³	t/h	mV	l/m	FPS	LPH	PPS	Vars	PORT	PSIR	mmHg
∂	W	μA	oz	MW	GMP	LPS	RPS	w/m ²	TARE	TORR	%LOAD
∇	°C	μS	RH	min	GPH	m ³ /h	phi	YPM	TONS	U/min	%OPEN
%	°F	μV	1/h	mm	GPM	m ³ /m	psi	YPS	X100	X10kN	
∠	°K	μΩ	μm	Sm ³	GPS	m ³ /S	X10	μPa	%KW	X1000	

Sample Caption Sheet not to scale

Custom Faceplate Design Template



62 mm
(2.44")

134 mm (5.28")

NEMA-4X Water and Dust Proof Membrane Touch Pad Panel



Case Dimensions

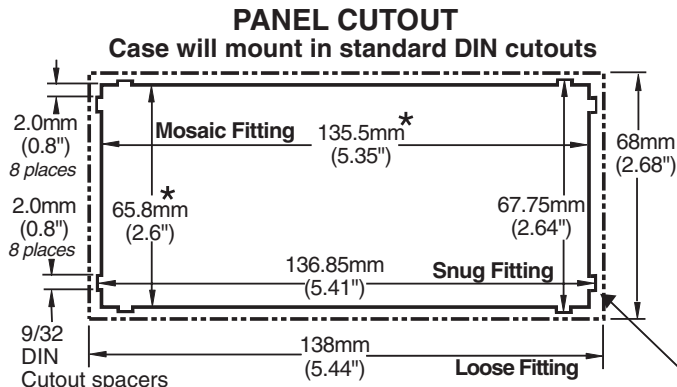

* These dimensions are increased by 2mm (0.08") when the metal surround case is installed.

For extra strength in portable applications, the 8 DIN spacers should be snipped off and the **Mosaic fitting** cutout used. Alternatively, the **High Strength Panel Mounting Kit** can be used.

SIDE VIEW

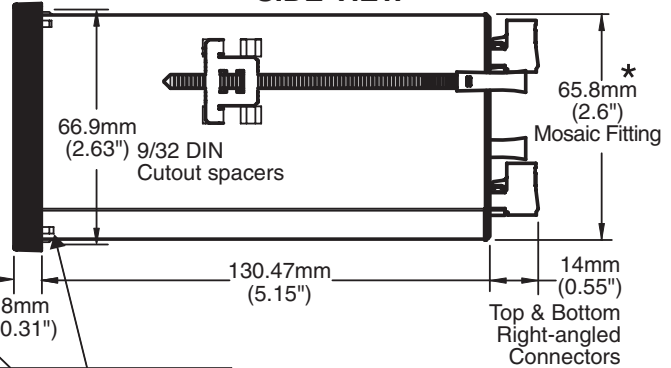

Metal Surround Case

P/N:(OP-MTL144X72)

NOTE: The Metal Surround Case is pre-installed at the factory and cannot be removed without damage to the case.

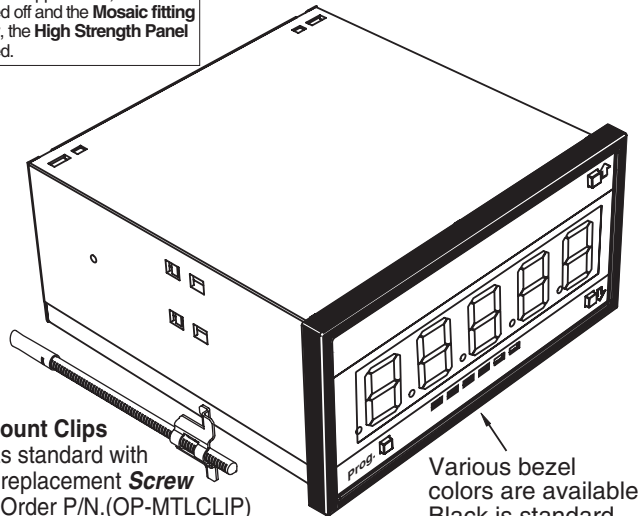
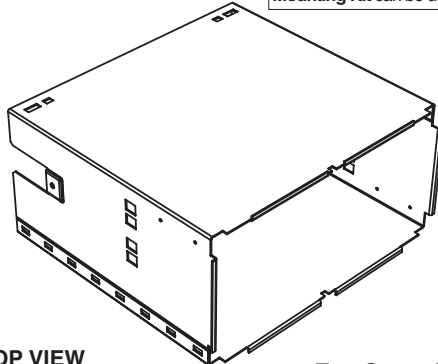

Various bezel colors are available. Black is standard.

Two Screw Mount Clips are supplied as standard with this case. For replacement **Screw Mount Clips**, Order P/N.(OP-MTCLIP)

FRONT VIEW

9/32 DIN 144x72mm

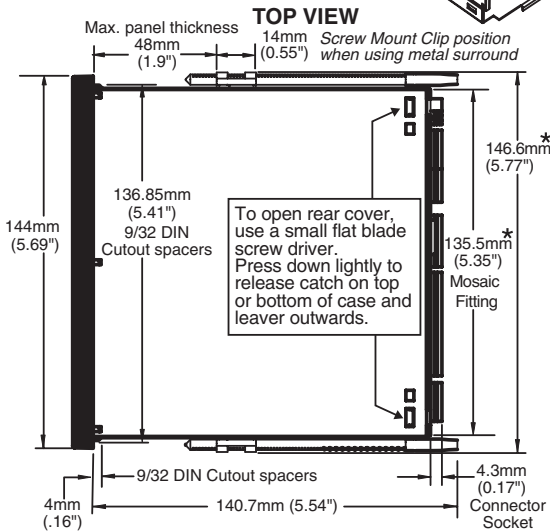

To open rear cover, use a small flat blade screw driver. Press down lightly to release catch on top or bottom of case and lever outwards.

Panel adaptor plates are available to retrofit most existing panel cutouts.

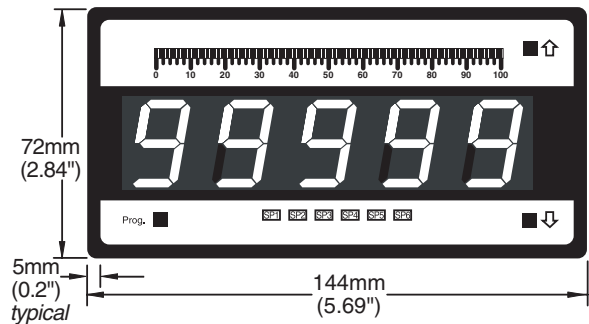

WARRANTY

Texmate warrants that its products are free from defects in material and workmanship under normal use and service for a period of one year from date of shipment. Texmate's obligations under this warranty are limited to replacement or repair, at its option, at its factory, of any of the products which shall, within the applicable period after shipment, be returned to Texmate's facility, transportation charges pre-paid, and which are, after examination, disclosed to the satisfaction of Texmate to be thus defective. The warranty shall not apply to any equipment which shall have been repaired or altered, except by Texmate, or which shall have been subjected to misuse, negligence, or accident. In no case shall Texmate's liability exceed the original purchase price. The aforementioned provisions do not extend the original warranty period of any product which has been either repaired or replaced by Texmate.

USER'S RESPONSIBILITY

We are pleased to offer suggestions on the use of our various products either by way of printed matter or through direct contact with our sales/application engineering staff. However, since we have no control over the use of our products once they are shipped, NO WARRANTY WHETHER OF MERCHANTABILITY, FITNESS FOR PURPOSE, OR OTHERWISE is made beyond the repair, replacement, or refund of purchase price at the sole discretion of Texmate. Users shall determine the suitability of the product for the intended application before using, and the users assume all risk and liability whatsoever in connection therewith, regardless of any of our suggestions or statements as to application or construction. In no event shall Texmate's liability, in law or otherwise, be in excess of the purchase price of the product.

Texmate cannot assume responsibility for any circuitry described. No circuit patent or software licenses are implied. Texmate reserves the right to change circuitry, operating software, specifications, and prices without notice at any time.



995 Park Center Drive • Vista, CA 92081-8397

Tel: 1-760-598-9899 • USA 1-800-839-6283 • That's 1-800-TEXMATE

Fax: 1-760-598-9828 • Email: sales@texmate.com • Web: www.texmate.com

Texmate has facilities in Japan, New Zealand, Taiwan, and Thailand. We also have authorized distributors throughout the USA and in 28 other countries.

For product details visit www.texmate.com

Local Distributor Address