

SD-Series

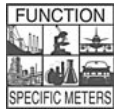

Touch-Pad Standard

Push-buttons Optional

SD-802XAI

4-20mA Loop Powered Dual Display with Dual Totalizer

Dual 8-Digit, 5.5mm High Dot Matrix LCD Display, 1/8 DIN Ultra Short Depth Case

Compatibility

The 1/8 DIN case style and panel appearance of the SD-802XAI meter matches Texmate's range of Lynx, Leopard, and Tiger 320 Series meter families. The depth behind the panel is only 15 mm (0.59"), increasing to just 27.5 with a connector attached. The SD-802XAI makes an ideal extra or remote display as it can operate in conjunction with the 4-20 mA loop input, or from the 4-20 mA analog output of most Leopard or Tiger 320 Series meters.

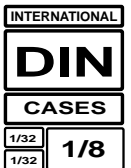

Typical Application Connections

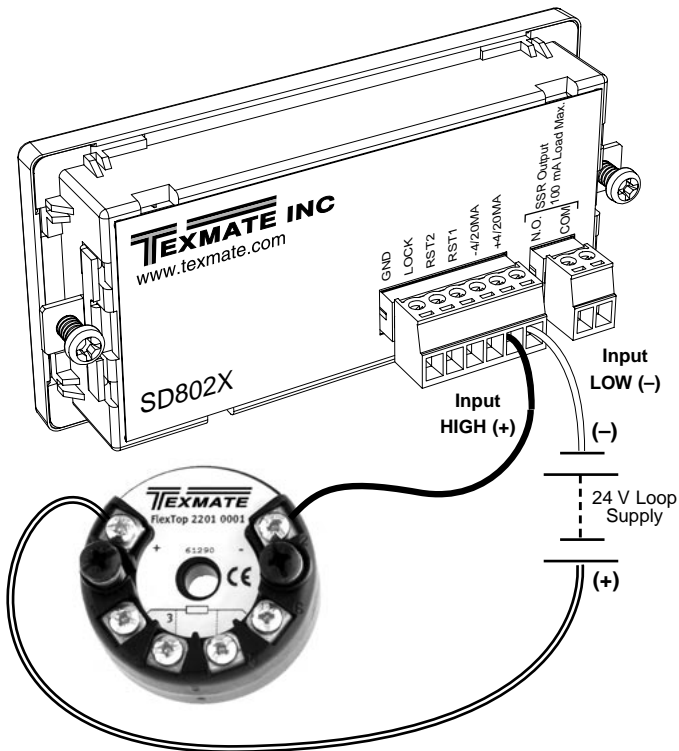

General Features

- Friendly front panel programming.
- Intuitive, user friendly calibration procedures.
- Single input channel with dual totalizers for sub and grand total processing.
- Smart digital filtering and programmable input averaging with averaging window for quick response time to large signal changes.
- Three external inputs using contact closures for resetting totalizer 1, totalizer 2, or preventing programming changes.
- One independent programmable setpoint.
- Setpoint activated from input or selected meter function.
- Setpoint hysteresis or deviation mode settings.
- Seven (7) relay timer modes.
- Single 210 mA, 400 VDC solid state relay (SSR).
- Relay latching.
- Manual relay reset.
- Programmable safety lockout to prevent tampering.
- Peak and valley retention.
- Optional NEMA-4 front cover.
- Square root extraction.

Table of Contents

Calibration Mode6	Functional Diagram42
Case Dimensions48	Meter Programming Logic Trees5
Connector Pinouts42	Model and Software Code Version Check44
Contrast Mode6	Ordering Information48
Controls and Indicators2	Programming Conventions4
Custom Faceplates43	Setpoint Programming Mode24
Customer Code Settings45	Signal Filtering Mode16
Display 1 Source Mode18	Specifications2
Display 2 Source Mode20	Totalizer Mode8
Display Format Mode22		
Document Revision History48		

Specifications

Input Configuration:Series connection to 4-20 mA DC current loop. 3.4 volts drop plus 20 Ω (equivalent to 3.9 V @ 20 mA), plus 2.3 V drop if Single solid state relay (SSR) installed

Relay Output: SSR. Max 210 mA, 400 VDC ONLY

Display:Dual 8-digit, 5.5 mm high, 5 x 8 format dot-matrix Liquid Crystal Display (LCD)

Polarity:Assumed positive, displays – negative

Display Range:–9900000 to 9900000

Display Update:0.5 secs

Internal Resolution:16-bits

A/D Converter:16-bit Sigma Delta

Accuracy (Standard):±0.02% of reading ± 2 digit (typical)

Conversion Rate:10 samples per second

Temp. Coefficient:Typically 30 ppm/ °C

Descriptors:.....Any ASCII character selectable

Decimal Point:.....Front panel, user programmable to seven positions

Operating Temperature: -10°C to +50°C

Storage Temperature:.....-20°C to +70°C

Warm Up Time:1 minute

Relative Humidity:.....95% (non-condensing)

Case Dimensions:1/8 DIN, Bezel: 96x48 mm (3.78"x1.89").
Depth behind bezel 15 mm (0.59") plus
16.4 mm (0.65") for right-angled connector

Weight:56.7 gms (2 oz)
141.7 gms (5 oz) when packed

Case Material:Polycarbonate

Lens Cover:NEMA-4, (optional)

Underrange Indication:..Input signal below approx. 3.3 mA displays [LOW input] reading

Overrange Indication:....Input signal above approx. 27.7 mA displays [OVER] reading



Programming Buttons

PROGRAM:Move from one program step to the next

UP:Increase the value of the displayed parameter

DOWN:Decrease the value of the displayed parameter

Application Functions

Totalizer:Two totalizers are available. The totalizer calculates the running total of a process signal being metered by accumulating an input process variable over time

Peak and Valley:The meter can retain peak and valley (min/max) information and recall this on the front panel

Setpoints:SP1 resets a selected function and / or activates Relay 1

Controls and Indicators

Front Panel Controls and Indicators



Program Button

Pressing the **Prog** and **UP** buttons at the same time enters the **main programming mode**. This allows you to configure the meter's main functions.

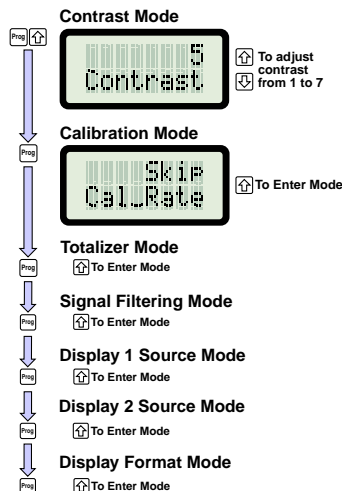

Pressing the **Prog** and **DOWN** buttons at the same time enters the **setpoint programming mode**.

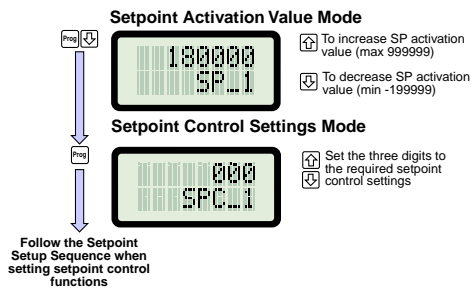

While programming, pressing the **Prog** button saves the current programming settings and moves on to the next programming step or mode.



To save a new mode configuration setting and return to the operational display, press the **Prog** button once and then press the **Prog** and **UP** buttons at the same time.

You can move through the programming modes using the **Prog** button while [Skip] toggles with the mode name. The modes you pass are not affected unless you enter using the **UP** button and make changes using the **UP** or **DOWN** buttons.

Up Button

When setting a displayed parameter during programming, press the  button to increase the value of the displayed parameter.

UP Button View Mode

When in the operational display, pressing the  button initiates a viewing mode that allows you to view the readings on total 1, peak, and channel 1. Once into the viewing mode, pressing the  button moves through each displayed parameter.

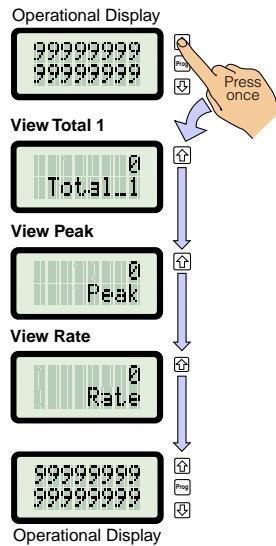

Press the  button to return to the operational display.



Down Button

When setting a displayed parameter during programming, press the  button to decrease the value of the displayed parameter.

DOWN Button View Mode

When in the operational display, pressing the  button initiates a viewing mode that allows you to view the readings on total 2, valley, and setpoint 1. Once into the viewing mode, pressing the  button moves through each displayed parameter.

Press the  button to return to the operational display.

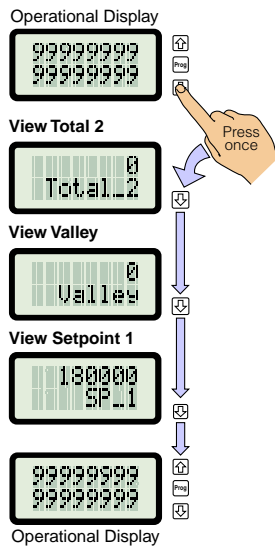

Dual Dot-matrix LCD Displays

Display 1 is the **top** display of eight digits in a 5 x 8 dot-matrix LCD format.

Display 2 is the **bottom** display of eight digits in a 5 x 8 dot-matrix LCD format. Displays 1 and 2 are used to display the meter input signal readings. They also display the configuration setup modes and settings during programming.

Last Digit ASCII Character Set

One of the following ASCII characters can be selected as a descriptor in the last digit of either display. The arrows show the order the characters appear when pressing the  button during programming.

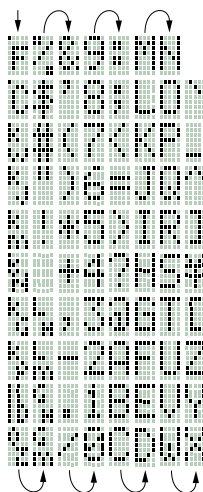

Error 1 Message

An **Error 1** message can occur during calibration procedures. The bottom display reads [Error 1] for about 2 seconds and then returns to the [Skip] [Cal_Rate] display. The three most likely causes of an error 1 message are:

- 1) The scaling requirement exceeded the capability of the meter (-9900000 to +9900000).
- 2) No input signal present, or no difference between low and high input during calibration.
- 3) Incorrect connections.

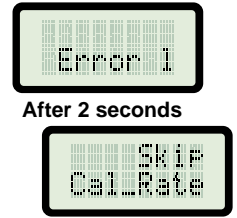

Low Input Message

The [**Low Input**] message occurs when the current loop current is enough to light the display, but not enough to drive the meter software. This occurs at approximately 3.3 mA.

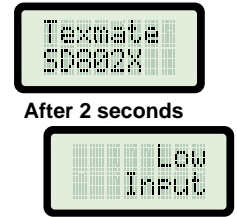

OVER Message

The [**OVER**] message occurs when the current loop current goes overrange. This occurs at approximately 27.7 mA.

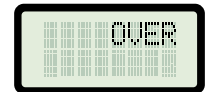



Rear Panel Controls and Indicators

Programming Lockout Pin

When connected to the GND (ground) pin, the LOCK pin prevents any programming changes being made to the meter, except to the contrast.

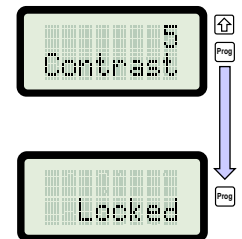
If an attempt is made to enter the **main programming mode**, the meter enters the contrast mode and allows the contrast to be changed.



Pressing the  button again displays the word [Locked]. Further pressing of the  button displays the programming modes but settings cannot be changed.

Attempting to enter the **setpoint programming mode** immediately displays the word [Locked]. Further pressing the  button enters the setpoint programming mode but settings cannot be changed.

Totalizer 1 Reset Pin

When connected to the GND pin, the RST1 pin resets totalizer 1 to zero.

Totalizer 2 Reset Pin

When connected to the GND pin, the RST2 pin resets totalizer 2 to zero.

The meter uses a set of intuitive software modes to allow maximum user flexibility while maintaining an easy programming process. When configuring the setpoint programming mode, the meter uses the three right-hand side display digits on the top display (display 1). These are known as the first, second, and third digits and can be seen in the diagram opposite.

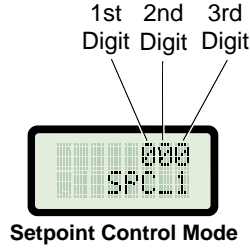

To explain software configuration procedures, diagrams are used to visually describe the programming steps. The following conventions are used to represent the buttons and indicators on the meter, and the actions involved in programming the meter:

Symbol **Explanation**

 This symbol represents the **OPERATIONAL DISPLAY**. After the meter has been powered up, the display settles and indicates the calibrated input signal. This is known as the operational mode and is generally referred to as the operational display throughout this document.

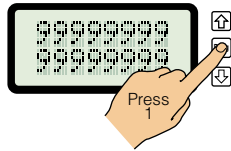

All programming modes are entered from this level.

 This symbol represents the **PROGRAM** button. In a procedure, pressing the program button is always indicated by a **left hand**. A number indicates how many times it must be pressed and released.



 This symbol represents the **UP** button. Shown in a diagram, pressing the UP button is always indicated by a **right hand**.

 This symbol represents the **DOWN** button. Shown in a diagram, pressing the DOWN button is always indicated by a **right hand**.

Where two right hands are shown on the same diagram with the word **OR** between them, this indicates that both the  and  buttons can be used to adjust the display: UP for increase, DOWN for decrease.

[Span] Text or numbers shown between square brackets in a description or procedure indicate the programming mode name of the function or the value displayed on the meter display.

[10000]



Programming Procedure Diagrams

The programming procedures described in this manual are graphic based diagrams with little descriptive text.

Each procedure shows a number of meter panel displays running in procedural steps from the top to the bottom of the page.

If need be, the procedure may run into two columns with the left column running down the page and continuing at the top of the right-hand column. Each action performed by the user is shown as a numbered step.

Each procedural step shows the meter display as it looks before an action is performed. The hand or hands in the procedural step indicate the action to be performed and also how many times, or for how long, the button is to be pressed.

For example, the diagram below shows the meter in the operational display. With a left hand pressing the  button and a right hand pressing the  button, the user is entering the main programming mode.

This is indicated by the next diagram displaying [5] and [Contrast]. This is the first configuration mode of the main programming mode.

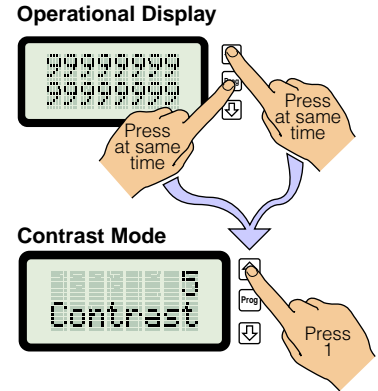

Where a left and right hand are shown on separate buttons on the same diagram, this indicates that the buttons must be pressed at the same time.

Where a number is not definable, the default setting [000] is shown.

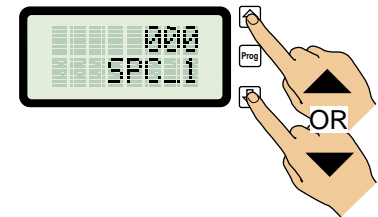

If an X appears in the description of a 3-digit setpoint programming mode procedure, this means that more than one choice can be made, or any number displayed in that digit is not relevant to the function being explained.

The **main** and **setpoint** programming modes are accessible from the operational display.

Main Programming Mode

The main programming mode provides access to program all meter functions, except setpoints.

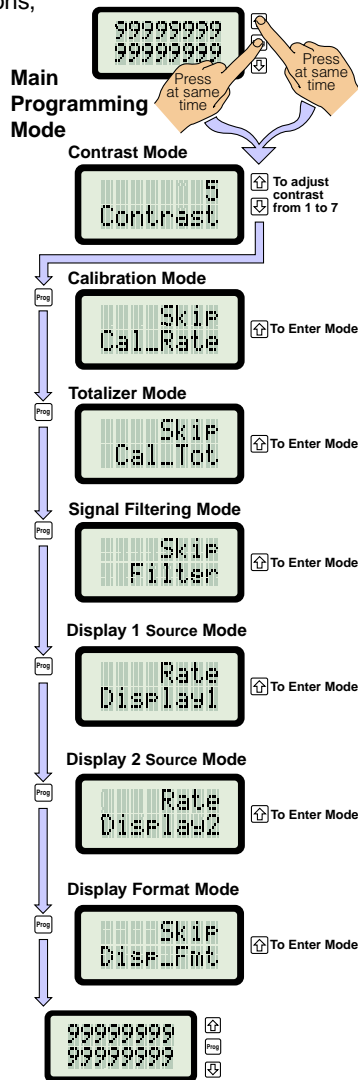

View Modes

While in the operational display, pressing the **Up** button allows you to view but not change the following parameters:

- The current value in **totalizer 1**.
- The current **peak** value.
- The current display on **rate**.

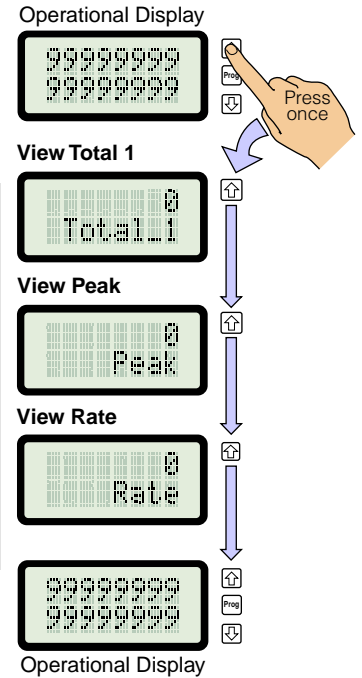

Note:

While in the **total 1** view mode, pressing the **Up** and **Down** buttons at the same time resets totalizer 1 to 0 (zero).

While in the **peak** view mode, pressing the **Up** and **Down** buttons at the same time resets peak to the current input signal display reading.

Setpoint Programming Mode

The setpoint programming mode provides access to program all setpoint 1 activation and control functions.

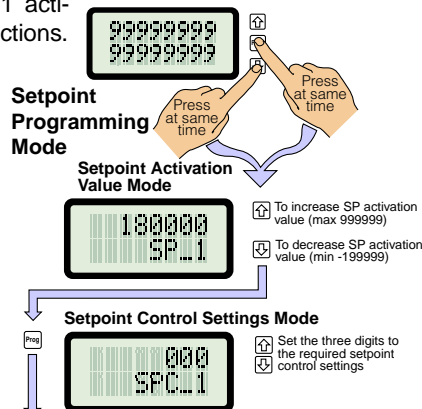

Follow the Setpoint Setup Sequence when setting setpoint control functions

Note:

While in the **total 2** view mode, pressing the **Up** and **Down** buttons at the same time resets totalizer 2 to 0 (zero).

While in the **valley** view mode, pressing the **Up** and **Down** buttons at the same time resets valley to the current input signal display reading.

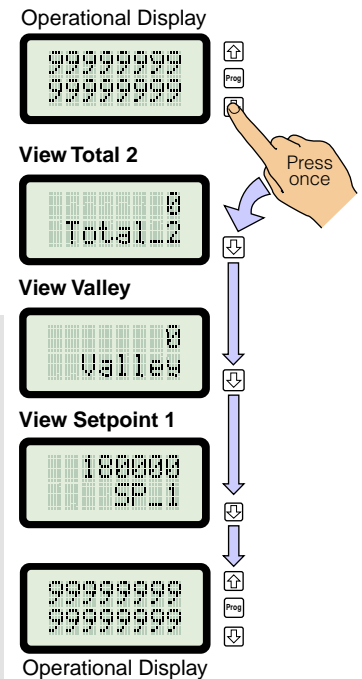

Main Programming Mode

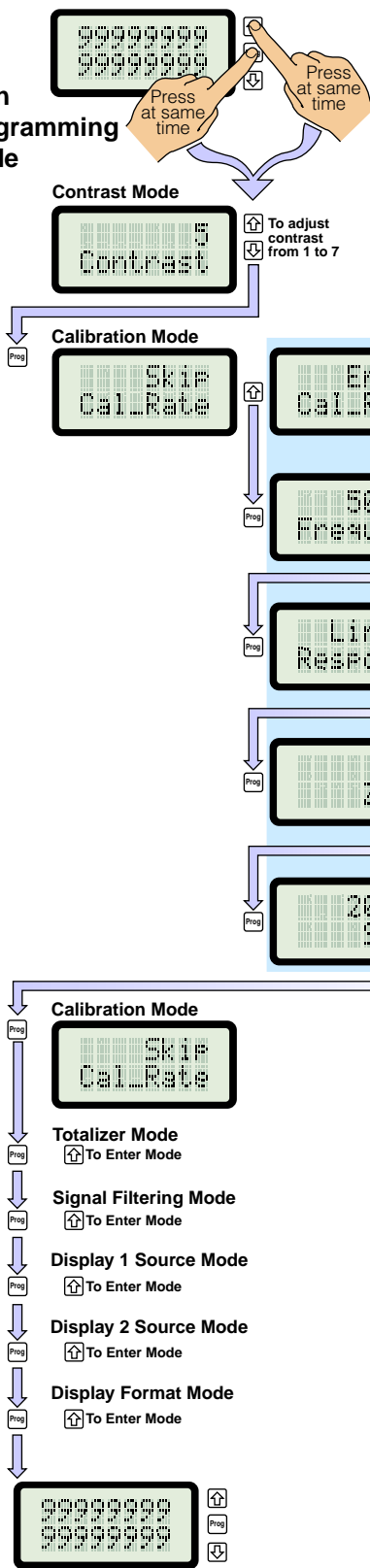

Contrast Mode

Press the **Prog** and **↑** buttons at the same time to enter the **main programming mode**. The **contrast mode** is the first mode that appears. This mode allows you to adjust the display contrast in a range from 1 to 7, with 1 being the least contrast and 7 being the most contrast. While in this mode, pressing the **↑** button increases the contrast and pressing the **↓** button decreases the contrast.

Calibration Mode

The **calibration mode** follows the contrast mode. It allows you to:

- Select input frequency rejection of **50** or **60** Hz.
- Select **linear** or **square root** response.
- Scale the input signal through **zero** and **span** settings.

Noise Rejection Selection

Press the **↑** button to enter the **calibration mode**. The first setting displayed is the **noise rejection setting** [Frequency] [50 hZ]. This setting allows you to choose between 50 and 60 Hz noise rejection.

Response Setting

After selecting the noise rejection setting, press the **Prog** button to enter the **response setting** [Response] [Linear].

Input Signal Scaling

This is a two-point calibration procedure that requires a low and high input signal source for calibrating the zero and span settings.

After selecting the response setting, press the **Prog** button to enter the **zero setting** [Zero] [0]. Apply the **low** input source to the meter and, using the **↑** and **↓** buttons, set the zero setting between -9900000 and 9900000 counts.

When the zero setting has been set, press the **Prog** button to enter the **span setting** [Span] [20000].

Now apply the **high** input source to the meter and, using the **↑** and **↓** buttons, set the high setting between -9900000 and 9900000 counts.



Example Procedure

The following example procedure shows how to calibrate the input signal from 0 to 5,000 counts for a linear signal in the 50 Hz input frequency range.

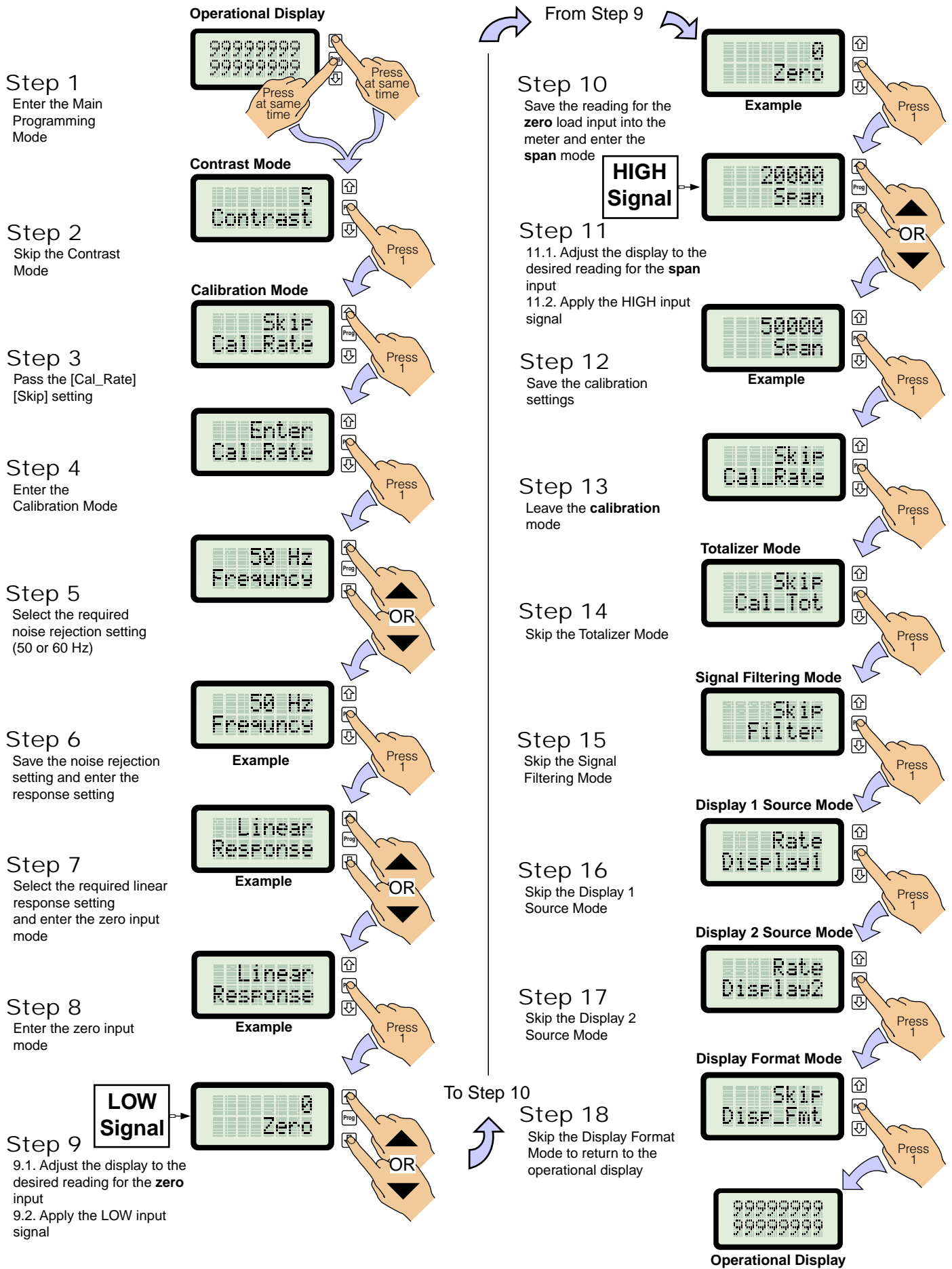

Main Programming Mode

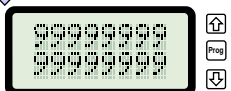
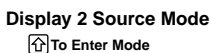
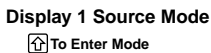
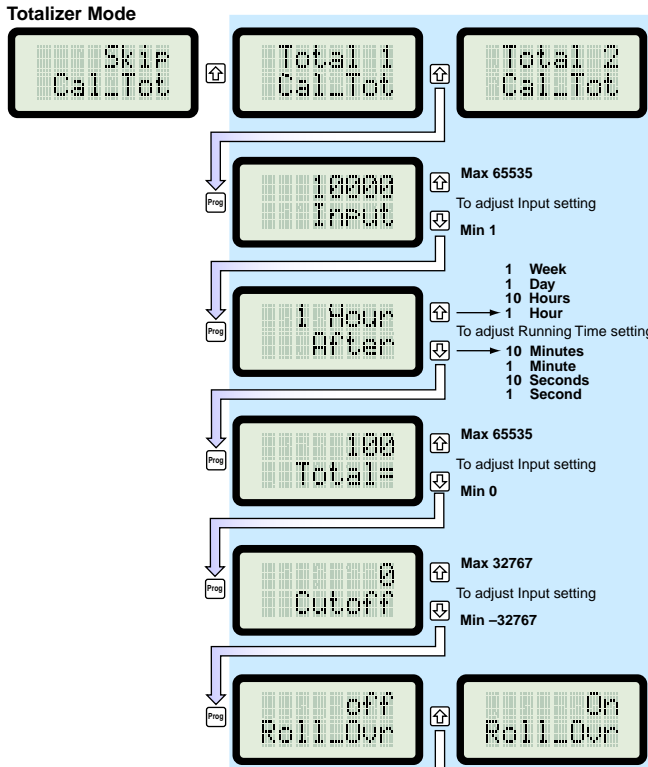
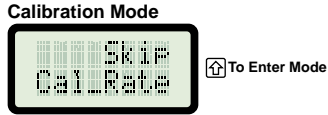
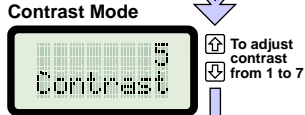
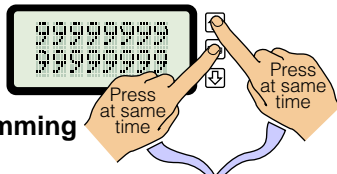

Press the **Prog** and **↑** buttons at the same time to enter the main programming mode. Press the **Prog** button again to skip the calibration mode. The meter displays [Cal_tot] [SKiP]. This is the **totalizer mode**.

Press the **↑** button to enter the totalizer mode. The meter displays [Total_1]. This is totalizer 1. If you wish to configure totalizer 2 press the **↓** button again. The meter displays [Total_2]. This is totalizer 2.

With either [Total_1] or [Total_2] displayed, pressing the **Prog** button again allows you to enter the selected totalizer and configure the required totalizer settings.

Using the Totalizer

A totalizer is a user selectable software function of the meter that converts an input rate to an input total over time. For example:

A customer has a settling tank being filled with water. An SD-802XAI meter is connected to the current loop of a flow meter. The flow rate indicates the speed at which the volume of water travels past a set point, but not the total volume accumulated in the tank. The SD-802XAI totalizer performs this function and provides the customer with the total amount of water currently in the tank.

The SD-802XAI meter has two independent totalizers suitable for a wide variety of totaling and batching applications. Each totalizer can operate independently or combine to generate a sub-total and grand total. Totals can be reset using one of a number of methods. The setpoint can be used to reset a sub-total and increment a grand total.

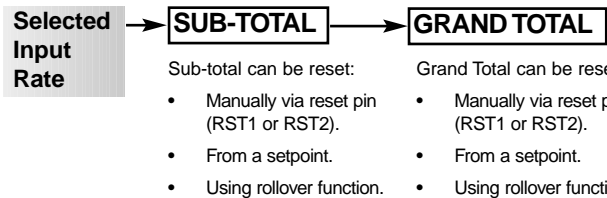

Before You Start Setting the Totalizer

Configuring the meter for a totalizer application requires some basic settings to be decided beforehand. These settings are the unit input rate, the resolution of the unit input rate, and the resolution of the totalizer. When the settings are known, enter the calibration mode and calibrate the input channel.

Unit Input Rate

This is the term for the unit amount of the input signal to be totalized in relation to time. For example, the unit input rate of a flow rate of 100 liters per second is liters per second. Some other examples of the unit input rate would be revolutions per minute or joules per hour.

Input Signal Resolution

This uses the position of the decimal point to determine how coarse or how fine the units of the input signal are displayed on the meter.

Input Signal Calibration

The input signal must be calibrated to suit the unit input rate, taking into consideration the required input signal resolution. For example:

If we wanted to display an input flow rate of 350 gallons per minute (GPM) in tenths (0.1) of a gallon, the meter could be scaled to read 0 counts for 0 GPM and 3500 counts for 350 GPM. With the input signal resolution set to tenths, the meter would then display 350.0 counts for 350 GPM, or 276.9 counts for 276.9 GPM.





Totalizer Resolution

This also uses the position of the decimal point to determine resolution. In this case it is how coarse or how fine the units of the totaled amount are displayed on the meter. For example:

Using our 350 GPM flow rate again, we want to display 1 kilogallon for every 1,000 gallons totaled. With the display resolution configured with no decimal point, we would add 1 to the totalizer after 1,000 gallons. But, if we wanted the totalizer to display to the nearest 100 gallons, we would then place the decimal point between the last two digits. Therefore, 1,000 gallons would display as 1.0 on the totalizer, but 1,652 gallons would display as 1.6.

Totalizer Settings

Entering the totalizer settings mode allows you to configure the following settings for the selected totalizer:

- **Input Rate.** Displayed as: 
- **Running Time.** Displayed as: ... 
- **Required Total.** Displayed as: ... 
- **Cutoff.** Displayed as: 
- **Rollover.** Displayed as: 

Input Rate [Input]

The input rate has a default setting of 10,000 counts. This can be adjusted to suit the known input rate of an application.

So, using our 350 GPM flow rate example, to display in units of 1 gallon we can adjust the input rate from 10,000 counts to 350 counts. Or, if we wanted to display the total in tenths of a gallon, we can adjust the input rate to 3500 counts, making sure the totalizer resolution is set for tenths (0.1). This gives us a display of 350.0 for 350 GPM.

Running Time [After]

The running time is the period over which the input rate is accumulated to obtain the required total value. The following running times are selectable in the meter:

Running Times				
Seconds	Minutes	Hours	Days	Weeks
1	1	1	1	1
10	10	10	-	-

Total Required [Total =]

This is the total you wish to see after a selected running time. The time unit of the input rate is normally selected as the running time. For example, if gallons per minute is the rate unit, then you would use 1 minute as the running time. Or, if liters per hour is the rate unit, then you would use 1 hour as the running time.

So once again, using our 350 GPM flow rate, the running time is 1 minute. This means that when we set the required total, it is with the understanding that the total is expressed as a unit of gallons per minute. For example:

If we wish to display 1 kilogallon for every 1,000 gallons totaled, we would set the required total to 1.

But, if we wanted the totalizer to display to the nearest 100 gallons, we would have to move the decimal point to add an extra unit. Therefore, instead of setting the required total as 1, we would set it to 10. The 1,000 gallons would then display as 1.0 on the totalizer as long as the input signal resolution is set to 0.1 (tenths).

Cutoff [Cutoff]

This is normally set to 0 to prevent counts being subtracted from the total, but it can be set anywhere from -32767 to 32767 counts, depending on the application.

For example, if the meter is scaled from 0 to 100 counts for a 4-20 mA input and the input power goes off, -25 counts would be subtracted from the total for the 0 mA signal. With cutoff set to 0.0, the totalizer ignores any counts below this setting (i.e. -25 counts).

Rollover [Roll_Ovr]

When set to ON, rollover automatically resets the total to 0 (zero) when the total value exceeds the maximum count of 999,999 on the display by one count. If the total is exceeded by more than one count, the amount over the maximum display is added to the new total.

Note, the rollover mode does not increment any other totalizer to record the rollover.

Rollover Example





Current Total		New Total
999999	+ 1 Rollover resets to	0
999999	+ 2 Rollover resets to 0 and 1 is added to new total	1
999999	+ 9 Rollover resets to 0 and 8 is added to new total	8



Note:
The rollover feature should not be used with the set-point reset feature as this could cause inaccurate results. See *Resetting the Total from a Setpoint*.

Resetting the Total

Resetting the total is an important feature of any totalizer or integrator. Both totalizers can be reset using one of the following methods:

- **Front Panel   Buttons.** Pressing both the  and  buttons on the front panel at the same time when the meter displays **total 1** or **total 2** in the view mode or operational display resets the selected total back to zero.
- **Reset Pins RST1 and RST2.** Connecting one of these pins to the GND (ground) pin resets the relevant totalizer back to zero.
- **Reset Totalizer 1 or 2 via the Setpoint.** Using a setpoint to reset one totalizer is the only method of incrementing the other totalizer.

See *Resetting the Total from a Setpoint* below.

- **Reset Totalizer 1 or 2 via Rollover Feature.**

See *previous Rollover description on Page 9.*

Press UP and DOWN buttons together

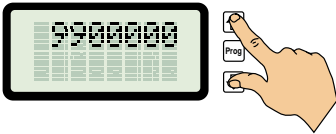

Selected TOTAL reset via Reset Pin

Rear of Meter

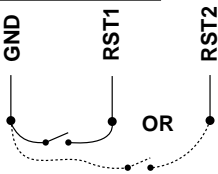

Selected TOTAL reset via setpoint

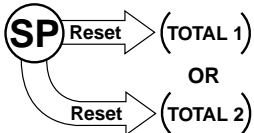

TOTAL 1 and/or TOTAL 2 reset via Rollover

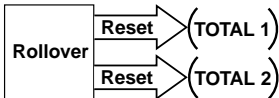

Resetting the Total from a Setpoint

The setpoint trigger & reset functions mode of the setpoint programming mode (see Page 37) allows any selectable function in the meter to be reset. This means that a selected totalizer can be programmed to reset at any setting within the range of the totalizer. This feature also allows one totalizer to be reset while the other totalizer increments by one count (sub-total increments grand total).

The graph on Page 11 uses a flow totalizer example with a sub-total and grand total to show the relationship between volume over time and the sub-total and total functions (either can be selected as total 1 or total 2).

Pulse Output

Some applications require a pulse output to be sent to other equipment such as a remote counting device. This is also a feature of the **setpoint trigger & reset functions mode** of the setpoint programming mode.

While resetting totalizer 1 or totalizer 2, a pulse output from the setpoint relay can increment the display on an external totalizer such as a remote counting device. When the total exceeds the setpoint setting, the setpoint activates and energizes the relay sending a pulse to the counting device. One sample time later (100 ms), the setpoint is not in violation (as it has dropped back to the reset value) and the relay is de-energized.

See *Totalizer Example – Advanced Totalizing of a Flow Input on Page 12* for full details on configuring a pulse output from a relay.

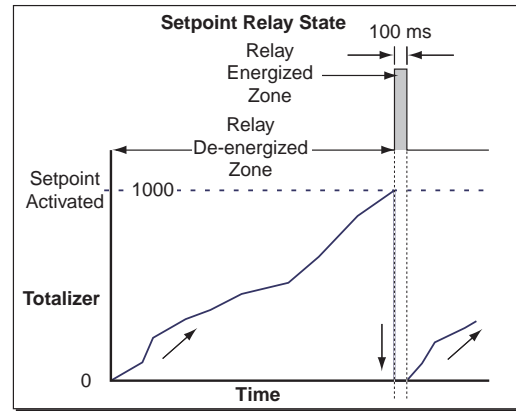

Graph showing Pulse Output

Totalizer Programming Sequence

When configuring the meter as a totalizer, the following programming sequence must be followed to ensure that all configuration settings are correctly entered and saved:

Step 1 Input Signal Calibration

- 1) **Set input signal resolution**
Enter the **display format mode** [Disp_Fmt] and set the resolution of the **rate** setting
- 2) **Set averaging sample & window settings**
Enter the signal filtering mode [Filter] and set the averaging samples and averaging window settings of the [Rate] setting
- 3) **Calibrate the input signal**
Enter the **calibration mode** [Cal_Rate] and calibrate the input signal

Step 2 Totalizer Resolution

- 1) **Set the totalizer resolution**
Enter the **display format mode** [Disp_Fmt] and set the decimal point to the required resolution for the selected totalizer

Programming sequence continued on next page

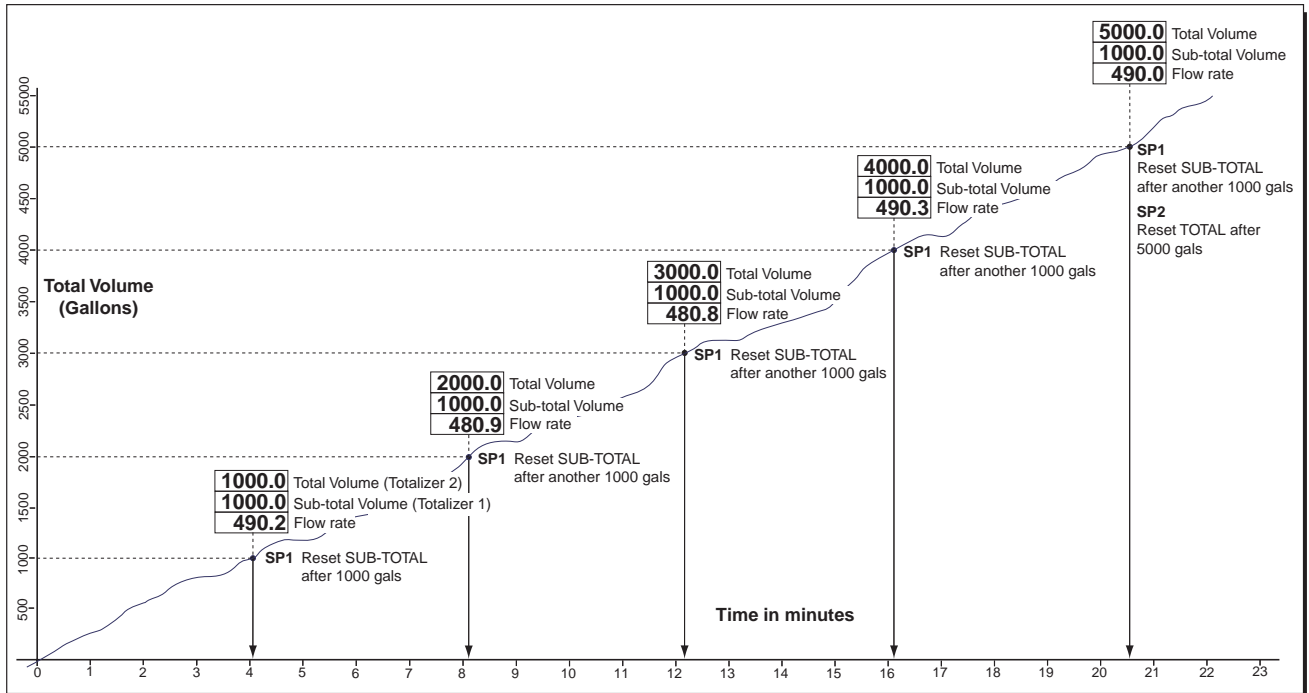

Graph showing Flow over Time with Sub-total and Total

Step 3 Totalizer Settings

1) **Configure the totalizer**

Enter the **totalizer mode** [Cal_Tot] and configure the following settings:

- a) Set the Input Rate
- b) Set the Running Time
- c) Set the Required Total
- d) Set the Cutoff Setting
- e) Select the Rollover Setting

Totalizer Resolution

Format the display of the selected totalizer. Select the position of the decimal point to suit your application and, if required, select an ASCII character for the last digit.

Totalizer Settings

Configure the totalizer settings to suit the totalizer application.

Main Display Source Setting

The last step is to select the source for the display. This can be either totalizer 1, totalizer 2, or rate (input signal).

Step 4 Main Display Source Setting

1) **Select the data for the main display**

Enter the **display source mode** [Display 1] and select [Total 1], or [Total 2], or [Rate] as the source for the main display



Note:

Instead of directly displaying the totalizer on the main display, you can directly display the input signal (rate). Both totalizers can still be viewed on the recall display using the view mode by pressing the \uparrow button for totalizer 1 and the \downarrow button for totalizer 2.

Input Signal Calibration

Before configuring the totalizer settings:

- Set the resolution (position of decimal point) for the [Rate] setting (input signal) in the display format mode.
- Set the averaging sample and averaging window settings for the [Rate] setting (input signal) in the signal filtering mode.
- Calibrate the input signal using the meter's built-in two-point calibration mode. The calibration method requires a low and high input signal to be applied when setting the zero and span settings.

Totalizer Settings Example: Advanced Totalizing of a Flow Input

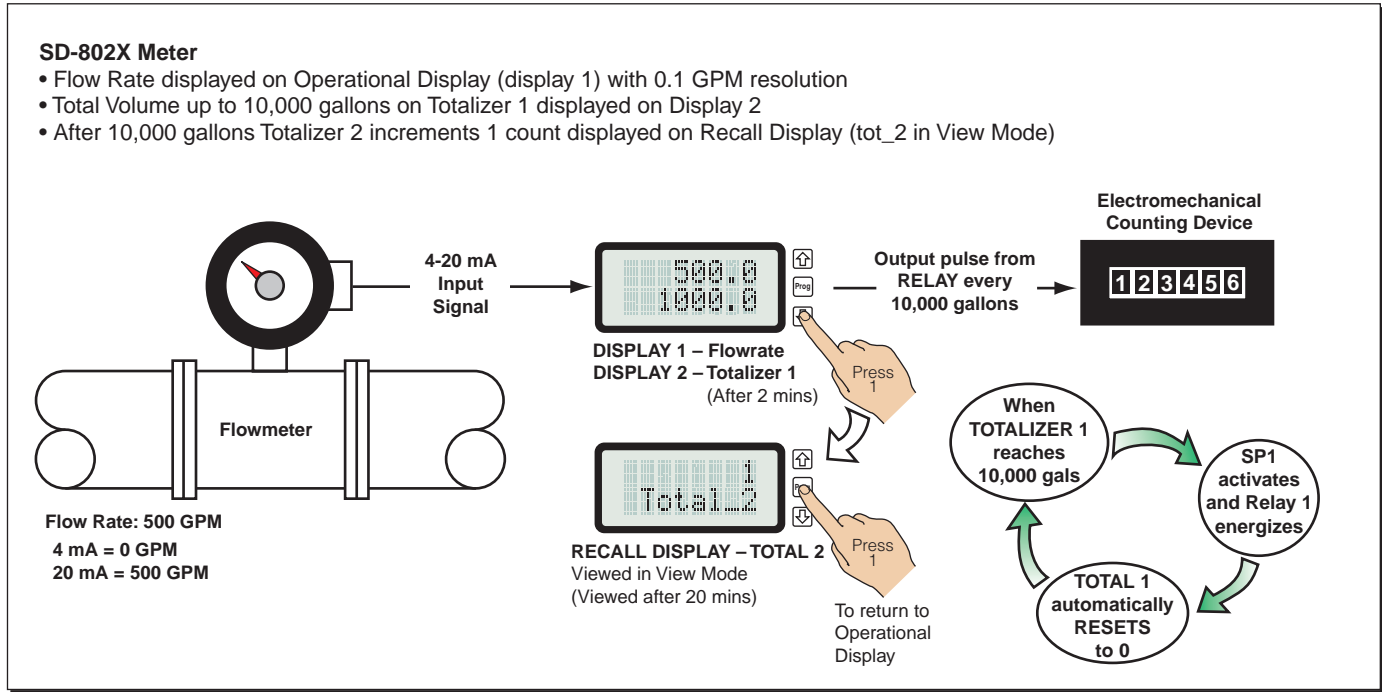

Example – Advanced Totalizing Functions

This section highlights the steps required to configure the meter as an advanced totalizer with pulse output. The example programming procedures on Pages 14 and 15 are written using this example.

In the above example, a 4-20 mA input represents a flow rate of 500 gallons per minute (GPM) with:

- 4 mA representing zero flow, and
- 20 mA representing 500 GPM.

Our customer requires:

- The flow rate displayed in units of 0.1 GPM on the operational display.
- The total volume up to 10,000 gallons calculated and displayed in units of 0.1 of a gallon on the recall display of Totalizer 1 in the **view mode**.
- A second total incremented by 1 count every 10,000 gallons on the recall display of Totalizer 2 in the **view mode**.
- A pulse output every 10,000 gallons to a remote totalizer (electromechanical counting device).



To View Totalizer 1:

Press the button to enter the recall display in the **view mode** and view Totalizer 1.

To View Totalizer 2:

Press the button once after viewing the Totalizer 1 recall display to enter the recall display in the **view mode** and view Totalizer 2.

Configuration Settings

To perform as our customer requires in the example, the input signal channel and totalizers 1 and 2 must be configured with the following settings:

Calibrate the Input Signal

- 1) Enter the **calibration mode**:
 - Set resolution of rate (input signal) to: **Tenths**
This positions the decimal point to display flow rate at **0.1 GPM** resolution
 - Set averaging filter to required settings for input signal conditions
 - Calibrate input signal over 0 to 500.0 GPM (0 to 5000 counts)

Configure the Totalizer Display

- 1) Enter the **display source mode** and select rate as the source for the operational display.
- 2) Enter the **display format mode** and set the resolution for total 1 and total 2:
 - Set **resolution** of totalizer 2 to: **Tenths**
This positions the decimal point to display **total 1** at **0.1 GPM** resolution
 - Set **resolution** of totalizer 1 to: **Ones**
This positions the decimal point to display **total 2** in units of 1 per 10,000 gallons

Configure the Totalizer Settings

1) Enter the **totalizer mode** and configure the following settings:

Total 1

- Set **input rate** to: 500.0 GPM (**5000** counts)
- Set running time to: **1 minute**
- Set the required **total** to: **500.0**
- Cutoff: **0**
- Rollover: **OFF**

Total 2

- Set **input rate** to: 500.0 GPM (**5000** counts)
- Set running time to: **1 hour**

At input rate of 500 GPM x 20 min, totalizer 2 displays **1** (10,000 gal). So after 1 hour, totalizer 2 displays **3** (30,000 gal).

- Set the required **total** to: **3**
Totalizer 2 displays **1** every 10,000 gallons recorded by totalizer 1
- Cutoff: **0**
- Rollover = **ON**

Setpoint 1 (for Pulse and Reset)

Activation Value:

- SP1 Activation Value: **10000.0**

Activation Source Settings:

- SP1 Activation Source: **Total 1**

Setpoint Trigger & Reset Functions Settings:

- Reset Trigger: **MAKE** (reset to 0.0)
- Reset Destination Register: **Total 1**
- Reset Mode: **I-S+C**
- Reset Constant: **0**
- Remaining Settings: **OFF**

Pulse Output:

- Relay output connected to remote totalizer
Increments electromechanical counting device by 1 count every 10,000 gallons

Example Procedure

The following example procedure shows how to configure totalizer 1 and totalizer 2 as a sub-total grand total totalizer according to the **totalizer configuration settings** described in the Totalizer Settings Example.

All other configuration settings, such as calibration and setpoint, can be applied to the procedures described for each applicable mode throughout this document.

Step 1
Enter the Main Programming Mode

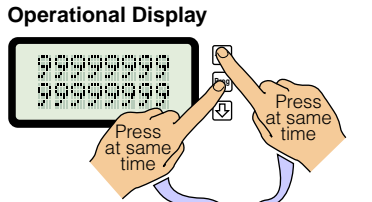

Step 2
Skip the Contrast Mode

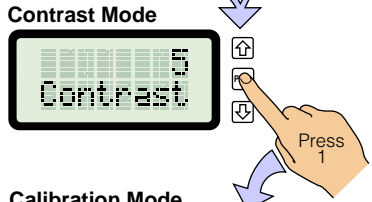

Step 3
Skip the Calibration Mode

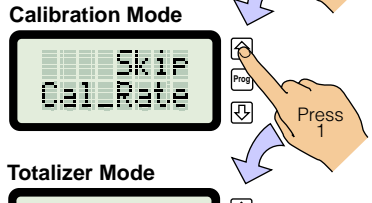

Step 4
Enter the Totalizer Mode

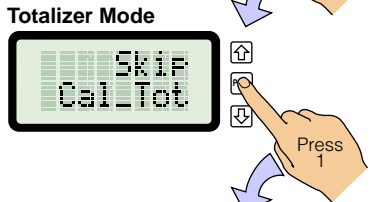

Step 5
Select totalizer 1 [tot_1]

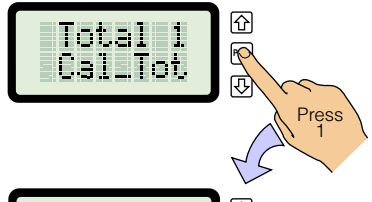

Step 6
Set the required input rate

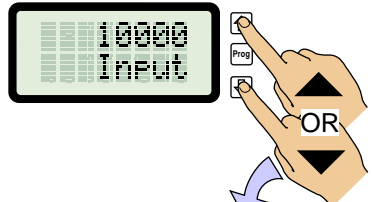

Step 7
Save the input rate and enter the running time mode

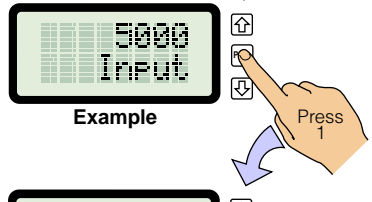

Step 8
Select the required running time setting

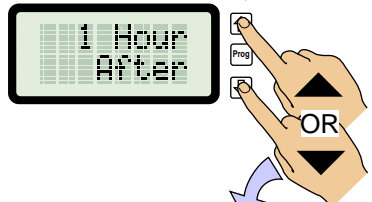

Step 9
Save the running time setting and enter the total required mode

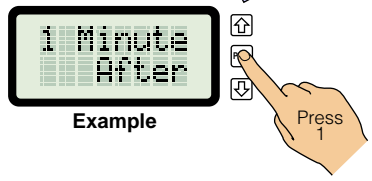

From Step 9

Step 10
Set the required total

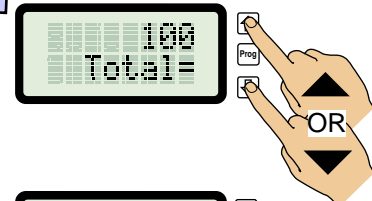

Step 11
Save the total setting and enter the cutoff mode

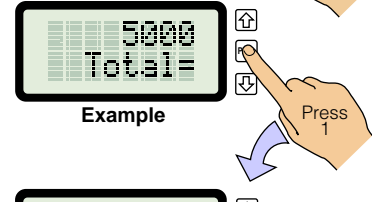

Step 12
Adjust to the required cutoff setting

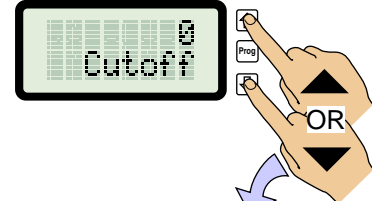

Step 13
Save the cutoff setting and enter the rollover mode

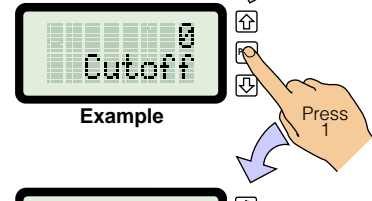

Step 14
Select the required rollover setting

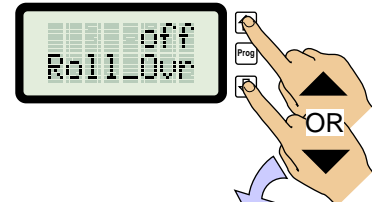

Step 15
Save the rollover setting and return to the beginning of the Totalizer Mode

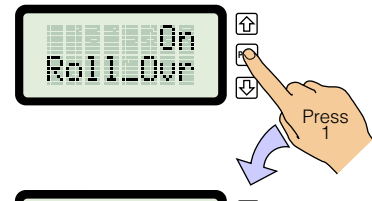

Step 16
Press the [Prog] button twice to enter the Totalizer Mode and go to totalizer 2

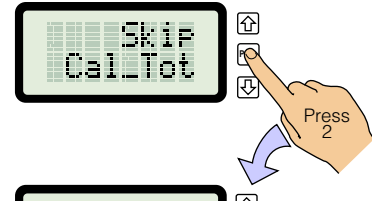

Step 17
Enter totalizer 2

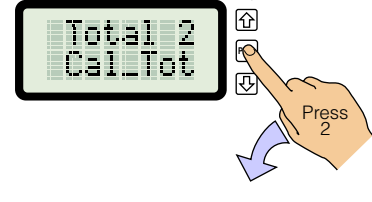

Step 18
Set the required input rate

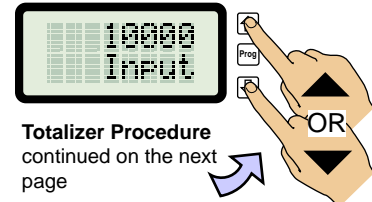

Totalizer Mode continued

From Step 18

Step 19

Save the **input rate** and enter the **running time** mode

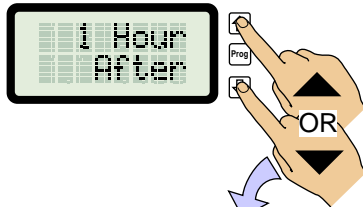
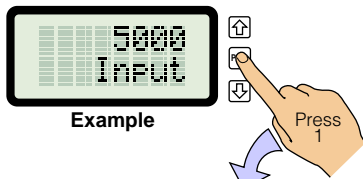

Step 20

Select the **running time** setting

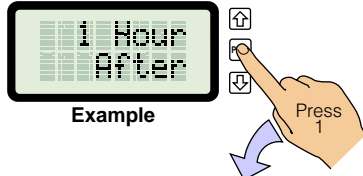

Step 21

Save the **running time** setting and enter the **total required** mode

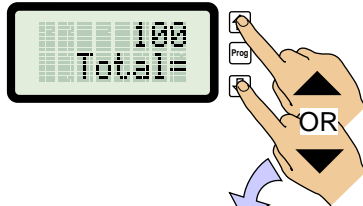

Step 22

Set the required **total**

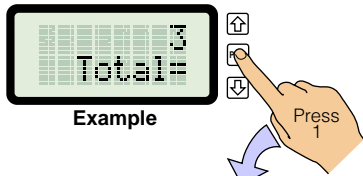

Step 23

Save the **total** setting and enter the **cutoff** mode

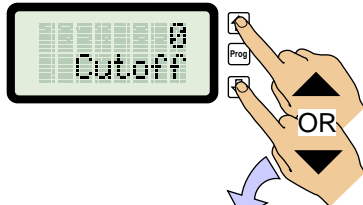

Step 24

Adjust to the required **cutoff** setting

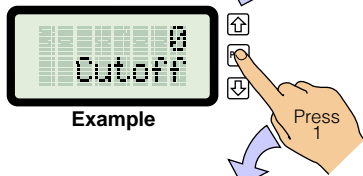

Step 25

Save the **cutoff** setting and enter the mode

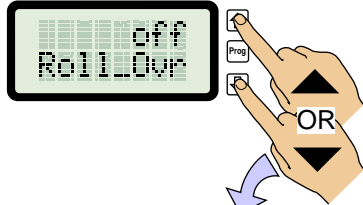

Step 26

Select the **rollover** setting

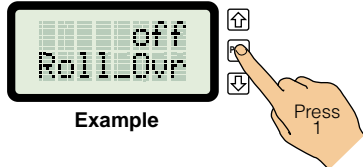

Step 27

Save the **rollover** setting and return to the beginning of the Totalizer Mode

From Step 27

Step 28

Leave the Totalizer Mode



Signal Filtering Mode

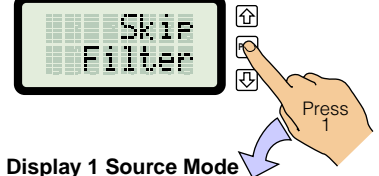

Step 29

Skip the Signal Filtering Mode

Display 1 Source Mode

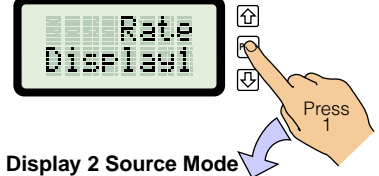

Step 30

Skip the Display 1 Source Mode

Display 2 Source Mode

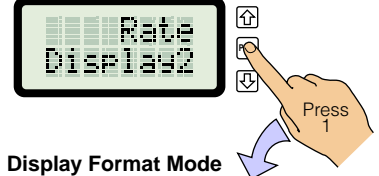

Step 31

Skip the Display 2 Source Mode

Display Format Mode

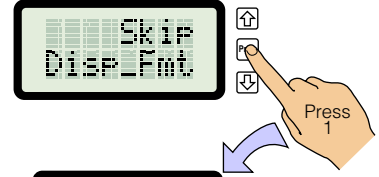

Step 32

Skip the Display Format Mode to return to the operational display

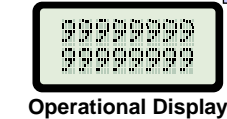

To Step 28

Main Programming Mode

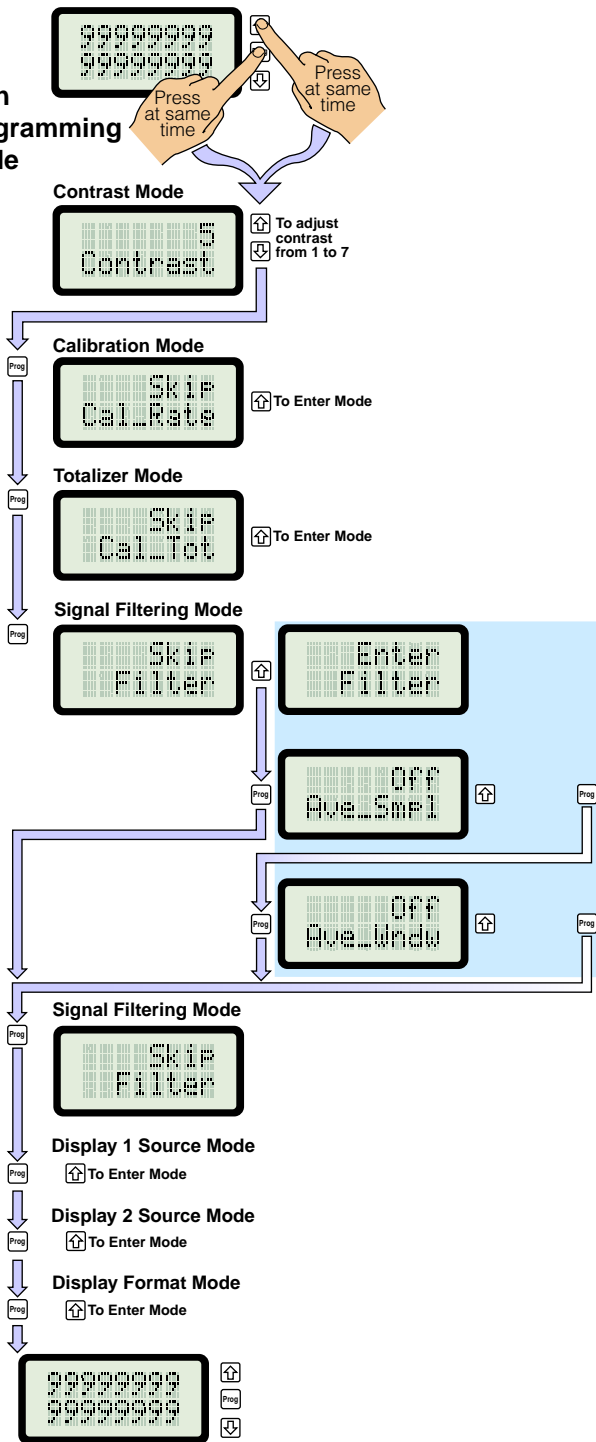

Windowed averaging allows you to average a selected number of input signal samples within a selectable averaging window. This allows you the benefit of a stable signal, with fast response to change when required.

The number of input signal samples to average over is selected in the [Ave_Smpl] menu. The size of the averaging window in input signal display counts is selected in the [Ave_Wndw] menu.

While the signal is being monitored by the controller, the averaging window tracks the input signal, looks at the samples, and when it locates a group of samples within the size of the window, averaging takes place. As each new sample comes into the controller, the last sample in the group is dropped off. Provided the sample group remains within the averaging window, the controller constantly averages the sample group.

If a sample moves out of the averaging window, the controller responds quickly to the change by displaying the non-averaged signal value. When the signal stabilizes, a new averaging window is established around a sample group and averaging resumes.

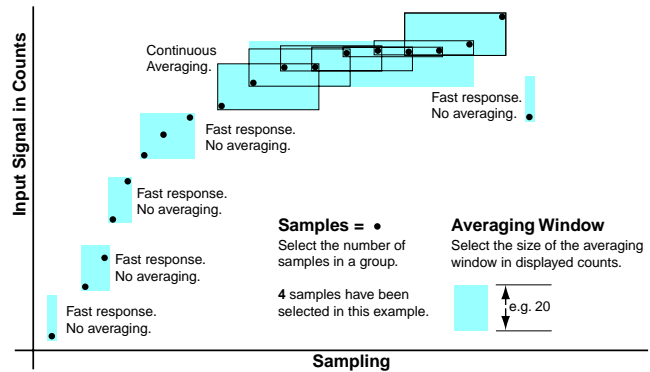

Example Procedure

The example procedure on Page 17 shows how to configure channel 1 (CH1) with an averaging sample rate of 10 counts and an averaging window of 1000 counts.

Signal Filtering Mode continued

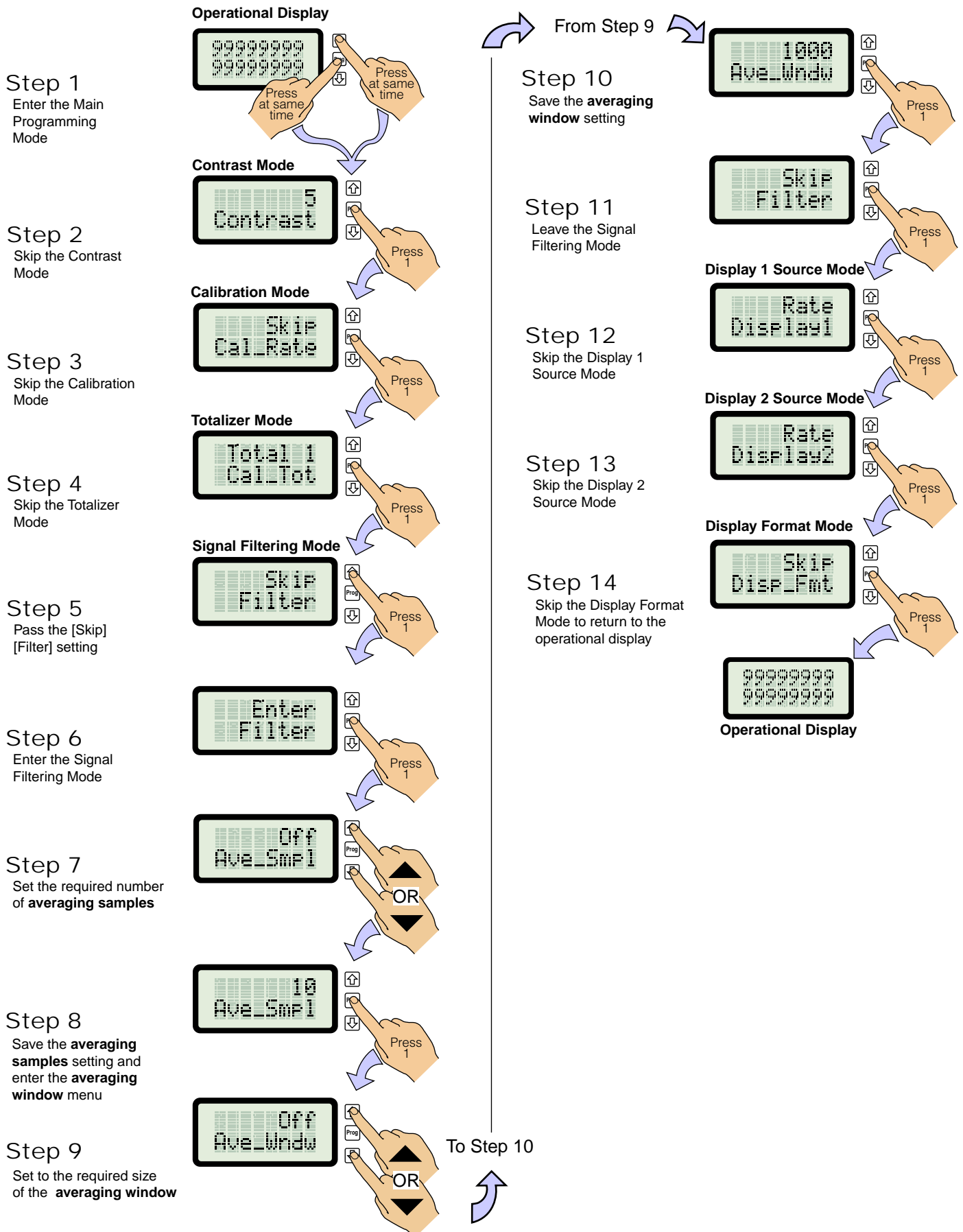

Display 1 Source Mode

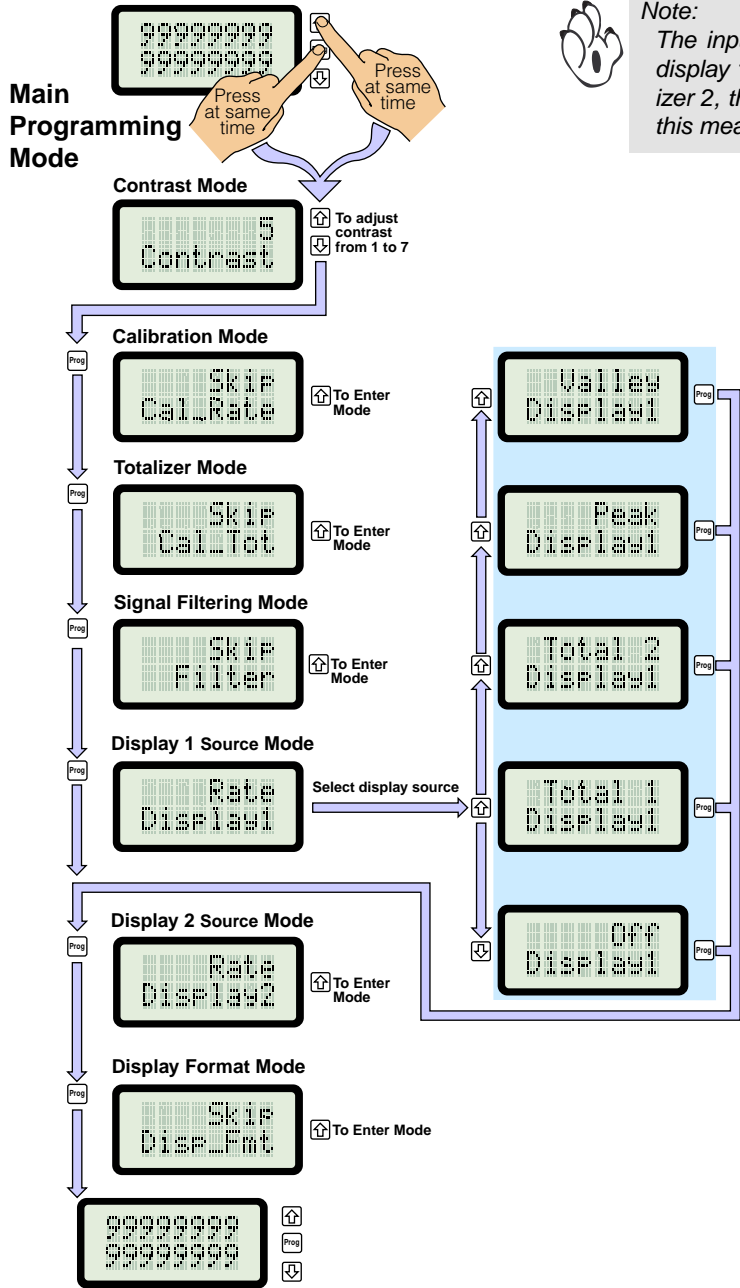

Note:

The input signal (Rate) is normally selected as the data source for display 1. Display 1 can be used to display the sum of totalizer 1, totalizer 2, the peak or valley reading, or even set to Off. When set to Off, this means the display only displays a message during programming.

The **display 1 source mode** allows you to select the source for the **top** display. This means that any one of the following can be displayed on the top display. The rest can be viewed in the view mode by simply pressing the or button:



This is the input signal from the sensor and is displayed as [Rate] in the view mode.



This is totalizer 1 and is displayed as [Total 1] in the view mode.



This is totalizer 2 and is displayed as [Total 2] in the view mode.



This is the maximum input signal reading that the meter has recorded since it was last switched on or reset and is displayed as [Peak] in the view mode.



This is the valley or minimum input signal reading that the meter has recorded since it was last switched on or reset and is displayed as [Valley] in the view mode.

Example Procedure

The example procedure on Page 19 shows how to select the input signal [Rate] as the displayed reading on the top display (display 1).

Display 1 Source Mode continued

Step 1
Enter the Main Programming Mode

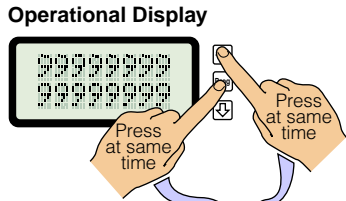

Step 2
Skip the Contrast Mode

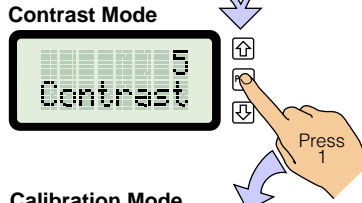

Step 3
Skip the Calibration Mode

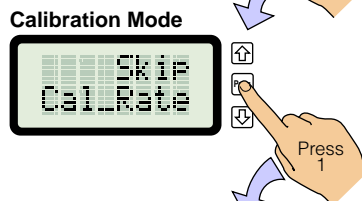

Step 4
Skip the Signal Filtering Mode

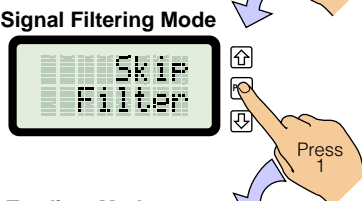

Step 5
Skip the Totalizer Mode

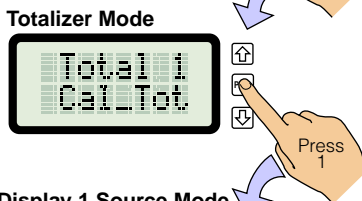

Step 6
Enter the Display 1 Source Mode and select the required data source for display 1

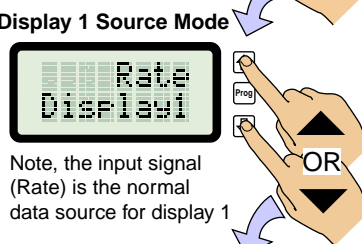

Step 7
Save the Display 1 source setting

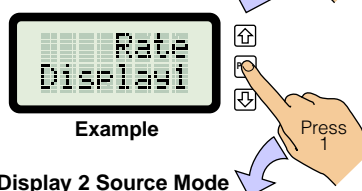

Step 8
Skip the Display 2 Source Mode

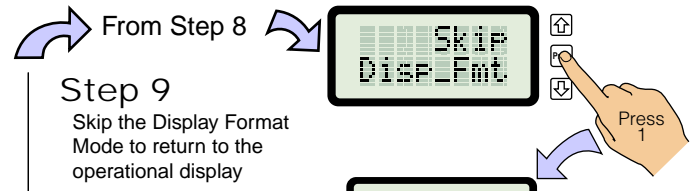
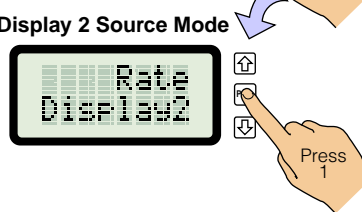

Step 9
Skip the Display Format Mode to return to the operational display

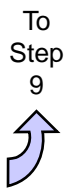
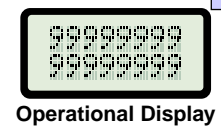

Display 2 Source Mode

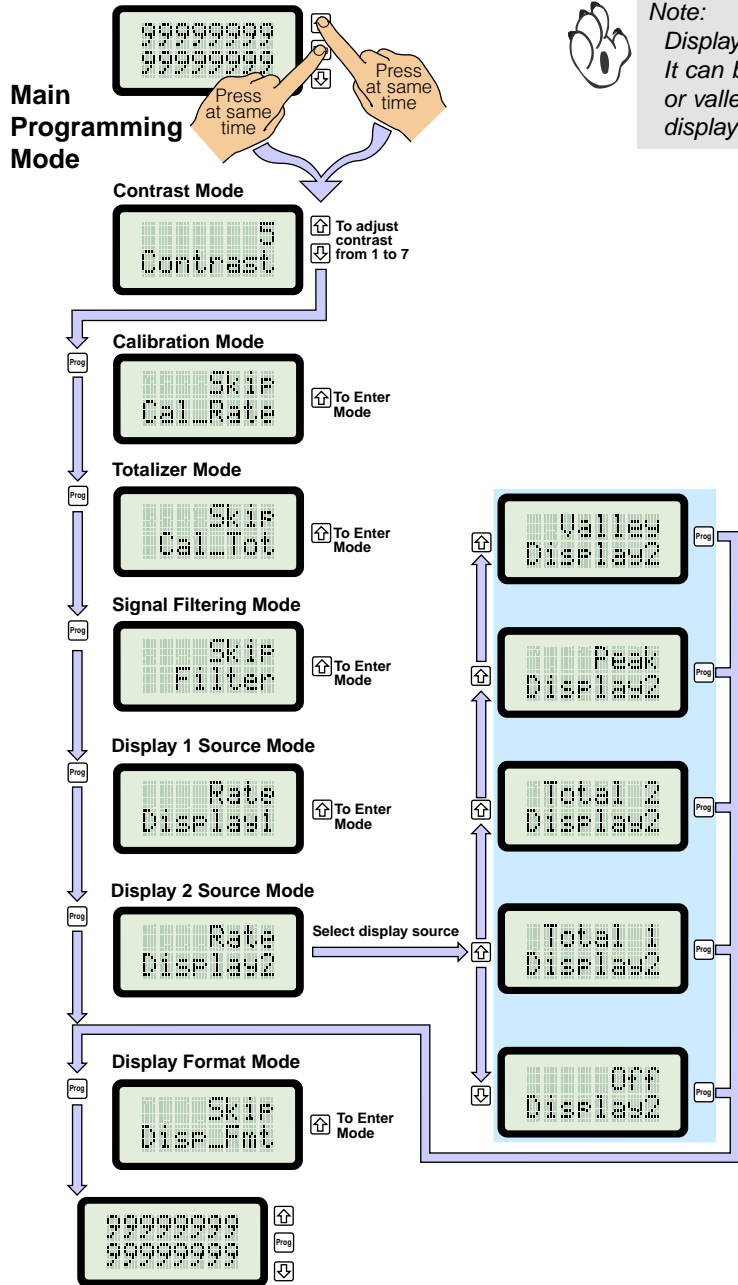

Note:
 Display 2 is normally used to display data other than the input signal. It can be used to display the sum of totalizer 1, totalizer 2, the peak or valley reading, or even set to Off. When set to Off, this means the display only displays a message during programming.

The **display 2 source mode** allows you to select the source for the **bottom** display. This means that any one of the following can be displayed on the **bottom** display. The rest can be viewed in the view mode by simply pressing the or button:

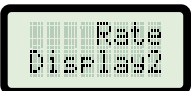

This is the input signal from the sensor and is displayed as [Rate] in the view mode.



This is totalizer 1 and is displayed as [Total 1] in the view mode.



This is totalizer 2 and is displayed as [Total 2] in the view mode.



This is the maximum input signal reading that the meter has recorded since it was last switched on or reset and is displayed as [Peak] in the view mode.



This is the valley or minimum input signal reading that the meter has recorded since it was last switched on or reset and is displayed as [Valley] in the view mode.

Example Procedure

The example procedure on Page ?? shows how to select the peak reading [Peak] as the displayed reading on the bottom display (display 2).

Step 1

Enter the Main Programming Mode

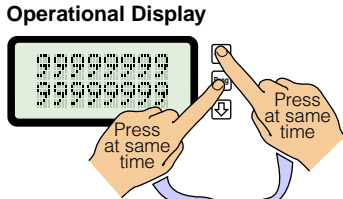

Step 2

Skip the Contrast Mode

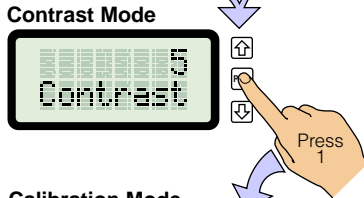

Step 3

Skip the Calibration Mode

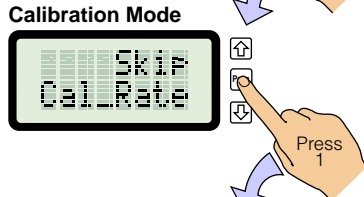

Step 4

Skip the Signal Filtering Mode

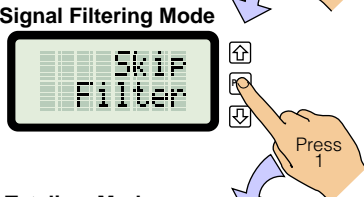

Step 5

Skip the Totalizer Mode

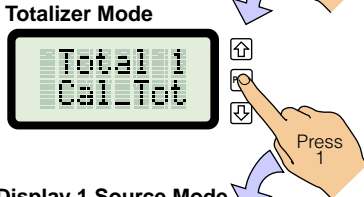

Step 6

Skip the Display 1 Source Mode

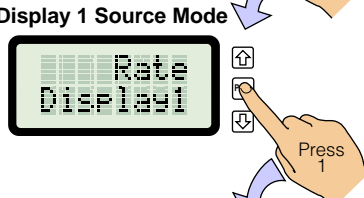

Step 7

Enter the Display 2 Source Mode and select the required data source for display 2

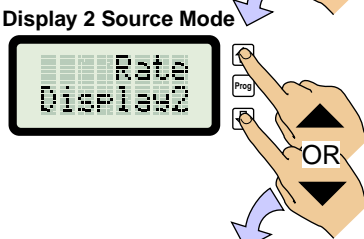

Step 8

Save the Display 2 source setting

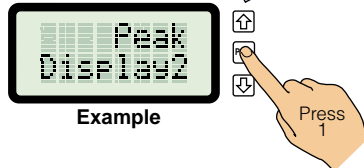

From Step 8

Step 9

Skip the Display Format Mode to return to the operational display

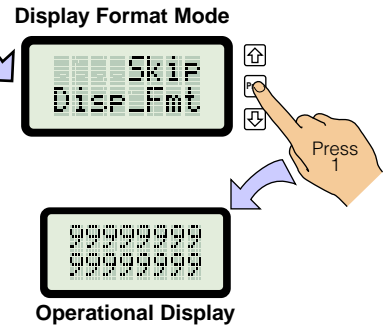

To Step 9

Display Format Mode

The **display format mode** allows you to format how the input signal (rate), totalizer 1 (total 1), and totalizer 2 (total 2) are displayed when shown on the operational or recall displays.

A decimal point can be inserted to adjust the resolution and, if required, a last digit descriptor displayed using one of the 79 text characters available.

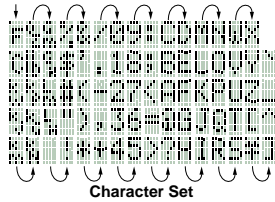

Main Programming Mode

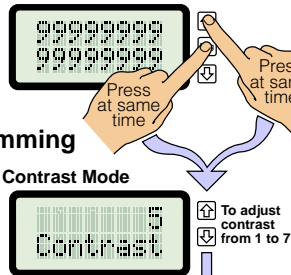

- Calibration Mode
To Enter Mode
- Totalizer Mode
To Enter Mode
- Signal Filtering Mode
To Enter Mode
- Display 1 Source Mode
To Enter Mode
- Display 2 Source Mode
To Enter Mode
- Display Format Mode

Decimal Point Menu

The decimal point menu allows you to set the resolution of the display for the input signal, totalizer 1, and totalizer 2 in individual sub-menus. A decimal point can be placed after any digit or not shown at all. Setting the decimal point can produce the following display resolutions:

- One (No decimal point).
- Tenths.
- Hundredths.
- Thousandths.
- Ten thousandths.
- One hundred thousandths.
- Millionths.

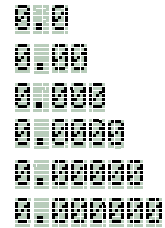

Last Digit Descriptor Menu

The last digit descriptor menu [Text] allows you to select one of 79 available characters as a descriptor in the last digit. See character list opposite.

For example, if the meter was measuring a temperature, the display could be configured to display the reading with a C or an F in the last digit for °C or °F.

Note:

When using a last digit descriptor, the meter effectively becomes a 7-digit display with a minimum reading of -900000 and a maximum reading of 9900000, instead of an 8-digit display reading from -9900000 up to 9900000.

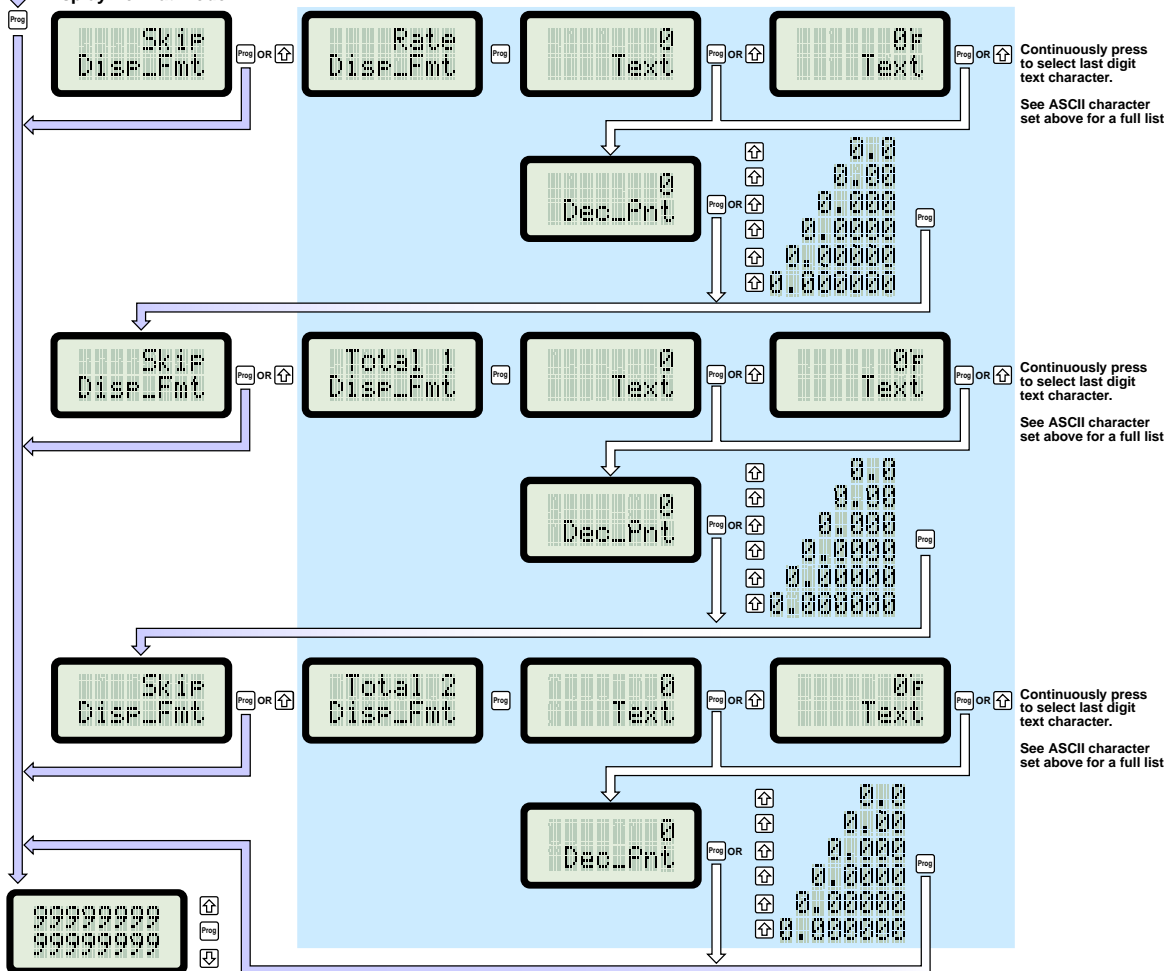

Example Procedure

The following example procedure shows how to configure the last digit character as “F” for fahrenheit (°F) and set the input signal display resolution to tenths.

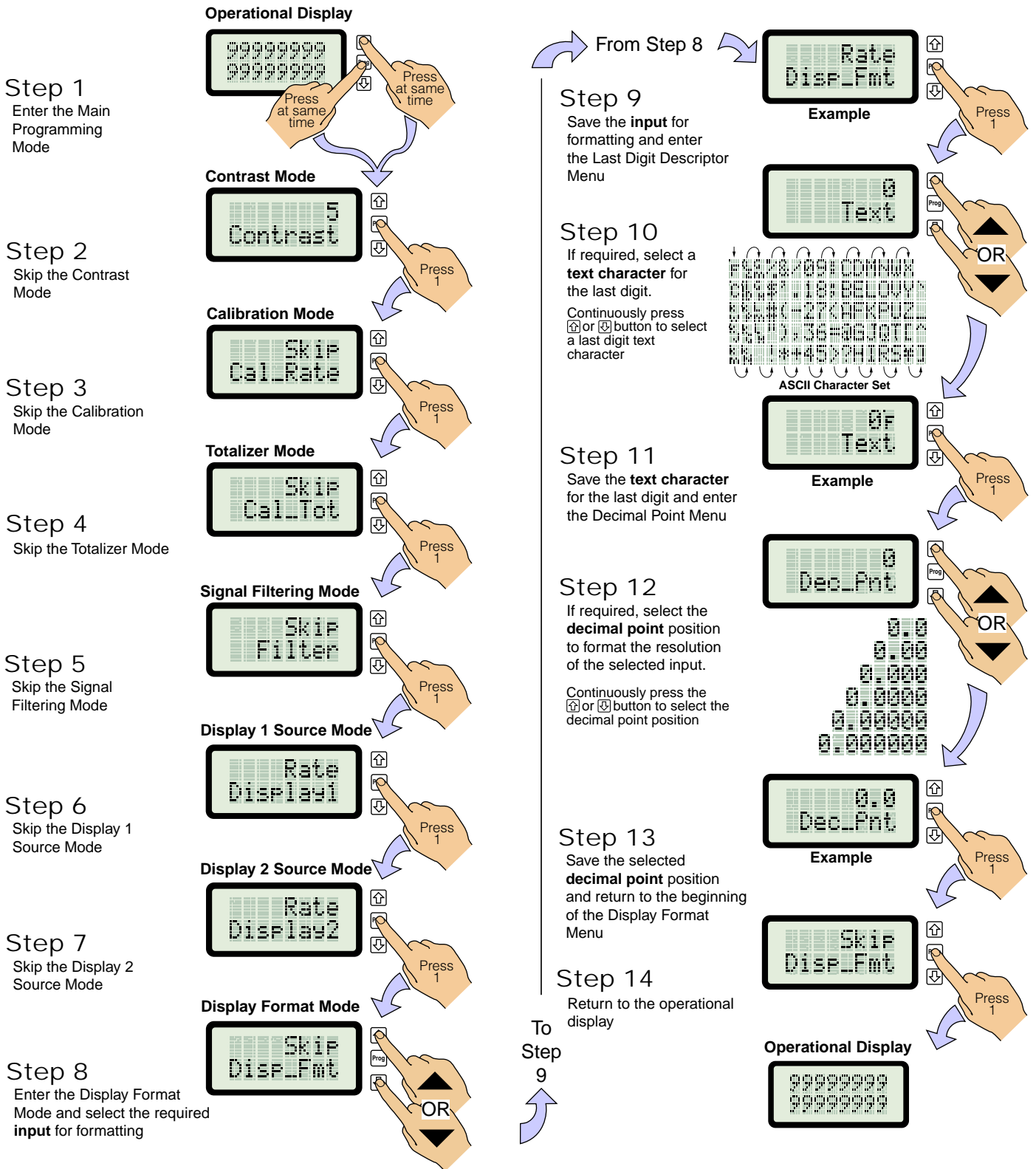

Note:
If a last digit descriptor is used the meter is effectively turned into a 7-digit display. The resolution settings are automatically adjusted by the meter to remain as set (for example: if set to tenths, the decimal point is moved one digit to the left to maintain its original position).

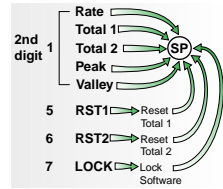
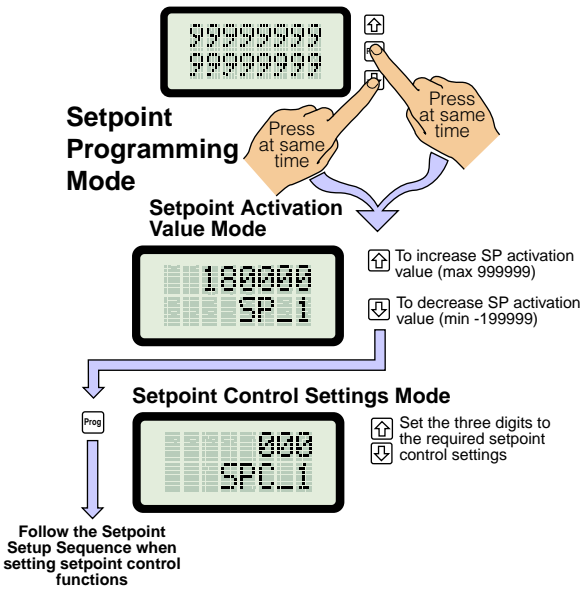

Setpoint Activation Source

The setpoint can activate from the input signal (rate), totalizer 1, totalizer 2, the peak reading, or the valley reading.

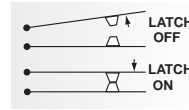

Setpoint Latching

The setpoint can be programmed in various relay latching modes.

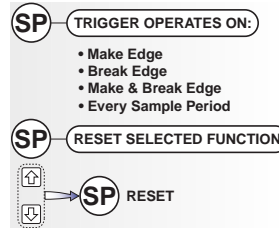

Setpoint Reset & Trigger

The setpoint can be programmed to reset or trigger from the input signal (rate), totalizer 1, totalizer 2, the peak reading, or the valley reading. It can also be programmed to reset manually by pressing the the and buttons at the same time while in the operational display.

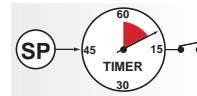

Setpoint Timer Modes

The setpoint can be programmed to operate the relay in one of the following seven resident timer modes:

Normal Mode Timer

Single actuation, delay-on-make (DOM) and delay-on-break (DOB).

Normally OFF/Pulsed ON Timers

Repeat ON Mode Timer – multiple actuation, programmable off- and on-time.

Pulse ON Mode Timer – single actuation, programmable DOM and maximum on-time.

1-Shot ON Mode Timer – single actuation, programmable DOM and minimum on-time.

Normally ON/Pulsed OFF Timers

Repeat OFF Mode Timer – multiple actuation, programmable off- and on-time.

Pulse OFF Mode Timer – single actuation, programmable DOB and maximum off-time.

1-Shot OFF Mode Timer – single actuation, programmable DOB and minimum off-time.

All setpoint activation and control settings are selected and configured using the front panel buttons in the **setpoint programming mode**. The meter has one software driven setpoint configured to operate within the total span range of the meter.

The setpoint programming mode is entered by pressing the and buttons at the same time.

Relay Output

The meter contains a 400 V, 210 mA DC solid state relay (SSR).

Setpoint Activation Value

The setpoint activation value can be set within the total span range of the meter.

Setpoint and Relay Control Settings

Setpoint control settings provide access to the following setpoint and relay functions for configuration using the meter's 1st, 2nd, and 3rd digits. These settings allow you to enter and program the various control functions of the setpoint programming mode:

- **1st Digit** – Relay energize functions.
- **2nd Digit** – Setpoint activation source and external switching functions.
- **3rd Digit** – Relay latching modes, hysteresis & deviation modes, setpoint timer modes, and setpoint trigger & reset functions.

Setpoint Functions

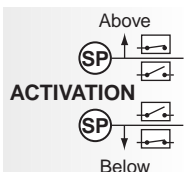

Relay Energize Functions

The setpoint activates at the programmed setpoint value. The relay is programmable to energize above or below the setpoint value.

Setpoint Activation Source

- Input signal (Rate).
- Totalizer 1.
- Totalizer 2.
- Peak.
- Valley.

Setpoint Activation Functions

- Activate ABOVE setpoint.
- Activate BELOW setpoint.
- Hysteresis.
- Deviation.
- Initial Start-up Inhibit.

Setpoint Timer Modes

- **Normal Mode.** Delay-on-make (DOM), delay-on-break (DOB) settings.
- **Repeat ON Mode.** Programmable **on** and **off time** settings.
- **Pulse ON Mode.** Programmable **DOM** and **on time** settings.
- **1-Shot ON Mode.** Programmable **DOM** and **minimum on time** settings.
- **Repeat OFF Mode.** Programmable **off** and **on time** settings.
- **Pulse OFF Mode.** Programmable **off time** and **DOB**.
- **1-Shot OFF Mode.** Programmable **minimum off time** and **DOB** settings.

Setpoints & Relays

Setpoint Activation Results

- Flash display.
- Turn relay ON.
- Turn relay OFF.
- Latch relay ON.
- Latch relay OFF.
- Count setpoint activations.
- Reset specific functions.
- Increment specific functions.

Setpoint Timer Results

- Single and multiple actuation, normally OFF / pulsed ON or normally ON / pulsed OFF modes.
- 0.1 second resolution in all timer modes.
- Delay-on-make, Delay-on-break (Normal timer).
- Turn relay ON/OFF/ON/OFF (Repeat timer).
- Turn relay OFF/ON/OFF/ON (-Repeat timer).
- Pulse ON for guaranteed on-time (Pulse timer).
- Pulse OFF for guaranteed off-time (-Pulse timer).
- Stay ON for guaranteed minimum on-time (1Shot timer).
- Stay OFF for guaranteed minimum off-time (-1Shot timer).

The following diagram shows the three digit control function settings for the setpoint and relay.

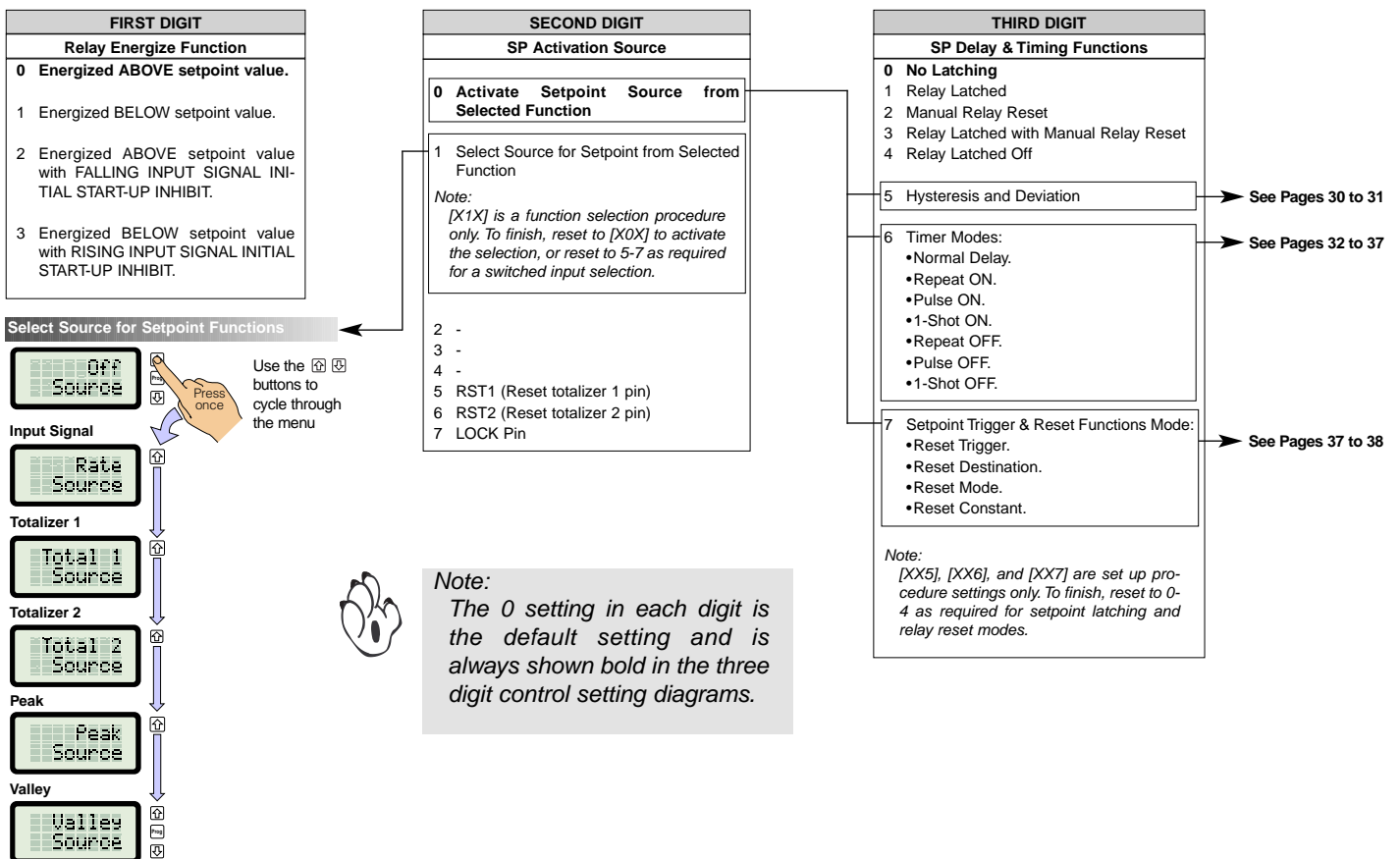

1st Digit Settings – Relay Energize Functions

The relay energize functions are configured as part of the final setpoint settings once all other modes have been configured. See Page 39 Setpoint Setup Sequence.

The setpoint activates at the setpoint activation value. The 1st digit allows you to program the setpoint relay to energize **above** or **below** the setpoint value.

The functionality of the **relay energize functions** are further enhanced with an initial start-up inhibit mode selected in the 1st digit, and selecting either **hysteresis** or **deviation** with the 3rd digit set to [XX5].

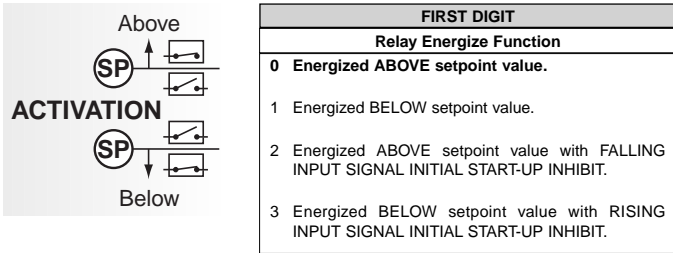

Initial Start-up Inhibit

The setpoint can also be programmed to energize the relay with or without initial start-up inhibit.

On switch-on when set to either [0XX] or [1XX], initial start-up inhibit prevents the relay from energizing on the first setpoint activation cycle. When set to [2XX] initial start-up inhibit only functions during a falling input signal. When set to [3XX] initial start-up inhibit only functions during a rising input signal. The signal must activate then deactivate the setpoint, and only when the setpoint activates for the second time does the relay energize.

Example 1 shows the relay energize functions with and without initial start-up inhibit.

Hysteresis Selected

[0X5] Relay Energizes Above SP Value

With 0 selected in the 1st digit, the relay energizes at or above the setpoint value plus the hysteresis counts, then de-energizes below the setpoint value minus the hysteresis counts.

[1X5] Relay Energizes Below SP Value

With 1 selected in the 1st digit, the relay energizes below the setpoint value minus the hysteresis counts, then de-energizes at or above the setpoint value plus the hysteresis counts.

[2X5] Relay Energizes Above SP Value With Initial Start-up Inhibit

With 2 selected in the 1st digit, the relay energizes at or above the setpoint value plus the hysteresis counts, then de-energizes below the setpoint value minus the hysteresis counts. With falling input signal initial start-up inhibit, the signal activates then de-activates the setpoint, and only when the setpoint activates for the second time on a rising signal does the relay energize.

[3X5] Relay Energizes Below SP Value With Initial Start-up Inhibit

With 3 selected in the 1st digit, the relay energizes below the setpoint value minus the hysteresis counts, then de-energizes at or above the setpoint value plus the hysteresis counts. With rising input signal initial start-up inhibit, the signal activates then de-activates the setpoint, and only when the setpoint activates for the second time on a falling signal does the relay energize.

Example 2 shows the relay energize functions with hysteresis applied with and without initial start-up inhibit.

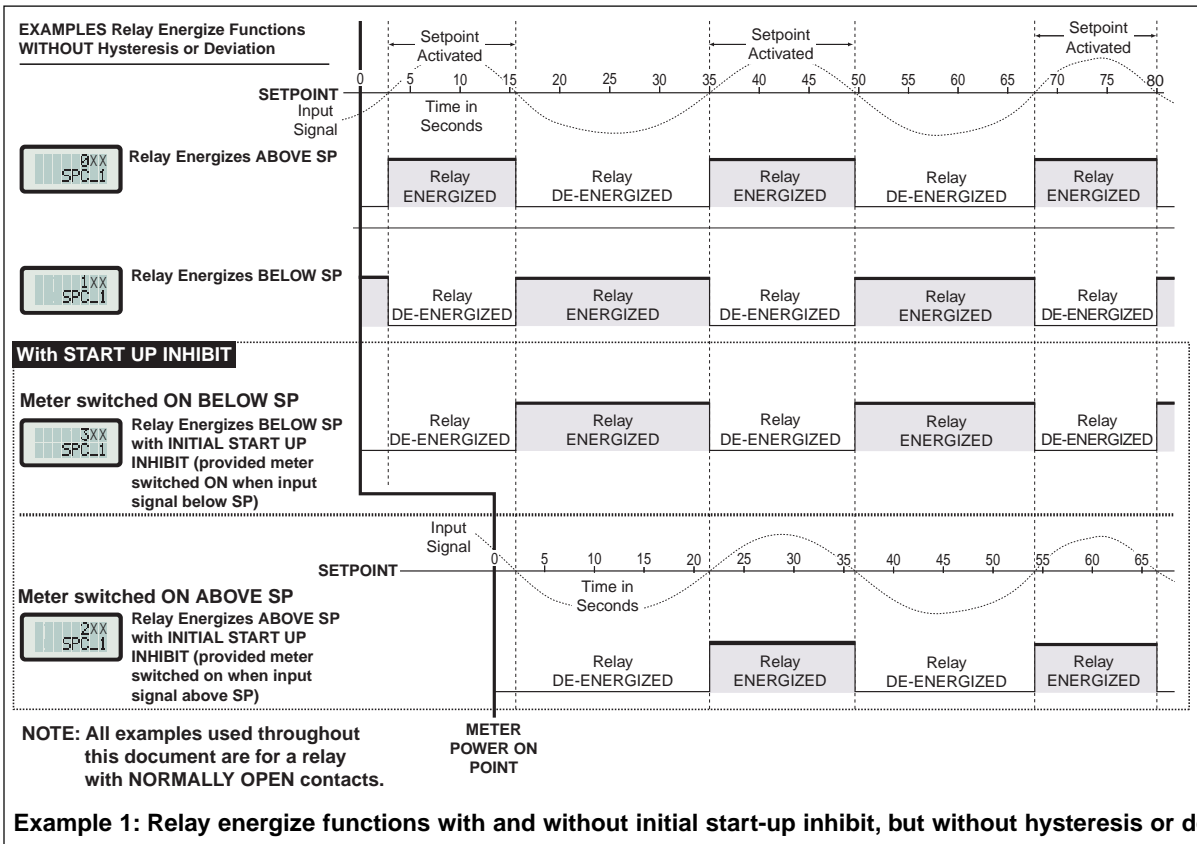

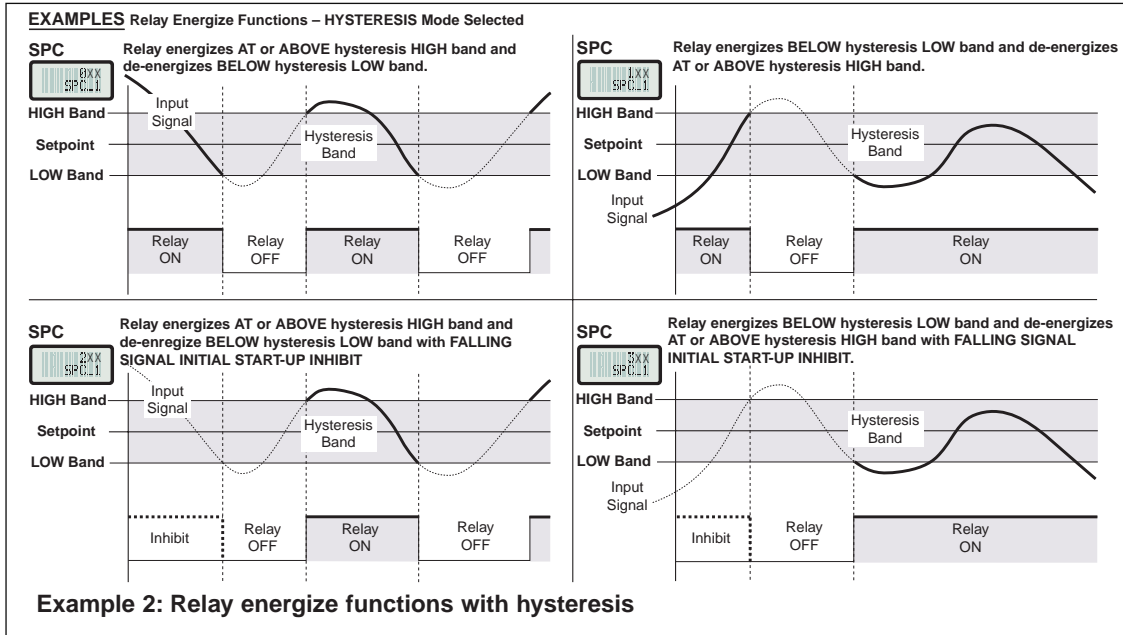

Deviation Selected

[0X5] Relay Energizes Above SP Value

With 0 selected in the 1st digit, the relay energizes inside the deviation band (setpoint ± deviation counts), then de-energizes outside the deviation band (setpoint ± deviation counts).

[1X5] Relay Energizes Below SP Value

With 1 selected in the 1st digit, the relay energizes outside the deviation band (setpoint ± deviation counts), then de-energizes inside the deviation band (setpoint ± deviation counts).

[2X5] Relay Energizes Above SP Value With Initial Start-up Inhibit

With 2 selected in the 1st digit, the relay energizes inside the deviation band (setpoint ± deviation counts), then de-energizes outside the deviation band (setpoint ± deviation counts).

With falling input signal initial start-up inhibit, the signal activates then de-activates the setpoint, and only when the setpoint activates for the second time, when the signal comes into the deviation band, does the relay energize.

[3X5] Relay Energizes Below SP Value With Initial Start-up Inhibit

With 3 selected in the 1st digit, the relay energizes outside the deviation band (setpoint ± deviation counts), then de-energizes inside the deviation band (setpoint ± deviation counts). With rising input signal initial start-up inhibit, the signal activates then de-activates the setpoint, and only when the setpoint activates for the second time, when the signal goes outside the deviation band, does the relay energize.

Example 3 shows the relay energize functions with deviation applied with and without initial start-up inhibit.

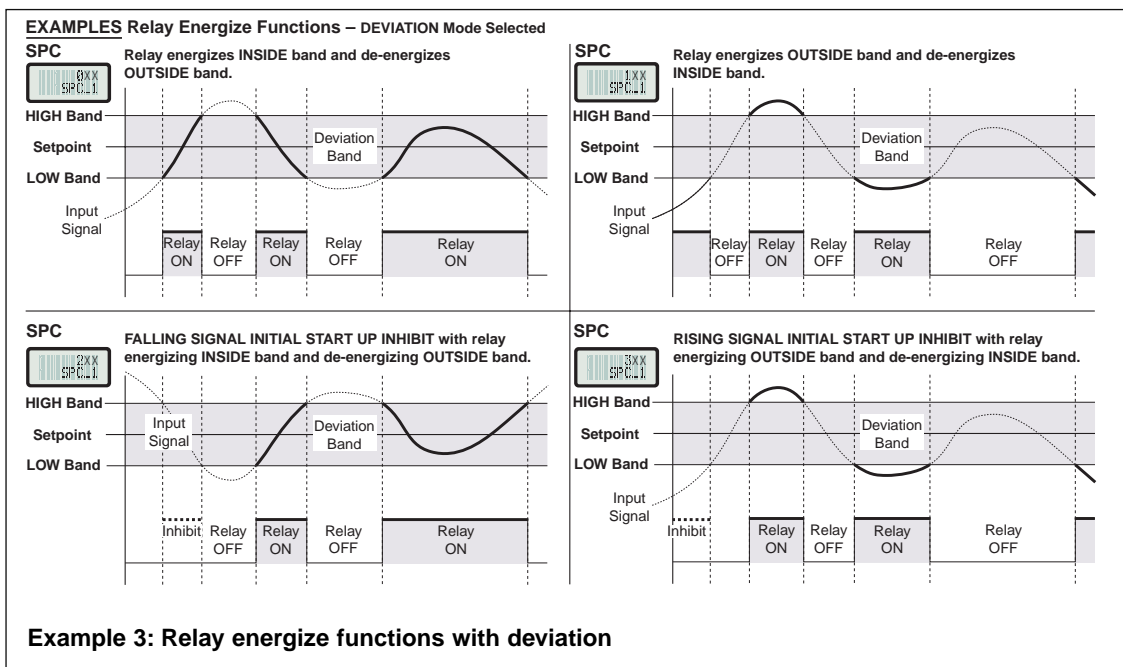

2nd Digit Settings

The 2nd digit of the setpoint and relay control mode allows you to configure the setpoint activation source. The setpoint can be activated from any of the setpoint activation functions available when the 2nd digit is set to 1, or from one of the listed external switching functions: 2nd digit set to 5, 6, or 7.

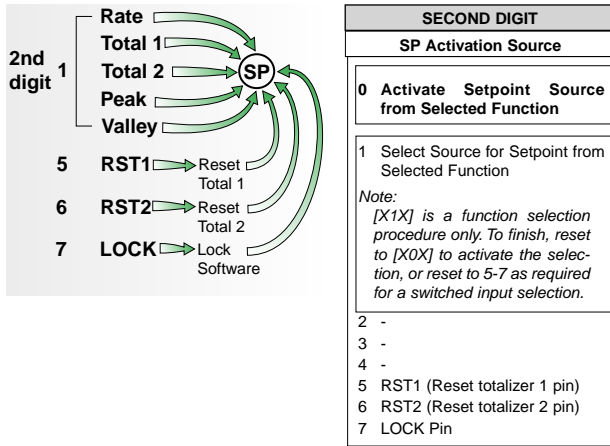

Setpoint Activation Source Setup Mode

The **setpoint activation source setup mode** allows you to select a function to activate the setpoint. This is done by selecting 1 in the 2nd digit and then selecting one of the following functions:

- Input signal (rate).
- Totalizer 1 (total 1).
- Totalizer 2 (total 2).
- The peak reading (peak).
- The valley reading (valley).

When the activation source has been selected from the activation functions, reset the **2nd** digit back to 0. This allows you to leave the SP activation source mode and ensures the selected activation function triggers the setpoint.

External Switching Functions

Instead of activating the setpoint using one of the activation functions available by selecting 1 in the 2nd digit, one of the following external switching functions can also be used to trigger the setpoint:

- RST1 Pin, set to 5 in the 2nd digit.
- RST2 Pin, set to 6 in the 2nd digit.
- LOCK Pin, set to 7 in the 2nd digit.

If selected, the switching function triggers the setpoint and also performs its designated switching function when connected to ground. The switching function overrides any selection you may have made in the setpoint activation source setup mode [X1X].

Even if not selected to activate the setpoint, the external switching function pins operate as follows when connected to ground (GND) using a switch:

- RST1 Pin. Allows you to reset totalizer 1.
- RST2 Pin. Allows you to reset totalizer 2.
- LOCK Pin. Allows you to view the meter's programmed parameters but not make any changes to them.

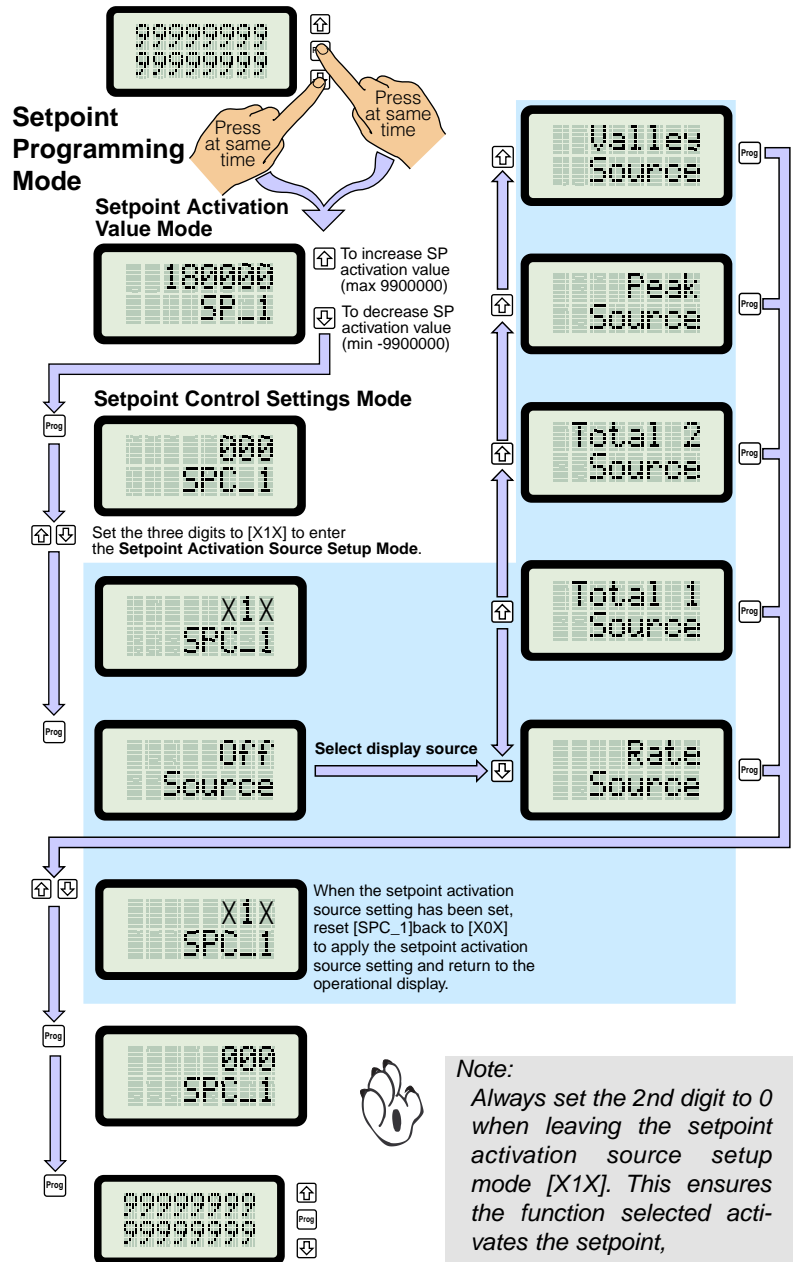

Note:
Always set the 2nd digit to 0 when leaving the setpoint activation source setup mode [X1X]. This ensures the function selected activates the setpoint.

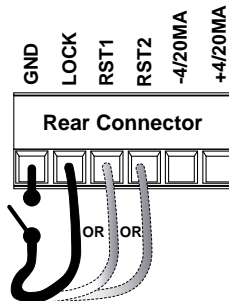

3rd Digit Settings

The 3rd digit of the setpoint and relay control mode allows you to configure the following:

- Relay latching and manual reset functions.
- Hysteresis or deviation settings.
- Setpoint timer modes.
- Setpoint trigger and reset functions.

THIRD DIGIT	
SP Delay & Timing Functions	
0	No Latching
1	Relay Latched
2	Manual Relay Reset
3	Relay Latched with Manual Relay Reset
4	Relay Latched Off
5 Hysteresis and Deviation Mode	
6 Timer Modes:	
<ul style="list-style-type: none"> • Normal Delay. • Repeat ON. • Pulse ON. • 1-Shot ON. • Repeat OFF. • Pulse OFF. • 1-Shot OFF. 	
7 Setpoint Trigger & Reset Mode:	
<ul style="list-style-type: none"> • Reset Trigger. • Reset Destination. • Reset Mode. • Reset Constant. 	
<p>Note: [XX5], [XX6], and [XX7] are set up procedure settings only. To finish, reset to 0-4 as required for setpoint latching and relay reset modes.</p>	

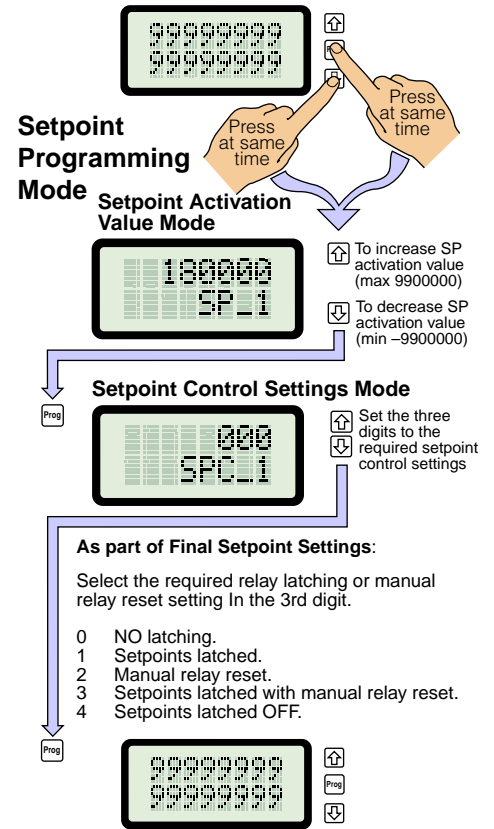

Relay Latching & Manual Relay Reset

The relay latching and relay reset modes are configured as part of the final setpoint settings once all other modes have been configured.

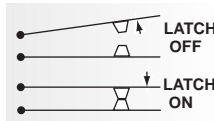

See Page 39.

The 3rd digit allows you to configure the latching functionality of the setpoints and relay.

Selecting [XX0] to [XX4] allows you to program the setpoint for one of five relay latching and manual reset modes.

[XX0] No Latching

Selecting [XX0] means that no latching is applied to the setpoints. See Example – No Latching for an example.

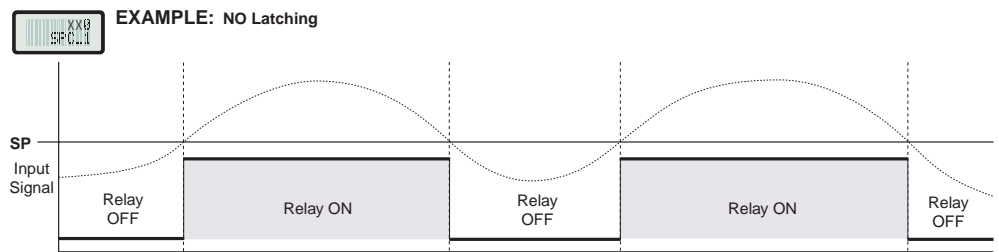

Example – NO Latching

[XX1] Setpoint Latching

Selecting [XX1] means that latching is applied to the setpoints. See Example – Setpoint Latching for an example.

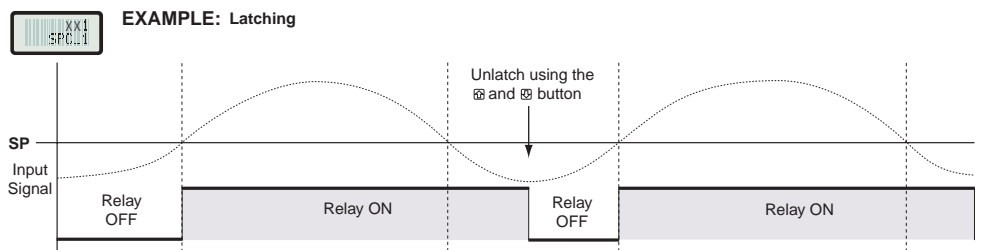

Example – Setpoint Latching

[XX2] Manual Relay Reset

Selecting [XX2] means that the relay can be de-energized (reset) manually by the operator. The relay does not energize again until the setpoint reactivates.

Pressing the and buttons on the meter's front panel at the same time manually resets the relay setpoint by the operator. Or it can be reset from a remote switch (Code 9 set to [X7X] or [XX7]).

See *Example – Manual Relay Reset* for an example.

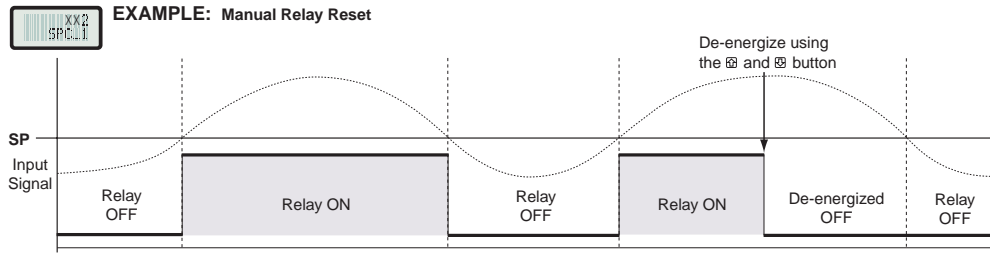

Example – Manual Relay Reset

[XX3] Setpoint Latched with Manual Relay Reset

Selecting [XX3] means that setpoint latching is applied and the relay can be de-energized (reset) manually by the operator. The relay does not energize again until the next setpoint activation.

See *Example – Latching & Manual Relay Reset* for an example.

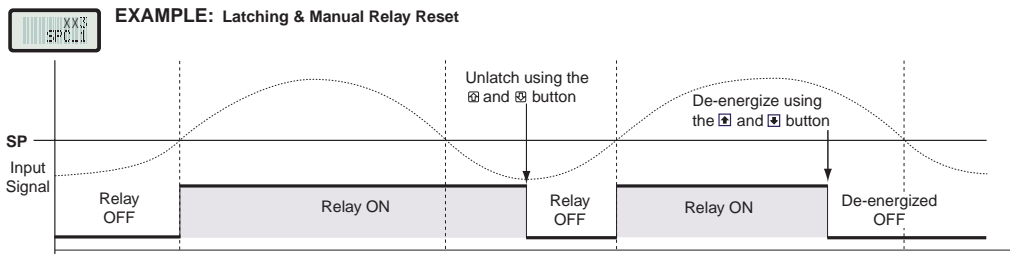

Example – Latching & Manual Relay Reset

[XX4] Setpoint Latched OFF

Selecting [XX4] means that latching is applied to the setpoint but in the latched OFF mode.

See *Example – Latched Off for an example.*

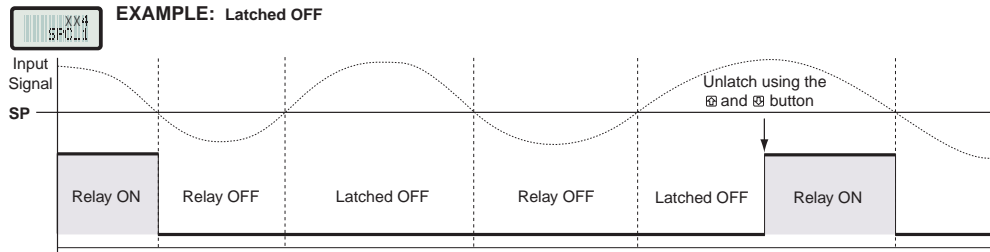

Example – Latched OFF

Hysteresis & Deviation Settings

Hysteresis

The setpoint can be programmed to energize the relay in the hysteresis mode, with or without initial start-up inhibit.

Hysteresis (deadband) is the programmable band above and below the setpoint value that determines when and for how long the relay is energized or de-energized. The setpoint can be programmed to energize the relay above or below the setpoint value.

The hysteresis setting can be any value between 0 and 65535 counts. The number of counts selected act both positively and negatively on the setpoint, forming a hysteresis band around the setpoint.

For example, if the setpoint setting is 500 counts and the hysteresis setting is 10 counts, the hysteresis band around the setpoint setting is 20 counts, starting at 490 counts and ending at 510 counts.

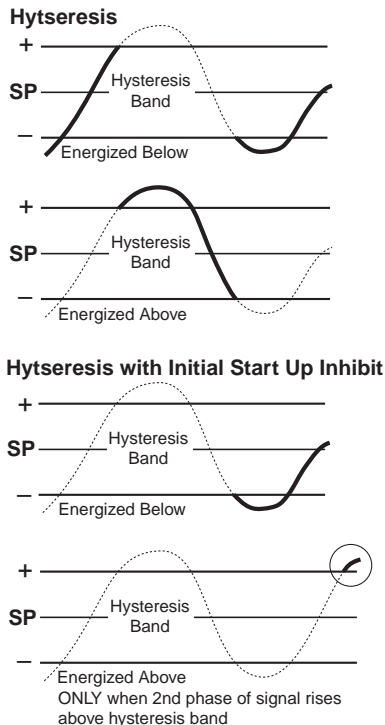

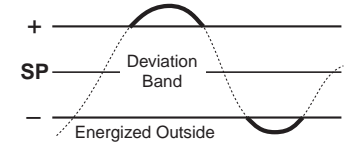
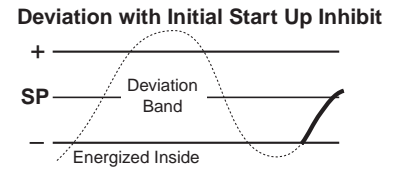
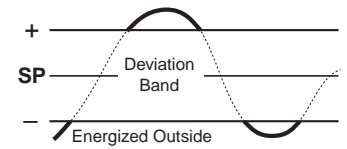
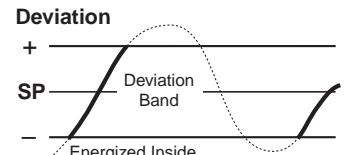
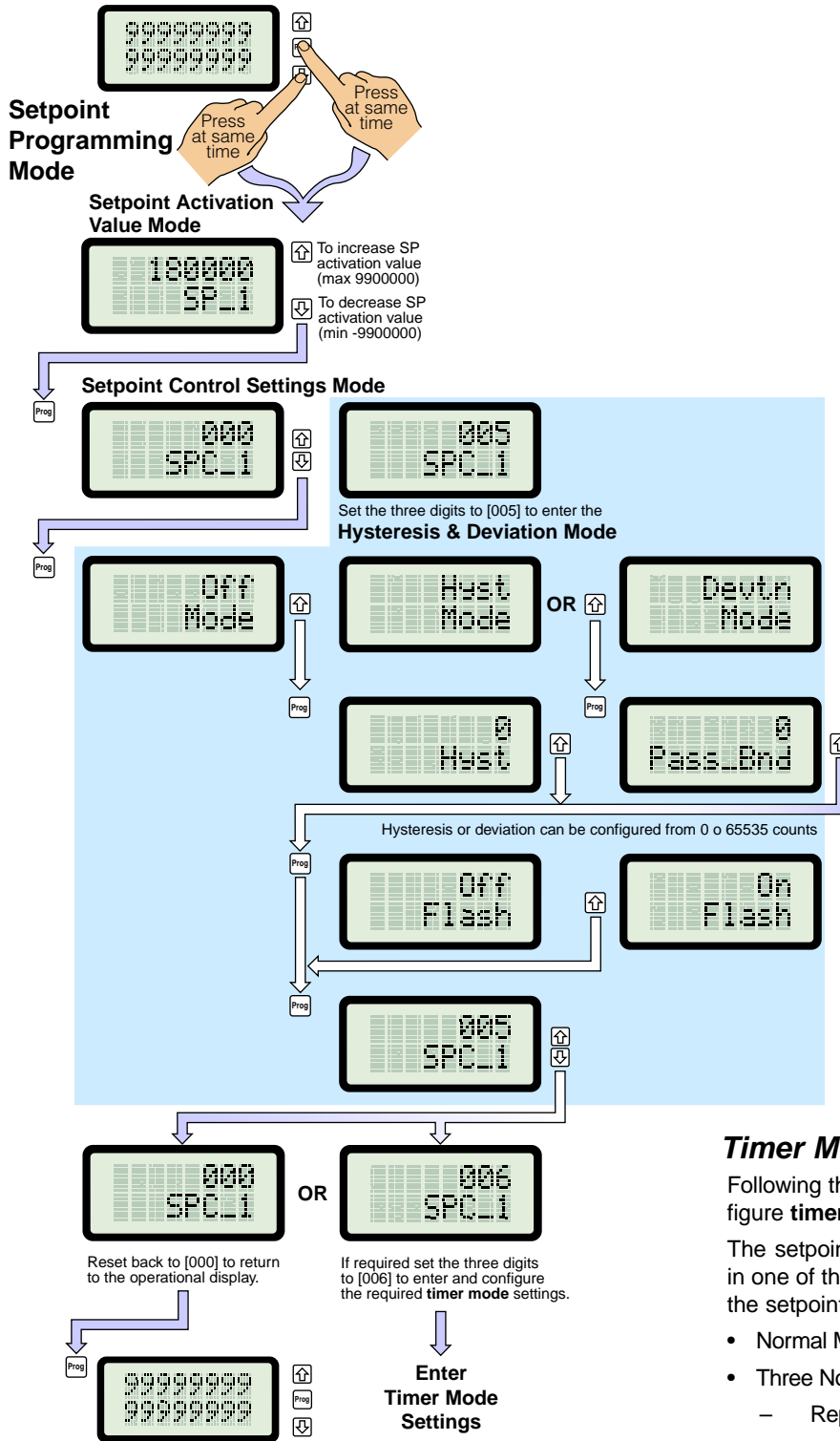

Display Flashing

Display flashing can be applied to the setpoint when configured in the hysteresis or deviation mode.

The setpoint can be programmed to make the display flash on and off while the setpoint is active, and keep it flashing until the setpoint de-activates.

Timer Modes

Following the setpoint setup sequence, the next step is to configure **timer mode** settings if required.

The setpoint/relay can be individually programmed to operate in one of the following timer modes, energizing above or below the setpoint value:

- Normal Mode.
- Three Normally OFF, Pulsed ON Modes:
 - Repeat ON mode.
 - Pulse ON mode.
 - 1-Shot ON mode.
- Three Normally ON, Pulsed OFF Modes:
 - Repeat OFF mode.
 - Pulse OFF mode.
 - 1-Shot OFF mode.

All timer modes have timer delay resolution of 0.1 up to 6553.5 seconds. If the setpoint does not require timer mode settings, the mode can be set to OFF.

Deviation

Deviation (passband) is the programmable setting around which the setpoint can be programmed to energize the relay inside or outside the deviation band.

The deviation setting can be any value between 1 and 65535 counts. The number of counts selected act both positively and negatively on the setpoint, forming a deviation band around the setpoint.

For example, if the setpoint setting is 1000 counts and the deviation setting is 35 counts, the deviation band around the setpoint setting is 70 counts starting at 965 counts and ending at 1035 counts.

Setpoint Programming Mode continued

Setpoint Programming Mode

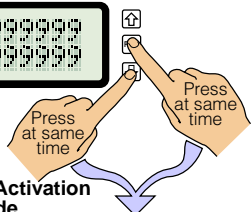
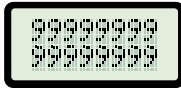

Setpoint Activation Value Mode



↑ To increase SP activation value (max 9900000)
 ↓ To decrease SP activation value (min -9900000)

Setpoint Control Settings Mode



↑ Set the three digits to the required setpoint control settings
 ↓

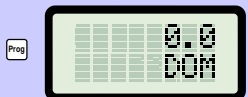

↑ To increase DOM value (max 65535)
 ↓ To decrease DOM value (min -65535)



↑ To increase DOB value (max 65535)
 ↓ To decrease DOB value (min -65535)

OR



↑ To increase DOM value (max 65535)
 ↓ To decrease DOM value (min -65535)



↑ To increase minimum-on value (max 65535)
 ↓ To decrease minimum-on value (min -65535)

OR



↑ To increase DOM value (max 65535)
 ↓ To decrease DOM value (min -65535)



↑ To increase on-time value (max 65535)
 ↓ To decrease on-time value (min -65535)

OR



↑ To increase Off-time value (max 65535)
 ↓ To decrease Off-time value (min -65535)



↑ To increase on-time value (max 65535)
 ↓ To decrease on-time value (min -65535)

OR

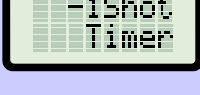

↑ To increase minimum-off value (max 65535)
 ↓ To decrease minimum-off value (min -65535)

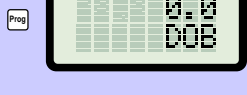

↑ To increase DOB value (max 65535)
 ↓ To decrease DOB value (min -65535)

OR

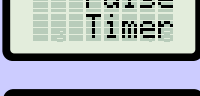

↑ To increase Off-time value (max 65535)
 ↓ To decrease Off-time value (min -65535)



↑ To increase DOB value (max 65535)
 ↓ To decrease DOB value (min -65535)

OR



↑ To increase Off-time value (max 65535)
 ↓ To decrease Off-time value (min -65535)



↑ To increase on-time value (max 65535)
 ↓ To decrease on-time value (min -65535)



Reset back to [000] to return to the operational display.

OR



If required set the three digits to [007] and set the required trigger & reset settings.

See trigger & reset mode settings on Page 35



Normal Mode

This is a single actuation mode that individually programs the setpoint with delay-on-make (DOM) and delay-on-break (DOB) settings.

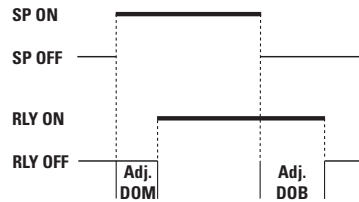

When the SP deactivates, the DOB delay keeps the relay energized for the programmed time period.



Note:
DOM and DOB settings can be programmed to zero. This allows for instant relay operation.

When the signal activates the setpoint, the DOM prevents the relay from energizing until the programmed DOM delay is complete. If the SP is active for less than the DOM time, the relay does not energize.

See **Timer Mode Example 1 – NORMAL Mode Time Control**, for examples of the normal mode.

Normally OFF / Pulsed ON Modes

These are time control modes where the relay is normally OFF (de-energized) and pulses ON (energizes) when the setpoint activates.

Repeat ON Mode

The repeat ON mode is a multiple actuation mode with programmable adjustable off-time and on-time settings.

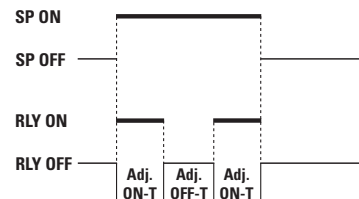

In this mode the on-time setting activates first. When the signal activates the setpoint, the relay energizes immediately and remains energized for the programmed ON-T setting.

When the ON-T delay is complete, the relay de-energizes and the OFF-T delay starts the cycle again. The ON-T and OFF-T settings continually repeat as long as the SP is active. If the SP deactivates, the relay de-energizes immediately.

See **Timer Mode Example 2 – REPEAT ON Mode Time Control**, for examples of the repeat on mode.

Pulse ON Mode (Programmable Maximum On-time)

The pulse ON mode is a single actuation mode with programmable DOM and maximum on-time settings.

When the signal activates the setpoint, the DOM prevents the relay from energizing until the programmable DOM setting times out.

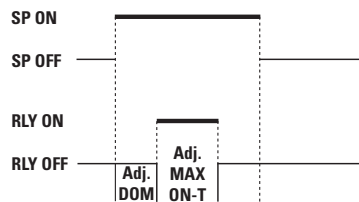

The ON-T then energizes the relay for the MAXIMUM programmed on-time period.

For the pulse mode to repeat, the SP must deactivate and then activate again. If the SP deactivates, the maximum on-time setting keeps the relay energized until the ON-T times out.

See **Timer Mode Example 3 – PULSE ON Mode Time Control**, for examples of the pulse on mode.

1-Shot ON Mode (Programmable Minimum On-time)

The 1-shot ON mode is a single actuation mode with programmable DOM and minimum on-time settings.

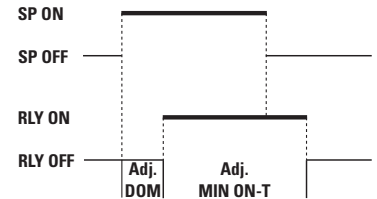

When the signal activates the setpoint, the DOM prevents the relay from energizing until the programmable setting times out.

The MIN-ON then energizes the relay for at least the minimum programmed on-time setting.

If the SP deactivates, the relay remains energized for as long as the programmed MIN-ON period. If the SP remains active for longer than the MIN-ON period, the relay remains energized until the SP deactivates, at which point the relay de-energizes.

See **Timer Mode Example 4 – 1-SHOT ON Mode Time Control**, for examples of the 1-shot on mode.

Normally ON / Pulsed OFF Modes

These are time control modes where the relay is normally ON (energized) and pulses OFF (de-energizes) when the setpoint deactivates.

1-Shot OFF Mode (Programmable Minimum Off-time)

The 1-shot OFF mode is a single actuation mode with programmable DOB and minimum off-time settings.

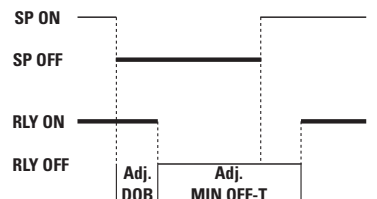

When the signal deactivates the setpoint, the relay remains energized until the programmable DOB period times out.

The MIN OFF-T then de-energizes the relay for the minimum programmed off-time period.

If the SP activates during the MIN OFF-T phase, the relay remains de-energized for as long as the programmed MIN OFF-T period and then energizes again.

See **Timer Mode Example 5 – 1-SHOT OFF Mode Time Control**, for examples of the 1-shot off mode.

Pulse OFF Mode (Programmable Maximum Off-time)

The pulse OFF mode is a single actuation mode with programmable DOB and maximum off-time settings.

When the signal deactivates the setpoint, the relay remains energized until the programmable DOB setting times out.

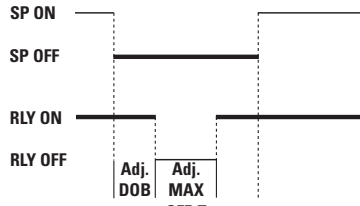

The OFF-T then de-energizes the relay for the MAXIMUM programmed off-time period.

For the pulse mode to repeat, the SP must activate and then deactivate again.

If the SP activates during the OFF-T phase, the relay remains de-energized until the OFF-T times out and then energizes.

See **Timer Mode Example 6 – PULSE OFF Mode Time Control**, for examples of the pulse off mode.

Repeat OFF Mode

See Figures 31 and 32. The repeat OFF mode is a multiple actuation mode with programmable off- and on-time settings.

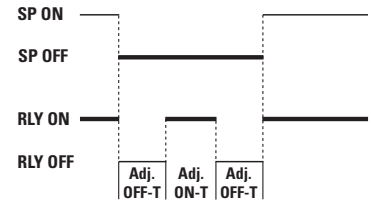

In this mode the off-time setting activates first. When the signal deactivates the setpoint, the relay remains de-energized for the programmed OFF-T setting and energizes when the ON-T setting activates.

When the ON-T setting is complete, the relay de-energizes and the OFF-T delay starts the cycle again. The OFF-T and ON-T settings continually repeat as long as the SP is deactivated. If the SP activates, the relay energizes immediately.

See **Timer Mode Example 7 – REPEAT OFF Mode Time Control**, for examples of the repeat off mode.

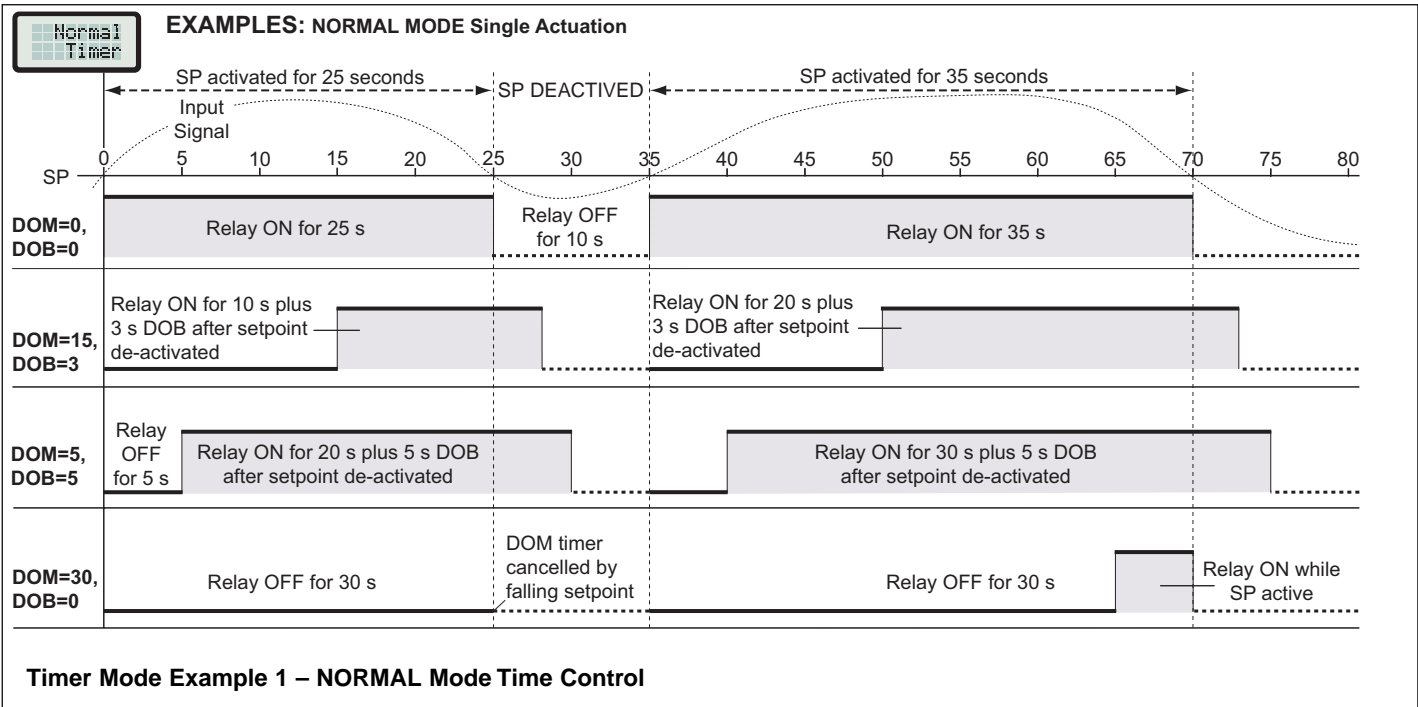

Setpoint Programming Mode continued

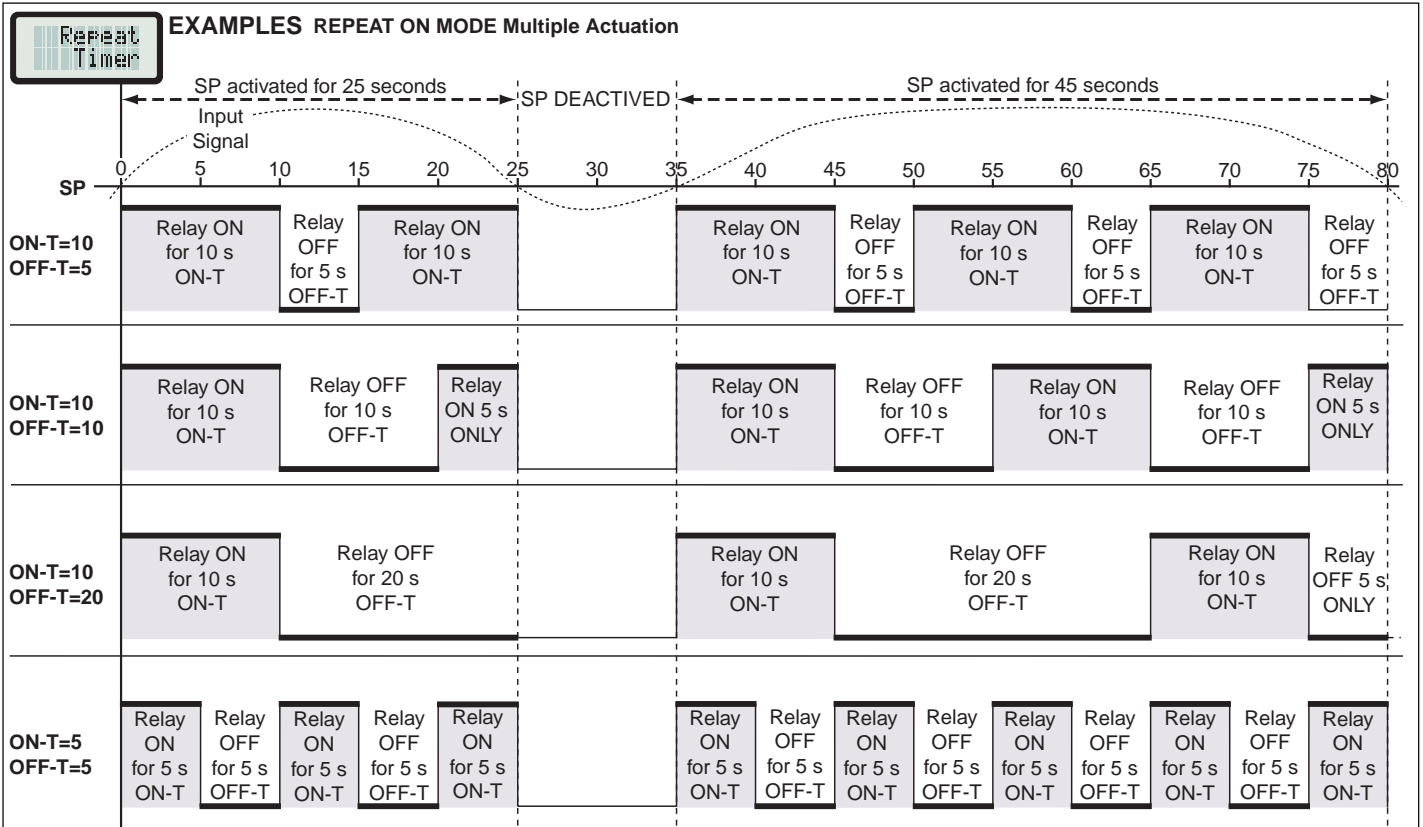

Timer Mode Example 2 – REPEAT ON Mode Time Control

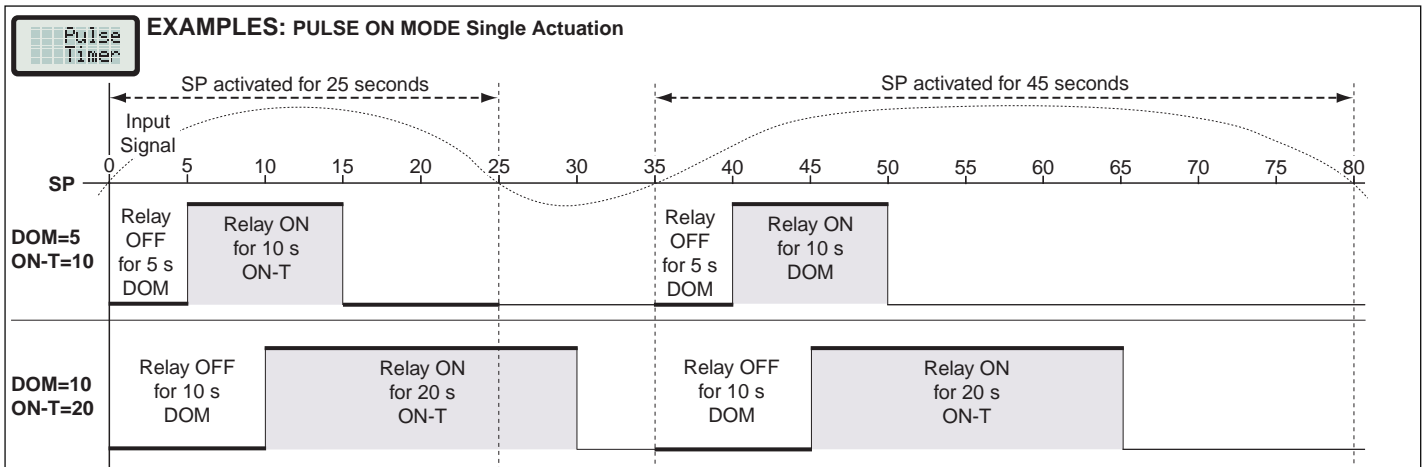

Timer Mode Example 3 – PULSE ON Mode Time Control

Setpoint Programming Mode continued

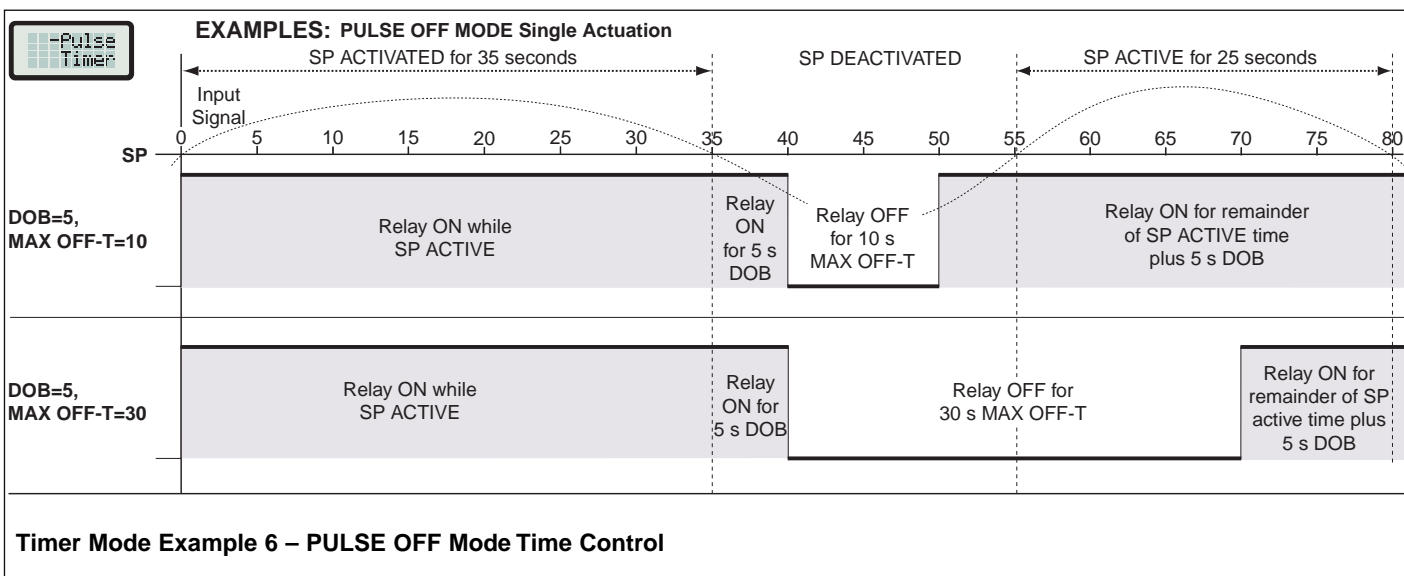
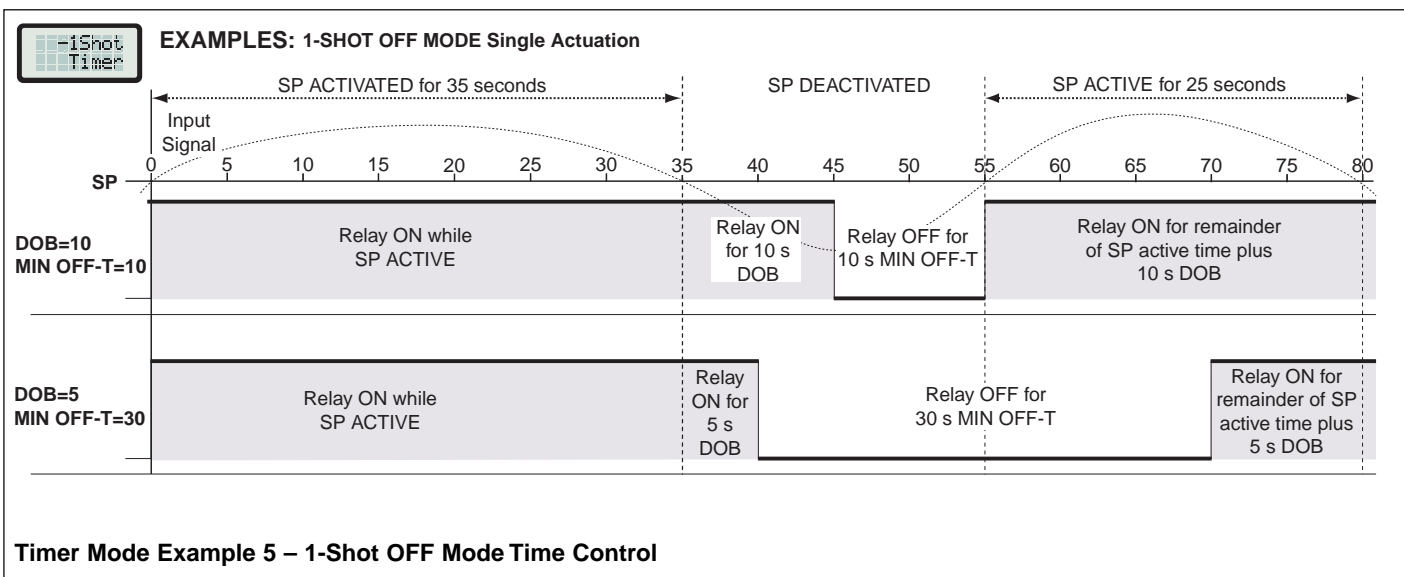
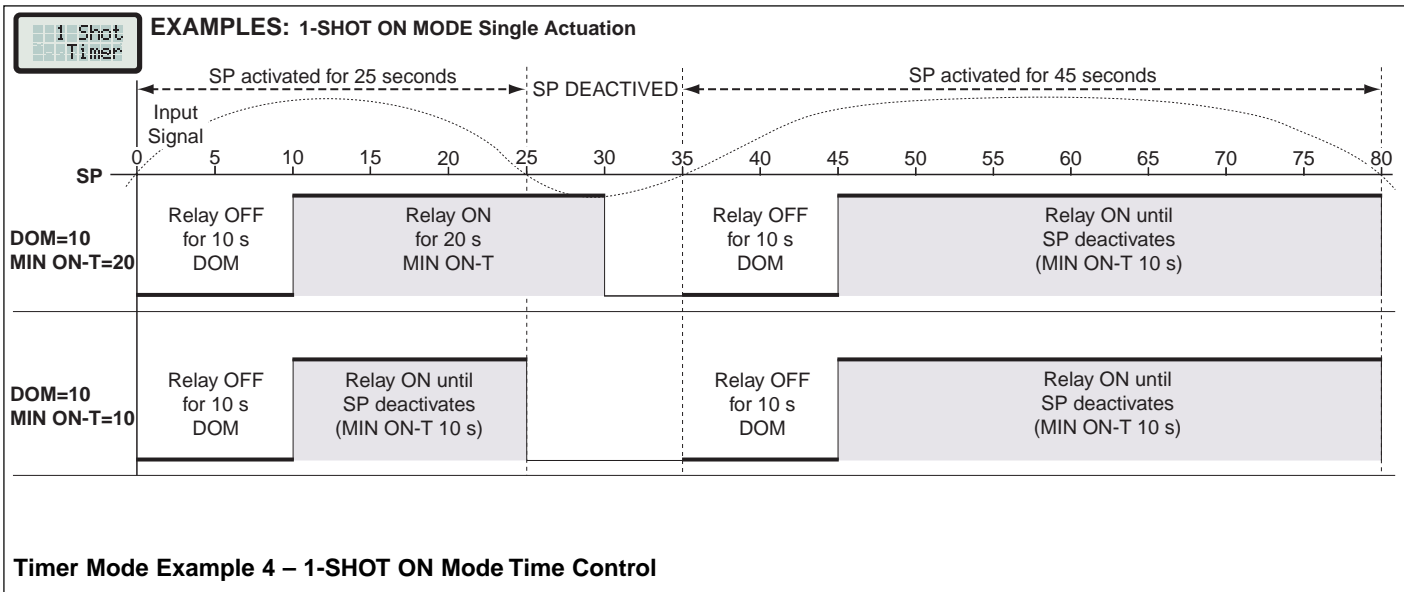

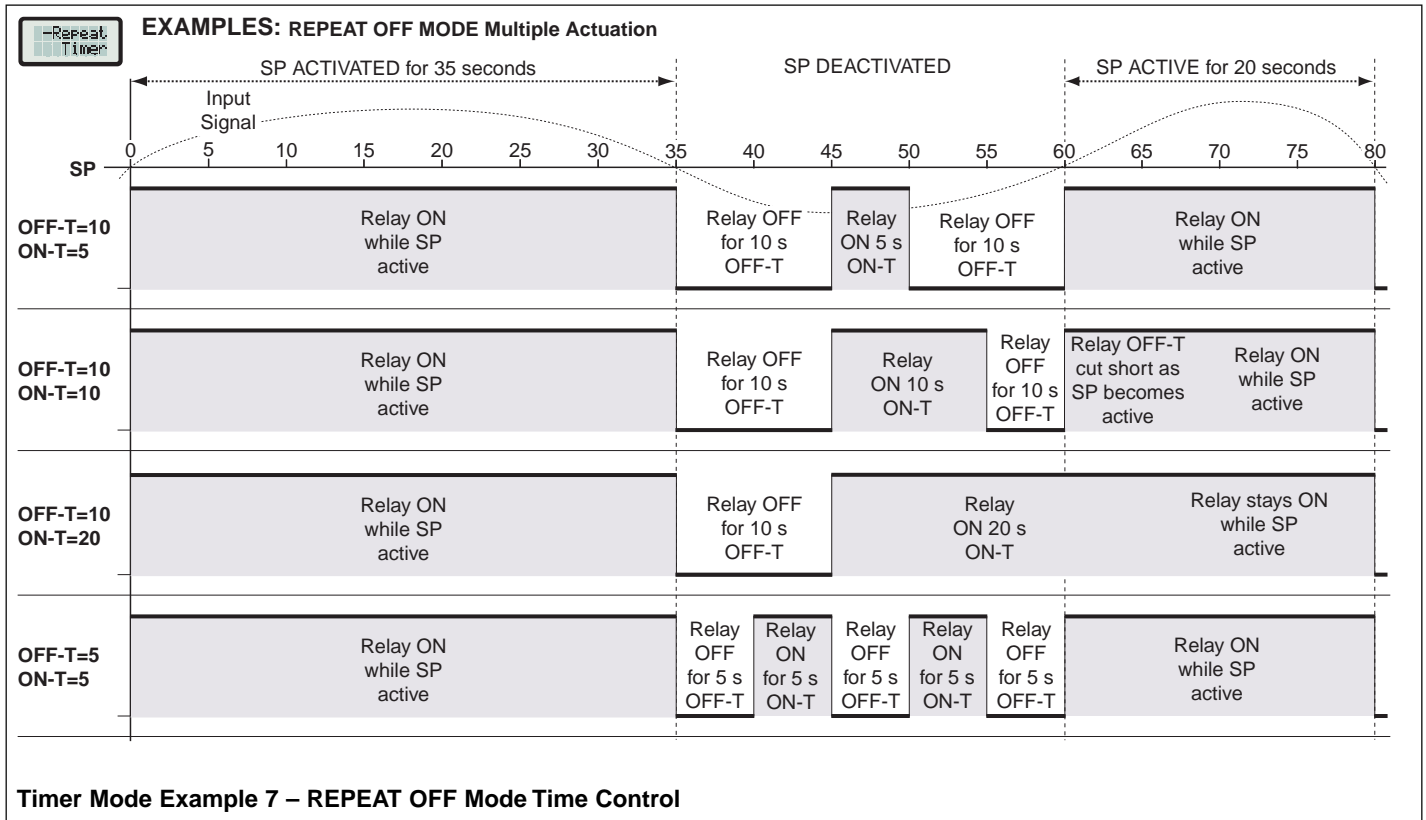

Setpoint Trigger & Reset Mode

While following the setpoint setup sequence, the next step is to configure the **trigger & reset mode** settings if required.

This mode allows you to configure the following setpoint trigger and specific function reset functions. If not required, the mode can be set to OFF.

- Trigger Settings [Trig].
- Reset Destination Settings [Dest].
- Reset Mode Settings [Mode].
- Reset Constant Settings [Res_Cons].

Trigger Settings

The trigger setting provides the option of selecting which edge of the relay operation the reset function activates on. It can be set to:

- **Make** – Operate on the make edge only.

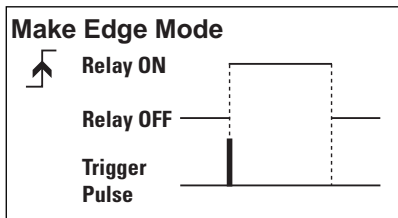

- **Break** – Operate on the break edge only.

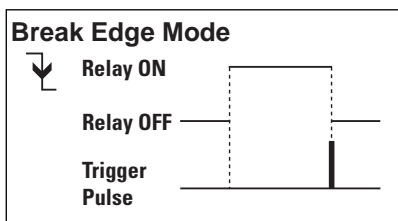

- **Both** – Operate on both make and break edges.

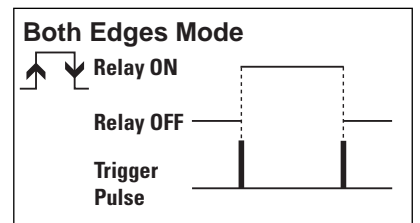

- **Level** – Operate after every sample period if relay is on.

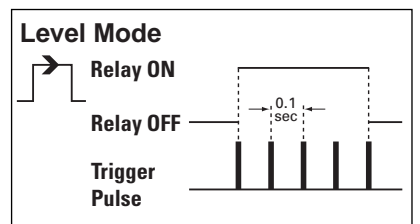

Reset Destination Settings

The **reset destination setting** defines the target function in the meter that is to be modified in some way when the reset trigger conditions for the relay are met.

If the destination [Dest] setting is set to [Off], the **reset** part of the function is disabled and the **reset mode** [Mode][Constant] and **reset constant** [Res_Cons] selections are not displayed. The **trigger** setup sequence is complete and the display jumps straight back to [SPC_1] [007] where you can return to the operational display or carry on with further programming.

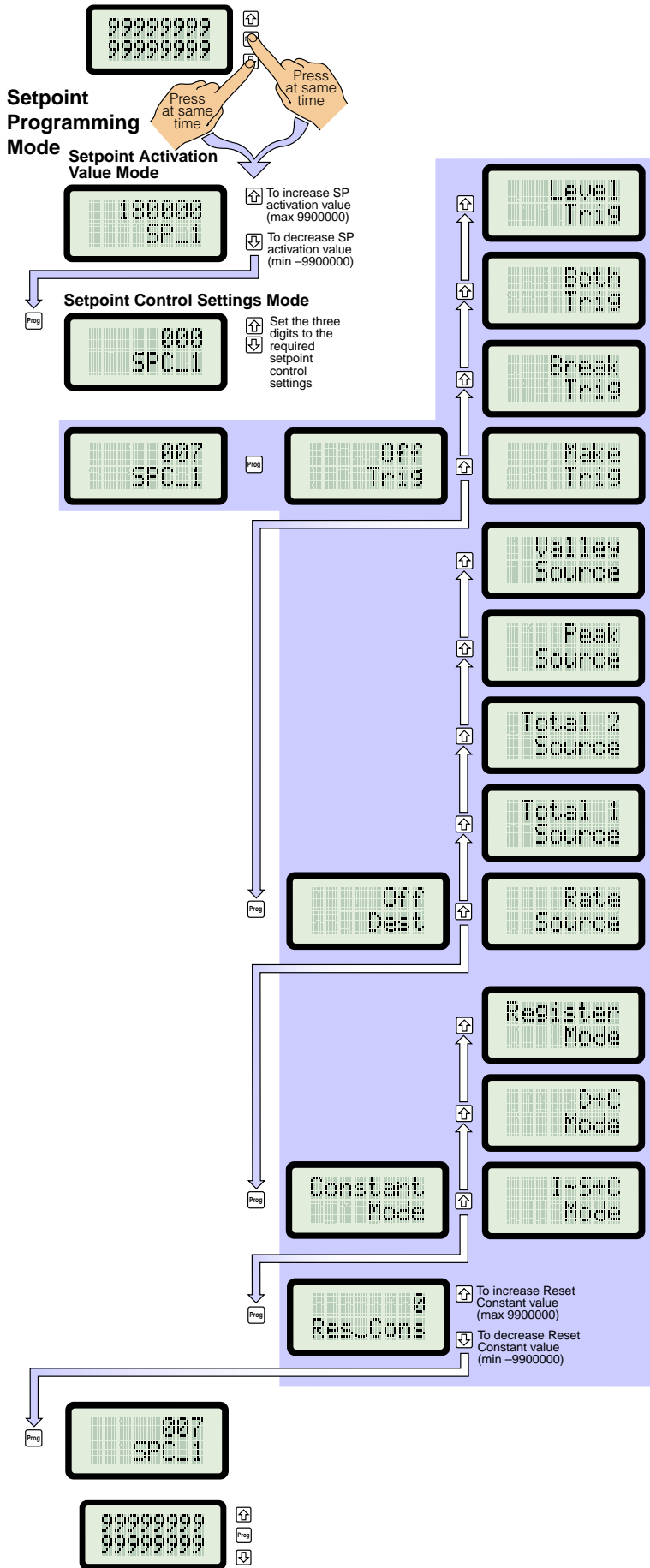

Reset Mode Settings

The reset mode setting defines what type of reset effect is required. The following options are available:

- **[Constant]** – This mode stores a user defined constant into the selected destination function. In most cases this number is zero, but it can be any number.
- **[I-S+C]** – This mode stores the current input value (I), defined by the setpoint activation source, minus the setpoint value (S), plus a user defined constant (C). It would normally be used with a counting or totalizing application where the amount of setpoint overshoot needs to be retained after the reset function. The constant value would normally be zero but could be used to provide an offset if required.
- **[D+C]** – This mode adds the user defined constant (C) to the current value in the selected reset destination function (D). It can be used to increment or decrement a function by any amount.
- **[Register]** – This mode copies the contents of a user selectable function into the reset destination function (see Reset Constant Settings to select source function).

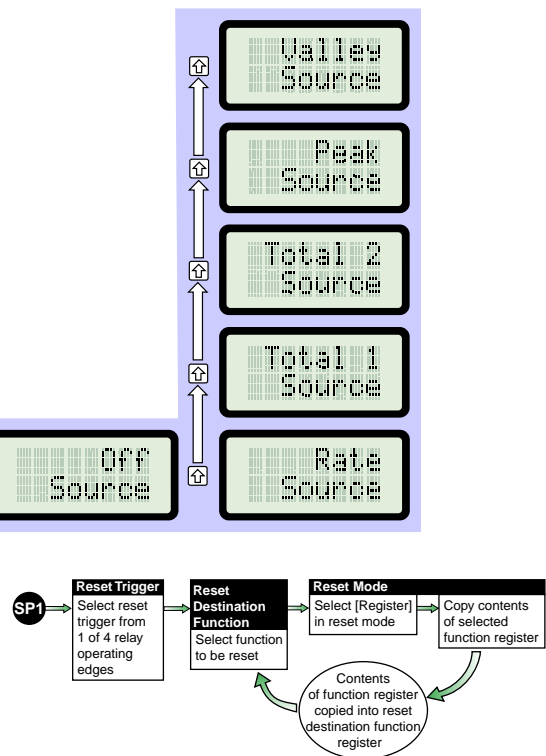

Reset Constant Settings

This setting defines the constant value to be used in the [Constant], [I-S+C], [D+C] modes explained in Reset Mode Settings above. Its default value is zero, but can be anywhere between -199999 and 999999. This setting is not available if [Register] is selected as the reset mode.

Source

If the **reset mode** is set to [Register] the source parameter allows you to select the destination function in the meter to be copied to the selected reset destination function.

Setpoint Setup Sequence

When configuring the setpoint it is generally good practice to follow the **setpoint setup sequence**. This ensures that all relevant setpoint control modes have been programmed and that final control settings are saved to memory before exiting the setpoint programming mode.

Step 1 Setpoint Activation Value



Enter this mode to adjust the setpoint activation value. The default setting is 180000 counts.

Step 2 Hysteresis & Deviation



Enter this mode if hysteresis or deviation control is required. If not required, this setting should remain **off**.

Step 3 Setpoint Timers



Enter this mode if timer control is required. If not required, this setting should remain **off**.

Step 4 Setpoint Trigger & Reset Functions



Enter this mode if setpoint trigger & reset control functions are required. If not required, this setting should remain **off**.

Step 5 Setpoint Activation Source Setup Mode



Enter this mode to select the activation source for the setpoint.

External Switching Functions



OR, If required, enter the appropriate number in the 2nd digit to select an external switching function as the activation source for the setpoint (see breakdown of setpoint programming mode control settings).

Step 6 Final Setpoint Control Settings

1st Digit: Select a relay energize function.

2nd Digit: If no external switching function is required, select 0 to activate the setpoint source.

3rd Digit: Select a latching and/or relay reset mode if required.

1 Setpoint Activation Value Settings

Step 1

Enter the Setpoint Programming Mode

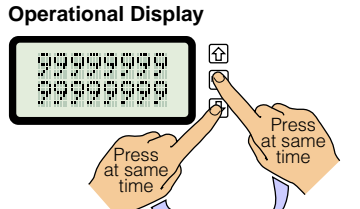

Step 2

Adjust the **setpoint activation value** to the required setting

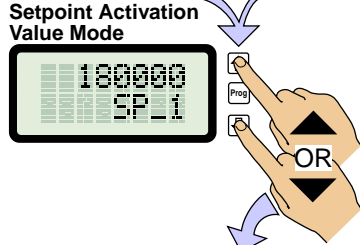

Step 3

Enter the Setpoint Control Settings Mode

Example

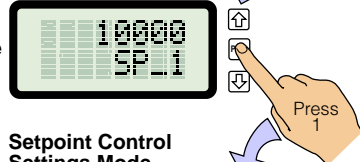

Step 4

Select [005] to access the Hysteresis & Deviation Mode

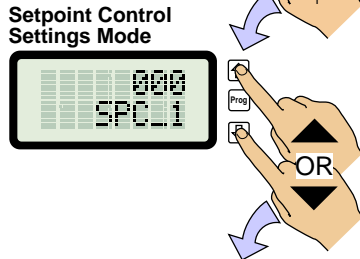

2 Hysteresis & Deviation Mode Settings

Step 5

Enter the Hysteresis & Deviation Mode

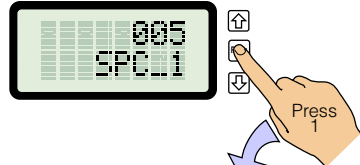

Step 6

Ensure the Hysteresis & Deviation Mode is set to [Off]

Example

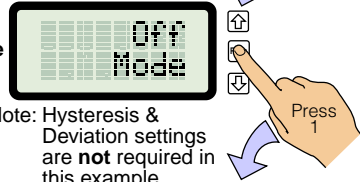

3 Setpoint Timer Settings

Step 7

Select [006] to access the Setpoint Timers Mode

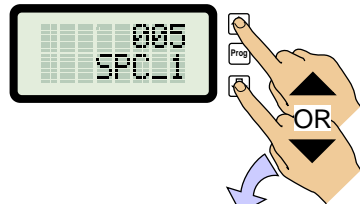

Step 8

Enter the Setpoint Timers Mode

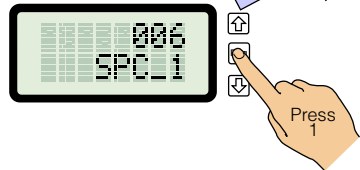

4 Setpoint Trigger & Reset Function Settings

Step 9

Ensure the Setpoint Timers Mode is set to [Off]

Example

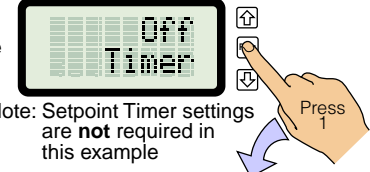

Step 10

Select [007] to access the Setpoint Trigger & Reset Function Mode

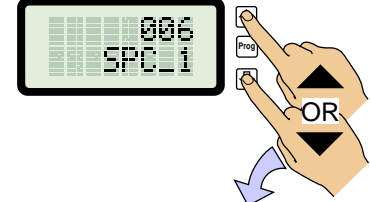

Step 11

Enter the Setpoint Trigger & Reset Function Mode

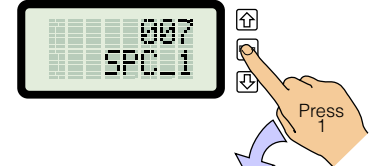

Step 12

Select the [Make] trigger setting

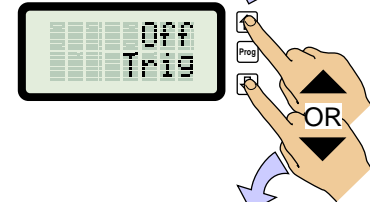

Step 13

Save the [Make] trigger setting and enter the reset destination setting menu

Example

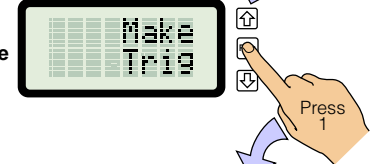

Step 14

Select the [Total 1] reset destination setting

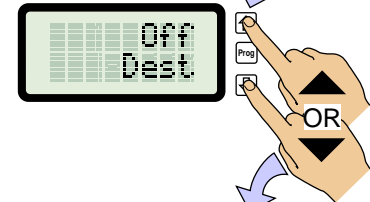

Step 15

Save the reset destination setting and enter the reset mode setting menu

Example

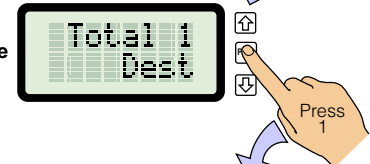

Step 16

Select the [I-S+C] reset mode setting

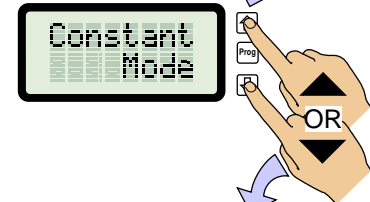

Step 17

Save the [I-S+C] reset mode setting and enter the reset constant setting menu

Example



To Step 9

Setpoint Programming Mode continued

From Step 17

Step 18

Set to the required **reset constant** setting

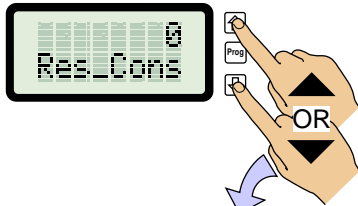

Step 19

Save the **reset constant** setting

Example

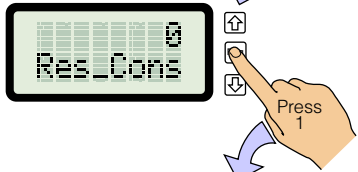

Step 20

Set the display to [010] to access the **setpoint activation source setup mode**

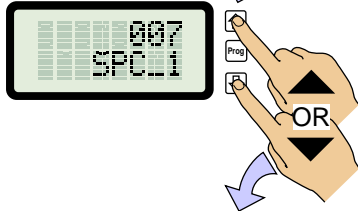

5 Setpoint Activation Source Setup Mode Settings

Step 21

Enter the **setpoint activation source setup mode**

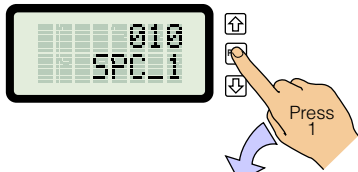

Step 22

Select the [Total 1] **setpoint activation source setup mode**

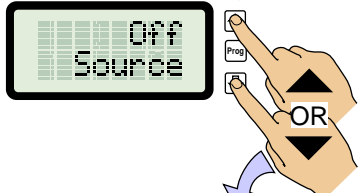

Step 23

Save the **setpoint activation source setup mode** setting

Example

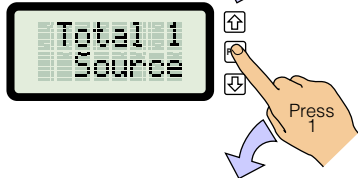

6 Final Setpoint Control Settings

From Step 23

Step 24

24.1. Adjust the 1st digit to 0 (zero) to energize the relay above the setpoint setting

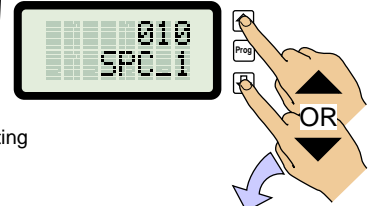

24.2. Adjust the 2nd digit setting to 0 (zero) as no external switching function is required.

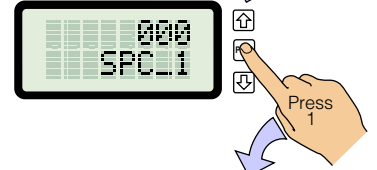

24.3. Adjust the 3rd digit setting to 0 as no relay latching and/or manual relay reset function is required.



Step 25

Return to the operational display

Operational Display

To Step 24

External Switching Function Settings

Not Required for this Example

Functional Diagram

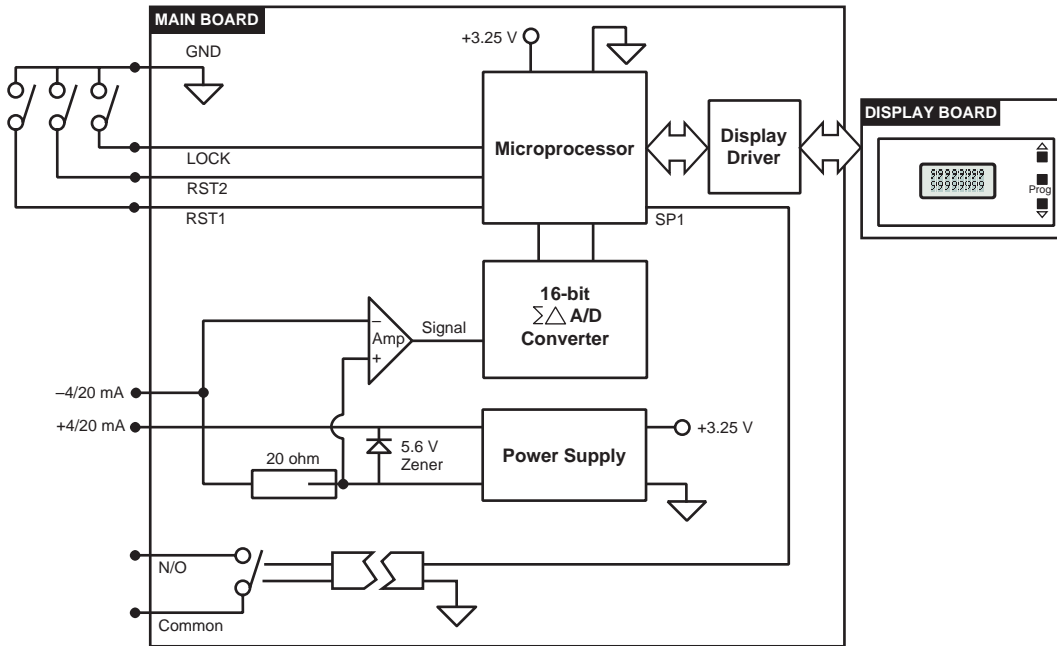

Connector Pinouts

Rear Panel Pinout Diagram

The meter uses plug-in type screw terminal connectors for all input and output connections.

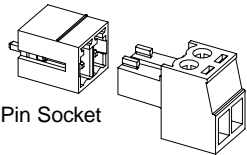
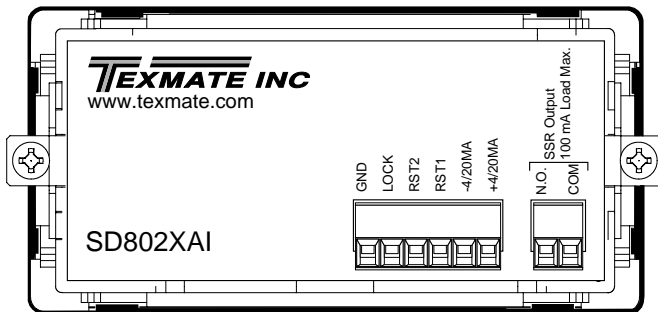

Pin Socket

Right-angled Screw Terminal Plug

Part Numbers:
93-PLUG2PS.....2 pins
93-PLUG6PS.....6 pins

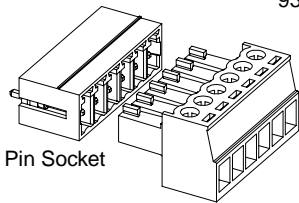

Pin Socket

Pin Descriptions

GND (Ground) Pin

To activate the LOCK, RST1, and RST2 pins from the rear of the meter, the respective pins have to be connected to the GND pin.

LOCK Pin

When connected to the GND (ground) pin, the LOCK pin prevents any programming changes being made to the meter.

If programming is attempted, the programming mode selected can be entered and the modes are displayed but cannot be changed.

RST1 Pin

When connected to the GND pin, the RST1 pin resets totalizer 1 to zero.

RST2 Pin

When connected to the GND pin, the RST2 pin resets totalizer 2 to zero.

-4/20 mA

Input low series connection to 4 to 20 mA DC current loop.

+4/20 mA

Input high series connection to 4 to 20 mA DC current loop.

N.O.

Normally open 210 mA SSR contact (100 mA load maximum).

COM

Common 210 mA SSR contact (100 mA load maximum).



Note:

The RST1, RST2, and LOCK pins can also be used as the activation source for the setpoint. Selecting one of these external switch settings in the 2nd digit overrides any other setpoint activation source setting.

Custom Faceplates

Texmate Produces Thousands of Custom OEM Faceplates

Have Texmate design and build a custom faceplate to suit your next project!



Custom faceplates have a non-recurring artwork charge. A **serial number** is then assigned to each artwork to facilitate re-ordering.

Small run or **one-off** custom faceplates incur an installation charge, and are generally printed on a special plastic film that is then laminated to custom faceplate blanks as required.

The **non-recurring artwork charge** is less if you choose elements from our library.

See *Texmate Short Form Catalog with Prices for a library of standard scales and captions.*

Large run (250 pieces minimum) custom faceplates are production silk screened, issued a part number, and held in stock for free installation as required by customer orders.

OEMs may also order custom **meter labels, box labels, data sheets** and **instruction manuals.**

Custom Faceplate Design Template

Use the templates below to see how your logo looks and fits.

Standard NEMA-4X Water and Dust-proof Membrane Touch-pad Panel

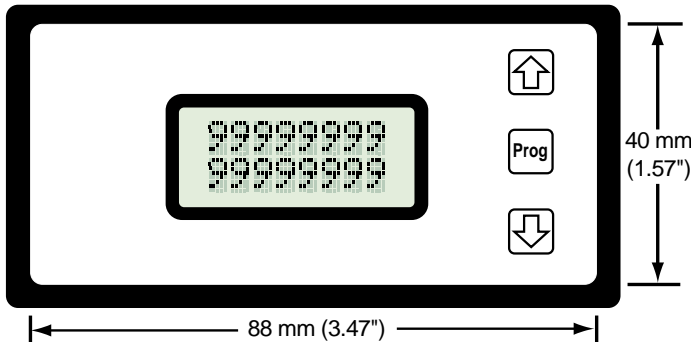

Note:
Black is the standard faceplate color for these models.

Optional Push-button Panel

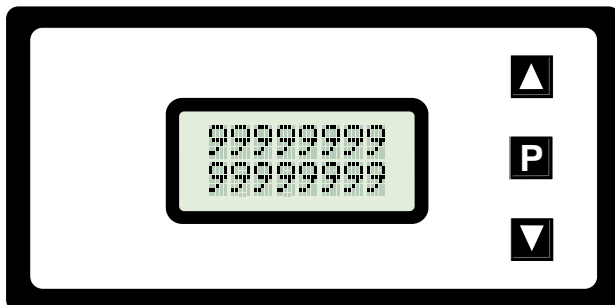

Optional Caption Sheets

AHEAD	AC Vars	AC Amperes	AC Kilowatts	AIR PRESSURE	AC Milliampers
ALARM	AC Volts	AC Kilovars	AC Millivolts	AC Kiloampers	Battery Voltage
BOILER	AC Watts	AC Kilovolts	BPH X 1000	AC Megavars	Backup Voltage
Cycles	BEARING	AIR FLOW	CFH x 1000	AC Megawatts	Displacement
Depth	COOLANT	BBL/SHOUR	DC Amperes	AC Watts/Vars	DC Amps to Ground
HEATER	DC Volts	BFM AMPS	DC Kilovolts	CENTIMETERS	DC Microampers
Height	DC Watts	BHP x 100	DC Kilowatts	DC Kiloampers	DC Milliampers
Hertz	Degrees	BLOWER	DC Millivolts	FD FAN AMPS	GALLONS / MINUTE
Hours	ENGINE	DC Current	FPM X 100	IN. H ₂ O PRESS	GENERATOR AMPS
INCHES	EXHAUST	Dew Point	FPM X 1000	LBS/MINUTE	LBS PER GALLON
Input	Humidity	Degrees C	GPM X 1000	LEVEL INCHES	LOAD LIMIT PERCENT
PORT	METERS	Degrees F	HORSEPOWER	LEVEL GALLONS	MANIFOLD PRESSURE
PUMP	Output	Degrees K	INCHES WC	LEVEL PERCENT	MILL LOAD AMPS
Preset	Percent	Degrees R	INCHES H ₂ O	MILLIMETERS	MOTOR LOAD AMPS
Reset	Program	FPM X 10	KILOWATTS	Percent Current	Percent Horsepower
SHAFT	Pounds	Frequency	LBS X 1000	Percent Load	OXYGEN PERCENT
SPEED	Pulses	FUEL FLOW	MEGAWATTS	PERCENT OPEN	TEMPERATURE °C
Setup	RUDDER	GALLONS	Power Factor	RATE of TURN	TEMPERATURE °F
TABLE	SPINDLE	IN. WATER	Phase Angle	STEAM TEMP °F	Motor Load Percent
Total	SQ ROOT	LEVEL FT.	RPM X 100	TONS / HOUR	LEFT RIGHT
VALVE	Set Point	LBS X 100	STARBOARD	OIL PRESSURE	FRONT REAR
Valley	THRUST	POSITION	TANK LEVEL	WATER LEVEL	FORWARD REVERSE
WATTS	TURBINE	TONS X 10	VAC MM HG	1000 LBS/HOUR	TOP BOTTOM (L419)

Sample Caption Sheets
not to scale

White or black lettering for
do-it-yourself customizing

A	AC	E _b	Btu	bars	CFH	BHP	Low	inch/	CosØ	AMPS	BBL/HR
J	Ah	KJ	bar	cal ₁₅	CFM	IPS	High	Kcal	FEET	GALS	BBL/MIN
K	cd	kV	cal	cm ⁻¹	CFS	IPH	MGD	kg/hr	Hold	INHg	DEG/MIN
l	dB	KW	cm	cm ²	COS	Kg/h	Mld	kVAR	Km ³ /h	m/min	FT H ₂ O
m	DC	ml	FT ³	cm ³	CPH	KPH	MPH	kW/s	MWH	m/sec	In. H ₂ O
V	FT	NL	lbs	dm ³	CPM	KPM	MPS	RPM	mWs	Nm ³ /h	Kg/cm ²
α	HP	Pa	IN ²	H ₂ O	CPS	KPS	N/m ²	MPM	mbar	Ohms	KNOTS
β	Hz	PF	kg/	kPa	DCA	kWH	ORP	M ³ /hr	ml/m ³	PSIA	kg/sec
φ	Kg	pH	mA	l/s	FPH	lb/ft	PPH	Upm	mm/s	PSID	Mvars
Ω	kA	sin	mS	l/h	FPM	lb/in	PPM	VAC	Peak	PSIG	mmH ₂ O
Δ	L ³	t/h	mV	l/m	FPS	LPH	PPS	Vars	PORT	PSIR	mmHg
μ	m ³	yd ³	Nm	lb/h	GAL	LPM	RPH	VDC	STRB	SCFM	VOLTS
∅	W	μA	oz	MW	GMP	LPS	RPS	w/m ²	TARE	TORR	%LOAD
Υ	°C	μS	RH	min	GPH	m ³ /h	phi	YPM	TONS	U/min	%OPEN
%	°F	μV	1/h	mm	GPM	m ³ /m	psi	YPS	X100	x10kN	→
∠	°K	μΩ	μm	Sm ³	GPS	m ³ /S	X10	μPa	%KW	X1000	← (L419)

Faceplate Ordering Information

Part Number **Description** **List**

Custom Faceplates for Meters

ART-FS-S/D	Custom Faceplate, No Min. - Artwork & set-up\$35
ART-FS-S/D/C	Custom Faceplate, No Min. - Artwork & set-up + Logo\$75
ART-FS-001	Produce & Install Custom Faceplate per meter - 1 color\$10
ART-FS-002	Produce & Install Custom Faceplate per meter - 2 color\$20
ART-FS-003	Produce & Install Custom Faceplate per meter - 3 color\$30

Specify artwork serial number when ordering faceplate installation. ie: AFS-XXXXX

Large Run Custom Faceplates for Meters

ART-FL-S/D/C	Custom Faceplate, 250 Min. - Artwork & set-up + Logo\$75
ART-FL-001	Custom Faceplate, 250 Min. (\$1.00 each) - 1 color\$250
ART-FL-002	Custom Faceplate, 250 Min. (\$1.40 each) - 2 color\$350
ART-FL-003	Custom Faceplate, 250 Min. (\$1.80 each) - 3 color\$450

When ordering large run faceplates to be installed, please specify the custom part number issued for each different artwork. ie: 77-DLXXXXX



Model and Software Code Version Check

The meter model and software code version numbers can be checked at any time while in the operational display using the following procedure.

Notes

MODEL & SOFTWARE CODE VERSION CHECK

Step 1

Press and hold the  and  buttons

Step 2

While holding both buttons, press the  button then release all three buttons

Step 3

The meter displays the software version number and the model number of the meter for approx. 5 secs before returning to the operational display

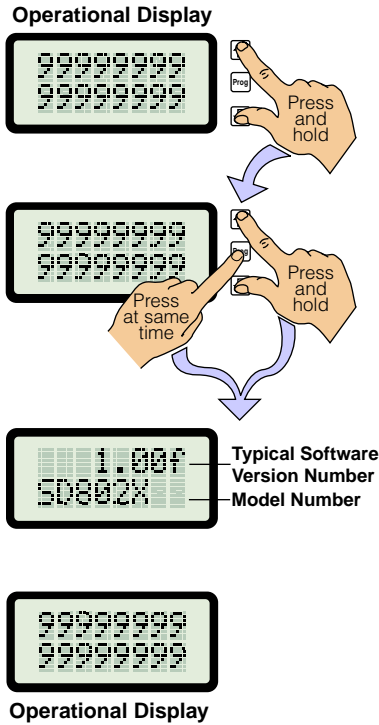

Example

Model No:
Software Version No:



Programming Tip

The *Model and Software Code Version* checking procedure can be performed at any time without interfering with other configuration settings.

Main Programming Mode

Calibration Mode

Skip
Cal_Rate

Tick frequency setting
Frequency: 50 Hz 60 Hz

Tick response setting
Response: Linear Square Root

Zero Setting = _____ Counts

Span Setting = _____ Counts

Totalizer Mode

Skip
Cal_Tot

Totalizer 1: Input = _____ Totalizer 2: Input = _____
 After = _____ After = _____
 Total = _____ Total = _____
 Cutoff = _____ Cutoff = _____
 Rollover = _____ Rollover = _____

Signal Filtering Mode

Skip
Filter

Averaging Samples = _____
 Averaging Window = _____

Display Source Mode

Rate
Display1

Tick selected source

Source: Rate
 Total 1
 Total 2
 Peak
 Valley

Rate
Display2

Tick selected source

Source: Rate
 Total 1
 Total 2
 Peak
 Valley

Display Format Mode

Skip
Disp_Fmt

Input: Rate Last Digit Descriptor = _____
 Decimal Point Position 9 9 9 9 9
 Input: Total 1 Last Digit Descriptor = _____
 Decimal Point Position 9 9 9 9 9
 Input: Total 2 Last Digit Descriptor = _____
 Decimal Point Position 9 9 9 9 9

Setpoint Programming Mode

Setpoint Activation Value

100000
SP_L1

Setting = _____ Counts

Setpoint Activation Source Setup Mode

X1X
SPC_L1

Tick selected source

Source: Rate
 Total 1
 Total 2
 Peak
 Valley

Hysteresis & Deviation Mode

XX5
SPC_L1

Hysteresis Setting = _____

Deviation Setting = _____

Timers Mode

XX6
SPC_L1

Normal: DOM = _____ DOB = _____
 1-Shot: DOM = _____ Min-on = _____
 Pulse: DOM = _____ On-T = _____
 Repeat: Off-T = _____ On-T = _____
 -1-Shot: Min-on = _____ DOB = _____
 -Pulse: Off-T = _____ DOB = _____
 -Repeat: Off-T = _____ On-T = _____

Setpoint Trigger Mode

XX7
SPC_L1

Reset Trigger = _____
 Reset Destination = _____
 Reset Mode = _____ Source = _____

1st Digit 2nd Digit 3rd Digit

This Page Intentionally Left Blank

This Page Intentionally Left Blank

Case Dimensions

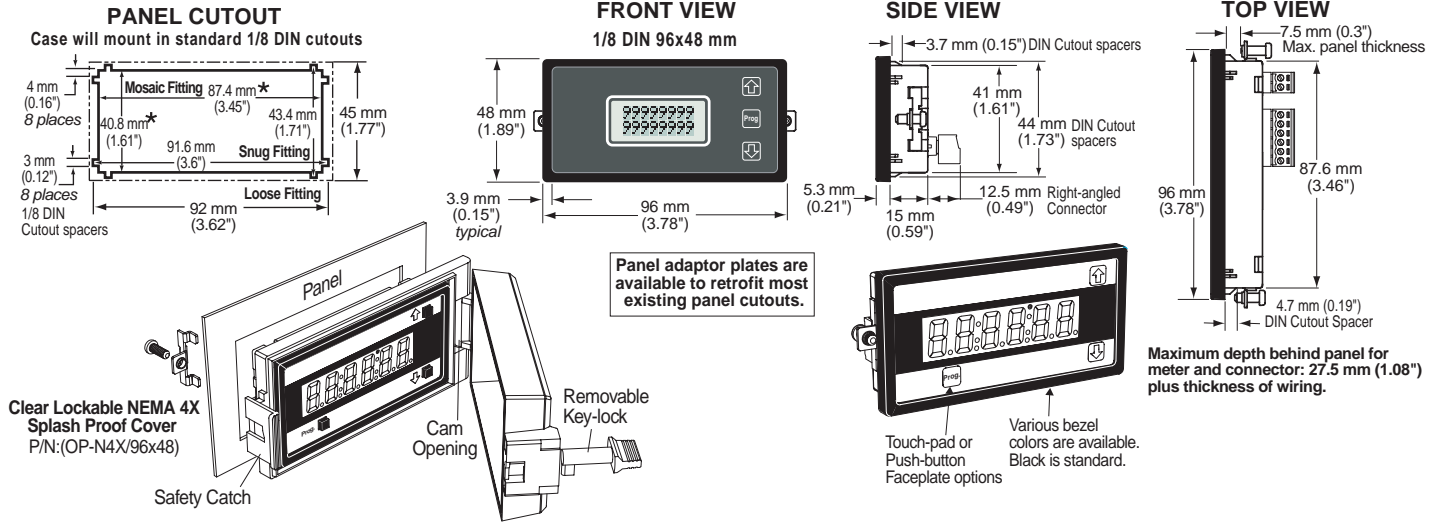

Ordering Information

Standard Options for this Model Number

Part Number	Description	List
-------------	-------------	------

► BASIC MODEL NUMBER

Includes plug-in type screw terminals and standard LCD display.

SD-802XAIDPM, 4 to 20 mA DC Loop Powered Touch-pad Faceplate . . \$239

Special Options and Accessories

► SPECIAL OPTIONS

CB-FS50Custom Scaling within the standard 4 to 20 mA range \$18

► ACCESSORIES (Specify Serial # for Custom Artwork Installation)

- 75-DBBZ9648FBlack Bezel for 96x48 mm Case \$2
- 93-PLUG2P-DPExtra Screw Terminal Conn., 2 Pin Plug \$3
- OP-N4X/96X48Clear Lockable Water-proof cover, Nema 4X, IP65 \$20
- OP-SD50XPBPush-Button faceplate option for SD-50X \$5
- OP-PSA/96X48Panel Cutout Reinforcer with O-Ring Seal \$7

- OP-PMA96X48Panel Cutout Reinforcer with 2 Brackets & Clips \$12
- ART-FS-S/DNRC for Artwork & set-up Custom Faceplate and or Descriptors \$35
- ART-FS-S/D/CNRC for Artwork & set-up Custom Faceplate and Custom Logo \$75
- ART-FS-001Produce & Install Custom Faceplate per meter - 1 color no-min \$10
- ART-FS-002Produce & Install Custom Faceplate per meter - 2 color no-min \$20
- ART-FS-003Produce & Install Custom Faceplate per meter - 3 color no-min \$30
- ART-FL-001Custom Faceplate, 250 piece Min. (\$1.00 each) - 1 color \$250
- ART-FL-002Custom Faceplate, 250 piece Min. (\$1.40 each) - 2 color \$350
- ART-FL-003Custom Faceplate, 250 piece Min. (\$1.80 each) - 3 color \$450

Many other options and accessories are available. See full price list for more details.

All Prices subject to change without notice.

WARRANTY

Texmate warrants that its products are free from defects in material and workmanship under normal use and service for a period of one year from date of shipment. Texmate's obligations under this warranty are limited to replacement or repair, at its option, at its factory, of any of the products which shall, within the applicable period after shipment, be returned to Texmate's facility, transportation charges pre-paid, and which are, after examination, disclosed to the satisfaction of Texmate to be thus defective. The warranty shall not apply to any equipment which shall have been repaired or altered, except by Texmate, or which shall have been subjected to misuse, negligence, or accident. In no case shall Texmate's liability exceed the original purchase price. The aforementioned provisions do not extend the original warranty period of any product which has been either repaired or replaced by Texmate.

USER'S RESPONSIBILITY

We are pleased to offer suggestions on the use of our various products either by way of printed matter or through direct contact with our sales/application engineering staff. However, since we have no control over the use of our products once they are shipped, NO WARRANTY WHETHER OF MERCHANTABILITY, FITNESS FOR PURPOSE, OR OTHERWISE is made beyond the repair, replacement, or refund of purchase price at the sole discretion of Texmate. Users shall determine the suitability of the product for the intended application before using, and the users assume all risk and liability whatsoever in connection therewith, regardless of any of our suggestions or statements as to application or construction. In no event shall Texmate's liability, in law or otherwise, be in excess of the purchase price of the product.

Texmate cannot assume responsibility for any circuitry described. No circuit patent or software licenses are implied. Texmate reserves the right to change circuitry, operating software, specifications, and prices without notice at any time.

TEXMATE INC

995 Park Center Drive • Vista, CA 92081-8397

Tel: 1-760-598-9899 • USA 1-800-839-6283 • That's 1-800-TEXMATE

Fax: 1-760-598-9828 • Email: sales@texmate.com • Web: www.texmate.com

Texmate has facilities in Japan, New Zealand, Taiwan, and Thailand. We also have authorized distributors throughout the USA and in 28 other countries.

For product details visit www.texmate.com

Local Distributor Address