



LEOPARD FAMILY

BL-40PSF

**Leopard Panel Meter
4 Digit 0.56" LEDs
in a 1/16 DIN CASE**



An economically smart meter relay with programmable scale factor and offset with isolated 4 to 20 mA output retransmission capability for measurement and control applications in a 96x48mm case.

General Features

- External transmitters or signal conditioners can be eliminated by direct connection of the sensor output to more than 38 Plug-in Input Signal Conditioners that include:
 - AC/DC Current – Pressure – Resistance
 - AC/DC Voltage – Process – *Temperature
 - Load Cell – Prototype – 4 to 20 mA

*See model BL-40H for higher accuracy digitally linearized thermocouple and RTD

- Optional isolated 16 bit analog output. User or factory scalable to 4 to 20 mA, 0 to 20 mA or 0 to 10 V across any desired digital span from ± one count to the full scale range of – 1999 to 9999 (12000 counts).
- Auto-sensing AC/DC power supply. For voltages between **85-265 V AC / 95-370 V DC (PS1)** or 15-48 V AC / 10-72 V DC (PS2).
- 24 V DC excitation is available to power external transmitters and 5 or 10 V DC excitation is available for resistance bridge type sensors such as Load Cells and Pressure Transducers.
- Standard red or optional green or super bright red 4-digit LED with display range –1999 to 9999 (12000 counts).
- Three annunciator LEDs provide front panel alarm status indication for up to three setpoints.
- One 10 Amp Form C and one 5 Amp Form A relay, or up to three 5 Amp Form A relays are available.
- When analog output is installed, one 10 Amp Form C or two 5 Amp Form A relays can be supported.
- Automatic intelligent averaging smooths noisy signals, while providing a fast display response to real level changes.

Software Features

- Three-button programming from the front panel (UP, DOWN and PROGRAM buttons).
- Three front panel selectable ranges.
- Front panel selectable four-level brightness control of digital display, and setpoint LEDs.
- Three programmable setpoints.
- Relay activation can be selected to occur above (HI) or below (LO) each setpoint.
- Hysteresis setting for all three setpoints. Delay on make and delay on break for SP1 and SP2.
- Peak and Valley. View and Reset.

Input Module Compatibility

LEOPARD FAMILY: More than 38 different Plug-in I-Series Modular Input Signal Conditioners are approved for Texmate's Leopard Family of meters. Some examples are shown on pages 10-12. See www.texmate.com for an up to date listing.



LEOPARD

Specifications

Input Specs:Depends on input signal conditioner
A/D Converter:.....14 bit single slope
Accuracy:.....±(0.05% of reading + 2 counts)
Temp. Coeff.:.....100 ppm/°C (Typical)
Warm up time:.....2 minutes
Conversion Rate:.....5 conversions per second (Typical)
Display:.....**4 digit 0.56" Red LED display (std),**
 0.56" Red, Green or Super Bright Red
 (optn). Range –1999 to 9999 counts.
Polarity:.....Assumed positive. Displays – negative
Decimal Selection:.....Front panel button selectable, X•X•X•X•
Positive Overage:..Top segments of digital display flash
Negative Overage:..Bottom segments of digital display flash
Relay Output:Three 5 Amp Form A relays or one 10 Amp
 Form C, and one 5 Amp Form A relay.
Analog Output:.....Isolated 16 bit user scalable mA or V
 OIC (mA out).....4-20 mA @ 0 to 500Ω max loop resistance
 OIV (volts out)..... 0-10 V DC @ 500 Ω or higher resistance
Power Supply:.....AC/DC Auto sensing wide range supply
PS1 (std)85-265 VAC / 95-370 VDC @ 2.5W max 3.2W
PS215-48 VAC / 10-72 VDC @ 2.5W max 3.2W
Operating Temp.:.....0 to 60 °C
Storage Temp.:.....–20 °C to 70 °C.
Relative Humidity:95% (non condensing)
Case Dimensions:.....1/16 DIN Bezel 96x24mm
 Depth behind bezel 122.2mm (4.83")
 Plus 12.7mm (0.5") for Right-angled
 connectors
Weight:.....7 oz, 9 oz when packed

Index

Case Dimensions. 14	Digital Span Selection for	Input Module Compatibility 1	Software Logic Tree 3
Component Layout 8-9	Analog Range Output 5	Input Module Component Glossary . 13	Specifications 1
Connector Pinouts 7	Functional Diagram. 7	Ordering Information. 16	Two Point Analog Output
Connectors 7	General Features. 1	Other Leopard Family Meters. . . . 15	Range Setting & Calibration 5
Controls and Indicators 2	Glossary of Programming Symbols 2	Pin Descriptions 7-8	
Decimal Point & Brightness Selection . 5	I-Series Input Signal	Setpoint Setting & Relay	
Digital Calibration Mode. 4	Conditioning Modules. 10-12	Configuration Mode 6	
Digital Calibration Procedure 4	Input Module Calibration Procedures . . 13	Software Features. 1	

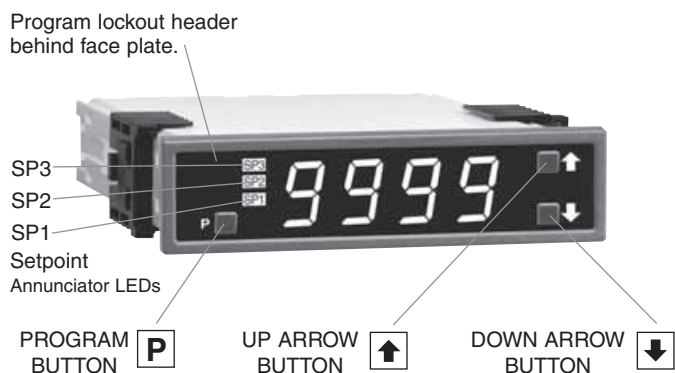

Front Panel Buttons

Program Button

The **P** button is used to move from one program step to the next. When pressed at the same time as the button, it initiates the **calibration mode**. When pressed at the same time as the button, it initiates the **setpoint setting mode**.

Up Button

When in the operational display, pressing the button alone, allows you to view and reset the Peak and Valley (Highest and Lowest Readings.)

When in the **calibration mode** or the **setpoint setting mode** the button is used to increase the value of the displayed parameter.

Down Button

When in the operational display, pressing the button alone, allows you to view, but not change, the setting of setpoint 1, 2 and 3.

When in the **calibration mode** or the **setpoint setting mode** the button is used to decrease the value of the displayed parameter.

Glossary of Programming Symbols

To explain software programming procedures, logic diagrams are used to visually assist in following the programming steps. The following symbols are used throughout the logic diagrams to represent the buttons and indicators on the meter:

Symbol	Explanation
	This symbol represents the OPERATIONAL DISPLAY.
	This is the PROGRAM button.
	This is the UP button.
	This is the DOWN button.
	When a button is shown, press and release it to go onto the next step in the direction indicated by the arrow. When two or more buttons are shown, each with an arrow, this indicates that there is a number of programming choices.
	When two buttons are shown side by side and enclosed by a dotted line, they must be pressed at the same time then released to go onto the next programming step.
	If the display is shown with XXXX it means the value displayed will be the previously set value. When a number is shown it indicates the initial factory default setting or a specific "example number".

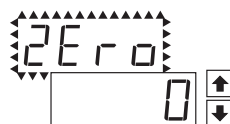

When two displays are shown together with bursts, this indicates that the display is toggling (flashing) between the name of the function and the value.

[Span]
[10000]

Text or numbers shown between square brackets in a procedure indicate the programming code name of the function or the value displayed on the meter display.

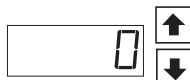

When the and buttons are shown together, the display value can be increased by pressing and releasing the button or decreased by pressing and releasing the button.

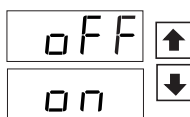

When the and buttons are shown with two displays, either display can be selected by pressing and releasing the or buttons.

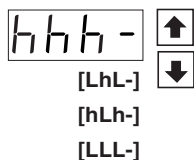

When there are more than two display selections they are shown in brackets below the first display and are also selectable by pressing and releasing the or buttons.

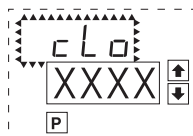

A dotted box indicates these functions are omitted or bypassed when the related hardware is not present

The BL-40PSF is an intelligent meter with a hierarchical software structure designed for easy programming and operation, as shown below in the software logic tree.

After the meter has been powered up, the four digits light up for three seconds and then settle to the operational display indicating the input signal.

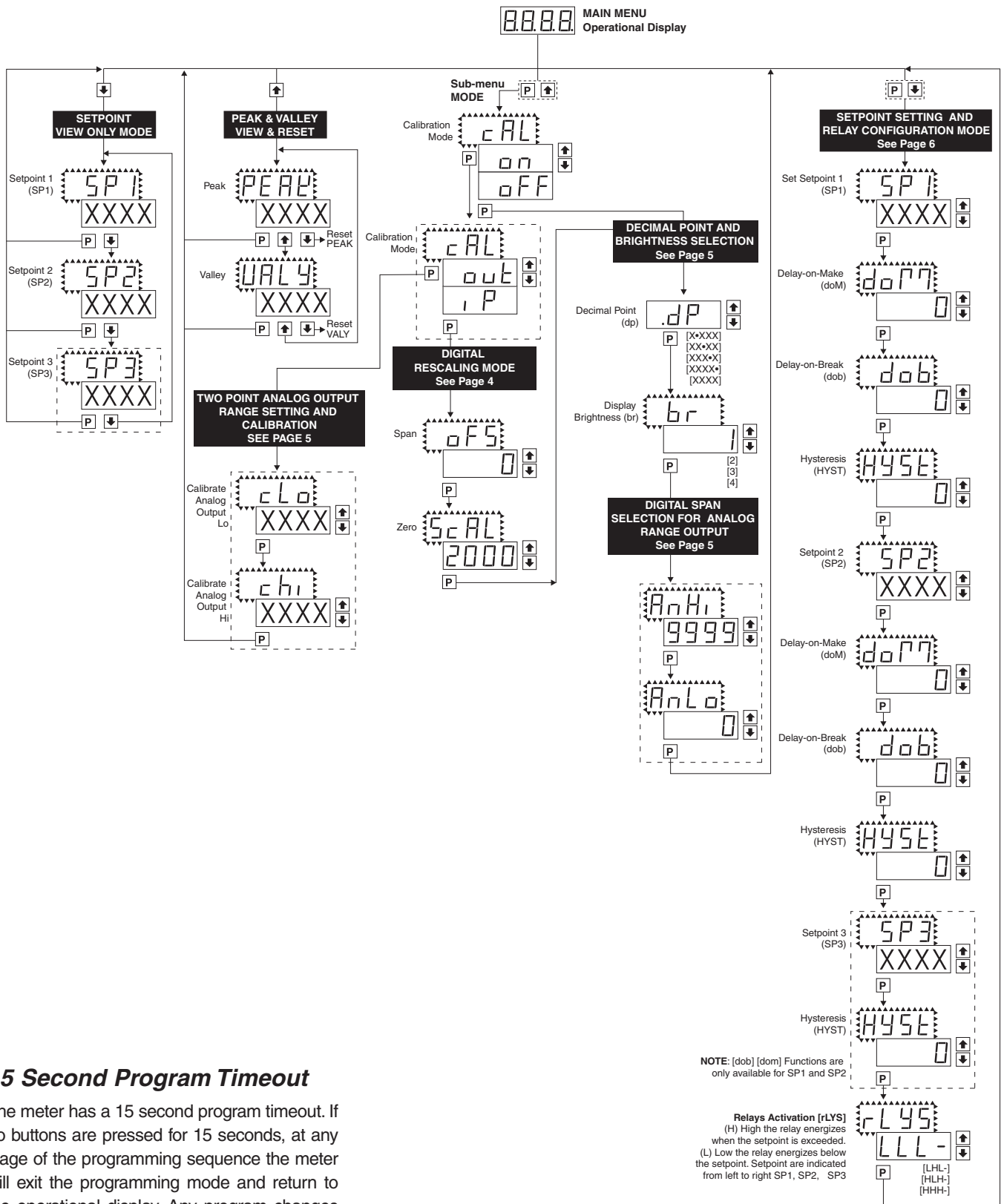

15 Second Program Timeout

The meter has a 15 second program timeout. If no buttons are pressed for 15 seconds, at any stage of the programming sequence the meter will exit the programming mode and return to the operational display. Any program changes that were made prior to pressing the **[P]** button in the preceding step will not be saved.

Digital Rescaling

The DL-40PSF meter may be rescaled without applying an external signal by changing the Offset and Scale factor.

Offset is the reading that the meter will display for a zero input. The Offset may be set to any value from -1999 to +9999. The default value of the Offset is 0

Scale factor is the gain of the meter. The displayed reading is directly proportional to the Scale factor. The default value of the scale factor is 2000, but it may be set to any value between -1999 and +9999.

For an input of 2V a calibrated meter will read 2000 with the default Scale factor of 2000, 3000 with a Scale factor of 3000 and 500 with a Scale factor of 500

If a linear scale is represented by $mx + b$, then the Scale Factor corresponds to the slope 'm' and the Offset corresponds to the intercept 'b'

The internal Signal Span is limited to 3 V DC between - 1 V DC to + 2 V DC. Outputs from an Input Signal Conditioning module that exceed these limits will cause the meter to indicate overrange.

Note: Most input signal conditioners have provisions for analog calibration and scaling. If the meter's digital Scale Factor is set to 2000 and Offset set to 0 then, any pre-calibrated signal conditioner with an output that does not exceed - 1 V to + 2 V, will read correctly in the meter without any further calibration.

Digital Rescaling Procedure

STEP A Enter the Calibration Mode

- 1) Press the **P** and **↑** buttons at the same time. Display toggles between [cAL] and [oFF].
- 2) Press the **↑** or **↓** button. Display changes from [oFF] to [on].
- 3) Press the **P** button. Display toggles between [cAL] and [out].

STEP B Select Between Calibration of Input or Output

Note: If the analog output option is not present, Step B is skipped and the program goes directly from Step A to Step C.

- 1) Press the **↑** or **↓** button to select the display toggling from [cAL] to [iP].
- 2) Press the **P** button. Display toggles between [oFFS] and the previous offset setting.

STEP C Set the Offset on the Digital Display

- 1) Using the **↑** and **↓** buttons, adjust the digital display to the desired offset. This is the reading that the meter will display for a zero input
- 2) Press the **P** button. Display toggles between [ScAL] and the previous Scale factor.

STEP D Set the Scale factor on the Digital Display

- 1) Using the **↑** and **↓** buttons, adjust the meter display to the desired Scale factor. The default value is 2000, for which a 2V input will read 2000. If the scale factor is changed the display will change proportionately. Therefore if the Scale factor is changed to 1000 then for the same 2V input the display would read 1000.
- 3) Press the **P** button.

The Digital Calibration Procedure Mode is Now Complete.

The menu branches to the DECIMAL POINT AND BRIGHTNESS SELECTION, (see page 5) and the display flashes [dP] and the previous decimal point selection.

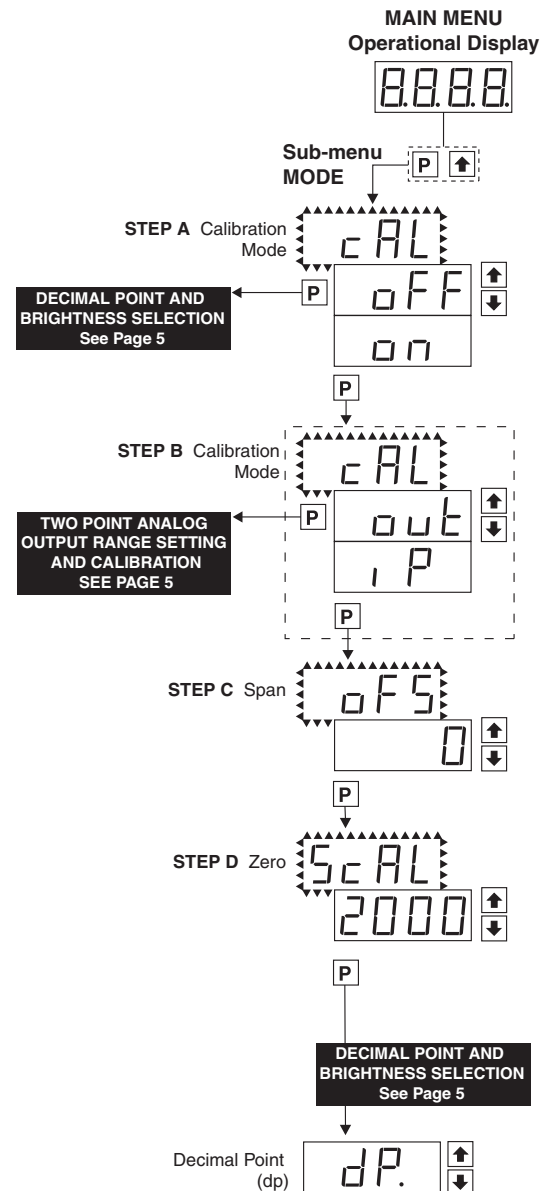

Two Point Analog Output Range Setting and Calibration

STEP A Enter the Calibration Mode

- 1) Press the **P** and **↑** buttons at the same time. Display toggles between [cAL] and [oFF].
- 2) Press the **↑** or **↓** button. Display changes from [oFF] to [on].
- 3) Press the **P** button. Display toggles between [cAL] and [out] input calibration.

Note: If at this point the display skips directly to toggle between [SPAN] and the previous [SPAN], the software is detecting that the optional analog output hardware is NOT installed.

STEP B Enter the Analog [oUT] Output Mode

- 1) Press the **P** button. Display toggles between [cLo] and an internal scale factor.

STEP C Set or Calibrate the [cLo] Low Analog Output Range

- 1) Select the voltage or current loop output header position on the output module. (See Component Layout on page 9).
- 2) Connect a multimeter to pins 8 and 9 on the output module. (See Rear Panel Pinouts on page 8). Using the **↑** and **↓** buttons, adjust the analog output to the desired low value as shown on the multimeter display. CLo may be adjusted to any value from -0.3 mA to 17 mA (mA output selected) or from -0.6 V to 8 V (volt output selected)
- 3) Press the **P** button. Display toggles between [Chi] and an internal scale factor.

STEP D Set or Calibrate the [chi] High Analog Output Range

- 1) Using the **↑** and **↓** buttons, adjust the analog output to the desired high value as shown on the multimeter display. chi may be adjusted to any value from 17 mA to 21 mA (mA output selected) or from 8 V to 10.3 V (volt output selected)
- 2) Press the **P** button. The display exits the calibration mode and returns to the operational display.

Note: Having established the Low and High range of the analog output, the digital span can now be selected which will set the two digital points between which the analog output will occur. (See Digital Span Selection below).

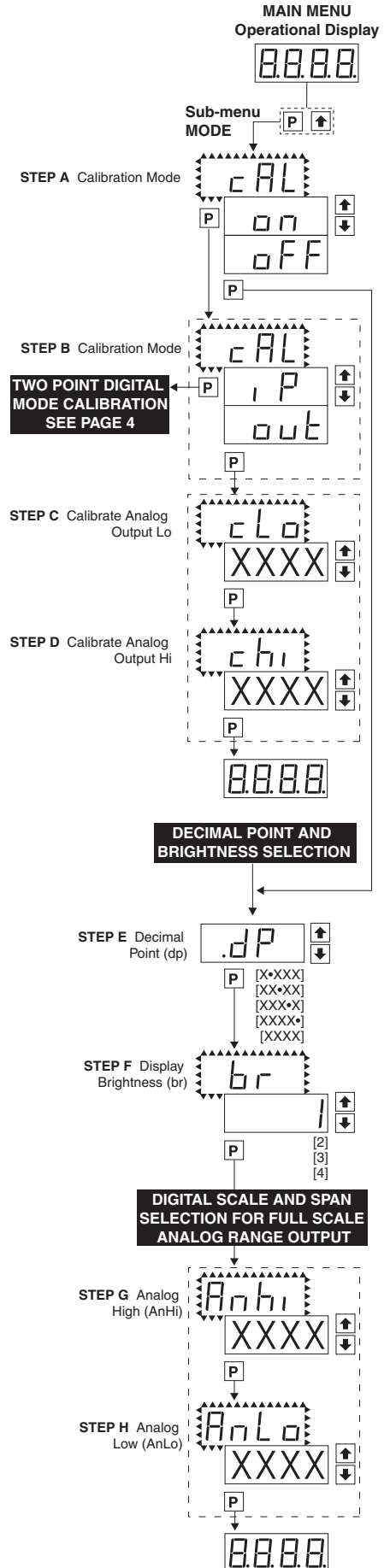

Decimal Point and Brightness Selection

STEP A Enter the Decimal Point and Brightness Mode Through the Sub Menu [cAL] [oFF]

- 1) Press the **P** and **↑** buttons at the same time. Display toggles between [cAL] and [oFF].
- 2) Press the **P** button. Display shows previous [dp] selection.

STEP E Set the Decimal Point

- 1) Using the **↑** and **↓**, adjust the display to the desired decimal point setting.
- 2) Press the **P** button. Display toggles between [Br] and the previous [Br] setting.

STEP F Set the Display Brightness

- 1) Using the **↑** and **↓** buttons, adjust the display to the desired brightness setting (4 is the brightest setting).
- 2) Press the **P** button. Display brightness changes to new setting and display toggles between [AnHi] and the previous [AnHi] setting.

Digital Span Selection for Analog Range Output

STEP G Setting the Digital Span Point for Analog High Output

- 1) Using the **↑** and **↓** buttons, adjust the display to the desired digital value which sets the point at which the selected analog high output range will occur.
- 2) Press the **P** button. Display toggles between [AnLo] and previous [AnLo] setting.

STEP H Setting the Digital Span Point for Analog Low Output

- 1) Using the **↑** and **↓** buttons, adjust the display to the desired digital value which sets the point at which the selected analog low output range will occur.
- 2) Press the **P** button. The display exits the calibration mode and returns to the operational display.

Note: Any two digital scale points from -1999 to 9999 can be selected. The digital scale points for analog high and analog low can be reversed for reversed 20-4 mA output. The span of the digital scale can be as small as two counts however small spans cause the 16 bit D to A to increment in stair case steps.

Setpoint Setting and Relay Configuration Mode

The following programming steps are required to enter the setpoint values and configure the relay functions in a meter with four relays using four setpoints. Generally if less than four relays are installed the software auto detects missing relays and deletes reference to them from the menu. In some cases setpoints without relays are operational for display only purposes.

STEP A Enter the Setpoint Mode

- 1) Press the **P** and **↓** buttons at the same time.
Display toggles between [SP1] and the previous [SP1] setting.

STEP B Set Setpoint 1 (SP1)

- 1) Using the **↑** and **↓** buttons, adjust the display to the desired SP1 value.
- 2) Press the **P** button. Display toggles between [doM] and the previous [doM] setting.

STEP C Set the SP1 Delay-on-Make (doM) Delay Time Setting

- 1) Using the **↑** and **↓** buttons, adjust the display to the desired [doM] value (0 to 9999 seconds). The reading must continuously remain in an alarm condition until this delay time has elapsed before the relay will make contact (energize).
- 2) Press the **P** button. Display toggles between [dob] and the previous [dob] setting.

STEP D Set the SP1 Delay-on-Break (dob) Delay Time Setting

- 1) Using the **↑** and **↓** buttons, adjust the display to the desired [dob] value (0 to 9999 seconds). The reading must continuously remain in a non-alarm condition until this delay time has elapsed before the relay will break contact (de-energize).
- 2) Press the **P** button. Display toggles between [HYSt] and the previous [HYSt] setting.

STEP E Set the Hysteresis Setting for Setpoint 1

- 1) Using the **↑** and **↓** buttons, adjust the display to the desired hysteresis [HYSt] value.
 - 2) Press the **P** button. Display toggles between [SP2] and the previous [SP2] setting.
- NOTE:** Half of the Hysteresis value selected is applied above and below the setpoint.

NOTE: Steps F, G, H and J have functionally the same procedure as steps B, C, D, and E shown above.

STEP F Set Setpoint 2 (SP2)

STEP G Set the SP2 Delay-on-Make (doM) Delay Time Setting

STEP H Set the SP2 Delay-on-Break (dob) Delay Time Setting

STEP I Set the Hysteresis Setting for Setpoint 2

- 1) Using the **↑** and **↓** buttons, adjust the display to the desired hysteresis [HYSt] value.
- 2) Press the **P** button. Display toggles between [SP3] and the previous [SP3] setting.

STEP J Set Setpoint 3 (SP3) (No [doM] or [dob])

- 1) Using the **↑** and **↓** buttons, adjust the display to the desired SP3 value.
- 2) Press the **P** button. Display toggles between [HYSt] and the previous [HYSt] setting.

STEP K Set the Hysteresis Setting for Setpoint 3

- 1) Using the **↑** and **↓** buttons, adjust the display to the desired hysteresis [HYSt] value.
- 2) Press the **P** button. Display toggles between [rLYS] and the previous relay setting.

STEP N Set Relay Activation mode [rLYS]

(H) High the relay energizes when the setpoint is exceeded. (L) Low the relay energizes below the setpoint. The setpoint is indicated from left to right SP1, SP2, and SP3.

- 1) Using the **↑** and **↓** buttons, adjust the reading on the display to the desired relay settings: [LLL-], [LHL-], [LLH-], [HHH-].
If only 2 relays installed [LH] [HL] [HH] [LL].
- 2) Press the **P** button.
The meter exits the setpoint mode and returns to the operational display.

The Setpoint Relay programming mode is now complete.

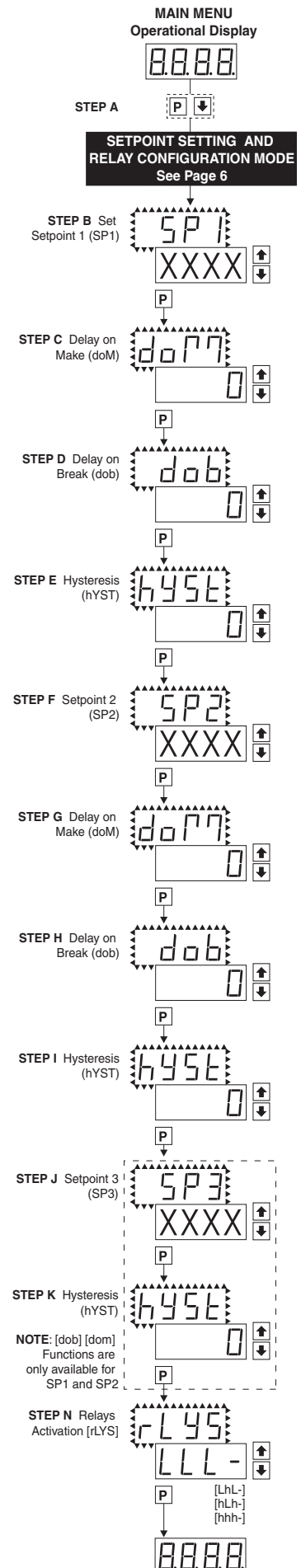

Functional Diagram

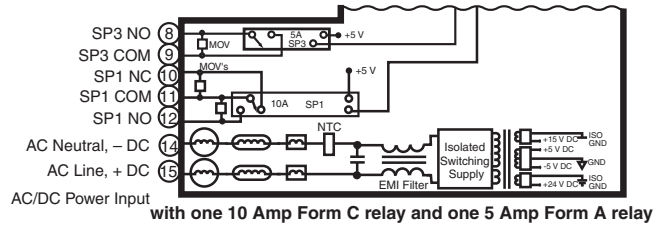
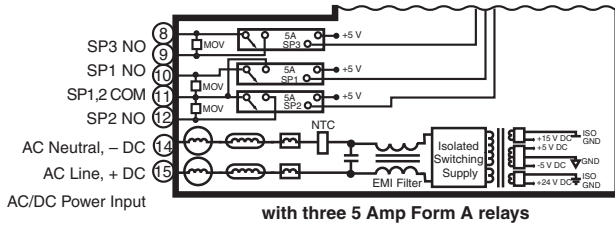
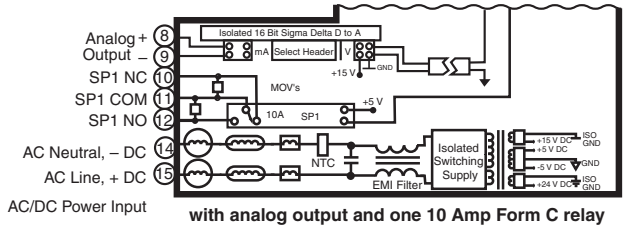
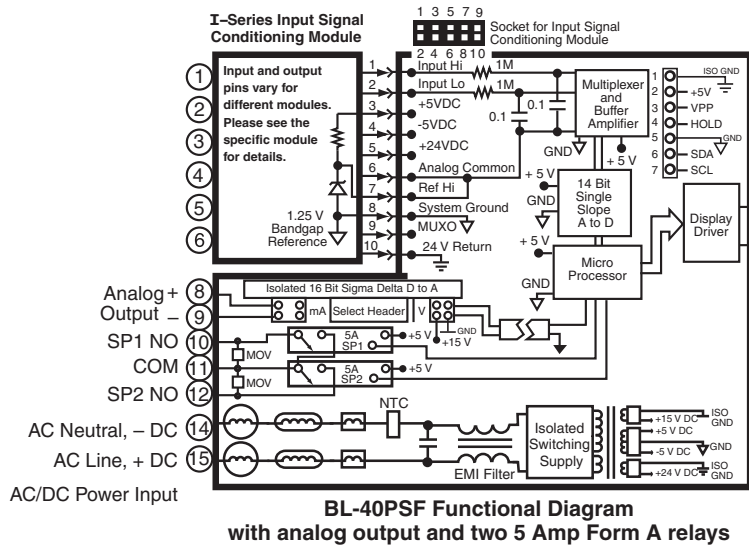

Connector Pinouts

This meter comes standard with screw terminal plug connections.

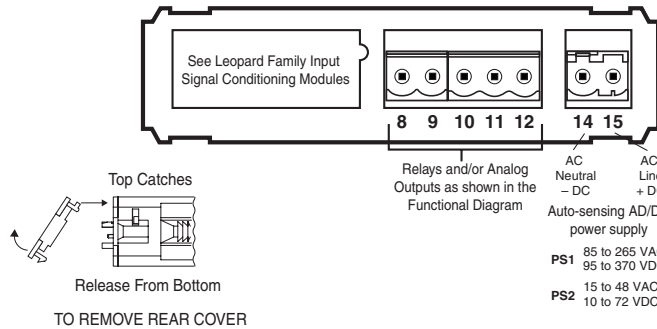

Connectors

This meter uses plug-in type screw terminal connectors for all input and output connections. The power supply connections (pins 14 and 15) have a unique plug and socket outline to prevent cross connection. The main board uses standard right-angled connectors.

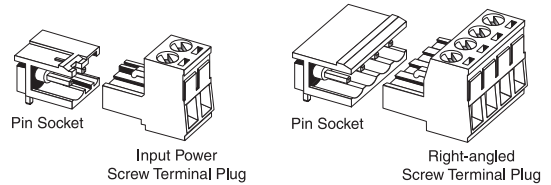

WARNING: AC and DC input signals and power supply voltages can be hazardous. Do Not connect live wires to screw terminal plugs, and do not insert, remove or handle screw terminal plugs with live wires connected.

Pin Descriptions

Input Signal – Pins 1 to 6

Pins 1 to 6 are reserved for the input signal conditioner. See the data sheet for the selected input signal conditioner.

Pins 8 to 12 – Relay and Analog Output Pins

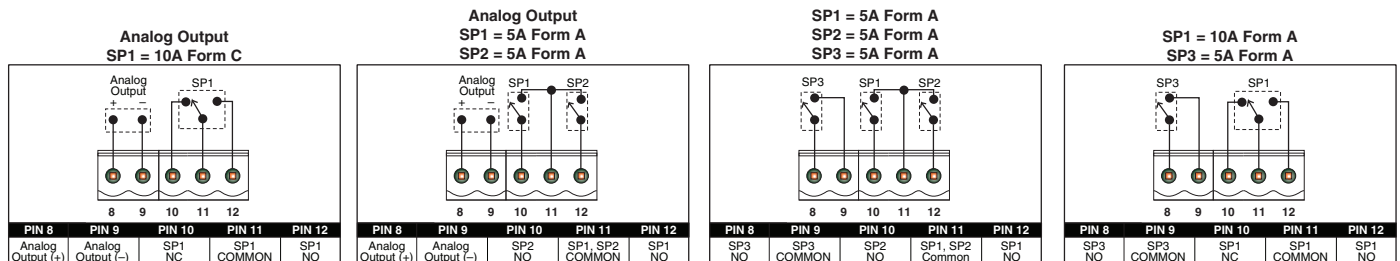

Pin Descriptions continued

Pins 14 and 15 – AC/DC Power Input

Auto sensing AC/DC power supply. For voltages between 85-265 VAC or 95-370 VDC (PS1).

Pin 14 & Pin 15 - AC/DC Power Input: These pins are the power pins of the meter and they only accept a special polarized screw terminal plug that can not be inserted into any other input socket. The standard meter has a auto sensing AC/DC power supply that operates from 85-265 VAC/95-370 VDC (PS1 Std). An optional isolated low voltage power supply that operates from 15-48 VAC/10-72 VDC (PS2) is also available.

Internal Header Pin out

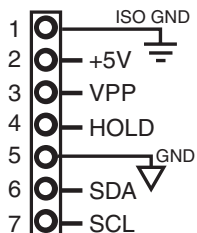

Internal header pins 1, 2, 3, 6, and 7 are for factory settings only. Not for external use!

4 HOLD. By connecting the HOLD pin to the GND pin, the displayed reading is frozen, however, A/D conversions continue. When the HOLD pin is disconnected from the GND pin, the correct reading is displayed.

5 GND. This pin is connected to the internal power supply ground.

Component Layout

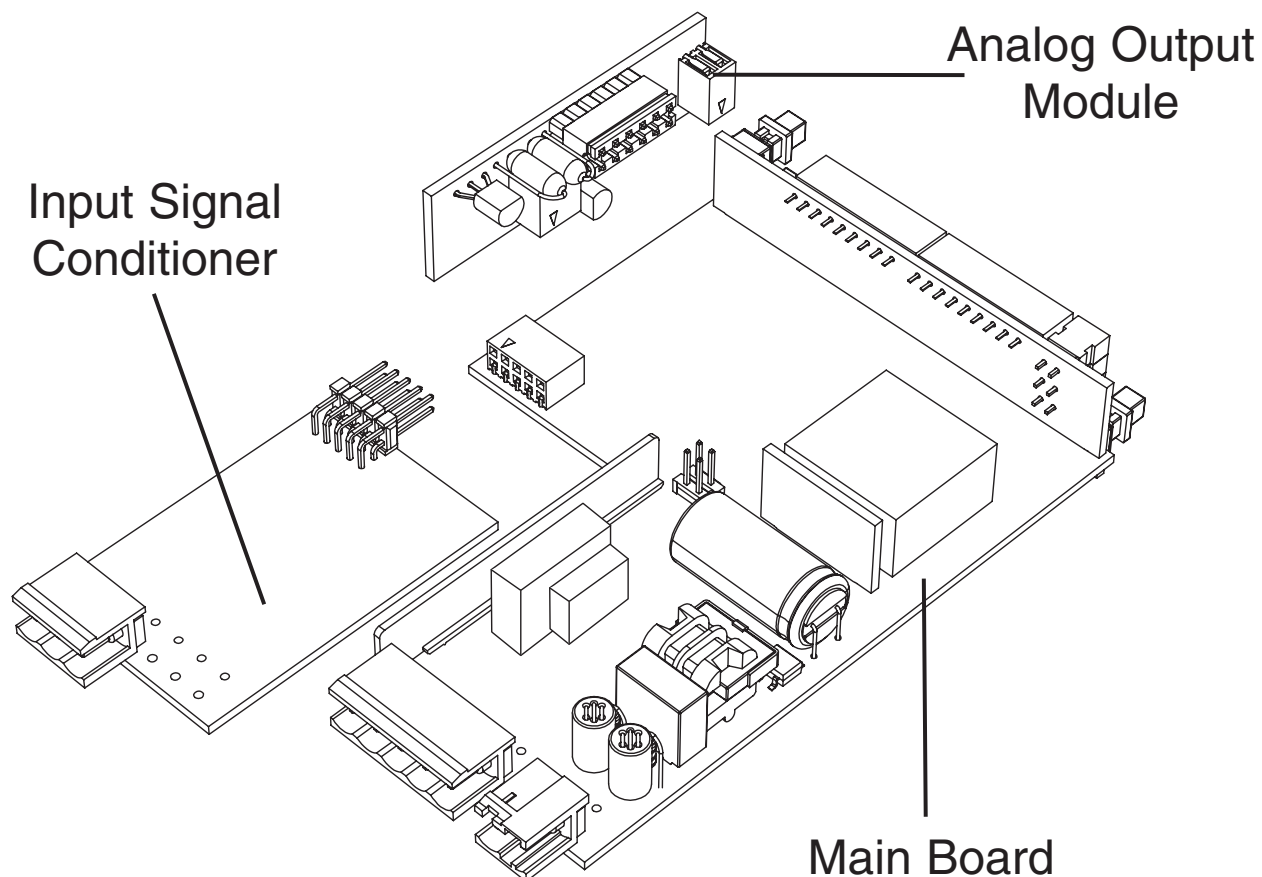

4 to 20 mA
(0 to 20 mA)
Selection Position

Analog Output
Selection Header

0 to 10 V DC
Selection
Position

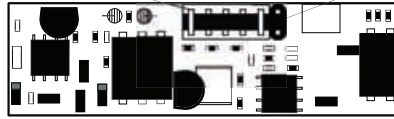

Optional Analog Output Module

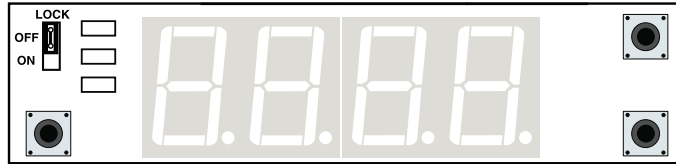

Display Board Front View

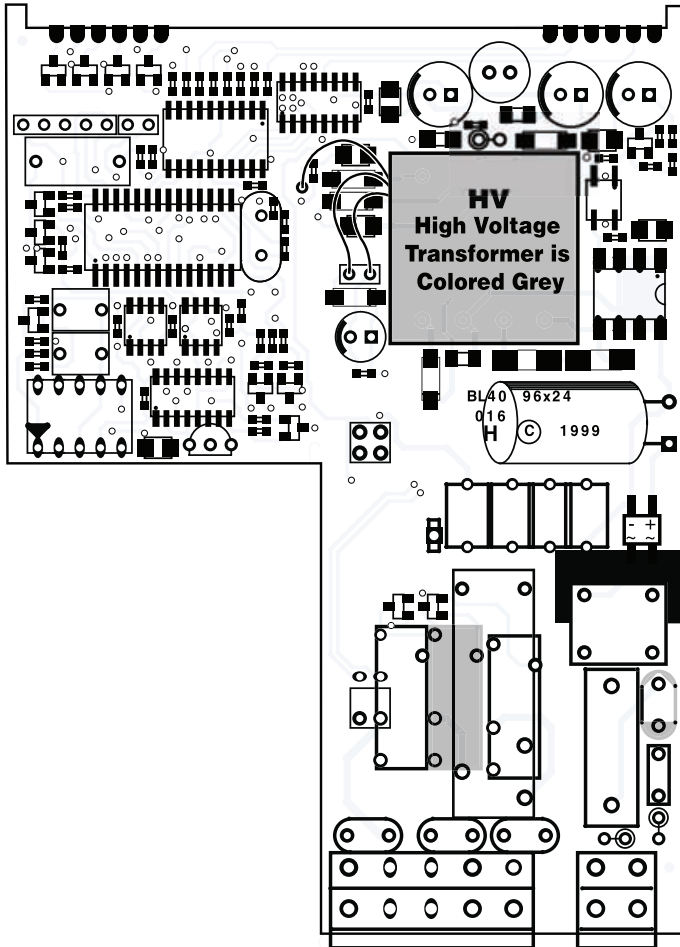

**PS1 High Voltage
Main Board**

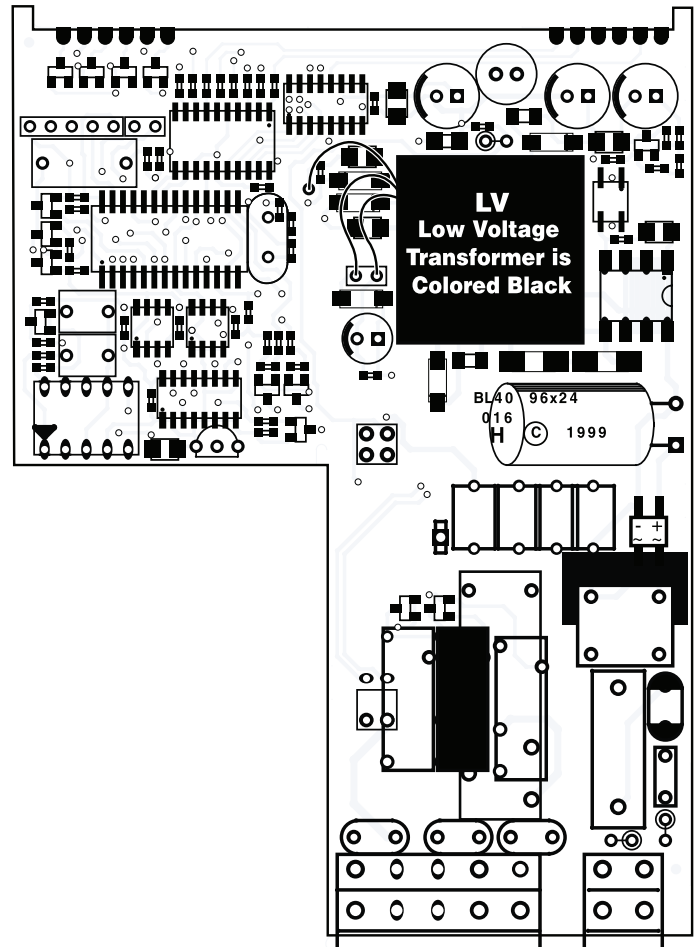

**PS2 Low Voltage
Main Board**









I-Series Input Signal Conditioning Modules

Many additional input modules are available and others are constantly being developed. Check with your local distributor or www.texmate.com for updated information.

Pre-calibrated **I-Series** input modules, that have span or zero potentiometers, can be interchanged between any **I-Series** compatible meter, without recalibration, because all of the analog scaling and reference circuitry is self-contained within the module. Where appropriate, all the standard ranges shown are designed to be header selectable by the user, and Texmate's unique SPAN ADJUST Header facilitates scaling to almost any required engineering unit. See Input Module Component Glossary and Calibration on pages 13 and 14. Also see Two Point Digital Calibration and Digital Calibration on page 4.

Unless otherwise specified Texmate will ship all modules pre-calibrated with factory preselected ranges and/or scalings as shown in **BOLD** type. Other pre-calibrated standard ranges or custom ranges may be ordered. Factory installed custom scaling and other custom options are also available (see Ordering Information, Special Options on last page).

Symbols Indicate Module Compatibility Within Meter Families

 TIGER Family	 LEOPARD Family	 LYNX Family
 LEOPARD Family	 LYNX Family	 TIGER Family
 LYNX Family	 TIGER Family	 LEOPARD Family
ALL MODELS	SOME MODELS	MODEL SPECIFIC



WARNING: AC and DC input signals and power supply voltages can be hazardous. Do Not insert, remove or handle modules with live wires connected to any terminal plugs.

IA06: AC Volts True RMS, 300/600V AC

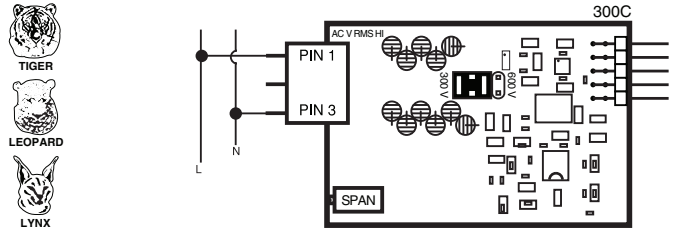

IA07: AC Volts True RMS, 200mV/2V/20V AC

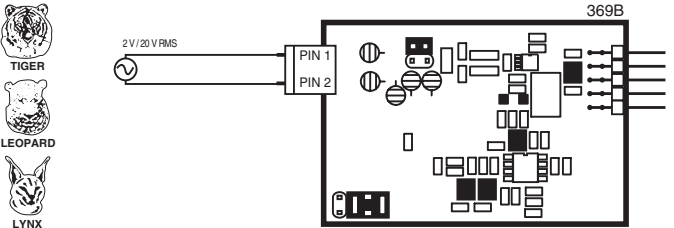

IA01: AC Volts Scaled RMS, 200/600V AC

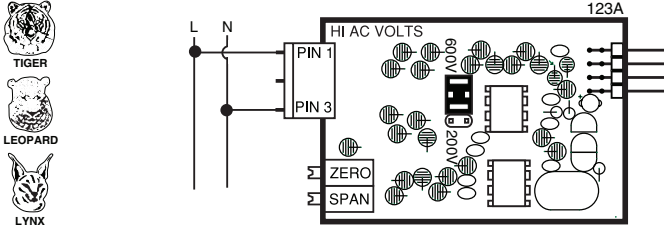

IA08: AC Milliamps True RMS, 2/20/200mA AC

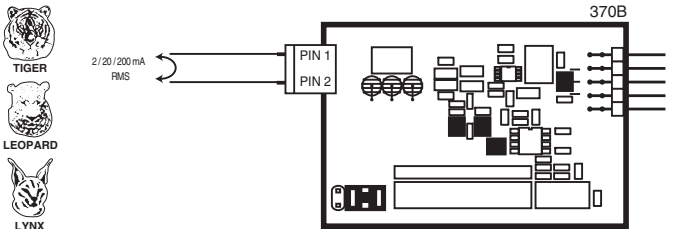

IA02: AC Volts Scaled RMS, 200mV/2V/20V AC

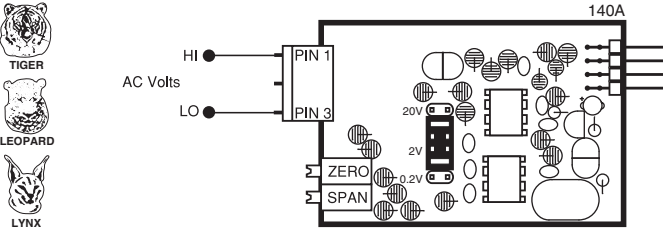

IA09: AC Amps True RMS, 1 Amp AC

IA11: AC Amps True RMS, 5 Amp AC

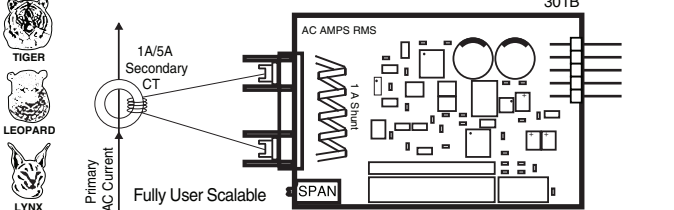

IA03: AC Milliamps Scaled RMS, 2/20/200mA AC

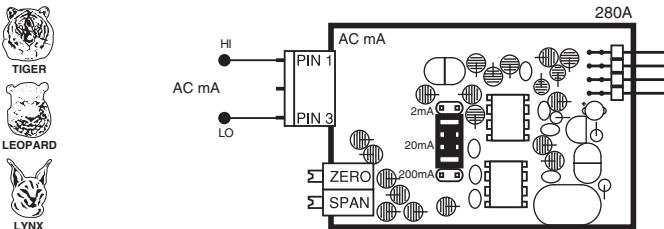

IA04: AC Amps Scaled RMS, 1 Amp AC

IA05: AC Amps Scaled RMS, 5 Amp AC

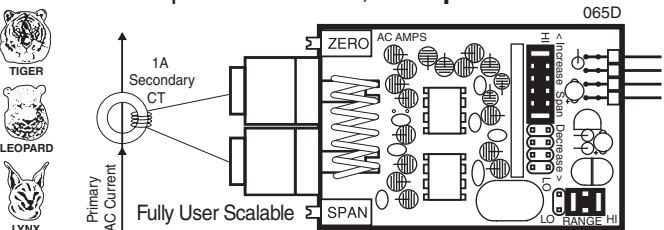

IA10: AC Millivolts, Scaled RMS, 100mV AC

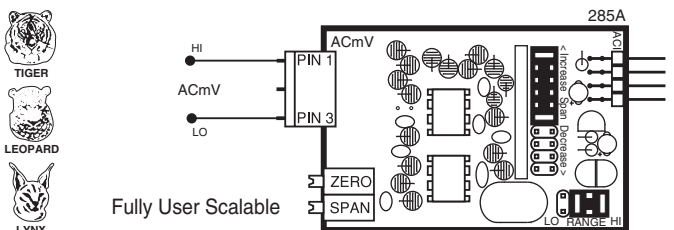

I-Series Input Signal Conditioning Modules

IA12: AC Millivolt RMS Sigma Delta

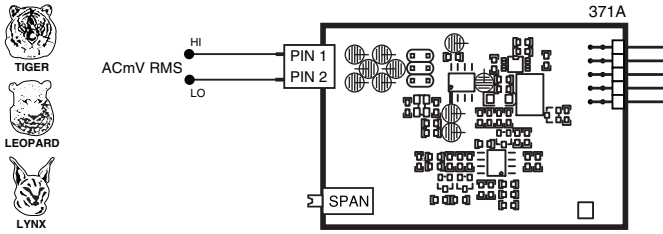

TIGER
LEOPARD
LYNX

ID07: DC Milliamps, 2/20/200mA DC with Offset and 24V Exc

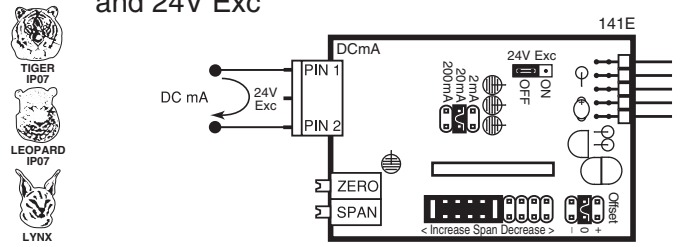

TIGER IP07
LEOPARD IP07
LYNX

ID01: DC Volts, 2/20/200V/Custom w/24V DC Exc

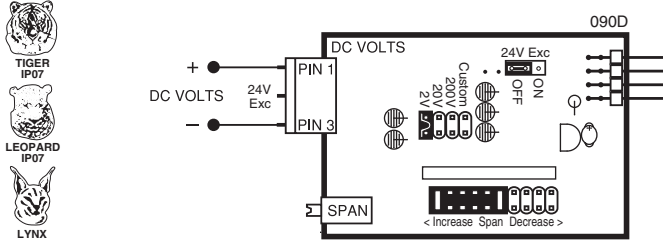

TIGER IP07
LEOPARD IP07
LYNX

IF02: Line Frequency

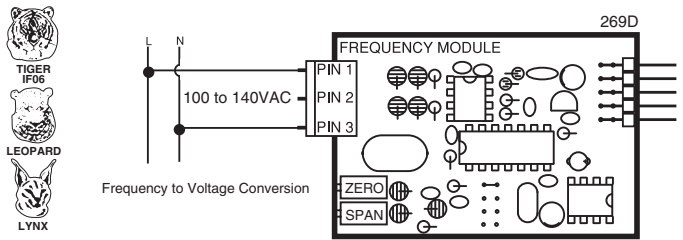

TIGER IP06
LEOPARD IP06
LYNX

ID02: DC Millivolts, 20/50/100/200mV DC w/24V DC Exc

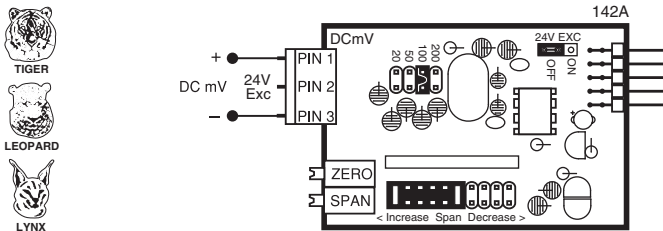

TIGER
LEOPARD
LYNX

IGYZ: Universal Direct Pressure (Absolute or Differential/Gage)
See below for ordering code options

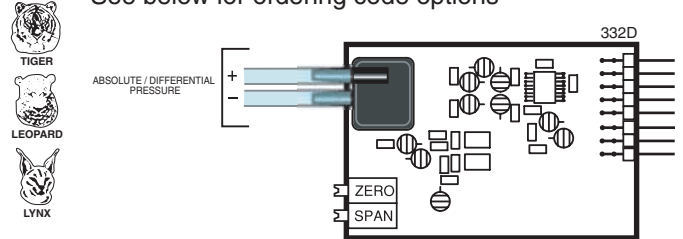

TIGER
LEOPARD
LYNX

ID03: DC Milliamps, 2/20/200mA DC w/24V DC Exc

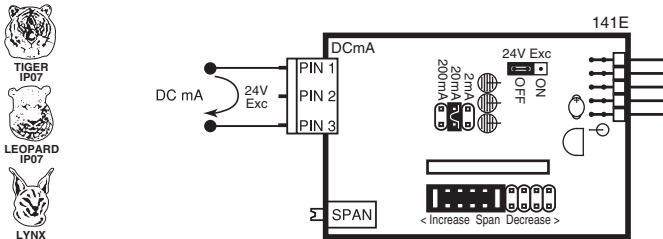

TIGER IP07
LEOPARD IP07
LYNX

Direct Pressure (IGYX, IGYG & IGYZ) Ordering Code Options

Sensor Range	CH1 Order Code	CH2 Order Code
1 psi Absolute	A	A
1 psi Differential	B	B
5 psi Absolute	C	C
5 psi Differential	D	D
15 psi Absolute	E	E
15 psi Differential	F	F
30 psi Absolute	G	G
30 psi Differential	H	H
100 psi Absolute	J	J
100 psi Differential	K	K

ID04: DC Amps, 5A DC

ID09: DC Amps, 1A DC

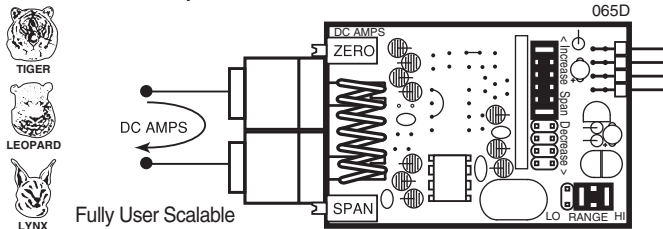

TIGER
LEOPARD
LYNX

IP01: Process Loop, 4-20mA

IP02: Process Loop, 4-20mA with 24VDC EXC

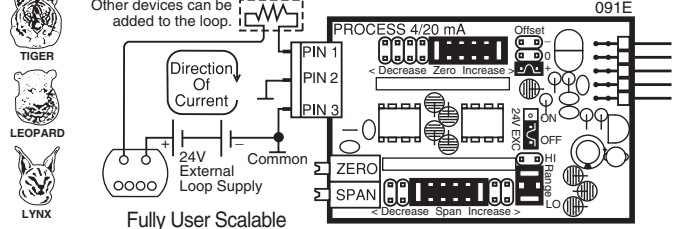

TIGER
LEOPARD
LYNX

ID05: DC Volts 2/20/200/Custom V DC with Offset and 24V Exc.

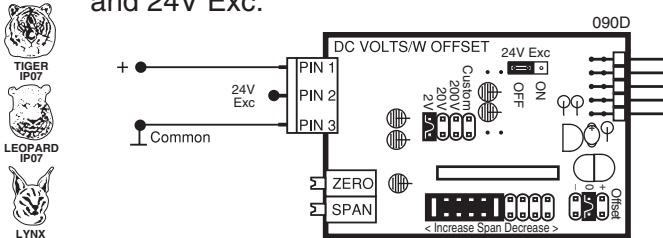

TIGER IP07
LEOPARD IP07
LYNX

IP03: Process Input, 1-5V DC with Offset, 24V Exc

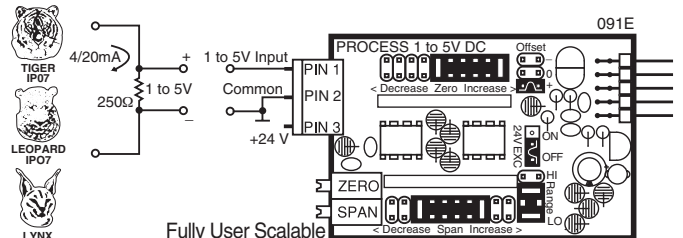

TIGER IP07
LEOPARD IP07
LYNX

I-Series Input Signal Conditioning Modules

IP07: Universal Process Input 2V/5V/10V/20V/200V/2mA/20mA/Custom

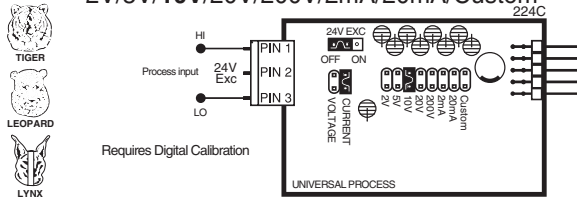

IP1: Prototype Board for Custom Design

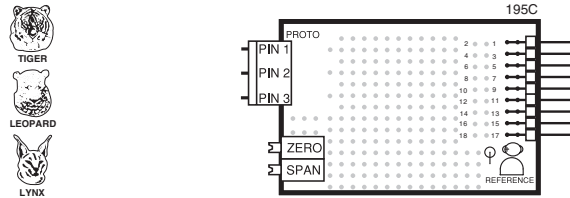

IR02: 3 wire Potentiometer 1KΩ min (0-F.S.)

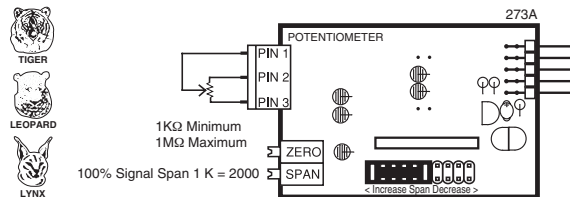

IR03: Linear Potentiometer 1KΩ min

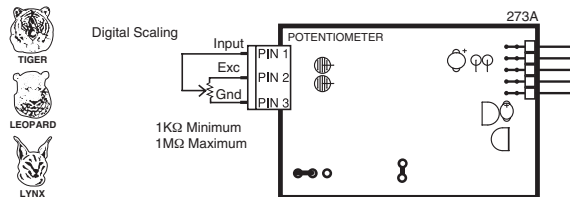

IR04: Resistance 2KΩ (Lynx only) IR05: Resistance 2KΩ (Leopard only)

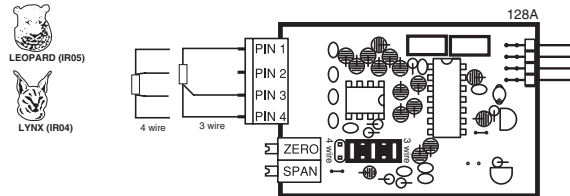

IS01: Strain Gage 5/10VDC Exc., 20/2mV/V, 4/6-wire

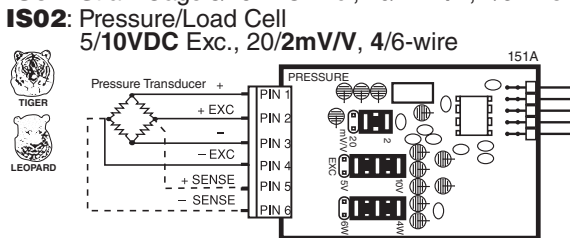

IS04: Pressure/Load Cell Ext Exc., 20/2mV/V, 4/6-wire

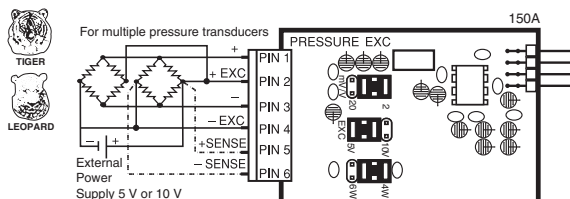

IS05: Pressure/Load Cell 20/2mV/V, 5/10V Exc 4-wire

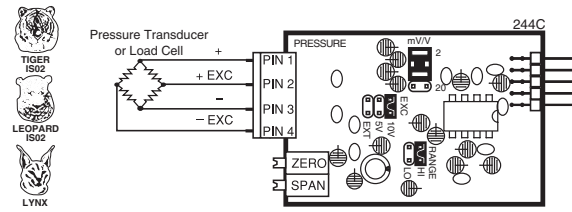

IS06: Pressure/Load Cell Ext Exc., 20/2mV/V, 4-wire

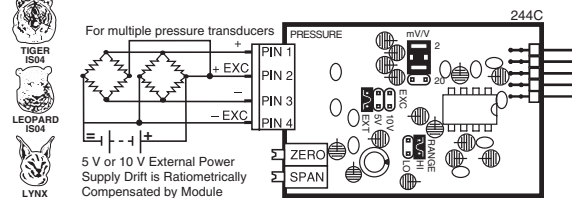

IS07: Pressure/Load Cell Ext Exc. High Impedance, 20/2mV/V, 4/6-wire

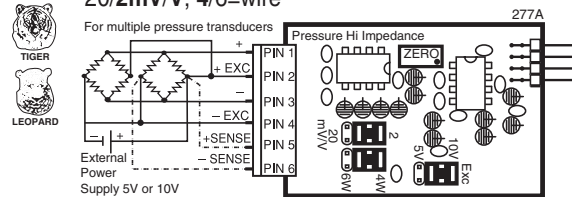

IT03: RTD, 100Ω Pt. 2/3/4-wire (-200 to 800°C) IT04: RTD, 100Ω Pt. 2/3/4-wire (-200 to 1470°F) IT05: RTD, 100Ω Pt. 2/3/4-wire (-199.9 to 199.9°F) IT14: RTD, 100Ω Pt. 2/3/4-wire (-199.9 to 199.9°C)

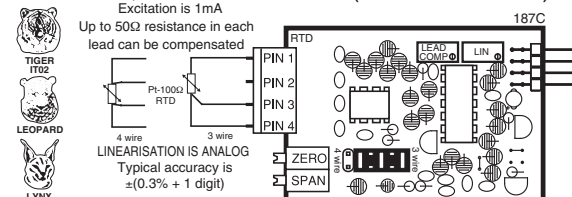

IT06: Thermocouple, J Type (0-1400 F) IT08: Thermocouple, J Type (0-760 C)

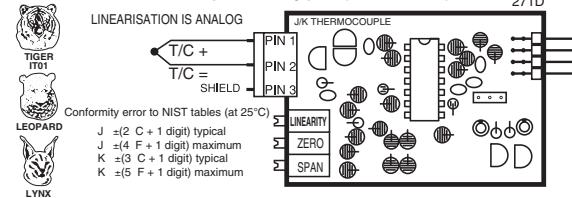

IT07: Thermocouple, K Type (0-1999 °F) IT09: Thermocouple, K Type (0-1260 °C)

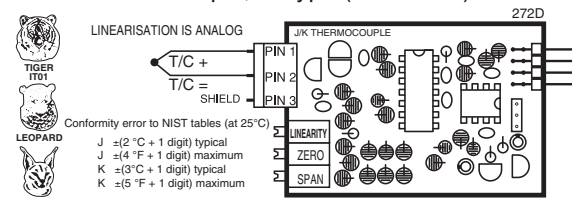

For higher accuracy digitally linearized RTD (P385 or P392) and Thermocouples (J/K/R and T), see the special Leopard Temperature meters DL-40H(1/8 DIN) and BL-40H(1/16 DIN) which use only two special thermocouple modules which are not compatible with regular Leopard Family meters.

- IT-10 Thermocouple J/K/R/T, °C/°F, 1°/0.1° resolution
User Selectable Accuracy ±0.05% + 2 digits.
- IT-11 RTD 100Ω Pt., 3/4 wire, °C/°F, 1°/0.1° resolution
User Selectable Accuracy ±0.05% + 2 digits.

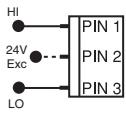

Input and Output Pins

On most modules Pin 1 is the Signal High input and Pin 3 is the Signal Low input. Typically Pin 2 is used for Excitation Voltage output.

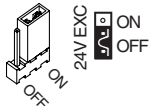

24V DC Output Header

On some modules this header enables a 24V DC 25mA (max) Excitation/Auxiliary output to be connected to Pin 2.

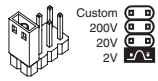

INPUT RANGE Header

Range values are marked on the PCB. Typically two to four positions are provided, which are selected with either a single or multiple jumper clip. When provided, a custom range position is only functional when the option has been factory installed.

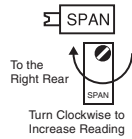

SPAN Potentiometer (Pot)

If provided, the 15 turn SPAN pot is always on the right side (as viewed from the rear of the meter). Typical adjustment is 20% of the input signal range.

SPAN ADJUST Header

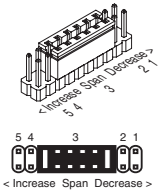

This unique five-position header expands the adjustment range of the SPAN pot into five equal 20% steps, across 100% of the input Signal Span. Any input Signal Span can then be precisely scaled down to provide any required Digital Display span from 1999 counts to 001 (one count).

SPAN Adjust Header position	1	2	3	4	5
SPAN Pot %	20%	20%	20%	20%	20%
Signal Span %	20%	40%	60%	80%	100%

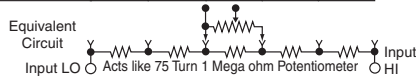

SPAN RANGE Header

When this header is provided it works in conjunction with the SPAN ADJUST Header by splitting its adjustment range into a Hi and a Lo range. This has the effect of dividing the adjustment range of the SPAN pot into ten equal 10% steps across 100% of the input Signal Span.

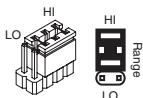

SPAN Adjust Header position	LO RANGE					HI RANGE				
	1	2	3	4	5	1	2	3	4	5
SPAN Pot %	10%	10%	10%	10%	10%	10%	10%	10%	10%	10%
Signal Span %	10%	20%	30%	40%	50%	60%	70%	80%	90%	100%

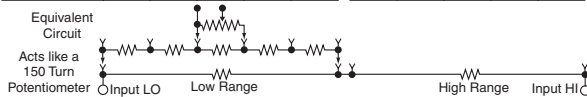

ZERO Potentiometer (Pot)

If provided, the ZERO pot is always to the left of the SPAN pot (as viewed from the rear of the meter). Typically it enables the input signal to be offset $\pm 5\%$ of full scale (-100 to +100 counts).

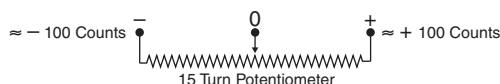

ZERO OFFSET RANGE Header

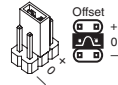

When provided, this three position header increases the ZERO pot's capability to offset the input signal, to $\pm 25\%$ of the digital display span. For example a Negative offset enables a 1 to 5V input to display 0 to full scale. The user can select negative offset, positive offset, or no offset (ZERO pot disabled for two step non-interactive span and offset calibration).

Negative Offset	No Offset	Positive Offset
Decreases Digital Reading	- 0 +	Increases Digital Reading
ZERO Pot% = -100% of Offset	No Offset	+ 100% of Offset
Offset Range = \ominus - 500 Counts	Zero Pot Disabled	\oplus + 500 Counts



ZERO ADJUST Header

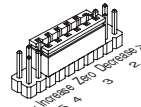

When this header is provided, it works in conjunction with the ZERO OFFSET RANGE Header, and expands the ZERO pot's offset capability into five equal negative steps or five equal positive steps. This enables virtually any degree of input signal offset required to display any desired engineering unit of measure.

ZERO Adjust Header position	NEGATIVE OFFSET					POSITIVE OFFSET				
	5	4	3	2	1	1	2	3	4	5
ZERO Pot %	-20%	-20%	-20%	-20%	-20%	+20%	+20%	+20%	+20%	+20%
Offset Range	-1200 or more counts					+1200 or more counts				



Input Module Analog Calibration

In addition to the analog calibration capabilities that enable many modules to be interchanged between different meters without loss of accuracy the Leopard Family of meters have enhanced Digital Calibration functions. See Page 4

Basic standard range calibration of direct reading modules that utilize either Auto Zero or a ZERO pot, an INPUT RANGE Header and or a SPAN pot.

- 1 If the module has an INPUT RANGE Header, reposition the jumper clip to select the desired input signal range.
- 2 Apply a zero input or short the input pins. The display will auto zero, or if the module has a ZERO pot, it should be adjusted until the display reads zero.
- 3 Apply a known input signal that is at least 20% of the full scale input range and adjust the SPAN pot until the display reads the exact input value. For negative inputs, Leopard Family Meters will display negative overrange at 50% of full scale range.
- 4 Decimal Points. The selection or positioning of decimal points has no effect on the calibration of the modules

Wide range scaling, in engineering units not requiring offsets, with modules that utilize auto-zero or a ZERO pot, a SPAN RANGE Header and or a SPAN ADJUST Header.

Texmate's unique SPAN ADJUST and SPAN RANGE Headers provide the circuit equivalent of an ultra-precision one megohm 75 or 150 turn potentiometer that can infinitely scale down any Input Signal SPAN to provide any full scale Digital Display Span from 1999 (counts) to 001 (one count).

If the module has an INPUT RANGE Header, and the required full

Input Module Calibration Procedures Continued

scale Digital Display Span (counts) is to be larger than the directly measured value of the input Signal Span, then the next lower range on the INPUT RANGE Header should be selected. The resulting over range Signal Span is then scaled down, by selecting the position of the SPAN RANGE Header and or the SPAN ADJUST Header, which will reduce the input Signal Span to a percentage, that the required Digital Display Span can be reached by calibration with the SPAN pot.

Example A: 0 to 10 V to read 0 to 1800 gallons.

Signal Span = 10V, Digital Display Span = 1800 counts

- 1 Select the 2 V INPUT RANGE Header position. This will provide a digital display of 1800 counts with an input of only 1.8 V which is $(1.8 \div 10) = 18\%$ of the examples 10 V Signal Span.
- 2 To scale down the Signal Span to 18% select the 20% Signal Span position on the SPAN ADJUST Header (position 1) or if the module has a SPAN RANGE Header, select (LO Range) and 20% Signal Span position on the SPAN ADJUST Header (position 2).
- 3 Apply a zero input or short the input pins. The display will auto zero, or if the module has a ZERO pot, it should be adjusted until the display reads zero.
- 4 Apply 10 V and adjust the SPAN pot until the display reads 1800.

Large offset scaling and calibration of process signal inputs with modules that utilize ZERO ADJUST Headers and or ZERO OFFSET RANGE Headers.

Texmate's unique ZERO OFFSET RANGE Header enables the use of a simple two step scaling and calibration procedure for those process signals that require large offsets. This eliminates the back and forth interaction, between zero and span settings, that is often required to calibrate less finely engineered products.

The first step is to set the ZERO OFFSET RANGE Header to the center position (No Offset) and scale down the Input Signal Span to a percentage that will enable calibration with the SPAN pot to reach the required Digital Display Span.

The second step is to set the ZERO ADJUST and or ZERO OFFSET RANGE Header to provide a positive or negative offset of sufficient counts that calibration with the ZERO pot will offset the Digital Display Span to produce the required digital reading.

Example B: 1 to 5 V to read -100 to 1500 °C.

Signal Span = 4V, Digital Display Span = 1600 counts

- 1 If the module has an INPUT RANGE Header the 2 V position should be selected. This will provide a digital display of 1600 counts for an input of 1.6 V which is $(1.6 \div 4) = 40\%$ of the examples 4 V signal span. To scale down the Signal Span to 40% select the 40% Signal Span position on the SPAN ADJUST Header (position 2).
- 2 If the module is a Process Input 1-5 V DC type, select the (Hi Range) position on the SPAN RANGE Header and the 100% Signal Span position on the SPAN ADJUST Header (position 5, max increase). This will provide a digital display of 1600 counts for an input of 4V which is 100% of the examples 4V Signal Span.
- 3 Set the ZERO OFFSET RANGE Header to the center position (no offset). Apply 1 V and adjust the SPAN pot until the display reads 400 . A 4V input would then read 1600 counts.
- 4 Set the ZERO OFFSET RANGE Header to the negative offset position. If the module has a ZERO ADJUST Header select the position that will provide a negative offset of ≈ -500 counts. Apply 1 V and adjust the ZERO pot until the display reads -100. Apply 5 V and check that the display reads 1500.

Example C: 4 to 20 mA to read 00.0 to +100.0%

Signal Span = 16 mA, Digital Display Span = 1000 counts.

- 1 The full scale Signal Span of the Process Input 4-20 mA modules is 0 to 20 mA for a full scale Digital Display Span of 0 to 2000 counts. This will provide a digital display of 1000 counts with an input of only 10 mA which is $(10 \div 16) = 62.5\%$ of the examples 16 mA signal span.
- 2 To scale down the Signal Span to 62.5% select the (Hi Range) Position on the Span Range Header and the 70% Signal Span position on the SPAN ADJUST Header (position 2).
- 3 Set the ZERO OFFSET RANGE Header to the center position (no offset). Apply 4 mA and adjust the SPAN pot until the display reads 250 . A 16 mA input would then read 1000 counts.
- 4 Set the ZERO OFFSET RANGE Header to the positive offset position. If the module has a ZERO ADJUST Header select the position that will provide a negative offset of ≈ -250 counts. Apply 4 mA and adjust the ZERO pot until the display reads 000. Apply 20 mA and check that the display reads 1000. Select decimal point XXX•X to display 00.0 to 100.0.

Case Dimensions

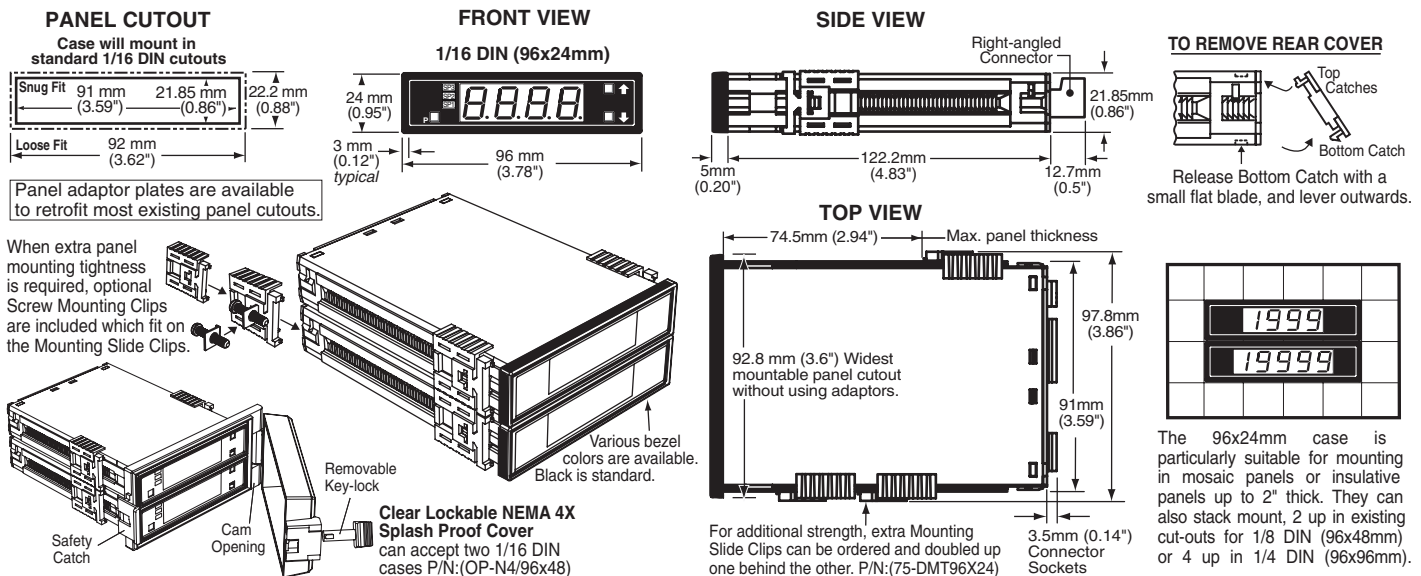



Leopard Family Meters and Bargraphs

INTERNATIONAL	
DIN	
CASES	
1/32	1/8
1/32	1/8

Smart, Programmable Bargraph Relays with Isolated 16 Bit 4-20 mA or 0-10 V Outputs

▼ **FL-B202Q**
Red or Green Display

9/64 DIN 36x144 mm (1.42"x5.69")

NEW!

▼ **FL-B101Q**
Red or Green Display for Left, Right and Center Bar
Tri-Color option for Center Bar only

3/32 DIN 24x144 mm (0.95"x5.69")

▼ **FL-B101D40** Programmable Tri Color
or Mono Color, Red or Green Display

3/32 DIN 24x144 mm (0.95"x5.69")

▼ **PL-B101D40** Shown with
Optional white
face plate. Black
is standard.

3/32 DIN 24x144 mm (0.95"x5.69")

▼ **BL-B51D40**
Red Display

1/16 DIN 24x96 mm (0.95"x3.78")

LEOPARD FAMILY FEATURES

- Smart 4 digit meters, tricolor and mono-color bargraphs
- Front-panel digital scaling, offset, and setpoints
- Bargraph can be independently scaled to a sensitivity of 100 counts full scale within any portion of the digital scale
- Over 38 different I-Series Input Signal Conditioners. For more info, please refer to the "I-Series Input Signal Conditioning Modules" catalog.
- 24 V DC excitation is available to power external 4-20 mA transmitters and 5 or 10 V DC excitation is available for resistance bridge type sensors
- Dual 10 & 5-amp relays, 4 relays total plus 16-bit analog output
- 1/16 DIN meters have one 10 Amp relay or two 5 Amp relays plus 16-bit analog output or an extra 5 Amp relay
- Auto-sensing AC/DC, wide range power supplies, 85-265 V AC / 95-370 V DC or 18-36 V AC / 9-60 V DC
- Quick, easy mounting into any panel thickness
- Direct flush mount into mosaic panels
- Optional NEMA 4X membrane touch screen face plates
- Optional NEMA 4X, IP65 clear polycarbonate lens covers
- Optional metal surround case for DL and FL meters.
- Standard plug-in screw terminal connectors are provided



▲ **FL-B101D40PS with horizontal face plate option**
Programmable Tri Color or Mono Color, Red or Green Display

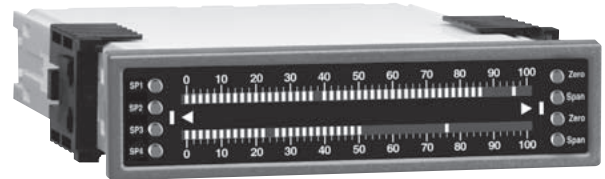

▲ **FL-B202Q horizontal face plate option**
Red or Green Display



▲ **DL-40 w/0.8" display option**



▲ **DL-40 Water Proof Membrane Touch-pad Option**



▲ **DL-40**

Ordering Information

BASIC MODEL # DISPLAY POWER SUPPLY INPUT MODULES ANALOG OUTPUT RELAY OUTPUT OPTIONS / ACCESSORIES

BL-40PSF — [] — [] — [] — [] — [] — OA []

Add to the basic model number the order code suffix for each standard option required. The last suffix is to indicate how many different special options and/or accessories that you may require to be included with this product.

Ordering Example: BL-40PSF-DR-PS1-IA01-OIC-R1-OA2, the 2 OA's are, CR-CHANGE and a 75-DMT96X24

► BASIC MODEL NUMBER

BL-40PSF . . . 96x24mm, Leopard, 4 Digit, Programmable Scale Factor

Standard Options for this Model Number

Order Code Suffix Description

► DISPLAY

DR . . . Red LED, 0.56 inch high
DB . . . Super-bright Red LED, 0.56 inch high
DG . . . Green LED, 0.56 inch high

► POWER SUPPLY

PS1 . . . 85 - 265VAC / 95 - 370VDC
PS2 . . . 18 - 48VAC / 10 - 72VDC

► INPUT MODULES (Partial List. See www.texmate.com)

Unless otherwise specified Texmate will ship all modules precalibrated with factory preselected ranges and/or scalings as shown in **BOLD** type.

IA01 . . . AC-Volts Scaled RMS, 200/**600V** AC
IA02 . . . AC-Volts Scaled RMS, 200mV/**2V**/20V AC
IA03 . . . AC-mA Scaled RMS, 2/**20**/200mA AC
IA04 . . . AC-Amps Scaled RMS, **0-1 Amp AC (0-100.00)**
IA05 . . . AC-Amps Scaled RMS, **0-5 Amp AC (0-100.00)**
IA06 . . . AC-Volts True RMS, 200/**600V** AC
IA07 . . . AC-Volts True RMS, 200mV/**2V**/20V AC
IA08 . . . AC-mA True RMS, 2/**20**/200mA AC
IA09 . . . AC-Amps True RMS, **0-1 Amp AC (0-100.00)**
IA10 . . . AC-Millivolt, Scaled RMS, **100mV AC**
IA11 . . . AC-Amps True RMS, **0-5 Amp AC (0-100.00)**
IA12 . . . AC-Millivolt, True RMS, **100mV AC**
ID01 . . . DC-Volts, **2/20/200V**/Custom w/24V DC Exc
ID02 . . . DC-Millivolt, 20/50/**100/200mV** DC w/24V DC Exc
ID03 . . . DC-Milliamper, 2/**20**/200mA DC w/24V DC Exc
ID04 . . . DC-Amps, **5A DC**
ID05 . . . DC-Volts **2/20/200**/Custom V DC w/Offset and 24V Exc
ID07 . . . DC-Milliamper, 2/**20**/200mA DC w/Offset and 24V Exc
ID09 . . . DC-Amps, **1A DC**
IF02 . . . Line Frequency, 50-500VAC, 199.9Hz, or optional 400Hz
IGYZ* . . . Universal Direct Pressure
*View the IG- Ordering Code on page 11 to determine the value for Y & Z (IGAZ to IGKZ)
IP01 . . . Process Loop, **4-20mA(0-100.00)**
IP02 . . . Process Loop, **4-20mA(0-100.00)** w/24VDC Exc
IP03 . . . Process Input, **1-5V DC(0-100.00)** w/Offset, 24V Exc
IP07 . . . Universal Process 2V/5V/**10V/20V/200V/2mA/20mA**/Custom
IPT1 . . . Prototype Board for Custom Design
IR02 . . . 3-Wire Potentiometer 1KΩ min (0-F.S.)
IR03 . . . Linear Potentiometer, 3-wire, 1KΩ min
IR05 . . . Resistance 2KΩ
IS01 . . . Strain Gage 5/10VDC Exc., 20/**2mV/V**, 4/6-wire
IS02 . . . Pressure 5/10VDC Exc., 20/**2mV/V**, 4/6-wire
IS04 . . . Pressure Ext Exc., 20/2mV/V, 4/6-wire
IS05 . . . Pressure/Load Cell 20/2mV/V, 5/10V Exc 4-wire
IS06 . . . Pressure/Load Cell Ext Exc., 20/2mV/V, 4-wire

IS07 . . . Pressure 20/2mV/V with High Impedance and External Excitation
IT03 . . . RTD, 100Ω Pt. 2/**3/4-wire (-200 to 800°C)**
IT04 . . . RTD, 100Ω Pt. 2/**3/4-wire (-200 to 1470°F)**
IT05 . . . RTD, 100Ω Pt. 2/**3/4-wire (-190.0 to 199.0°F)**
IT06 . . . Thermocouple, J Type (**0-1400 °F**)
IT07 . . . Thermocouple, K Type (**0-1999°F**)
IT08 . . . Thermocouple, J Type (**0-760 °C**)
IT09 . . . Thermocouple, K Type (**0-1260°C**)
IT14 . . . RTD, 100Ω Pt. 2/**3/4-wire (-199.0 to 199.0°C)**

► ANALOG OUTPUT*

OIC . . . Isolated analog 4-20mA (with a Max. Two-5A Form A Relays)
OIV . . . Isolated analog 0-10VDC (with a Max. Two-5A Form A Relays)
*Note: When either of the Analog Output options is installed, only the R1, R2 and R11 Relay Output options can be co-installed (see below).

► RELAY OUTPUT

R1 . . . Single 5A Form A Relay
R2 . . . Dual 5A Form A Relays
R3 . . . Three 5A Form A Relays; SP1 & SP2 common**
R11 . . . Single 10A Form C Relay
R16 . . . Single 10A Form C & Single 5A Form A Relays**
**R3 & R16 cannot be co-installed with Analog Output options.

Special Options and Accessories (OA's)

Part Number Description

► SPECIAL OPTIONS (Specify Inputs or Outputs & Req. Reading)

CR-CHANGE Calibrated Range Change to another Standard Range
CS-L/40 Custom Scaling within any Std. or Custom Selectable Range
CSR-L/40 Custom Selectable Range Installation or Modification
CSS-L/40 Custom Special Scaling beyond the Standard Range
COA-L/SINGLE Custom Output - Special Scaling of Analog Output
COR-L/RELAY Custom Output - Relays Installed in Non-Standard Locations
CCP-L/SETUP NRC to Set-up Custom Configuration - Functions, Codes
CCP-L/INSTL Factory Installation - Custom Configuration

► ACCESSORIES (Specify Serial # for Custom Artwork Installation)

75-DMT96X24 Side Slide Brackets (2 pc) - extra set, extra strength
75-DBBZ96X24 Extra Black Bezel for 96x24mm Case
ART-FS-S/D/C NRC for artwork & set-up Faceplate/Desc/Co.Logo
ART-FS-S/D NRC for artwork & set-up Faceplate/Desc
ART-FS-001 Install Custom Faceplate per meter - 1 color
93-PLUG2P-DP Extra Screw Terminal Conn., 2 Pin Power Plug
93-PLUG2P-DR Extra Screw Terminal Conn., 2 Pin Plug
93-PLUG3P-DR Extra Screw Terminal Conn., 3 Pin Plug
93-PLUG4P-DR Extra Screw Terminal Conn., 4 Pin Plug
DN.CAS96X24L Extra Complete 96x24mm Case with bezel
OP-MTLCLIP Screw Mounting Clips (2 pc) to screw tighten slide brackets
75-DTP96X24 Black Metal Trim Plate (96x24mm Case) 1 Meter
75-DTP2X9624 Black Metal Trim Plate (96x24mm Case) 2 Meters
75-DTP3X9624 Black Metal Trim Plate (96x24mm Case) 3 Meters
Many other options and accessories are available. See full price list for more details.
Prices subject to change without notice.

WARRANTY

Texmate warrants that its products are free from defects in material and workmanship under normal use and service for a period of one year from date of shipment. Texmate's obligations under this warranty are limited to replacement or repair, at its option, at its factory, of any of the products which shall, within the applicable period after shipment, be returned to Texmate's facility, transportation charges pre-paid, and which are, after examination, disclosed to the satisfaction of Texmate to be thus defective. The warranty shall not apply to any equipment which shall have been repaired or altered, except by Texmate, or which shall have been subjected to misuse, negligence, or accident. In no case shall Texmate's liability exceed the original purchase price. The aforementioned provisions do not extend the original warranty period of any product which has been either repaired or replaced by Texmate.

USER'S RESPONSIBILITY

We are pleased to offer suggestions on the use of our various products either by way of printed matter or through direct contact with our sales/application engineering staff. However, since we have no control over the use of our products once they are shipped, NO WARRANTY WHETHER OF MERCHANTABILITY, FITNESS FOR PURPOSE, OR OTHERWISE is made beyond the repair, replacement, or refund of purchase price at the sole discretion of Texmate. Users shall determine the suitability of the product for the intended application before using, and the users assume all risk and liability whatsoever in connection therewith, regardless of any of our suggestions or statements as to application or construction. In no event shall Texmate's liability, in law or otherwise, be in excess of the purchase price of the product.

Texmate cannot assume responsibility for any circuitry described. No circuit patent or software licenses are implied. Texmate reserves the right to change circuitry, operating software, specifications, and prices without notice at any time.



995 Park Center Drive • Vista, CA 92081-8397

Tel: 1-760-598-9899 • USA 1-800-839-6283 • That's 1-800-TEXMATE

Fax: 1-760-598-9828 • Email: sales@texmate.com • Web: www.texmate.com

Texmate has facilities in Japan, New Zealand, Taiwan, and Thailand. We also have authorized distributors throughout the USA and in 28 other countries.

For product details visit www.texmate.com

Local Distributor Address