



LEOPARD FAMILY

BL-B51D40

Leopard Bargraph Meter
51 LED Segments
in a 1/16 DIN Case



A red, 51 segment bargraph with a 4-digit LED digital display for monitoring, measurement and control applications mounted in a 24x96mm case.

General Features

- External transmitters or signal conditioners can be eliminated by direct connection of the sensor output to more than 38 Plug-in Input Signal Conditioners that include:
 - AC/DC Current – Pressure – Resistance
 - AC/DC Voltage – Process – Temperature
 - Load Cell – Prototype – 4 to 20 mA
- 24 V DC excitation is available to power external transmitters and 5 or 10 V DC excitation is available for resistance bridge type sensors such as Load Cells and Pressure Transducers.
- A red, 51 segment high brightness bargraph.
- Red 4-digit LED display with a range of 1999 to 9999 (12000 counts).
- Front panel LED annunciators provide indication of setpoint status.
- Two 10 Amp Form C and two 5 Amp Form A relays available for the BL-B51D40.
- Auto-sensing AC/DC power supply. For voltages between **85-265 V AC/95-370 V DC (PS1)**.
- Provision for external DIM switch to reduce the brightest display setting by 50%.
- Automatic intelligent averaging smooths noisy signals, while providing a fast display response to real level changes.

Software Features

- The bargraph can display, full scale, any desired portion of the digital reading.
- Bargraph center zero function.
- Four programmable setpoints.
- Setpoint 1 has delay-on-make and delay-on-break plus a special "pump on pump off" mode that creates a Hysteresis Band between SP1 and SP2.
- Relay activation can be selected to occur above (hi) or below (Lo) each setpoint.
- Digital display blanking.
- Decimal point setting.
- Four-level brightness control of the bargraph and digital display.

Input Module Compatibility

LEOPARD FAMILY: More than 40 different Plug-in **I-Series** Input Signal Conditioners are approved for Texmate's Leopard Family of meters. Some examples are shown on pages 12 - 13. See www.texmate.com for an up to date listing.



LEOPARD

Specifications

Input Specs:Depends on Input signal conditioner
A/D Converter:14 bit single slope
Accuracy:±(0.05% of reading + 2 counts)
Temp. Coeff.:100 ppm/°C (Typical)
Warm up time:2 minutes
Conversion Rate:3 to 16 conversions per second
Display:4 digit 0.31" Red LED display (std).
Polarity:Assumed positive. Displays -ve sign.
Decimals:User programmable
Positive Overrange:.....Bargraph and top segments of digital display flash.
Negative Overrange: ..First segment of bargraph and bottom segments of digital display flash.
Display Range:.....-1999 to 9999 counts - 101 segment digital display
 0 to 101 segments on bargraph
Relay Output:Two 5A Form A relays.
Power Supply:AC/DC Auto sensing wide range supply
 85-265V AC / 95-370V DC@3W
Operating Temp.:0 to 60°C
Storage Temp:-20°C to 70°C.
Relative Humidity:95% (non condensing)
Case Dimensions: 1/16 DIN, Bezel: 96x24mm (3.78" x 0.95"),
 Depth behind bezel 122.2 mm (4.83")
 Plus 12.7mm (0.5") for Right-angled conn.
Weight:6.5 oz., 8.5 oz when packed.

Index

Bargraph Center Point Display Mode Selection . . .6	Digital Span Selection for Analog Range Output . .6	Setpoint Setting & Relay Configuration Mode . . .8
Case Dimensions7	Functional Diagram10	Software Features1
Component Layout10	General Features1	Software Logic Tree3
Connector Pinouts11	I-Series Input Signal Conditioning Modules . .12-13	Specifications1
Connectors11	Input Module Calibration Procedures15	Two Point Analog Range Setting & Calibration . . .7
Controls and Indicators2	Input Module Component Glossary14	Two Point Digital Calibration Mode4
Custom Faceplates and Scales9	Ordering Information16	
Decimal Point and Brightness Selection5	Pin Descriptions10	
Digital Span Selection for Display5	Programming Conventions2	

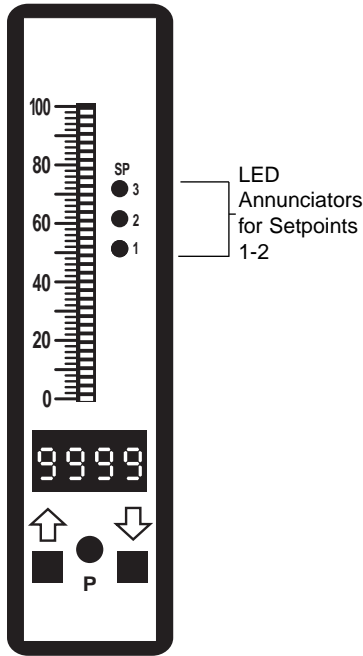

Display with Faceplate and Bezel

calibration mode. When pressed at the same time as the button, it initiates the **setpoint setting mode**.

Up Button

When in the operational display, pressing the button alone, allows you to view, but not change, the setting of Setpoint SP1.

When in the **calibration mode** or the **setpoint setting mode** the button is used to increase the value of the displayed parameter.

Down Button

When in the operational display, pressing the button alone, allows you to view, but not change, the setting of setpoint SP2.

When in the **calibration mode** or the **setpoint setting mode** the button is used to decrease the value of the displayed parameter.

Front Panel LED Display

Annunciator LEDs

The annunciator LEDs indicate the alarm status. They are labeled from bottom to top: SP1, SP2, SP3, SP4.

Digital LED Displays

The digital LED displays are used to display the meter input signal readings. They also display the programming settings during programming.

Setpoint Indication

The position of setpoints on the bargraph display are indicated by an ON or OFF segment dependent on the bargraph display being above or below the setpoint.

Front Panel Buttons

Program Button

The button is used to move from one program step to the next. When pressed at the same time as the button, it initiates the

Programming Conventions

To explain software programming procedures, logic diagrams are used to visually assist in following the programming steps. The following symbols are used throughout the logic diagrams to represent the buttons and indicators on the meter:



This symbol represents the OPERATIONAL DISPLAY.



This is the PROGRAM button.



This is the UP button.



This is the DOWN button.

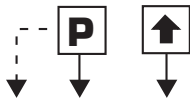

When a button is shown, press and release it to go onto the next step in the direction indicated by the arrow. When an alternative dotted line is shown, this indicates that an alternative logic branch will be followed when a particular option is present.



When two buttons are shown side by side and enclosed by a dotted line, they must be pressed at the same time then released to go onto the next programming step.



If an X appears through a digit, it means that any number displayed in that digit is not relevant to the function being explained.



When the and buttons are shown together, the display value can be increased by pressing and releasing the button or decreased by pressing and releasing the button.

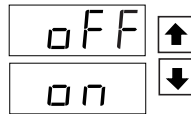

When the and buttons are shown with two displays, either display can be selected by pressing and releasing the or buttons.

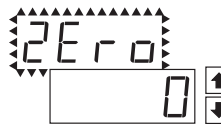

When two displays are shown together with bursts, this indicates that the display is toggling (flashing) between the name of the function and the value.



Text or numbers shown between square brackets in a procedure indicate the programming code name of the function or the value displayed on the meter display.

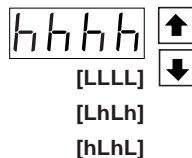

When there are more than two display selections they are shown in brackets below the first display and are also selectable by pressing and releasing the or buttons.

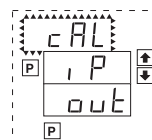

A dotted line enclosing an entire logic diagram indicates that programming branch will appear only when a particular option is present.

Software Logic Tree

This is an intelligent bargraph meter with a hierarchical software structure designed for easy programming and operation, as shown below in the software logic tree.

Software Version is Displayed on Power-up

When power is applied, all segments of the bargraph and digital display light up for 3 seconds. The version number of the installed software is then displayed for 2 seconds, after which, the operational display indicates the input signal.

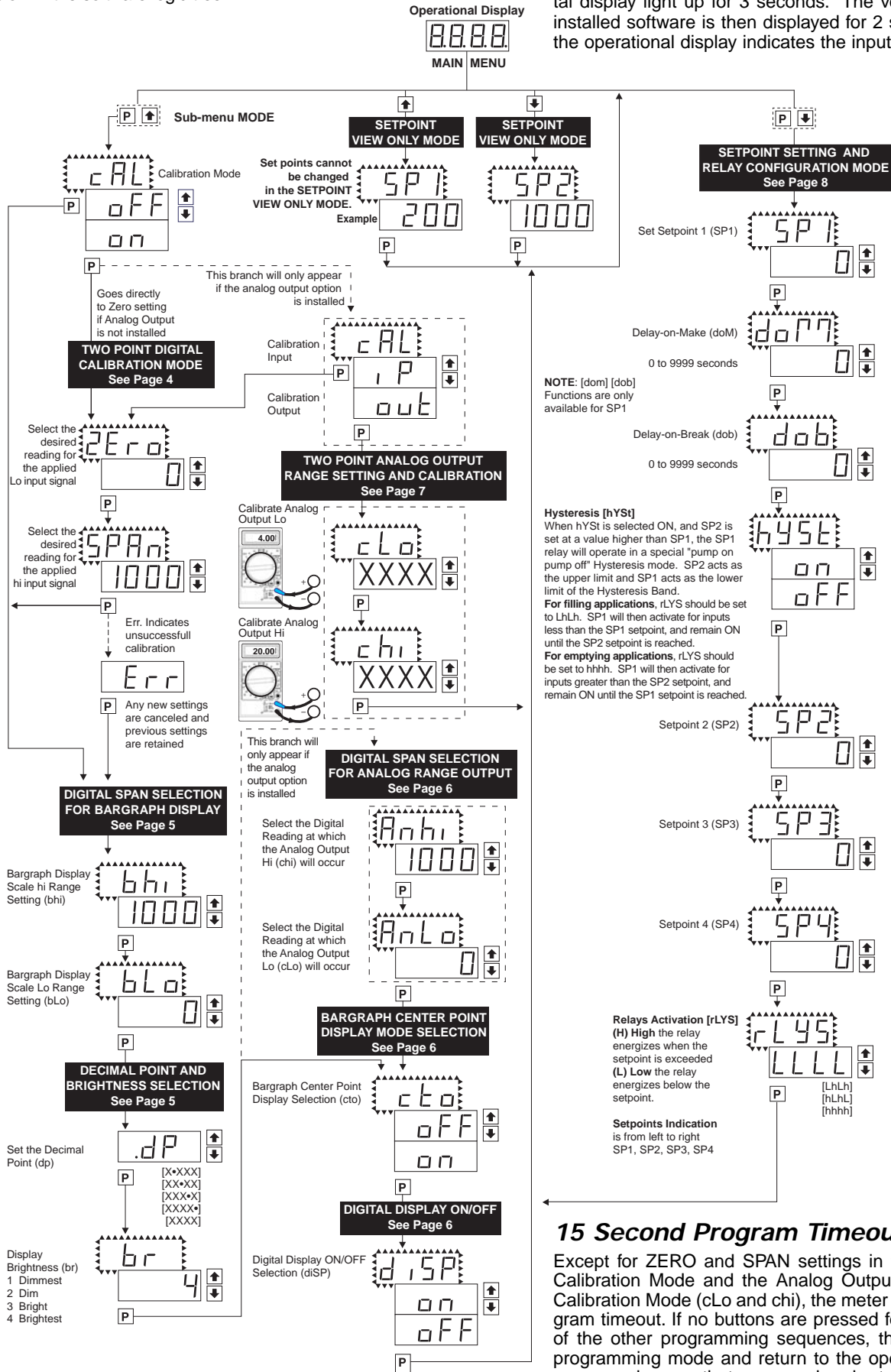

15 Second Program Timeout

Except for ZERO and SPAN settings in the Two Point Digital Calibration Mode and the Analog Output Range Setting and Calibration Mode (cLo and chi), the meter has a 15 second program timeout. If no buttons are pressed for 15 seconds in any of the other programming sequences, the meter will exit the programming mode and return to the operational display. Any program changes that were made prior to pressing the [P] button in the preceding step will not be saved.

Two Point Digital Calibration Mode

This mode enables the meter to be calibrated by applying a zero or low input signal, entering the desired reading for that signal, then applying a high input signal, and then entering the desired reading for that signal. The meter then automatically calculates and programs in the requisite scale factor, within the following parameters.

1. Positive and negative signals may be applied, but the difference between the low and the high input signals must be at least 1000 counts or Err will be indicated.
2. Positive and Negative values for the desired reading can be entered, but the scale factor created can not exceed the Digital Display Span capability of the meter which is 12,000 counts between -1999 to 9999.
3. The internal Signal Span is limited to 3 V DC between -1 V DC to +2 V DC. Any outputs from an Input Signal Conditioning module that exceed these limits will cause the meter to indicate overrange regardless of the Digital Display Span scaled.

Note: Many input signal conditioners have provisions for analog calibration and scaling. If the meter is digitally set to read zero with a zero input (shorted input), and to read 1000 with a 1.000 V input, any pre-calibrated analog signal conditioner, with an output that does not exceed -1 V to +2 V, will read correctly without any further calibration when it is inserted in the meter.

STEP A Enter the Calibration Mode

- 1) Press the **P** and **↑** buttons at the same time. Display toggles between [CAL] and [oFF].
- 2) Press the **↑** or **↓** button. Display changes from [oFF] to [on].
- 3) Press the **P** button. Display toggles between [CAL] and [out].

Note: If at this point, the display skips directly to STEP C and toggles between [SPAN] and the previous [SPan] setting, the software is detecting that the optional analog output hardware is NOT installed.

STEP B Select Two Point Digital Calibration of Input Signal

- 1) Press the **↑** or **↓** button to select CAL [iP] for input signal calibration.
- 2) Press the **P** button. Display toggles between [ZEro] and the previous zero setting.

STEP C Set the Meter's Low Input Signal Reading on the Digital Display

- 1) Apply a zero or low signal to the meter. (Positive or negative values are allowed).
- 2) Using the **↑** and **↓** buttons, adjust the meter display to the desired reading for the applied low input signal.
- 3) Press the **P** button. Display toggles between [SPAN] and the previous span setting.

STEP D Set the Meter's High Input Signal Reading on the Digital Display

- 1) Apply a high input signal to the meter.
- 2) Using the **↑** and **↓** buttons, adjust the digital display to the desired reading for the applied high input signal.
- 3) Press the **P** button.

The Digital Calibration Procedure is now complete.

If the digital calibration was successfully completed, the menu branches to the Digital Span Selection for Bargraph Display (see page 5), and the display flashes [bhi] and the previous setting.

ERROR Indicates Unsuccessful Calibration

If the calibration was unsuccessful, the display indicates [Err], the new calibration settings just entered will not take effect and the previously stored setting will remain. The three most likely causes of an error during calibration are:

1. The full scale and zero signals were too similar. The full scale signal must be at least 1000 counts greater than the zero or low input signal (positive and negative values are allowed).
2. The scaling requirement exceeded the digital display span capability of the meter (12,000 counts between -1999 to 9999).
3. No input signal present, or incorrect input signal connections.

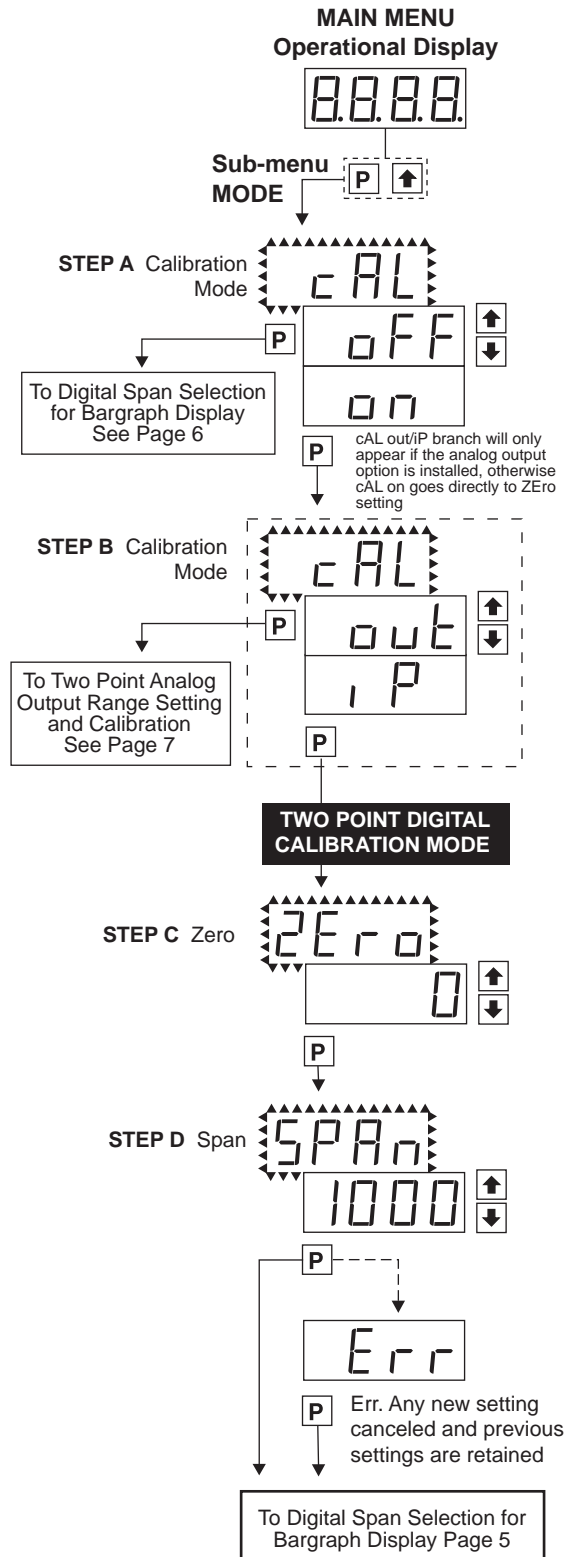

Digital Span Selection For Bargraph Display

The bargraph can be set to display full scale (0-51 bars) any portion of the digital reading from a minimum of 100 counts to a maximum of 12,000 counts. This provides higher resolution bargraph indication for those applications where the normal operating input signal range is less than the desired full scale display range of the digital display.

For Example:

If the full scale range of the meter has been set from -1999 to 9999 (0-12,000 counts), but the normal operating range of the input signal is between 4000 & 6000. The bargraph high parameter [bhi] can be set to 6000 and the bargraph low parameter [bLo] can be set to 4000.

This means that although the meter could digitally display a signal from -1999 to 9999 (0-12,000 counts), the bargraph display only begins to function at a reading of 4000, and reaches full scale indication at a reading of 6000. Although the digital display will continue reading up to 9999 before indicating overrange, the bargraph display will indicate its overrange by flashing for readings above 6000.

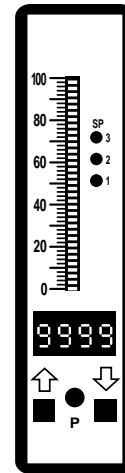

Bargraph Display Scale Range Setting Example

Input Signal of 3999 counts
Bargraph does not light up

Input Signal of 5000 counts
Bargraph lights up from 4000 to 5000 counts

STEP A Enter the Calibration Sub Menu Mode

- 1) Press the [P] and [↑] buttons at the same time. Display toggles between [CAL] and [oFF].
- 2) Press the [P] button. Display toggles between [bhi] and the previous setting.

STEP B Set the Digital Span of the Bargraph Display (See example above)

- 1) Using the [↑] and [↓] buttons, adjust the display to the desired high parameter reading, e.g. 6000 counts.
- 2) Press the [P] button. Display toggles between [bLo] and the previous setting.
- 3) Using the [↑] and [↓] buttons, adjust the display to the desired low parameter reading, e.g. 4000 counts.
- 4) Press the [P] button. Display changes from [4000] to [dP].

Decimal Point and Brightness Selection

STEP C Set the Decimal Point

- 1) Using the [↑] and [↓] buttons, adjust the display to the desired decimal point setting.
- 2) Press the [P] button. Display toggles between [br] and the previous brightness setting.

STEP D Set the Bargraph and Digital Display Brightness

- 1) Using the [↑] and [↓] buttons, adjust the display to the desired brightness setting (4 is the brightest setting).
- 2) Press the [P] button. Display toggles between [Anhi] and the previous [Anhi] setting.

Note: If at this point, the display skips directly to STEP G and toggles between [Cto] and [oFF], the software is detecting that the optional analog output hardware is NOT installed.

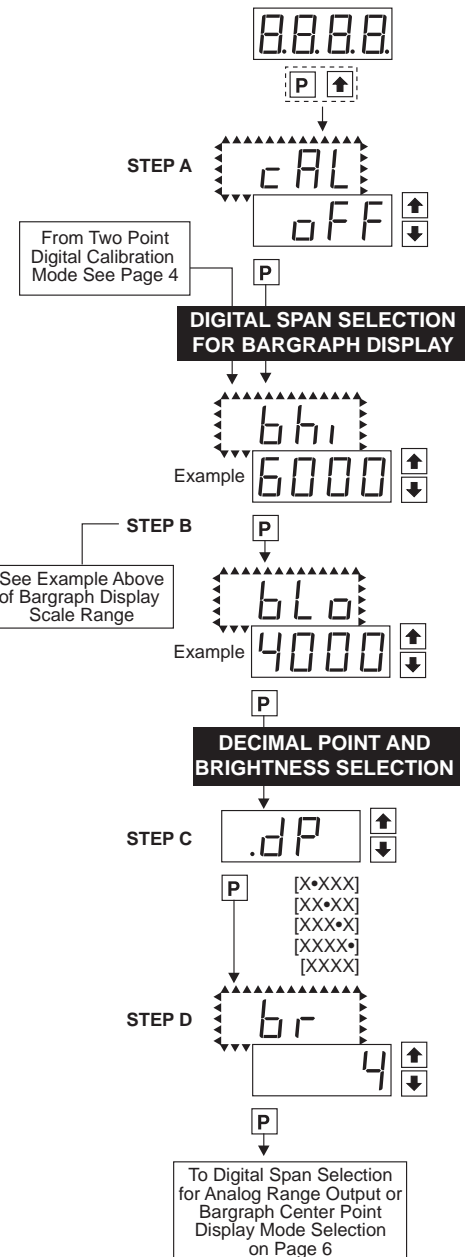

Digital Span Selection for Analog Range Output

STEP E Selecting the [Anhi] Digital Value for Analog High Output

- Using the \uparrow and \downarrow buttons, adjust the display to the desired digital value at which the [chi] Calibrated Analog High output will occur. For digital readings outside the digital span selected, the analog output will linearly rise above the value set for chi, up to the maximum analog output capability. However, the analog output will not go lower than the calibrated value set for cLo (see below).
- Press the \square button. Display toggles between [AnLo] and previous [AnLo] setting.

STEP F Selecting the [AnLo] Digital Value for Analog Low Output

- Using the \uparrow and \downarrow buttons, adjust the display to the desired digital value at which the [cLo] Calibrated Analog Low output will occur. For Digital readings outside the Digital Span selected, the analog output will not go lower than the calibrated value set for cLo.
- Press the \square button. The display toggles between [cto] and [oFF].

Note: Any two digital span points from -1999 to 9999 can be selected. The digital values for [Anhi] analog high and [AnLo] analog low can be reversed to provide a 20 to 4mA output. The digital span selected can be as small as two counts, when using the analog output to function as a Control or Alarm Driver. Small digital spans will cause the high resolution 16 bit D to A to increment digitally in stair case steps.

See Two Point Analog Output Range Setting and Calibration at the top of the next page.

Bargraph Center Point Display Mode Selection

Example of Using the Center Point Bargraph Display Mode with a Unipolar Input

If the meter's full scale range is set to 5000 counts, the midpoint would be 2500 counts. If a signal of 2500 counts is applied only one segment at the 2500 count mark will light up. If a signal of 4000 counts is applied the segments between the center segment (2500 counts) and the 4000 count mark light up.

If a signal of 1000 counts is applied, the segments between the center segment (2500 counts) and the 1000 count mark will light up.

Example of Using the Center Point Bargraph Display Mode with Bipolar Signal Inputs

The meter may also be calibrated to display symmetrical bipolar signals such as ± 1 V or ± 10 V. When the center point display mode is selected, it will then function as a center zero meter. When positive signals are applied, the bar will go up from the center point, and when negative signals are applied, the bar will go down from the center point.

STEP G Bargraph Center Point Mode Selection (See example above)

- To select bargraph center point mode, press the \uparrow or \downarrow button. Display changes from [oFF] to [on].
- Press the \square button. Display toggles between [diSP] and [on] or [oFF].

STEP H Digital Display ON/OFF Selection

- To set the display to [oFF], press the \uparrow or \downarrow button. Display toggles between [diSP] and [oFF].
- Press the \square button. The display exits the calibration mode and returns to the operational display. Only the bargraph display is on and the digital display is off.

If the digital display is selected to be off, pressing any button to make programming changes or to view setpoints activates the digital display. When the procedure is complete, the digital display will then automatically switch off.

The Display/Bargraph settings are now complete.

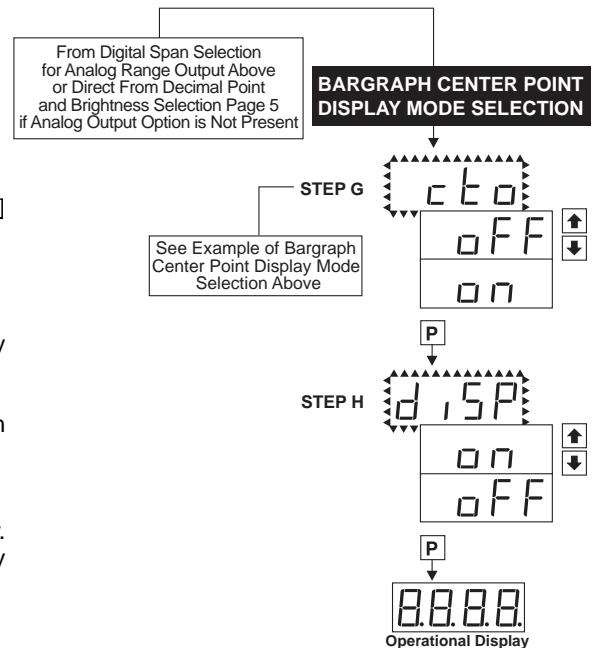
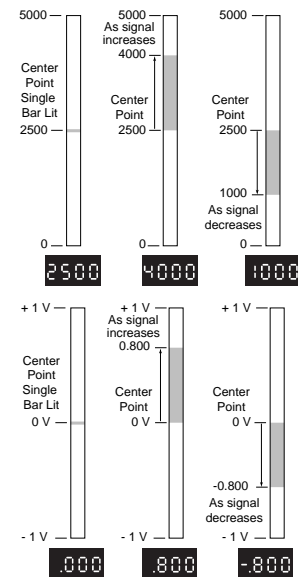
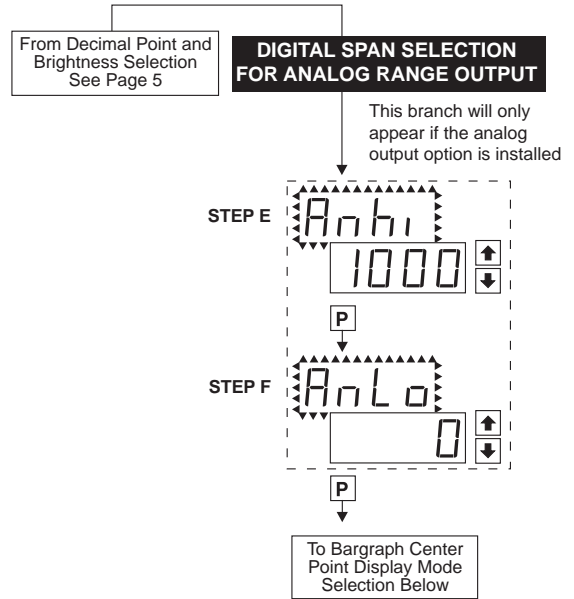

Two Point Analog Output Range Setting and Calibration

Determine if the Analog Output Selection Header is in the 4 to 20mA (0-20mA) position or the 0 to 10VDC position. If necessary, the module may have to be removed and the header position changed (see Component Layout below).

Note: Always disconnect power from the meter before removing the analog output module to adjust the mA or Volts output selection header and reinstalling it. When power is reconnected, the meter's software will automatically detect the presence or absence of the analog output module.

STEP A Enter the Calibration Mode

- 1) Press the **[P]** and **[↑]** buttons at the same time. Display toggles between [cAL] and [oFF].
- 2) Press the **[↓]** or **[↑]** button. Display changes from [oFF] to [on].
- 3) Press the **[P]** button. Display toggles between [cAL] and [out] input calibration.

Note: If at this point the display skips directly to toggle between Zero and the previous Zero setting, the software is detecting that the optional analog output hardware is NOT installed.

STEP B Enter the Two Point Analog [ouT] Output Range Setting and Calibration Mode

- 1) Press the **[P]** button. Display toggles between [cLo] and an internal scale factor.

STEP E Set or Calibrate [cLo] the Low Analog Value of the Analog Output Range

- 1) Connect a multimeter to analog output pins 17 and 18 (see Rear Panel Pinouts on page 10). Using the **[↑]** and **[↓]** buttons, adjust the analog output to the desired low value as measured on the multimeter. cLo may be adjusted to any value from -0.3 mA to 18 mA (mA output selected) or from -0.6 V to 8 V (volt output selected). However, the output of cLo must always be less than the value selected for chi. If a reversed analog output is desired, the values selected to establish the Digital Span can be reversed (see top of page 6). For digital readings outside the Digital Span selected, the analog output will not go any lower than the calibrated value set for cLo. However, the analog output will linearly rise above the value set for chi, up to the maximum analog output capability (see chi below).
- 2) Press the **[P]** button. Display toggles between [chi] and an internal scale factor.

STEP F Set or Calibrate [chi] the High Analog Value of the Analog Output Range

- 1) Using the **[↑]** and **[↓]** buttons, adjust the analog output to the desired high value as measured on the multimeter display. chi may be adjusted to any value from 18 mA to 24 mA (mA output) or from 8 V to 10.3 V (volt output). However, the value must be higher than the value selected for cLo. For digital readings outside the Digital Span selected, the analog output will linearly rise above the value set for chi, up to the maximum analog output capability.
- 2) Press the **[P]** button. The meter exits the calibration mode and returns to the operational display.

Note: The analog output range established by the values selected for cLo and chi will occur, automatically scaled, between the two digital values selected for AnHi and AnLo. However, the analog output can linearly rise above the chi value set for digital readings outside the digital span selected. See Digital Span Selection on page 6.

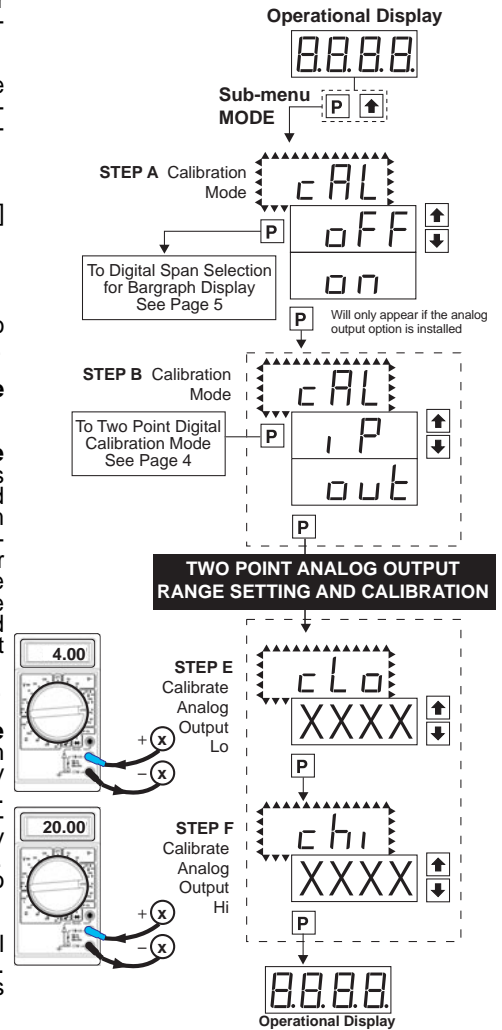

Case Dimensions

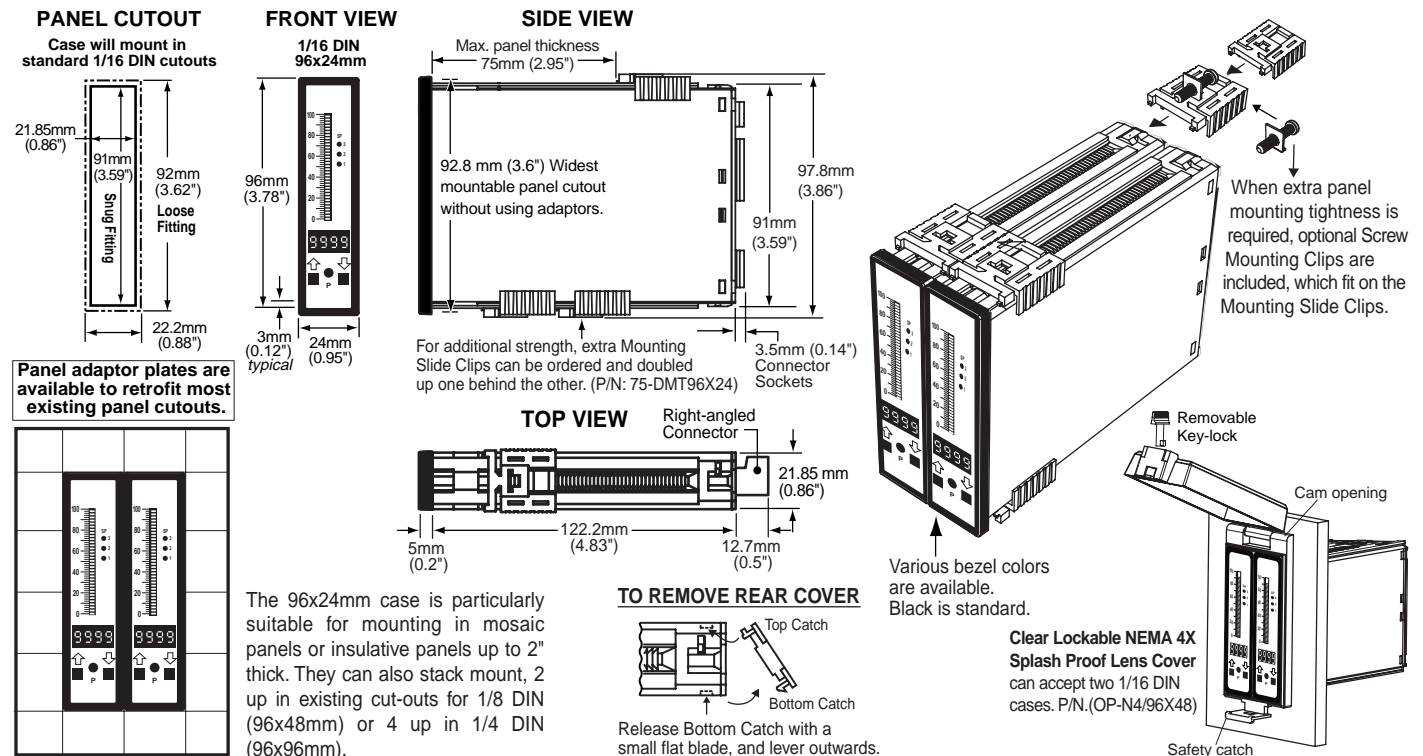

Setpoint Setting and Relay Configuration Mode

The following programming steps are required to enter the setpoint values and configure the relay functions in a meter with four relays using four setpoints. Generally if less than four relays are installed, the setpoints without relays are operational in software for tri-color control or display only purposes. To remove unwanted setpoint indications, set them to 9999 or -1999 depending on the relay activation mode selected.

STEP A Enter the Setpoint Mode

- 1) Press the and buttons at the same time. Display toggles between [SP1] and the previous SP1 setting.

STEP B Set Setpoint 1 (SP1)

- 1) Using the and buttons, adjust the display to the desired SP1 value.
- 2) Press the button. Display toggles between [doM] and the previous [doM] setting.

STEP C Set the SP1 Delay-on-Make (doM) Delay Time Setting

- 1) Using the and buttons, adjust the display to the desired [doM] value (0 to 9999 seconds). The reading must continuously remain in an alarm condition until this delay time has elapsed before the relay will make contact (energize).
- 2) Press the button. Display toggles between [dob] and the previous [dob] setting.

STEP D Set the SP1 Delay-on-Break (dob) Delay Time Setting

- 1) Using the and buttons, adjust the display to the desired [dob] value (0 to 9999 seconds). The reading must continuously remain in a non-alarm condition until this delay time has elapsed before the relay will break contact (de-energize).
- 2) Press the button. Display toggles between [hYSt] and the previous [hYSt] setting.

STEP E Select the Hysteresis (hYSt)

- 1) Using the and buttons, select the Hysteresis to be ON or OFF.
- 2) Press the button. Display toggles between [SP2] and the previous SP2 setting.

Note: When hYSt is selected ON, and SP2 is set at a value higher than SP1, the SP1 relay will operate in a special "pump on pump off" Hysteresis mode. SP2 acts as the upper limit and SP1 acts as the lower limit of the Hysteresis Band on the SP1 relay.

For filling applications:

rLYS should be set to LhLh (see step I). The SP1 relay and SP1 LED Annunciator will then activate for inputs less than the SP1 setpoint, and remain ON until the SP2 setpoint is reached.

For emptying applications:

rLYS should be set to hhhh (see step I). The SP1 relay and SP1 LED Annunciator will then activate for inputs greater than the SP2 setpoint, and remain ON until the SP1 setpoint is reached.

STEP F Set Setpoint 2 (SP2)

- 1) Using the and buttons, adjust the display to the desired SP2 value.
- 2) Press the button. Display toggles between [doM] and the previous [doM] setting.

STEP G Set Setpoint 3 (SP3) (No [doM] or [dob])

- 1) Using the and buttons, adjust the display to the desired SP3 value.
- 2) Press the button. Display toggles between [SP4] and the previous SP4 setting.

STEP H Set Setpoint 4 (SP4) (No [doM] or [dob])

- 1) Using the and buttons, adjust the display to the desired SP4 value.
- 2) Press the button. Display toggles between [rLYS] and the previous relay setting.

STEP I Set Relay Activation mode [rLYS]

(H) High the relay energizes when the setpoint is exceeded. (L) Low the relay energizes below the setpoint. The setpoint is indicated from left to right SP1, SP2, SP3, SP4.

- 1) Using the and buttons, adjust the reading on the display to the desired relay settings: [LLLL], [LhLh], [LLhh], [hhhh].
- 2) Press the button.

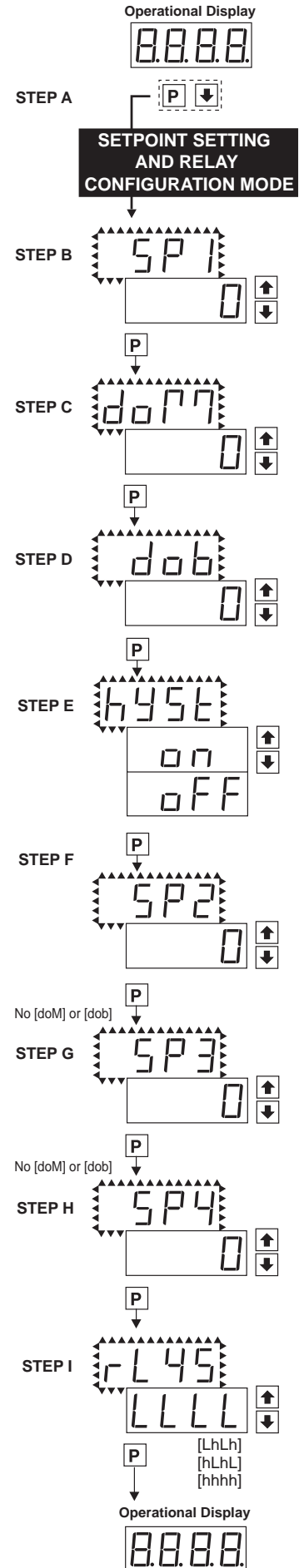

Functional Diagram

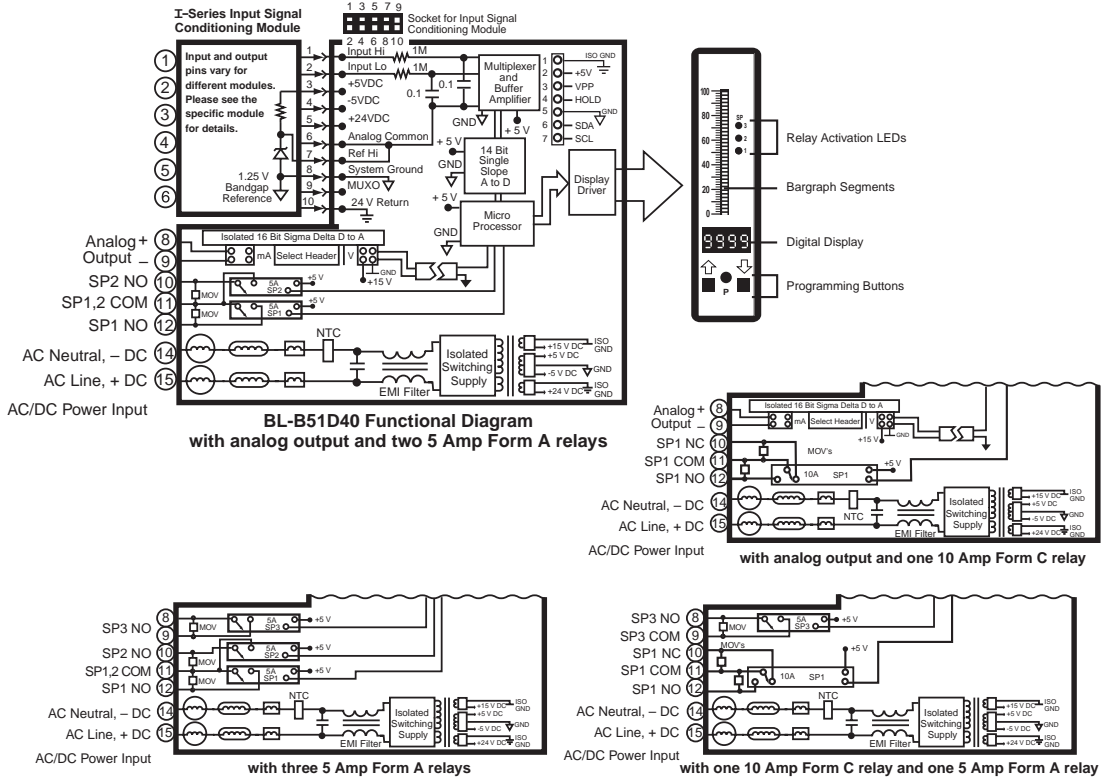

Connector Pinouts

Rear Panel Pinout Diagram

The BL-B51D40 uses plug-in type screw terminal connectors for all input and output connections.



WARNING: AC and DC input signals and power supply voltages can be hazardous. Do Not connect live wires to screw terminal plugs, and do not insert, remove or handle screw terminal plugs with live wires connected.

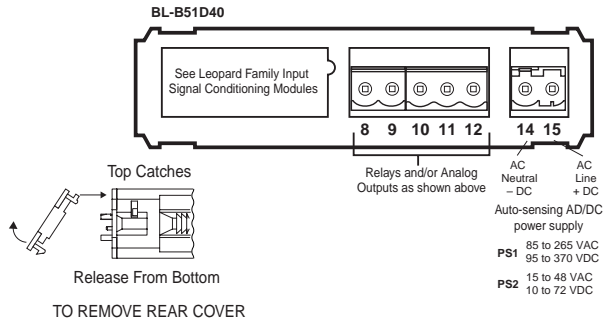

Pin Descriptions

Input Signal – Pins 1 to 6

Pins 1 to 6 are reserved for the input signal conditioner. See the data sheet for the selected input signal conditioner.

Pins 8 to 12 – Relay and Analog Output Pins

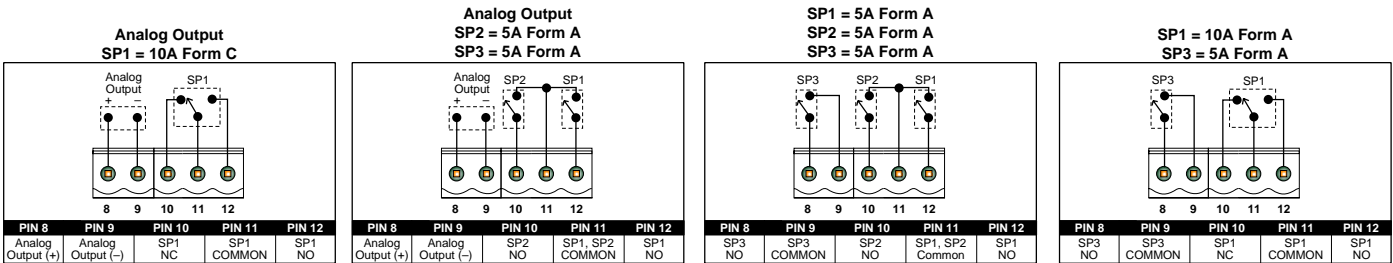

Pins 14 and 15 – AC/DC Power Input

Auto sensing AC/DC power supply. For voltages between 85-265 VAC or 95-370 VDC (PS1).

Pin 14 & Pin 15 - AC/DC Power Input: These pins are the power pins of the meter and they only accept a special polarized screw terminal plug that can not be inserted into any other input socket. The standard meter has a auto sensing AC/DC power supply that operates from 85-265 VAC/95-370 VDC (PS1 Std). An optional isolated low voltage power supply that operates from 15-48 VAC/10-72 VDC (PS2) is also available.

Component Layout

Typical Input Signal Conditioner

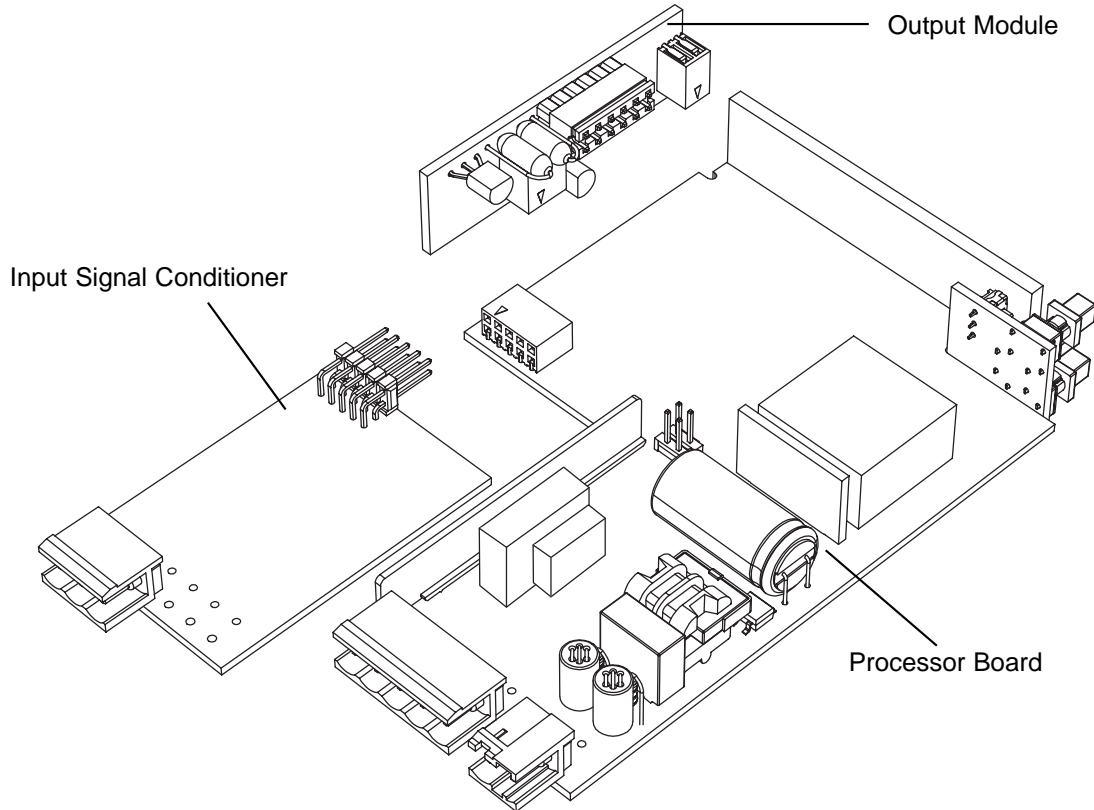
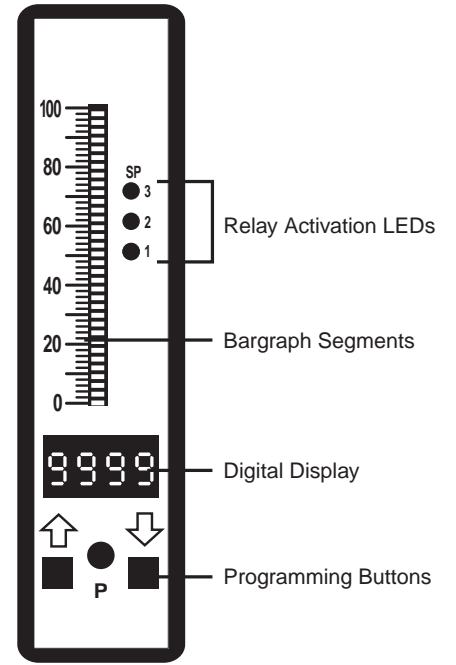
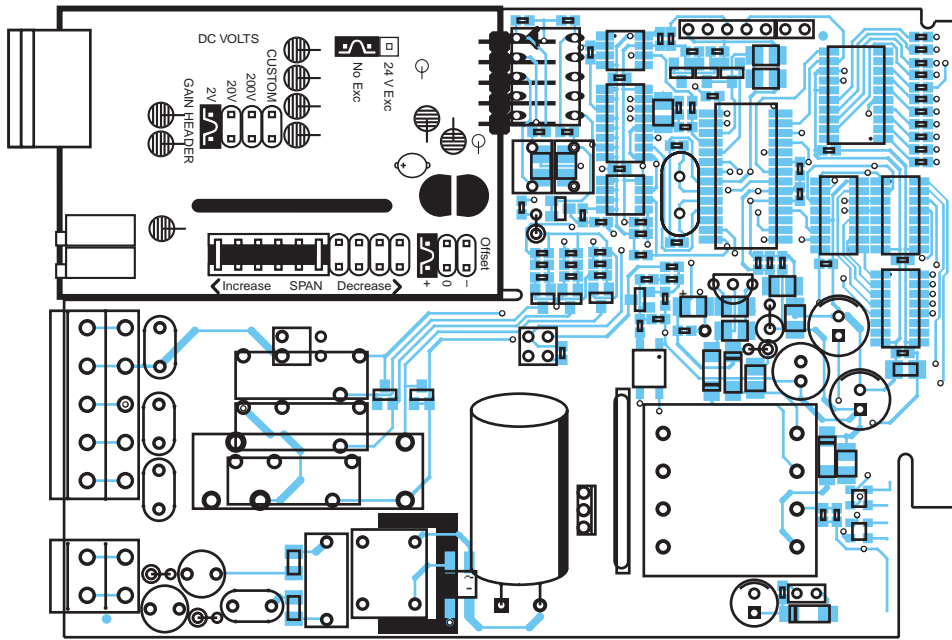

Connectors



WARNING

AC and DC input signals and power supply voltages can be hazardous. Do Not connect live wires to terminal blocks, and do not insert, remove or handle terminal blocks with live wires connected.

Standard plug-in screw terminal blocks provided:



Pin Socket

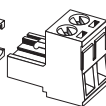

Input Power Screw Terminal Plug

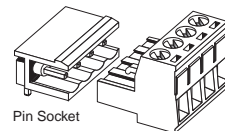

Right-angled Screw Terminal Plug

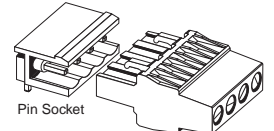

Straight-thru Screw Terminal Plug

I-Series Input Signal Conditioning Modules

Many additional input modules are available and others are constantly being developed. Check with your local distributor.

Precalibrated **I-Series** input modules, that have span or zero potentiometers, can be interchanged between any **I-Series** compatible meter, without recalibration, because all of the analog scaling and reference circuitry is self-contained within the module. Where appropriate, all the standard ranges shown are designed to be header selectable by the user, and Texmate's unique SPAN ADJUST Header facilitates scaling to almost any required engineering unit. See Input Module Component Glossary and Calibration on pages 14 and 15.

Unless otherwise specified Texmate will ship all modules precalibrated with factory preselected ranges and/or scalings as shown in **BOLD** type. Other precalibrated standard ranges or custom ranges may be ordered. Factory installed custom scaling and other custom options are also available (see Ordering Information, Special Options on last page).

Symbols Indicate Module Compatibility Within Meter Families		
TIGER Family	LEOPARD Family	LYNX Family
TIGER Family	LEOPARD Family	LYNX Family
TIGER Family	LEOPARD Family	LYNX Family
ALL MODELS	SOME MODELS	MODEL SPECIFIC



WARNING: AC and DC input signals and power supply voltages can be hazardous. Do Not insert, remove or handle modules with live wires connected to any terminal blocks.

IA01: AC Volts Scaled RMS, 200/600V AC

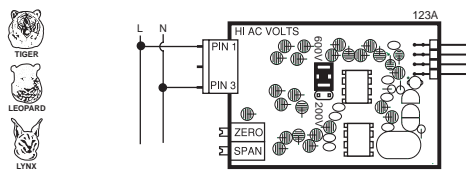

IA07: AC Volts True RMS, 200mV/2V/20V AC

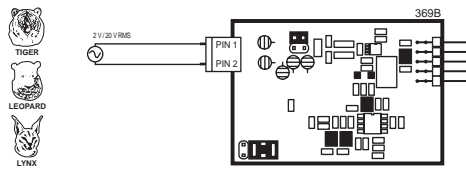

ID01: DC Volts, 2/20/200V/Custom w/24V DC Exc

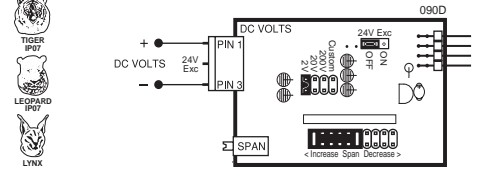

IA02: AC Volts Scaled RMS, 200mV/2V/20V AC

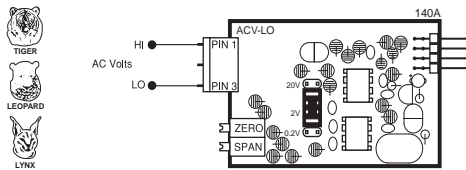

IA08: AC Milliamps True RMS, 2/20/200mA AC

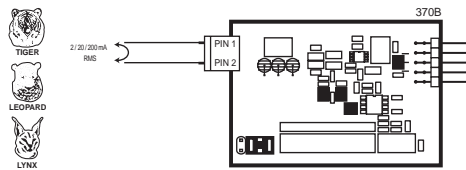

ID02: DC Millivolts, 20/50/100/200mV DC w/24V DC Exc

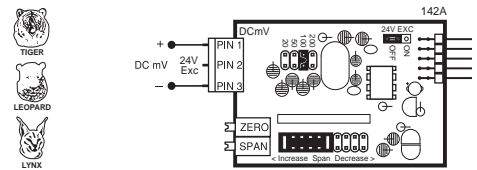

IA03: AC Milliamps Scaled RMS, 2/20/200mA AC

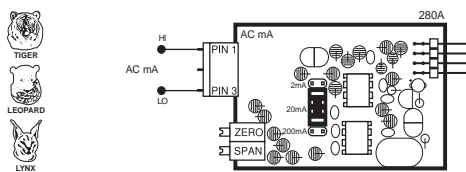

IA09: AC Amps True RMS, 1 Amp AC
IA11: AC Amps True RMS, 5 Amp AC

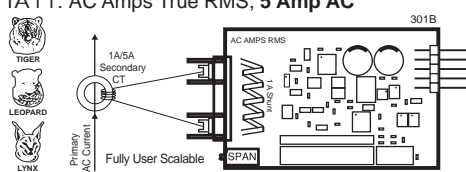

ID03: DC Milliamps, 2/20/200mA DC w/24V DC Exc

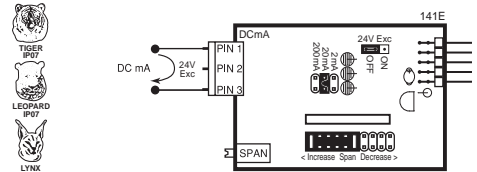

IA04: AC Amps Scaled RMS, 1 Amp AC
IA05: AC Amps Scaled RMS, 5 Amp AC

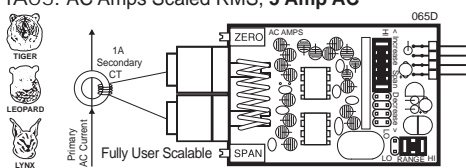

IA10 AC Millivolts, Scaled RMS, 100mV AC

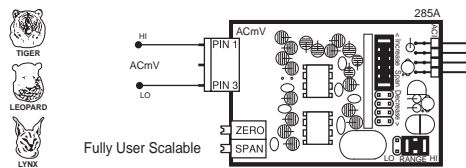

ID04: DC Amps, 5A DC
ID09: DC Amps, 1A DC

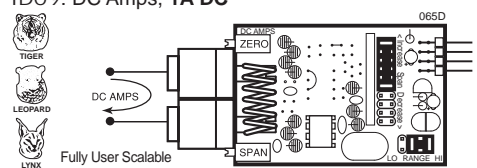

IA06: AC Volts True RMS, 300/600V AC

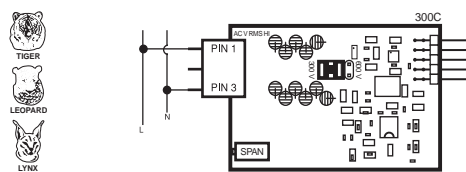

IA12: AC Millivolt RMS Sigma Delta

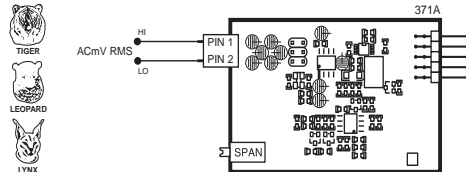

ID05: DC Volts 2/20/200/Custom V DC with Offset and 24V Exc.

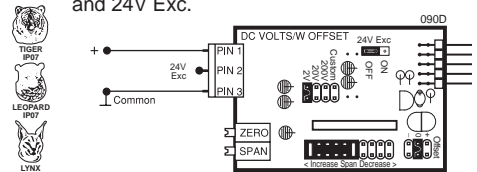

I-Series Input Signal Conditioning Modules Continued

ID07: DC Milliamps, 2/20/200mA DC with Offset and 24V Exc

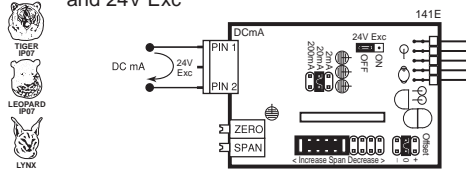

IF02: Line Frequency

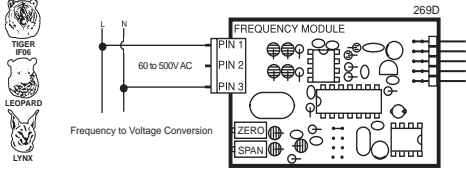

IGYZ: Universal Direct Pressure (Absolute or Differential/Gage)
See below for ordering code options

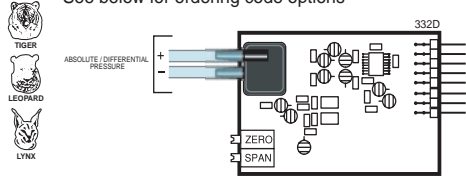

Ordering Code Options for Direct Pressure (IGYX, IGY Y & IGY Z)

Sensor Range	CH1 Order Code	CH2 Order Code
1 psi Absolute	A	A
1 psi Differential	B	B
3 psi Absolute	C	C
3 psi Differential	D	D
15 psi Absolute	E	E
15 psi Differential	F	F
30 psi Absolute	G	G
30 psi Differential	H	H
100 psi Absolute	J	J
100 psi Differential	K	K

For Single Channel IGYX with two digital inputs, the last digit of order code is always X.
For Universal Direct Pressure IGYZ, the last digit of order code is always Z.

IR02: 3 wire Potentiometer 1K min (0-F.S.)

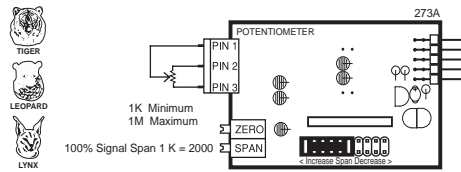

IR03: Linear Potentiometer 1KΩ min

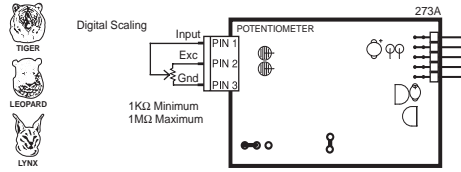

IR04: Resistance 2KΩ (Lynx only)
IR05: Resistance 2KΩ (Leopard only)

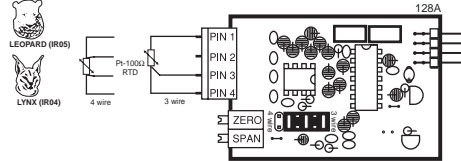

IS01: Strain Gage 5/10VDC Exc., 20/2mV/V, 4/6-wire
IS02: Pressure/Load Cell 5/10VDC Exc., 20/2mV/V, 4/6-wire

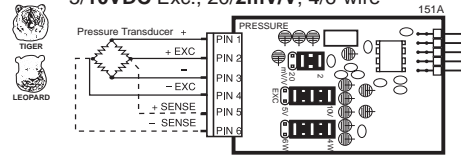

IP01: Process Loop, 4-20mA
IP02: Process Loop, 4-20mA with 24VDC EXC

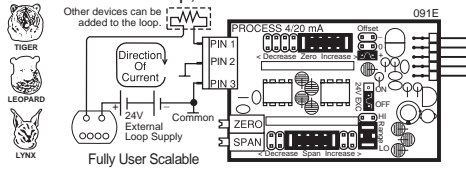

IS04: Pressure/Load Cell Ext Exc., 20/2mV/V, 4/6-wire

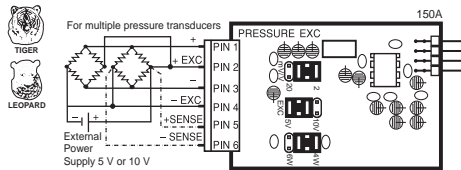

IP03: Process Input, 1-5V DC with Offset, 24V Exc

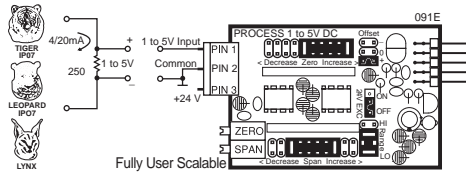

IS05: Pressure/Load Cell 20/2mV/V, 5/10V Exc 4-wire

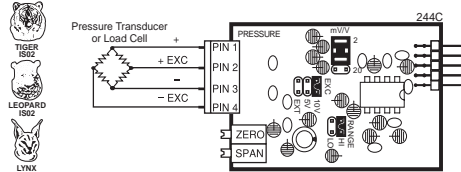

IP07: Universal Process Input
2V/5V/10V/20V/200V/2mA/20mA/Custom

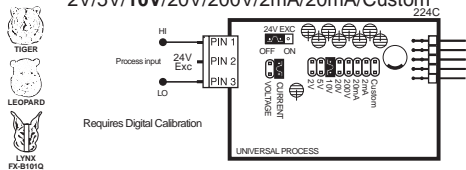

IS06: Pressure/Load Cell Ext Exc., 20/2mV/V, 4-wire

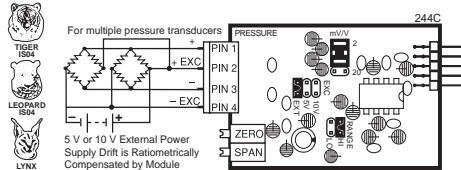

IPT1: Prototype Board for Custom Design

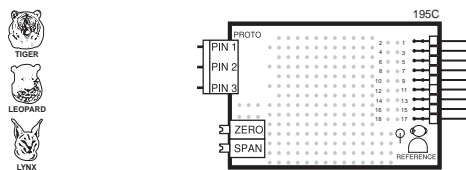

IS07: Pressure/Load Cell Ext Exc. High Impedance, 20/2mV/V, 4/6-wire

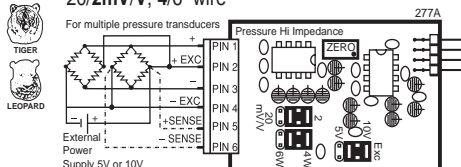

IT03: RTD, 100 Pt. 2/ 3/4-wire (-200 to 800°C)
IT04: RTD, 100 Pt. 2/ 3/4-wire (-200 to 1470°F)
IT05: RTD, 100Ω Pt. 2/3/4-wire (-199.9 to 199.9°F)
IT14: RTD, 100Ω Pt. 2/3/4-wire (-199.9 to 199.9°C)

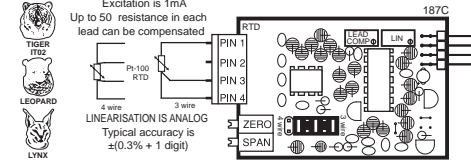

IT06: Thermocouple, J Type (0-1400 °F)
IT08: Thermocouple, J Type (0-760 °C)

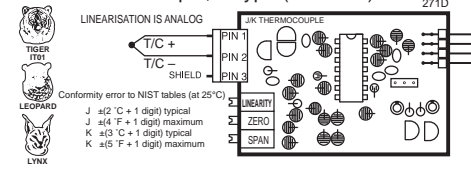

IT07: Thermocouple, K Type (0-1999 °F)
IT09: Thermocouple, K Type (0-1260 °C)

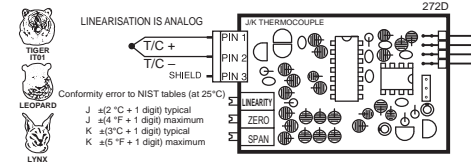

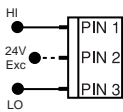

Input and Output Pins

On most modules Pin 1 is the Signal High input and Pin 3 is the Signal Low input. Typically Pin 2 is used for Excitation Voltage output.

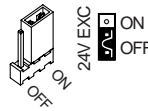

24V DC Output Header

On some modules this header enables a 24V DC 25mA (max) Excitation/Auxiliary output to be connected to Pin 2.

INPUT RANGE Header

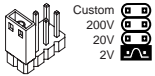

Range values are marked on the PCB. Typically two to four positions are provided, which are selected with either a single or multiple jumper clip. When provided, a custom range position is only functional when the option has been factory installed.

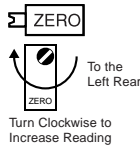

ZERO Potentiometer (Pot)

If provided, the ZERO pot is always to the left of the SPAN pot (as viewed from the rear of the meter). Typically it enables the input signal to be offset $\pm 5\%$ of full scale (-100 to +100 counts).

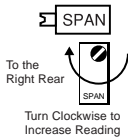

SPAN Potentiometer (Pot)

If provided, the 15 turn SPAN pot is always on the right side (as viewed from the rear of the meter). Typical adjustment is 20% of the input signal range.

SPAN ADJUST Header

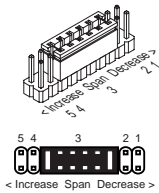

This unique five-position header expands the adjustment range of the SPAN pot into five equal 20% steps, across 100% of the input Signal Span. Any input Signal Span can then be precisely scaled down to provide any required Digital Display span from 1999 counts to 001 (one count).

SPAN Adjust Header position	1	2	3	4	5
SPAN Pot %	20%	20%	20%	20%	20%
Signal Span %	20%	40%	60%	80%	100%

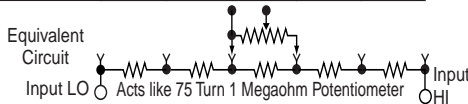

SPAN RANGE Header

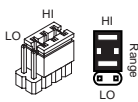

When this header is provided it works in conjunction with the SPAN ADJUST Header by splitting its adjustment range into a Hi and a Lo range. This has the effect of dividing the adjustment range of the SPAN pot into ten equal 10% steps across 100% of the input Signal Span.

SPAN Adjust Header position	Span Adjust Header					Span Range Header				
	1	2	3	4	5	1	2	3	4	5
SPAN Pot %	10%	10%	10%	10%	10%	10%	10%	10%	10%	10%
Signal Span %	10%	20%	30%	40%	50%	60%	70%	80%	90%	100%

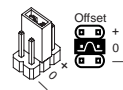
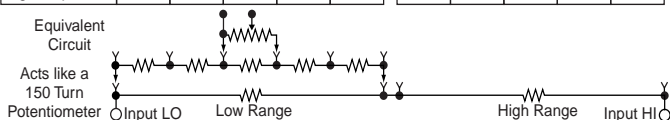

ZERO OFFSET RANGE Header

When provided, this three position header increases the ZERO pot's capability to offset the input signal, to $\pm 25\%$ of the digital display span. For example a Negative offset enables a 1 to 5V input to display 0 to full scale. The user can select negative offset, positive offset, or no offset (ZERO pot disabled for two step non-interactive span and offset calibration).

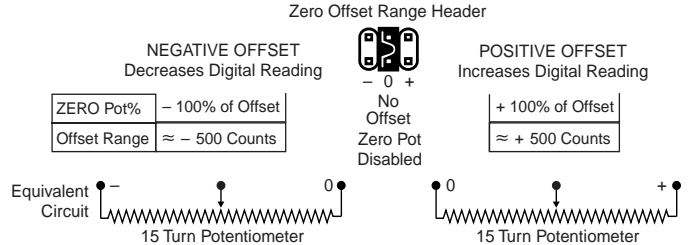

ZERO ADJUST Header

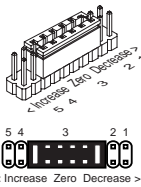

When this header is provided, it works in conjunction with the ZERO OFFSET RANGE Header, and expands the ZERO pot's offset capability into five equal negative steps or five equal positive steps. This enables virtually any degree of input signal offset required to display any desired engineering unit of measure.

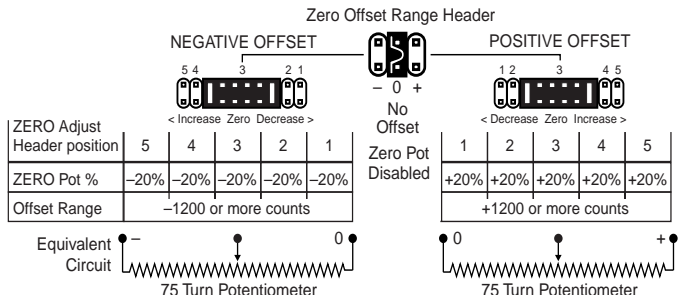

Input Module Calibration Procedures

Basic standard range calibration of direct reading modules that utilize either Auto Zero or a ZERO pot, an INPUT RANGE Header and or a SPAN pot.

- 1 If the module has an INPUT RANGE Header, reposition the jumper clip to select the desired input signal range.
2. Apply a zero input or short the input pins. The display will auto zero, or if the module has a ZERO pot, it should be adjusted until the display reads zero.
- 3 Apply a known input signal that is at least 20% of the full scale input range and adjust the SPAN pot until the display reads the exact input value.
- 4 Decimal Points. The selection or positioning of decimal points has no effect on the calibration of the modules

Wide range scaling, in engineering units not requiring offsets, with modules that utilize auto-zero or a ZERO pot, a SPAN RANGE Header and or a SPAN ADJUST Header.

The unique SPAN ADJUST and SPAN RANGE Headers provide the circuit equivalent of an ultra-precision one megohm 75 or 150 turn potentiometer that can infinitely scale down any Input Signal SPAN to provide any full scale Digital Display Span from 1999 (counts) to 001 (one count).

If the module has an INPUT RANGE Header, and the required full scale Digital Display Span (counts) is to be larger than the directly measured value of the input Signal Span, then the next lower range on the INPUT RANGE Header should be selected. The resulting over range Signal Span is then scaled down, by selecting the position of the SPAN RANGE Header and or the SPAN ADJUST Header, which will reduce the input Signal Span to a percentage, that the required Digital Display Span can be reached by calibration with the SPAN pot.

Example A: 0 to 10 V to read 0 to 1800 gallons.

Signal Span = 10V, Digital Display Span = 1800 counts

- 1 Select the 2 V INPUT RANGE Header position. This will provide a digital display of 1800 counts with an input of only 1.8 V which is $(1.8 \div 10) = 18\%$ of the examples 10 V Signal Span.
- 2 To scale down the Signal Span to 18% select the 20% Signal Span position on the SPAN ADJUST Header (position 1) or if the module has a SPAN RANGE Header, select (LO Range) and 20% Signal Span position on the SPAN ADJUST Header (position 2).
- 3 Apply a zero input or short the input pins. The display will auto zero, or if the module has a ZERO pot, it should be adjusted until the display reads zero.
- 4 Apply 10 V and adjust the SPAN pot until the display reads 1800.

Large offset scaling and calibration of process signal inputs with modules that utilize ZERO ADJUST Headers and or ZERO OFFSET RANGE Headers.

Texmate's unique ZERO OFFSET RANGE Header enables the use of a simple two step scaling and calibration procedure for

those process signals that require large offsets. This eliminates the back and forth interaction, between zero and span settings, that is often required to calibrate less finely engineered products.

The first step is to set the ZERO OFFSET RANGE Header to the center position (No Offset) and scale down the Input Signal Span to a percentage that will enable calibration with the SPAN pot to reach the required Digital Display Span.

The second step is to set the ZERO ADJUST and or ZERO OFFSET RANGE Header to provide a positive or negative offset of sufficient counts that calibration with the ZERO pot will offset the Digital Display Span to produce the required digital reading.

Example B: 1 to 5 V to read -100 to 1500 °C.

Signal Span = 4V, Digital Display Span = 1600 counts

- 1 If the module has an INPUT RANGE Header the 2 V position should be selected. This will provide a digital display of 1600 counts for an input of 1.6 V which is $(1.6 \div 4) = 40\%$ of the examples 4 V signal span. To scale down the Signal Span to 40% select the 40% Signal Span position on the SPAN ADJUST Header (position 2).
- 2 If the module is a Process Input 1-5 V DC type, select the (Hi Range) position on the SPAN RANGE Header and the 100% Signal Span position on the SPAN ADJUST Header (position 5, max increase). This will provide a digital display of 1600 counts for an input of 4V which is 100% of the examples 4V Signal Span.
- 3 Set the ZERO OFFSET RANGE Header to the center position (no offset). Apply 1 V and adjust the SPAN pot until the display reads 400 . A 4V input would then read 1600 counts.
- 4 Set the ZERO OFFSET RANGE Header to the negative offset position. If the module has a ZERO ADJUST Header select the position that will provide a negative offset of ≈ -500 counts. Apply 1 V and adjust the ZERO pot until the display reads -100. Apply 5 V and check that the display reads 1500.

Example C: 4 to 20 mA to read 00.0 to +100.0%

Signal Span = 16 mA, Digital Display Span = 1000 counts.

- 1 The full scale Signal Span of the Process Input 4-20 mA modules is 0 to 20 mA for a full scale Digital Display Span of 0 to 2000 counts. This will provide a digital display of 1000 counts with an input of only 10 mA which is $(10 \div 16) = 62.5\%$ of the examples 16 mA signal span.
- 2 To scale down the Signal Span to 62.5% select the (Hi Range) Position on the Span Range Header and the 70% Signal Span position on the SPAN ADJUST Header (position 2).
- 3 Set the ZERO OFFSET RANGE Header to the center position (no offset). Apply 4 mA and adjust the SPAN pot until the display reads 250 . A 16 mA input would then read 1000 counts.
- 4 Set the ZERO OFFSET RANGE Header to the positive offset position. If the module has a ZERO ADJUST Header select the position that will provide a negative offset of ≈ -250 counts. Apply 4 mA and adjust the ZERO pot until the display reads 000. Apply 20 mA and check that the display reads 1000.

Ordering Information

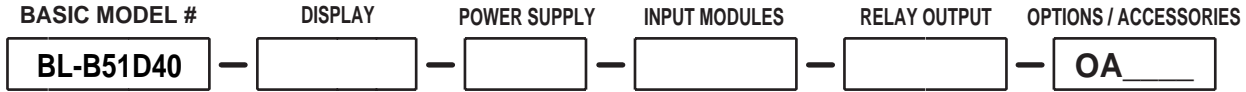

Add to the basic model number the order code suffix for each standard option required. The last suffix is to indicate how many different special options and or accessories that you may require to be included with this product.

Ordering Example: BL-B51D40-HRR-PS1-IA01-O1C-R1-OA2, the 2 OA's are, HD-CHANGE and a GN.CAS96X24L

► BASIC MODEL NUMBER

BL-B51D40 . . .96x24mm, Leopard, 51 Segment Bargraph, 4 Digit

Standard Options for this Model Number

Order Code Suffix *Description*

► DISPLAY

VRR . . .Red LED Bargraph w/4 Digit Red DPM, Vertical

► POWER SUPPLY

PS1 . . .85-265VAC/95-370VDC
PS2 . . .15-48VAC/10-72VDC

► INPUT MODULES (Partial List. See www.texmate.com)

Unless otherwise specified Texmate will ship all modules precalibrated with factory preselected ranges and/or scalings as shown in **BOLD** type.

- IA01 . . .AC-Volts Scaled RMS, 200/**600V** AC
- IA02 . . .AC-Volts Scaled RMS, 200mV/**2V/20V** AC
- IA03 . . .AC-mA Scaled RMS, **2/20/200**mA AC
- IA04 . . .AC-Amps Scaled RMS, **0-1 Amp AC (0-100.00)**
- IA05 . . .AC-Amps Scaled RMS, **0-5 Amp AC (0-100.00)**
- IA06 . . .AC-Volts True RMS, 200/**600V** AC
- IA07 . . .AC-Volts True RMS, 200mV/**2V/20V** AC
- IA08 . . .AC-mA True RMS, **2/20/200**mA AC
- IA09 . . .AC-Amps True RMS, **0-1 Amp AC (0-100.00)**
- IA10 . . .AC-Millivolt, Scaled RMS, **100mV** AC
- IA11 . . .AC-Amps True RMS, **0-5 Amp AC (0-100.00)**
- IA12 . . .AC-Millivolt, True RMS, **100mV** AC
- ID01 . . .DC-Volts, **2/20/200V**/Custom w/24V DC Exc
- ID02 . . .DC-Millivolt, **20/50/100/200**mV DC w/24V DC Exc
- ID03 . . .DC-Milliamp, **2/20/200**mA DC w/24V DC Exc
- ID04 . . .DC-Amps, **5A** DC
- ID05 . . .DC-Volts **2/20/200**/Custom V DC w/Offset and 24V Exc
- ID07 . . .DC-Milliamp, **2/20/200**mA DC w/Offset and 24V Exc
- ID09 . . .DC-Amps, **1A** DC
- IF02 . . .Line Frequency, 50-500VAC, 199.9Hz, or optional 400Hz
- IGYZ* . . .Universal Direct Pressure

*View the IG- Ordering Code on page 13 to determine the value for Y & Z (IGAZ to IGKZ)

- IP01 . . .Process Loop, **4-20mA(0-100.00)**
- IP02 . . .Process Loop, **4-20mA(0-100.00)** w/24VDC Exc
- IP03 . . .Process Input, **1-5V DC(0-100.00)** w/Offset, 24V Exc
- IP07 . . .Universal Process **2V/5V/10V/20V/200V/2mA/20mA**/Custom
- IPT1 . . .Prototype Board for Custom Design
- IR02 . . .3-Wire Potentiometer **1KΩ** min (0-F.S.)
- IR03 . . .Linear Potentiometer, 3-wire, **1KΩ** min

- IR05 . . .Resistance **2KΩ**
- IS01 . . .Strain Gage 5/10VDC Exc., **20/2mV/V, 4/6**-wire
- IS02 . . .Pressure 5/10VDC Exc., **20/2mV/V, 4/6**-wire
- IS04 . . .Pressure Ext Exc., **20/2mV/V, 4/6**-wire
- IS05 . . .Pressure/Load Cell **20/2mV/V, 5/10V** Exc 4-wire
- IS06 . . .Pressure/Load Cell Ext Exc., **20/2mV/V, 4**-wire
- IS07 . . .Pressure **20/2mV/V** with High Impedance and External Excitation
- IT03 . . .RTD, **100Ω** Pt. **2/3/4**-wire (**-200 to 800°C**)
- IT04 . . .RTD, **100Ω** Pt. **2/3/4**-wire (**-200 to 1470°F**)
- IT05 . . .RTD, **100Ω** Pt. **2/3/4**-wire (**-190.0 to 199.0°F**)
- IT06 . . .Thermocouple, J Type (**0-1400 °F**)
- IT07 . . .Thermocouple, K Type (**0-1999°F**)
- IT08 . . .Thermocouple, J Type (**0-760 °C**)
- IT09 . . .Thermocouple, K Type (**0-1260 °C**)

► RELAY OUTPUT

- R1Single 5A Form A Relay
- R2Dual 5A Form A Relays

Special Options and Accessories (OA's)

Part Number *Description*

► SPECIAL OPTIONS (Specify Inputs or Outputs & Req. Reading)

- CR-CHANGECalibrated Range Change to another Standard Range
- CS-L/BARCustom Scaling within any Std. or Custom Selectable Range
- CSR-L/BARCustom Selectable Range Installation or Modification
- CSS-L/BARCustom Special Scaling beyond the Standard Range
- COR-L/RELAYCustom Output - Relays Installed in Non-Standard Locations
- CCP-L/SETUPNRC to Set-up Custom Configuration - Functions, Codes
- CCP-L/INSTLFactory Installation - Custom Configuration

► ACCESSORIES (Specify Serial # for Custom Artwork Installation)

- 75-DBBZ96X24Black Bezel for 96x24mm Case
 - 75-DMTC96X24Side Slide Brackets (2 pc) - extra set, extra strength
 - 75-GBBZ144x2Black Bezel for 144x24mm Case
 - ART-FS-S/D/CNRC for artwork & set-up Faceplate/Desc/Co.Logo
 - ART-FS-S/DNRC for artwork & set-up Faceplate/Desc
 - ART-FS-001Install Custom Faceplate per meter - 1 color
 - 93-PLUG2P-DPExtra Screw Terminal Conn., 2 Pin Power Plug
 - 93-PLUG2P-DRExtra Screw Terminal Conn., 2 Pin Plug
 - 93-PLUG3P-DRExtra Screw Terminal Conn., 3 Pin Plug
 - 93-PLUG4P-DRExtra Screw Terminal Conn., 4 Pin Plug
 - DN.CAS96X24LComplete 96x24mm Case with bezel
 - GN.CAS144X24Complete 144x24mm Case with bezel
 - OP-MCLP96X24Screw Mounting Clips (2 pc) - to screw tighten slide brackets
- Many other options and accessories are available. See full price list for more details. Prices subject to change without notice.*

WARRANTY

Texmate warrants that its products are free from defects in material and workmanship under normal use and service for a period of one year from date of shipment. Texmate's obligations under this warranty are limited to replacement or repair, at its option, at its factory, of any of the products which shall, within the applicable period after shipment, be returned to Texmate's facility, transportation charges pre-paid, and which are, after examination, disclosed to the satisfaction of Texmate to be thus defective. The warranty shall not apply to any equipment which shall have been repaired or altered, except by Texmate, or which shall have been subjected to misuse, negligence, or accident. In no case shall Texmate's liability exceed the original purchase price. The aforementioned provisions do not extend the original warranty period of any product which has been either repaired or replaced by Texmate.

USER'S RESPONSIBILITY

We are pleased to offer suggestions on the use of our various products either by way of printed matter or through direct contact with our sales/application engineering staff. However, since we have no control over the use of our products once they are shipped, **NO WARRANTY WHETHER OF MERCHANTABILITY, FITNESS FOR PURPOSE, OR OTHERWISE** is made beyond the repair, replacement, or refund of purchase price at the sole discretion of Texmate. Users shall determine the suitability of the product for the intended application before using, and the users assume all risk and liability whatsoever in connection therewith, regardless of any of our suggestions or statements as to application or construction. In no event shall Texmate's liability, in law or otherwise, be in excess of the purchase price of the product.

Texmate cannot assume responsibility for any circuitry described. No circuit patent or software licenses are implied. Texmate reserves the right to change circuitry, operating software, specifications, and prices without notice at any time.



995 Park Center Drive • Vista, CA 92081-8397

Tel: 1-760-598-9899 • USA 1-800-839-6283 • That's 1-800-TEXMATE

Fax: 1-760-598-9828 • Email: sales@texmate.com • Web: www.texmate.com

Texmate has facilities in Japan, New Zealand, Taiwan, and Thailand. We also have authorized distributors throughout the USA and in 28 other countries.

For product details visit www.texmate.com

Local Distributor Address