



TIGER FAMILY

DI-50EAN6 & DI-50TAN6

Programmable Meter Controllers
Tiger 320 Series PMCs
5 Digit 0.31" LEDs
in a 1/8 DIN Case

A powerful, intelligent, 5-digit Programmable Meter Controller (PMC) with modular outputs, input signal conditioning and advanced software features for monitoring, measurement, control and communication applications.

General Features

- The Tiger 320 Operating System supports an easy to use PC based Configuration Utility Program, which can be downloaded FREE from the web, and programming from front panel buttons.
- The T Version supports custom macro programs that can be easily produced with the Tiger 320 Macro Development System (available FREE on the web). The Development System enables programs to be written in BASIC, which can utilize any combination of the hundreds of functions and thousands of registers embedded in the Tiger 320 Operating System.
- Red, green, or superbright red 7-segment, 0.31" high LEDs with full support for seven segment alphanumeric text.
- 6 light bar annunciators to illuminate application specific text.
- Brightness control of LED display from front panel buttons.
- Modular construction with more than 120 interchangeable input signal conditioners and more than 25 interchangeable I/O modules.
- Up to 4 input channels with cross channel math for multi-channel processing.
- For applications where sensor excitation is required, modules are provided with 5V, 10V or 24 V DC voltage outputs.
- On demand tare, calibration and compensation can be initiated by the front panel program button.
- Autozero maintenance for super stable zero reading is provided for use in weighing applications.
- Programmable input averaging and smart digital filtering for quick response to input signal changes.
- Display text editing. Customize display text for OEM applications.
- Scrolling display text messaging on T meters with macros.
- Auto-sensing high voltage or optional low voltage AC / DC power supply.
- Serial output options include RS-232, RS-485, ModBus, Ethernet, DeviceNet or direct meter-to-meter communications.
- Single or dual 16-bit Isolated Analog Outputs. Programmable 0~4 to 20mA or 0 to 10V for retransmission, 4-20mA loops to drive valve actuators, remote controllers & displays, multi-loop feedback and PID output. Scalable from 1 count to full scale.
- Dual independent totalizers to integrate input signals.
- 6 super smart, independently programmable setpoints with 8 selectable functions, including latching, deviation, hysteresis, register resetting, tracking and dual PID. Plus 7 programmable timer modes on all 6 setpoints.
- Setpoint tracking, setpoint latching and manual relay reset.
- Setpoints activated from any input, any register in the meter or from any digital input.
- Plug-in I/O modules include electromechanical or solid state relays, logic outputs or open collector outputs. 6 inputs & 16 outputs of opto-isolated I/O can be connected to an external DIN Rail terminal block module.
- Internal program safety lockout switch to prevent tampering.
- Peak & valley (max & min) with front panel recall and reset.
- Real time clock with 15 year Lithium battery backup.
- Data logging within the meter (up to 4000 samples with date/time stamp).
- Optional NEMA-4 front cover.

Input Module Compatibility

TIGER FAMILY: More than 120 different Plug-in I-Series Input Signal Conditioners are approved for the Tiger Family of meters.

See *I-Series Input Signal Conditioning Modules Guide* (Z87) for an up-to-date list.





Table of Contents

General Features	1	Controls & Indicators	14-15	Functional Diagram	45
Specifications	2	Front Panel Configuration & Setup . . .	16	Connector Pinouts	45
Tiger 320 Series Literature Overview . .	3	Front Panel Programming Codes . .	17-18	Carrier Board Output Pins	46
Tiger 320 Series System Overview . .	4-5	Initial Setup Procedures	19-20	Relay and Logic I/O Modules	46
Planning to Use the Tiger 320	6-8	Display Brightness	20	Component Layout & Ext. Devices . .	47-48
Block Diagram of Tiger 320 Structure . .	9	Calibration Modes	21-24	I-Series Input Modules	49-55
Configuration Utility Program	10	Programming Procedures	25-37	Ordering Information	56-58
Custom Macro Program	11	Setpoint Programming Mode	38-43	Custom Faceplates	59
Index	12-13	Registers	44	Case Dimensions	60

Specifications

Display

- Digital Display:** 7-segment, 0.31" (8 mm) LEDs.
- Display Color:** Red (std). Green or Super-Bright Red (optional).
- Digital Display Range:** -19999 to 99999
- Update Rate:** 3 to 10 times per second
- Display Dimming:** 8 brightness levels. Front Panel selectable
- Scrolling Display Text Messaging:** Full alphanumeric, 7-segment text characters supported on T Version with macros.
- Polarity:** Assumed positive. Displays - negative
- Decimal Point:** Front panel, user selectable to five positions.
- Annunciators:** 6 red LEDs on front panel; one per setpoint. Also 6 red, green or yellow 19x4mm light bar annunciators to illuminate application specific text.
- Overrange Indication:** 
- Underrange Indication:** 
- Front Panel Controls:** PROGRAM, UP and DOWN.

Operating System (Tiger 320)

- Processor:** 32 bit with floating point maths (18.4 MHz).
- Flash Memory:** 64k, 4k for use by custom macros.
- RAM:** 1.25k and FeRAM 4k.
- EEPROM:** E Version 4k standard, T Version 32k standard. Memory upgrades available to 32k for LIN Tables and 1MB for Data Logging and custom macros.
- Registers:** 6144 registers comprised of 8, 16 or 32 bit signed, unsigned or floating point registers, implemented in a combination of RAM, FeRAM, Flash and EEPROM.
- Internal communication BUS:** 32 bit I²C BUS
- Real Time Clock (option):** Year:Month:Date:Hour:Minute:Second with 15 yr Lithium battery backup.

Configuration: Supports Front Panel Programming Codes and a PC-based Configuration Utility Program, which may be downloaded free from the web. T Version also supports custom macros.

Development System for Custom Macros

The Tiger 320 Macro Development System, which may be downloaded free from the web, can be used to create powerful macro software that allows Tiger 320 T Versions to be easily customized to suit any proprietary OEM application (see page 11).

Installed Application Software Includes

- Counter Functions:** Two built-in counters. UP counters, DOWN counters, UP/DOWN counters and high speed quadrature counters.
- Data Logging:** Logging with a date/time stamp, initiated at timed intervals, by activation of a setpoint, or manually. Data stored in internal 1MB EEPROM or in a removable 4 to 128M Flash Card Memory Module. Endless loop recording is supported.
- Input Compensation:** Provides compensation to the primary input channel (CH1) via channels 2, 3 or 4.
- Linearization:** 4 selectable 32 point or one 125 point flexible linearization tables are provided.
- Logic I/O:** 28 Macro programmable I/O ports supported.
- Manual Loader:** Front panel adjustable, 4 to 20mA or 0 to 10V isolated analog output.
- Math Functions:** Cross channel math functions to calculate the sum, difference, ratio or the product of two inputs.
- On Demand Functions:** Tare, compensation and calibration.
- Peak and Valley:** The meter can retain peak and valley (min/max) information and recall this on the front panel.
- Remote Setpoint Input:** Remote setpoint input via channel 2.
- Serial Output Protocols:** Selectable communication modes include ASCII, Modbus (RTU), Master Mode (for meter to meter communication) and an Epson compatible printer driver. DeviceNet and Ethernet optional output carrier boards are also supported.
- Setpoint Functions:** Six super smart setpoints with fully configurable hysteresis, on and off delays, one shot, pulse and repeat timers, latching, dual PID, setpoint tracking, resetting of registers, initiating of logging and printing.
- Signal Conditioning Functions:** Averaging, smart filter, rounding, square root, auto zero maintenance.
- Timer:** Timer functions supported in either time-up, time-down, or real-time clock modes.
- Totalizer:** Two totalizers for running total and batch totals of a process signal that can be accumulated over time.

Inputs

- Inputs Available:** More than 120 single, dual, triple and quad input signal conditioners available covering all types of analog, digital and mixed input signals (see page 49).
- Accuracy:** Tiger 320 PMCs enable the user to establish any degree of system accuracy required. Built-in compensation and linearization functions enable system accuracies of the order of $\pm 0.0001\%$ of reading for analog inputs. Stop -Start time resolution from $\pm 1\text{sec}$ to $\pm 0.7\text{nsec}$. Digital input and pulse counts ± 1 count.
- A/D Convertors:** A Dual Slope, bipolar 17 bit A/D is provided as standard on the main board. SMART modules can have 24 bit or 16 bit Delta-Sigma A/D convertors that utilize the internal I²C BUS.
- Temperature Coefficient:** Typically 30ppm/^oC. Compensation can be utilized to achieve system temperature coefficients of 1ppm.
- Warm Up Time:** Up to 10 minutes, depending on input module.
- Conversion Rate:** Typically 10 samples per second. However, SMART input modules are available that can convert at 60, 240, 480 or 960 samples per second.
- Control Output Rate:** Can be selected for 100msec or 10msec. Some SMART modules have SSR outputs that react within 1.2msec.
- Excitation Voltage:** Depends on input module selected. Typically, 5V, 10V or 24VDC is provided.

Outputs (See pages 46-47 for pinouts and details of modular construction)

- Three Optional Plug-in Carrier Boards:** Provide four different serial outputs or no serial output, support single or dual analog outputs, and accept any one of seven different plug-in I/O modules.
- 1. Standard Carrier Board:** Is available without a serial output, or with either an isolated RS-232 or an isolated RS-485 (RJ-6 socket).
 - 2. DeviceNet Carrier Board:** 5 pin 3.5mm screw terminal.
 - 3. Ethernet Carrier Board:** 10/100Base-T Ethernet (RJ-45 socket).
- Two Isolated Analog Output Options:** Mounted on any carrier board.
- 1. Single Analog Output:** Fully scalable from 4 to 20mA or 0 to 20mA (or reverse) and selectable for 0 to 10VDC (or reverse).
 - 2. Dual Analog Output:** Fully scalable from 0 to 10VDC (or reverse).

Analog Output Specifications: Accuracy: 0.02% FS. Resolution: 16-bit Delta-Sigma D/A provides 0.4 μ A on current scaling, 250 μ V on voltage scaling. Compliance: 500 Ω maximum for current output. 500 Ω minimum for voltage output. Update Rate: Typical 7 per second. Step Response: Typical 6msec to a display change. Scalable: From 1 count to full scale.

Seven I/O Modules: Plug into any carrier board from rear.

- 1. Four Relay Module:** Available in six combinations from one relay up to a total of two 10A Form C Relays* and two 5A Form A Relays**.
- 2. Four Relay Module:** Available with one to four 5A Form A Relays**.
- 3. Six Relay Module:** Available with five or six 5A Form A Relays**.
*Form C Relay Specifications: 10A 240VAC-1/2 HP, 8A 24VDC. Isolation 3000V. UL and CSA listed.
**Form A Relay Specifications: 5A 240VAC, 4A 24VDC. Isolation 3000V. UL and CSA listed.
- 4. Four Solid State Relay (SSR) Module:** Available with one to four independent (210mA DC only) or (140mA AC/DC) SSRs (400V max).
- 5. Six Output 5VDC / TTL or Open Collector:** Available with 0 to 5V or 0 to V+ (40VDC max).
- 6. Opto Isolated I/O Module:** Available in either 6 Outputs & 6 Inputs, or 16 Outputs and 6 Inputs. For connection to an external breakout box.
- 7. Flash Card Memory Module:** Available with 8 or 16 MB memory.

Power Supplies

- Auto sensing AC/DC (DC to 400Hz) hi volts std, low volts optional.
- PS1 (standard):** 85-265VAC / 95-370VDC @ 4W max 5W.
- PS2 (optional):** 14-48VAC / 10-72 VDC @ 4W max 5W.

Environmental (See Rear page for IP-65 & NEMA-4 options)

- Operating Temperature:** 0 to 50 $^{\circ}$ C (32 $^{\circ}$ F to 122 $^{\circ}$ F).
- Storage Temperature:** -20 $^{\circ}$ C to 70 $^{\circ}$ C (-4 $^{\circ}$ F to 158 $^{\circ}$ F).
- Relative Humidity:** 95% (non-condensing) at 40 $^{\circ}$ C (104 $^{\circ}$ F).

Mechanical (See Rear page for more details)

- Case Dimensions:** 1/8 DIN, 96x48mm (3.78" x 1.89")
- Case Material:** 94V-0 UL rated self-extinguishing polycarbonate.
- Weight:** 11.5 oz (0.79 lbs), 14 oz (0.96 lbs) when packed.

Approvals

CE: As per EN-61000-3/4/6 and EN-61010-1.

Tiger 320 Series Modular Literature Overview

►► The Tiger 320 Series, Modular Literature system, makes it easy to select detailed information about those specific functions required for your application and the Configuration of the Tiger 320 you intend using.

Copies of all Data Sheets / User Manuals and Supplements can be viewed page-by-page and/or downloaded from the document server on our website.

Programming Code Sheet

Generic to all Tiger 320 Series models, the Programming Code Sheet is a quick reference document that allows you to quickly view the meter's manual programming codes.



Shipped with each product ordered, copies are also available on request, or can be viewed and downloaded from the document server on our website.

Model Specific Data Sheet / User Manual



Specific to each 320 Series meter model, the data sheet / user manual describes the basic functions of the meter and how to configure the meter for these functions.

Shipped with each product ordered, copies are also available on request, or can be viewed and downloaded from the document server on our website.

The model specific data sheet / user manual contains:

- Technical Specifications
- Overview of Tiger 320 Series Software and Hardware
- Planning Guide
- Block Diagram of the Tiger 320 Software and Hardware
- Configuration Utility Program
- Custom Macro Programming
- Front and Rear Panel Controls
- Front Panel Button Manual Programming Codes Overview
- Programming Procedures
- Functional Diagram and Pinouts
- Hardware Layout and Available Input and Output Modules
- Meter Options, and Custom Faceplates
- Ordering Information

Supplements to Data Sheet / User Manual are Generic to all Tiger 320 Models

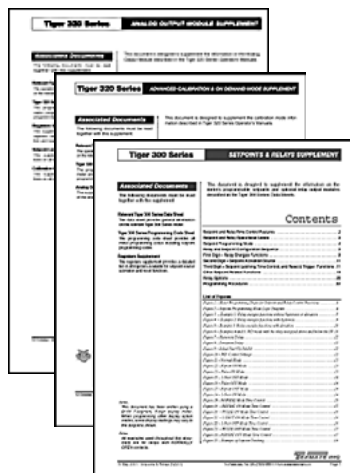

Generic to all Tiger 320 Series models, each supplement provides in-depth technical and procedural information on all individual meter modules, functions, or applications.

Listed are the supplements which are currently available:

Specific supplements are shipped with each product ordered to suit our customer's application. Copies are also available on request, or can be viewed and downloaded from the document server on our website.

- Advanced Calibration and On DEMAND Mode
- Analog Output Modules
- BASIC to Tiger 320 MACRO-Language Program Development System, Compiler and Tutorial
- Configuration Utility Program (Runs on PC)
- Linearizing Functions
- Meter Registers (for Macro Programming)
- Serial Communications Output Modules
- Setpoints & Relays
- Totalizing & Batching Functions

Other Tiger 320 Series Related Literature

Tiger 320 Functional Overview



A Quick Overview of the Awesome Power of the Tiger 320 Series

Tiger 320 Application Examples



Describes a Selection of Tiger 320 Applications

I-Series Input Signal Conditioning Modules



Includes all Available Input and Output Modules for the Tiger, Leopard and Lynx Families of Meters

Meters By the Case Size



Shows all Cases and Lists all Available Meters by Each Case Size and Type

An Overview of the Awesome Power of the Tiger 320 Series

The Tiger 320 Series of 32-bit Programmable Meter Controllers incorporates, in one instrument, all the different functions required by today's automation and process control applications.

1 Tiger 320 32-Bit Operating System

A virtual toolbox of selectable and programmable application software functions are embedded in the Tiger 320 Operating System. They integrate seamlessly with a truly vast array of modular input and output hardware options.

Embedded Application Software Includes:

- Multi-channel Inputs In Many Combinations
- Full Floating-point Maths
- Cross Channel Math (A+B, A-B, AxB, A/B)
- Square Root, Inverse and Log of Input
- 4 x 32 Point Or 1 x 125 Point Linearization Table
- Smart Auto Zero with Programmable Capture Band, Rate of Change and Aperture Window for Weighing Applications
- Set Tare Reset Tare for Batching
- Smart Quick Response Averaging
- Smart Timer and Time Integration Functions
- Time and Event-based Sequencing
- Polynomial Calculations
- Remote Reset of Any Function
- Dual Totalizers
- Dual PID

2 Data Logging and Memory Options

Up to 1MB of non-volatile on-board memory can be installed for (Black Box) endless loop recording. Up to 4000 data records can be continuously stored to provide before and after analysis of any process fault condition.

- Data log from 4 channels.
- Data log from 2 channels with date & time stamp.
- Log / print from setpoint or timer.

A Plug-in I/O Module is available with removable Flash Card Memory for high-capacity or long-term data logging.

Flash Cards are available from 4 to 128 Meg.

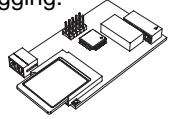

3 Real-time Clock



Optional Real-time clock with date and time stamp. 15 year lithium battery.

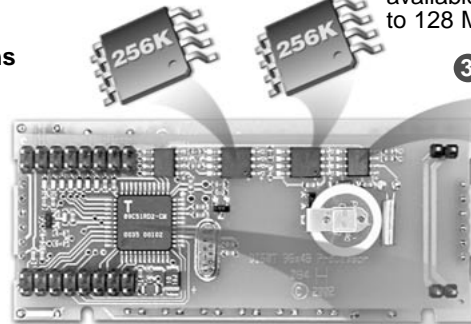

4 Powerful Custom Macro Programming Capability

Texmate's BASIC to Tiger 320 Macro-language Compiler can quickly Convert your special metering, control and automation ideas into reality.

This powerful easy to use development system enables programs to be written in BASIC utilizing any combination of the hundreds of functions and thousands of registers embedded in the Tiger 320 Operating System. When your BASIC program is compiled into the Tiger 320 Macro-language it is error checked and optimized. There are also numerous off-the-shelf application specific programs available. Many only need the blanks to be filled in to use them and this does not require any knowledge of BASIC.



Scrolling annunciator messages can be programmed to appear with any setpoint activation, selected events or logic inputs.

5 Programmable Front Panel Controls

Programmable Front Panel Controls

The front panel buttons can be used to control or program any standard functions.

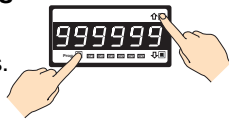

They can also be programmed to only access and display specifically designated functions, such as Tare, Auto-Cal or Print on Demand.

6 Configuration & Programming from a PC

PC Programming

Program the meter from a PC with Texmate's easy to use Tiger 320 Configuration Utility Program.

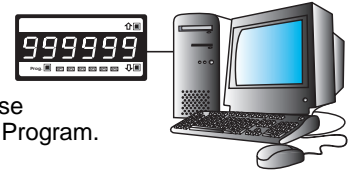

7 A Wide Selection of Display Formats & 8 Case Sizes to Suit any Application

Single or multiple LED or LCD displays
Numeric, Alpha Numeric and Bargraph

144x72mm 9/32 DIN

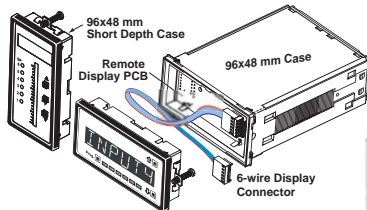

96x48mm 1/8 DIN



48x96mm 1/8 DIN



36x144mm 9/64 DIN



648x144mm 4" LED Remote Display 5 or 6 digit Driven by RS485 from any Tiger 320



8 22 Opto-Isolated I/Os on Plug-in Module & 6 Onboard Programmable I/O Logic Ports

- 6 Inputs & 16 Outputs or 6 Inputs & 6 Outputs
- Fully Programmable



Connects to DIN Rail terminal block module with 3M IDC cable

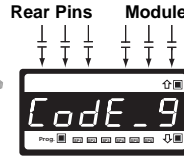

Three logic level inputs are provided on the module input header and three rear input pins are provided that can be programmed to STOP/START/RESET almost any function including: set tare, reset tare, relays, totalizers, print output, data logging, peak, valley, or any register from an external contact closure.

9 6 Super Smart Setpoints - 8 Selectable Functions - 7 Programmable Timer Modes

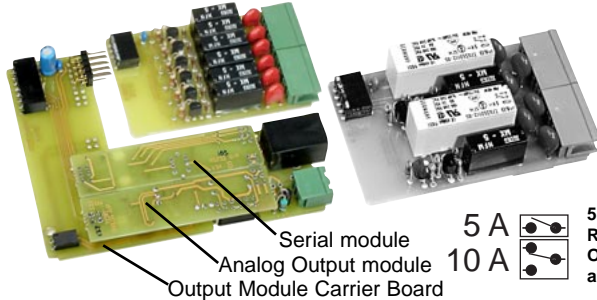

Serial module
Analog Output module
Output Module Carrier Board

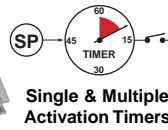

Single & Multiple Activation Timers

5 A
10 A
5 Amp and 10 Amp Relays or optional SSR Outputs can be energized above or below setpoints.

7 Multi Function Interval Timers on all 6 setpoints

- NormalAdjustable Delay On Make / Adjustable Delay On Break
- 1-Shot ONAdjustable Delay On Make / Adjustable Min OFF-Time
- 1-Shot OFFAdjustable Delay On Break / Adjustable Min OFF-Time
- Pulse ONAdjustable Delay On Make / Adjustable Max ON-Time
- Pulse OFFAdjustable Delay On Break / Adjustable Max OFF-Time
- Repeat ONAdjustable ON-Time / Adjustable OFF-Time
- Repeat OFFAdjustable OFF-Time / Adjustable ON-Time

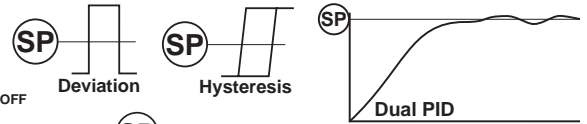

Dual PID

10 Scrolling Annunciator

Scrolling Annunciator up to 99 Characters long is available on all 6 setpoints for Alphanumeric Displays with Fill-in-the-blanks Macro.

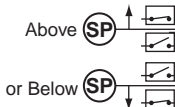

Activation

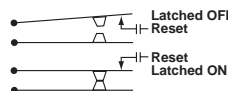

Relay Latching



#99 CHARACTER SCROLLING DISPLAY ON ALL SETPOINTS



12 16-bit Isolated Analog Outputs

Single

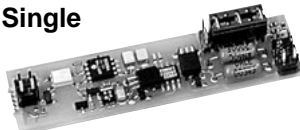

0 ~ 4-20mA or 0-10V

Dual

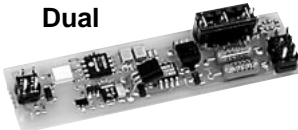

0-10V & 0-10V

Programmable 0~4 to 20 mA or 0 to 10 V for retransmission, 4-20 mA loops, drive valve actuators, remote controllers & displays, multi-loop feedback and PID output.

11 Serial Communications & Printer Output

RS-232

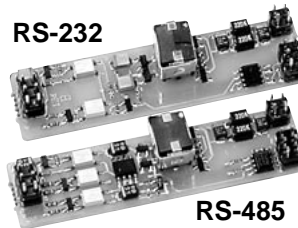

RS-485

Selectable Communication Modes include:

- ASCII
- Modbus
- Ethernet (TCP/IP)
- Devicenet (with optional carrier board installed)

Interface directly with PCs (using Window's terminal program), PLCs, or any Epson compatible serial printer.

Serial Printer Output

Smart printer driver makes simple serial printers look intelligent.

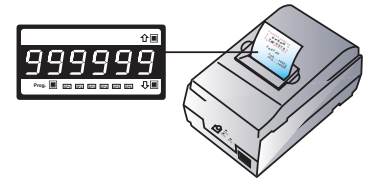

Meter to Meter Communication.

Direct meter to meter communication enables two meters to share data and resources.



13 Auto-sensing AC/DC Power Supply

- High Efficiency CE tested Auto Sensing AC/DC power supplies.
 - Standard 85-265 Volt AC / 95-370 Volt DC.
 - Low Voltage 9-32 Volt AC / 10-60 Volt DC.

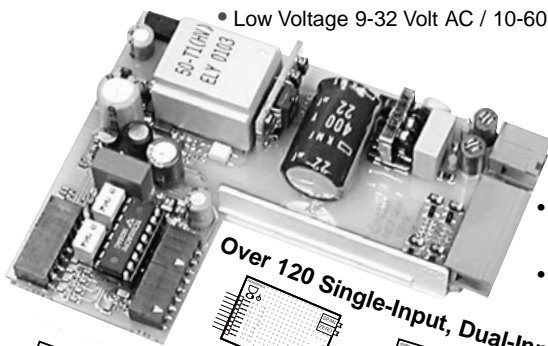

14 Over 120 Different Input Signal Conditioning Modules

- Choose from over 120 different single, dual, triple and quad input signal conditioners.
- Mixed function and smart modules with their own A/Ds, co-processors, SSRs and I²C Bus outputs are available to suit almost any application.

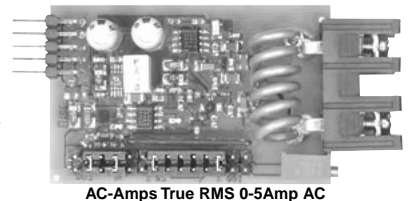

AC-Amps True RMS 0-5Amp AC

Over 120 Single-Input, Dual-Input, Triple Input and Quad-Input signal conditioners work with the Tiger 320 series

- Dual UP/DOWN Counter
- 16 Bit, 960 conversions per sec w/ultra High Speed SSRs
- pH with Automatic Temperature Compensation
- Dual Resistance Input, 0.2/2/20KΩ
- Dual Pressure Input, 4 wire 2mV/V, 20mV/V
- Quad RTD Platinum 100Ω RTD 4 wire connection
- Single Phase AC Power Watts, Amps, Volts, Hz, kWhr, Var, AmpHr, Power Factor
- Triple Input T/C, T/C and 4 to 20mA
- 24 Bit, Smart DC 1,000,000 Count Resolution
- Triple Input two 4 to 20mA's and Thermocouple, J/K/R/S/T/B or N
- Quad 4 to 20 mA
- 24 Bit Smart Strain Gage, 1,000,000 count res.

A combination of modular hardware and software resources enable Tiger 320 Series Programmable Meter Controllers (PMCs) to be easily configured as a cost effective solution for the most simple or the most complex of applications.

A review of your Project's objectives, its physical layout, the proposed sensors and control outputs will enable you to select the optimum configuration of the Tiger 320 PMC's unique hardware and software capabilities.

Input Signals & Sensors

4-20 mA or Sensor Direct

Unless sensors are located at a far distance, the greatest accuracy and best performance is usually obtained by connecting sensors directly to the Tiger 320, which will then function as the primary measurement device.

There are more than 120 Tiger compatible input signal conditioning modules, with the appropriate excitation outputs, to suit almost any type of sensor or combinations of up to 4 sensors.

In most cases, sensors with a 4-20 mA output are more costly, and when a separate 4-20 mA transmitter is used, signal conversion, drift, and calibration inaccuracies are introduced.

Some Tiger input modules combine direct sensor inputs with 4-20 mA inputs, enabling both local and far distant sensor inputs to be combined.

Sensor Linearization or Compensation

The performance of many sensors can be greatly enhanced or expanded with linearization and or compensation. Sensors may be compensated for temperature, frequency, altitude, humidity and mechanical position, to name just a few parameters.

Tiger PMCs with 32 kilobits or more of memory provide up to four 32-point user defined linearization tables or one combined 125-point table.

Many compensation methods can be implemented with the standard cross channel math capabilities of the Tiger's 32-bit operating system. Complex three-dimensional compensation can also be implemented using the powerful macro programming capability.

The serial number and calibration date of a sensor can be loaded into the meter. The serial number, linearization tables, and compensation factors of a newly calibrated sensor can then be saved for future reloading, either serially through a PC or directly through the web via an Ethernet port.

Although there are numerous input modules with combinations of various input signals, some inputs such as watts or pH are provided on input modules dedicated to a single function. Combining these inputs with each other signals two or more Tiger meters can serially communicate, and be configured to share their data and processing resources.

Display Options

Tiger PMCs have a large range of display options, including digital and alphanumeric LCDs, LEDs and Touch Panel HMIs.

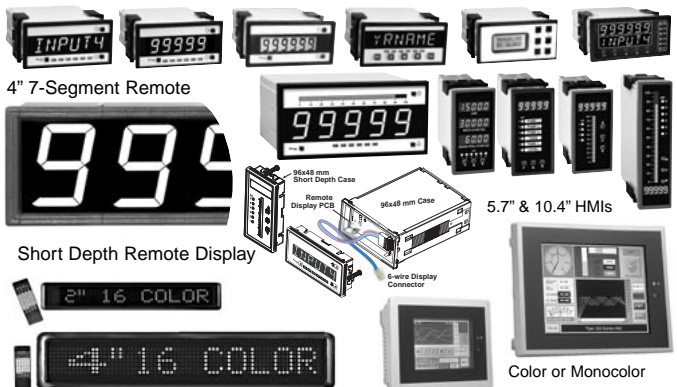

LED or LCD Displays

LED displays are a lower cost and popular display option. They operate over the largest temperature range, have better viewing angles and viewing distances, and have the longest operational life. However, red LEDs are difficult to read in direct sunlight without a shade hood and consume more power. Green LEDs and backlit LCD displays can be more easily read in direct sunlight.

The Tiger range can be ordered with red or green LEDs. LCD displays are also available, with or without backlighting.

Numeric or Alphanumeric Displays

Generally, numeric displays are a lower cost option than alphanumeric displays. The Tiger range supports a full 7-segment numeric and 14-segment alphanumeric alphabet of English letters and Arabic numerals. Where complex text messaging or alarm annunciation is required, we recommend using the 14-segment alphanumeric option.

Single or Multiple Display

The Tiger meter has four input channels and can be configured to display many different inputs or results. These can be viewed constantly on the operational display, or on demand in one of the view modes by pressing a button. Some applications require multiple values to be displayed simultaneously. With single, dual, or triple displays, and single displays with 51 or 101-segment bargraph combinations, we have a large range of display options to choose from.

Tiger meters can communicate with each other to share their data and processing resources and be stack or twin mounted to provide a wider range of display options.

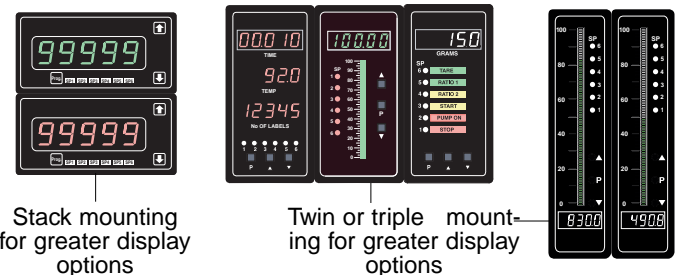

Push Button or Membrane Touch Pads

Tiger PMCs are shipped as standard with high usage hard plastic push buttons. An optional clear lens cover that opens on a cam hinge with a key lock can provide full NEMA 4 or IP65 dust and water proofing. Alternatively, an optional membrane touch pad faceplate can be ordered.



Control Outputs & I/O Logic

Electromechanical Relays or Solid State Control Outputs

Tiger PMCs have a wide selection of control outputs to choose from. The decision on which control output to choose depends on the current and the switching frequency.

Electromechanical relays are a popular choice for most control outputs. Tiger output modules are available with combinations of two 10 amp form C and two to six 5 amp form A relays that can be used to directly drive fractional HP motors or actuators.

The limitation of electromechanical relays is switching speed. If a relay needs to operate in less than 30 mS, or be cycled faster than .5 cpm, it is advisable to select an output module with solid state relays (SSR) or open collector outputs (OC), that can drive external high current SSRs.

DECISION **PID or On/Off Control**

Depending on the process to be controlled, either PID or on/off control should be selected. If the process variables are reasonably consistent, then the on/off control is generally more than adequate and easier to implement. Super smart setpoint control software supports many selectable functions, such as Hi or Lo activation, Latching, Hysteresis, Tracking, Register Resetting and 7 Multi-function internal Timers on all setpoints.

PLANNING TIP Control systems with large lag and lead times are not suitable for on/off control and tend to overshoot and undershoot. PID is needed to stabilize and control these systems. One of the many powerful setpoint functions provided by the Tiger 320 Operating System is single or dual PID.

DECISION **Retransmission 0-10V or 4-20mA**

Tiger PMCs can have an optional single (0-10 V or 0/4-20 mA) or dual (0-10 V) analog output module installed. The isolated 16-bit output is fully scalable and highly accurate. With a compliance of up to 500Ω at 20mA, the 4-20 mA output can be used over very long distances and still drive more than one output device, such as a PID controlled valve positioner.

PLANNING TIP The analog outputs can be reversed to output 20mA to 4/0 or 10 to 0VDC. They can be scaled across any portion of the digital range, up to full scale. The output can be programmed to swing 0 to 20mA or 0 to 10V in one digital count to drive external logic or SSRs as additional setpoints. Under Macro Program Control, the analog outputs can be programmed to produce pulses or even sinewaves.

DECISION **I/O Logic, Rear Panel or Breakout Box**

The Tiger Operating System has many built-in logic functions that can be used to develop sophisticated control systems. The Tiger PMC has three logic inputs/outputs available via the LOCK, HOLD, and CAPTURE pins, and three logic I/Os are available for input module use via pins D1, D2 and D3.

PLANNING TIP More complex I/O intensive applications require an opto-isolated I/O plug-in module, which supports six inputs and up to 16 outputs. This module can connect to an external Breakout Box that is DIN Rail mountable with screw terminal blocks. There are also compatible DIN Rail mounting electromechanical relays and SSR modules.

- 6 Inputs & 16 Outputs or 6 Inputs & 6 Outputs
- Fully Programmable

Connects to DIN Rail terminal block module with 3M IDC cable

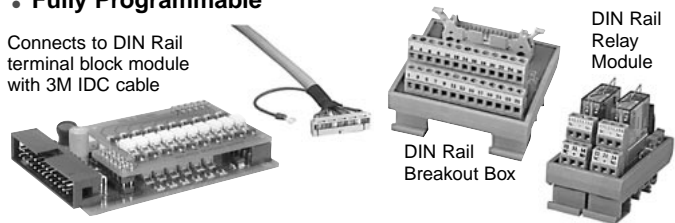

Serial Communication

The easiest way to configure or program a Tiger PMC is with the free user-friendly Configuration or Macro Development Software. Serial I/O is provided via an optional Plug-in output carrier board, which supports RS-232 or RS-485 output modules. If serial I/O is not required by the application, the serial carrier board can be removed for reuse. The Tiger 320 Operating System supports several serial protocols, including ASCII, Modbus RTU and Print Mode (which includes a printer driver and support for direct meter to meter communications). Also supported is DeviceNet, which requires a special dedicated carrier board, and Ethernet (TCP/IP), which requires an external converter box.

DECISION **RS-232 or RS-485**

Except for DeviceNet, all serial communication modes supported by the Tiger can function with either RS-232 or RS-485. The limitations of RS-232 are that only one meter at a time can be connected to the serial port of a computer, and the

distance from the computer to the meter is limited in practical terms to around 30 meters (100 feet).

PLANNING TIP Up to 32 meters can be connected on an RS-485 bus. The differential current drive of the RS-485 bus ensures signal integrity in the most harsh environments to distances up to 1230 meters (4000 feet). However, RS-485 generally requires a special RS-485 output card to be installed in the computer or an external RS-232 to RS-485 converter has to be used.

DECISION **Select the Communication Mode Best Suited to Your Application:**

Modbus (RTU)

Modbus is widely used in industry. It has a large base, and most SCADA and HMI software packages support it. See also Modbus Wrapped in Ethernet (Modbus/TCP) below.



PLANNING TIP There are 100s of HMI Touch Panel Screens that are compatible with the Tiger 320 Modbus interface.

ASCII

The meter configuration utility program and the development software use the ASCII protocol. The ASCII protocol allows you to write your own driver for your own application via the development software and should provide the quickest development time.

Print Mode

This is an ASCII based printer driver output that enables the serial port to be directly connected to any serial printer with Epson compatibility. Printer output can be configured to occur from a setpoint or on demand, and can be date or time stamped.

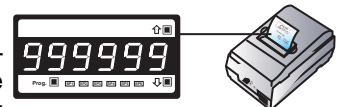

PLANNING TIP The print mode can also be used for computer data logging applications. The meter can be connected directly to a computer, set up in Microsoft Hyperterminal mode, with the meter programmed to output directly into a Microsoft Excel spreadsheet format. (Also see Data Logging).

Print Mode for Meter to Meter Communication

Two or more Tiger PMCs can be connected together allowing data to be transferred from the master meter (in print mode) to the slave meter (in ASCII mode). This enables the meters to share input data and control output functions.

Master Mode

This mode is for use with macro programming to expand the meter to meter communication capability to multiples of Tiger PMCs. This is useful for building an entire system of Tiger PMCs, sharing information and control output resources.

DECISION **Ethernet**

Ethernet has become a popular automation and control protocol. We supply an ethernet output option and several external ethernet converters that are compatible with the serial outputs of Tiger PMCs.



PLANNING TIP **Ethernet ASCII Wrap** - The ethernet output carrier board option wraps the ASCII output into the Ethernet protocol, and provides a T-base 10/100 Ethernet output socket. This allows the Configuration Utility Program or the Macro Development Software to run over a standard Ethernet network. This enables the Tiger meter to be configured or macro programmed from anywhere in the world via the web.

PLANNING TIP Up to 32 Tiger PMCs can be connected by RS-485 to a single Ethernet Converter, which will support up to 32 separate IP addresses.

PLANNING TIP **Ethernet Modbus Wrap** - This converter accepts the Tiger PMC's modbus protocol and outputs Modbus/TCP through an Ethernet T-base 10 port. This has become a standard for Ethernet on the factory floor. Many SCADA and HMI software packages connect directly to Modbus/TCP.

DeviceNet

DeviceNet was originally developed by Allen Bradley to connect sensors from the factory floor to PLCs. It is a deterministic real-time system, typically used to connect to networks using Allen Bradley PLCs. An optional carrier board is required for DeviceNet which replaces the standard serial output with a dedicated DeviceNet output connector.

Data Logging

The Tiger 320 Operating System has built-in, sophisticated data logging software. Data logging can be triggered from the PROGRAM button, digital inputs, time or alarm functions. Up to 1MB of optional extra on-board memory provides a powerful, multichannel data capture and acquisition system.

PLANNING TIP Tiger PMCs can be configured to log in an endless loop, overwriting the oldest data first and utilizing the maximum amount of memory available. Similar to the Black Box on an aircraft, the data can be downloaded for analysis after a problem event occurs.

PLANNING TIP Data logging can be combined with an Ethernet converter to provide an individual Web Page with data that can be accessed by a browser over the internet.

Real-time Clock

The Tiger meter has an optional real-time clock with a 15 year lithium battery backup, ensuring that time information is not lost in the event of a power failure. It can be configured in 12 or 24-hour modes for printing and data logging applications.

PLANNING TIP Other applications of the real-time clock include activating a setpoint or control action at fixed times of the hour, day, week, month or year.

Flash Card Memory Module

For long term data logging, a Flash Card Memory Module that plugs in to the carrier board output socket is available. Flash Cards are available from 4 to 128 meg. They can be removed and read by a standard card reader, or the data can be downloaded through the serial port or over the internet with an Ethernet converter. The module also has an SSR setpoint output to trigger an external event.

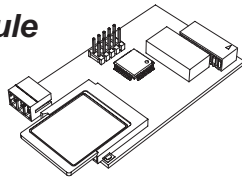

Configuration and Programming with a PC

With a serial output module installed, Tiger 320 PMCs are most easily configured using the Tiger 320 Configuration Utility, which can be downloaded free from the web and run on any Windows-based PC. The utility also enables the user to access some special capabilities of the Tiger 320 which cannot be programmed manually by the front panel buttons.

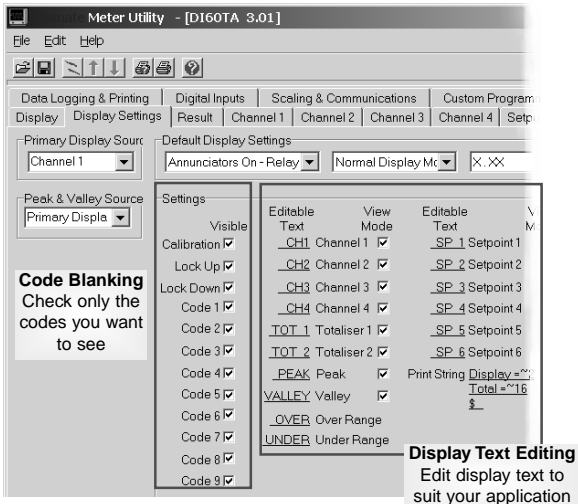

PLANNING TIP The Configuration Utility requires that an RS-232 interface board be installed in a Tiger 320 for programming. However, if the final application does not require a serial output, the RS-232 board can be easily removed, after programming is completed, and kept for future use.

PLANNING TIP When a Tiger 320 is to be used in a custom application, the utility enables all or any of the front panel programming functions to be disabled (code blanking). Customized descriptive text can also be entered to appear with any setpoint action or event.

PLANNING TIP Different configurations can be stored in a PC for fast downloading into a meter by the user. Custom configurations can also be issued a serial number and pre-loaded at the factory.

Development Software

Custom Macro Programming

This powerful, easy to use development system enables programs to be written in BASIC, utilizing any combination of the hundreds of functions and thousands of registers embedded in the Tiger 320 Operating System. When your Basic program is compiled into the Tiger 320 Macro-language it is error checked and optimized. There are also numerous off-the-shelf application specific programs available. Many only need the blanks to be filled in to use them and do not require any knowledge of BASIC programming.

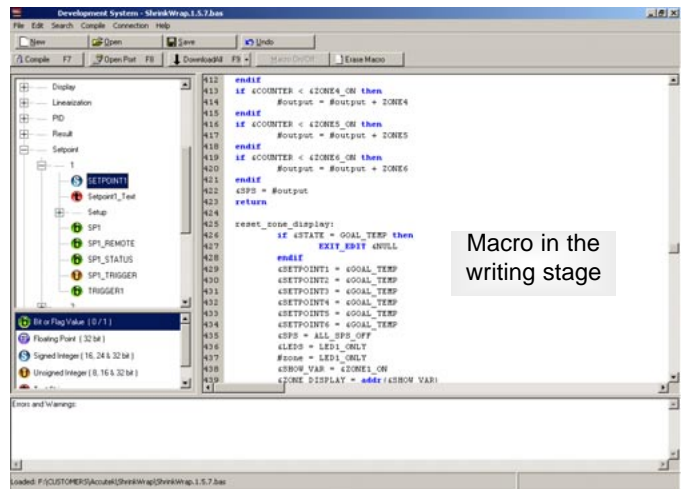

Macro in the writing stage

PLANNING TIP Macros are useful when implementing any specialized control system that cannot be achieved by the standard configuration capability of the Tiger 320 Operating System. Using the development software, functions can be altered or added in a standard meter to perform the required job. This may typically include logic sequencing functions and mathematical functions.

PLANNING TIP Developing a Macro is much easier and quicker than programming a PLC, because the basic code required to customize the Tiger meter is considerably less than the ladder logic programming required for PLCs. This is due to the hundreds of functions built into the Tiger meter that can be manipulated or invoked by a macro, to fulfill the requirements of almost any application.

PLANNING TIP Scrolling annunciator messages can be programmed to appear with any setpoint activation, selected events or logic inputs. Easy to read, plain text prompts can be programmed to replace the manual programming codes and provide a user-friendly interface for any custom application.



Block Diagram of the Tiger 320 Software and Hardware Structure

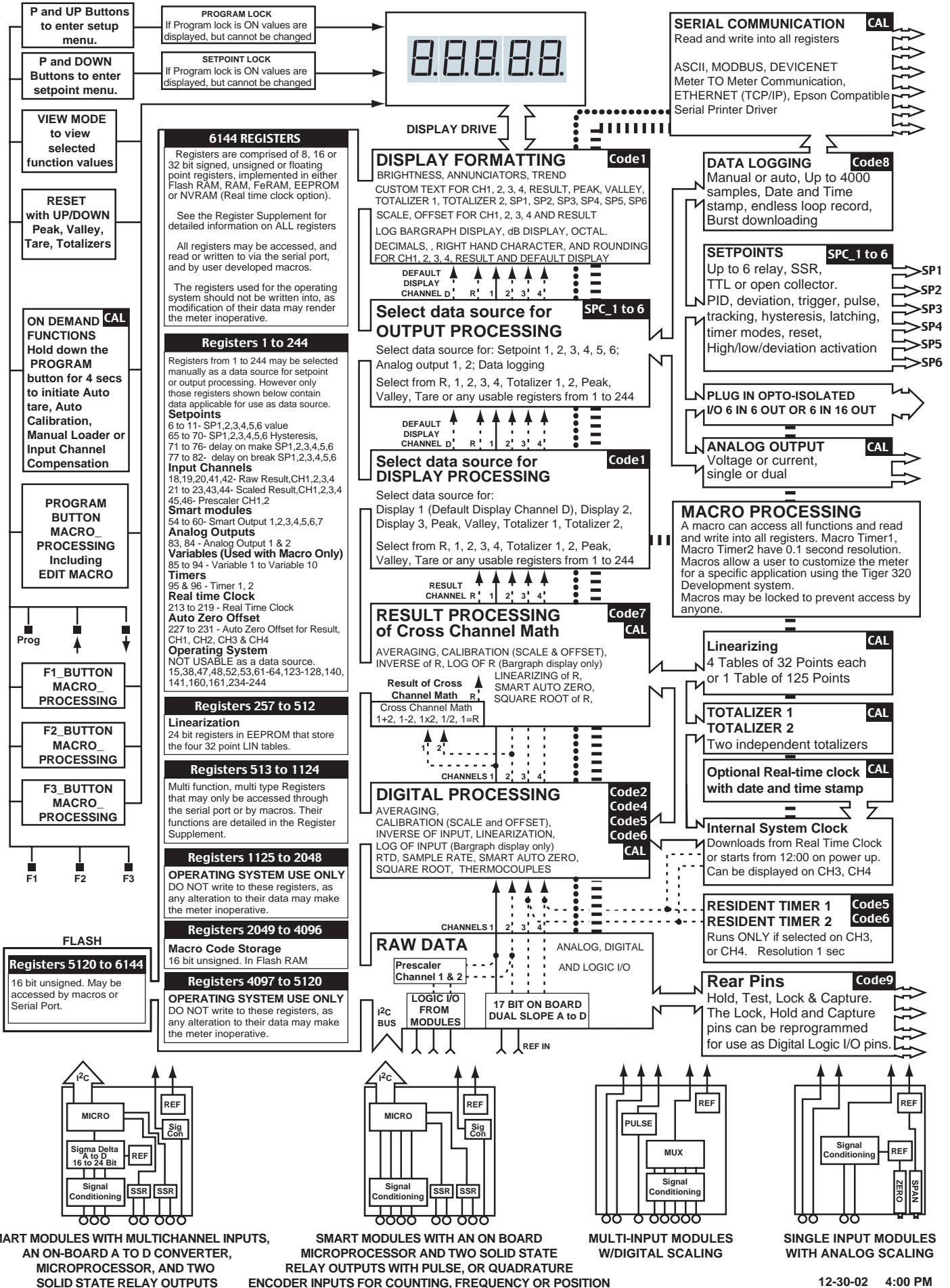

The Easiest and Fastest Way to Configure the Tiger 320 is to Use a PC with the Free Downloadable Configuration Utility Program

The diagrams and instructions provided in this data sheet / user manual are intended to enable the Tiger meter to be configured and programmed manually using the front panel buttons. A system of Programming Codes is required to facilitate this type of manual programming and these are explained in detail with diagrams and examples.

However, when the Tiger meter is configured and programmed via the optional RS-232 serial port and a PC using the Configuration Utility, the system of Programming Codes is bypassed. The Configuration Utility enables all the programming options to be clearly identified by their functions for direct on-screen selection. The Configuration Utility requires that an RS-232 interface board be installed in a Tiger 320 for programming. However, if the final application does not require a serial output, the RS-232 board can be easily removed, after programming is completed, and kept for future use.

The Configuration Utility Program (which may be freely downloaded from the web) is designed to simplify and speed up the configuration and programming of any Tiger 320. Pull down menus facilitate the selection of different options and the assignment of values. A "Help" explanation is provided just by holding the cursor over any function box.

The configuration utility enables the user to access some special capabilities of the Tiger 320 which cannot be selected manually by the front panel buttons.

Date (YYMM)	Serial No.	Input	Output
9937	1	0	0
9937	2	10000	10000
9937	3	20000	20000
9937	4	30000	30000
9937	5	40000	40000
9937	6	50000	50000
9937	7	60000	60000
9937	8	70000	70000
9937	9	80000	80000
9937	10	90000	90000
9937	11	100000	100000
9937	12	110000	110000
9937	13	120000	120000
9937	14	130000	130000
9937	15	140000	140000

Easy Installation of Linearization Tables

The configuration utility facilitates the storage and downloading of complex linearization tables. Tables can be created in any mathematical or spreadsheet program, and copied into the utility. Linearization tables can be created to precisely match a particular sensor so that they can be installed and downloaded as part of an annual calibration procedure.

Source For Display
 OFF Primary Display
 Result Channel 1
 Channel 2
 Channel 3
 Channel 4
 Totalisator 1
 Totalisator 2
 Peak
 Valley
 Tare
 Setpoint 1
 Setpoint 2
 Setpoint 3
 Setpoint 4
 Setpoint 5
 PID 1
 PID 2
 Register

Annunciators
 Annunciators On - Relay ON
 Annunciators On - Relay OFF
 Annunciators OFF
 Annunciators show tendency

Display Mode
 Normal Display Mode
 Manual Display Mode
 Fast Display Mode

Decimals and Display Format
 No decimal point
 X.X
 X.XXX
 X.XXXX
 X.XXXXX
 External decimal point
 12 Hour Clock
 24 Hour Clock
 Hrs : Mins : Secs
 Day : Hrs : Mins
 Octal

Last Digit Rounding
 None
 2 x
 5 x
 10 x

Right Hand Side Character

Source For Peak and Valley
 OFF Primary Display
 Result Channel 1
 Channel 2
 Channel 3
 Channel 4
 Totalisator 1
 Totalisator 2
 Peak
 Valley
 Tare
 Setpoint 1
 Setpoint 2
 Setpoint 3
 Setpoint 4
 Setpoint 5
 PID 1
 PID 2
 Register

Code Blanking
 Check only the codes you want to see

Display Text Editing
 Edit display text to suit your application

Code Blanking

When a custom configuration is created for any specialized application, the Tiger 320 can be programmed to blank out and disable all or any manual programming codes that you do not wish the user to be able to view or access by de-selecting them in the appropriate check box.

Display Text Editing

The meter can be programmed to display customized text to appear for any setpoint or event to suit any application requirements.

Source For Setpoints 1-6
 OFF Primary Display
 Result Channel 1
 Channel 2
 Channel 3
 Channel 4
 Totalisator 1
 Totalisator 2
 Peak
 Valley
 Tare
 Setpoint 1
 Setpoint 2
 Setpoint 3
 Setpoint 4
 Setpoint 5
 Setpoint 6
 PID 1
 PID 2
 Register

Destination
 OFF Primary Display
 Result Channel 1
 Channel 2
 Channel 3
 Channel 4
 Totalisator 1
 Totalisator 2
 Peak
 Valley
 Tare
 Setpoint 1
 Setpoint 2
 Setpoint 3
 Setpoint 4
 Setpoint 5
 Setpoint 6
 PID 1
 PID 2
 Register

Latching For Setpoints 1-6
 Latch ON
 Latch OFF

Activation For Setpoints 1-6
 Above
 Below

Mode For Setpoints 1-6
 OFF
 Normal
 One Shot
 Pulse Repeat

Timer For Setpoints 1-6
 Time (s)

Reset Mode
 Reset Value
 Constant
 Input SP+Const.
 Dest.+Const.
 Display
 Result
 Channel 1
 Channel 2
 Channel 3
 Channel 4
 Totalisator 1
 Totalisator 2
 Peak
 Valley
 Tare
 PID 1
 PID 2
 Register

Easy Setpoint Configuration

The Tiger 320 supports an incredible range of setpoint options and functions. The utility makes it quick and easy to select and download any combination you may require.

Configuration Data Copying and Loading

The configuration utility program allows you to store a record of a meter's configuration for later referral, or for the restoration of a desired configuration. Macros can be combined with a configuration file so they can be downloaded together and locked at the same time. When a file is locked after downloading, it cannot be copied. It can only be erased and reloaded from a master file.

Also included is the ability for the user to make notes about the configuration that can be stored as part of the file.

Never Before has the Customization of such a Powerful Measurement, Control and Automation Product been Made so Fast, Free and Easy

The Tiger 320 Macro Development System is so power packed and feature rich that you can build a completely custom designed controller in 1/50th of the time it would take to program a microprocessor or a PC, and 1/20th of the time it can take to program a PLC.

Quickly convert any special metering or control and automation idea into your own proprietary product, CE approved and ready to ship in days, with custom multicolor faceplates, labels, shipping boxes and instruction manuals.

This powerful, easy to use Development System can be downloaded free from the web. It enables programs to be written in BASIC, which can utilize any combination of the hundreds of functions and thousands of registers embedded in the Tiger 320 Operating System.

When your BASIC program is compiled into the Tiger 320 Macro-language it is error checked and optimized. When your Macro is downloaded into a Tiger 320 and locked, it is locked forever. It cannot be read or duplicated, it can only be erased. There is no back-door access. A Tiger 320 running your Macro will remain your exclusive proprietary product.

There is also a growing library of off-the-shelf application specific macro programs available. Many only need the blanks to be filled in to use them and this does not require any knowledge of BASIC. The source code is provided with these programs so they can easily be customized and/or integrated into any proprietary application-specific Macro.

On request, any custom Macro can be issued a serial number and pre-installed at the factory to operate on power-up.



Scrolling annunciator messages can be programmed to appear with any setpoint activation, selected events or logic inputs. Easy to read, plain text prompts can be programmed to replace the manual programming codes and provide a user-friendly interface for any custom application.

Tiger Development System - Code Writing Screen

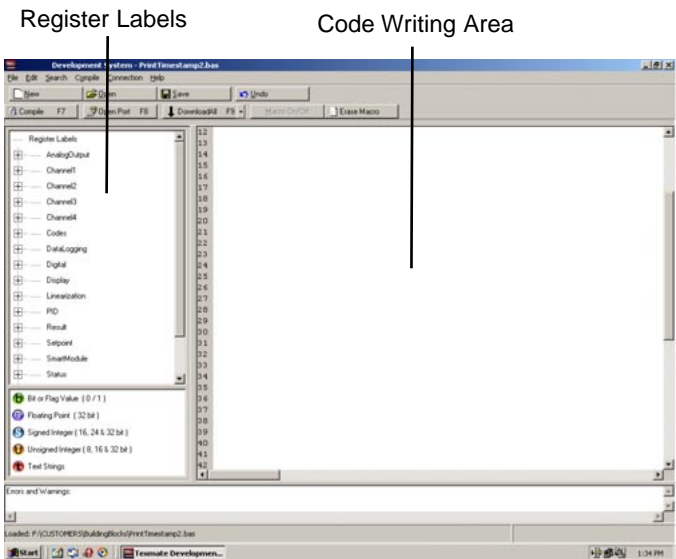

Tiger Development System screen showing Macro being written.

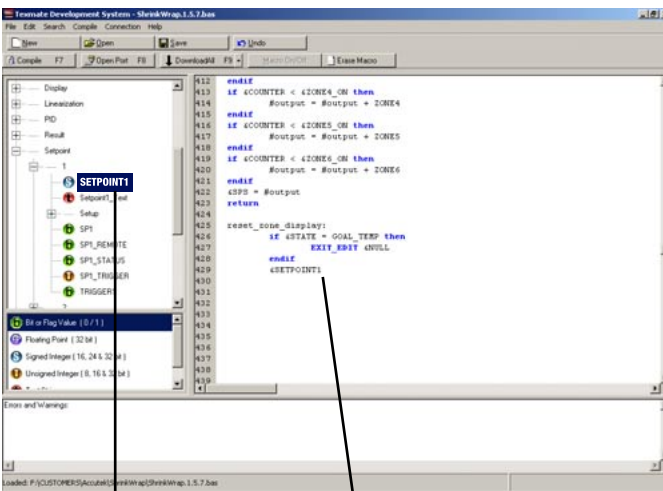

Double clicking on register label in the left hand side frame automatically inserts the function in the code window at the cursor insertion point.

Tiger Development System screen showing the Macro code being compiled successfully.

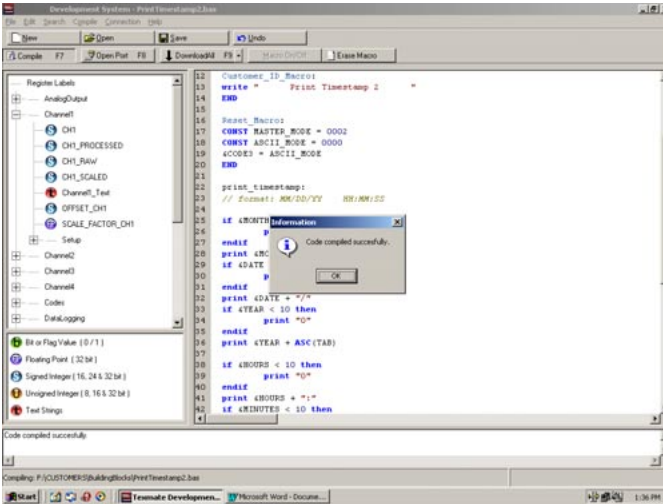

Tiger Development System screen showing the compiled Macro being downloaded into a Tiger 320 Series PMC.

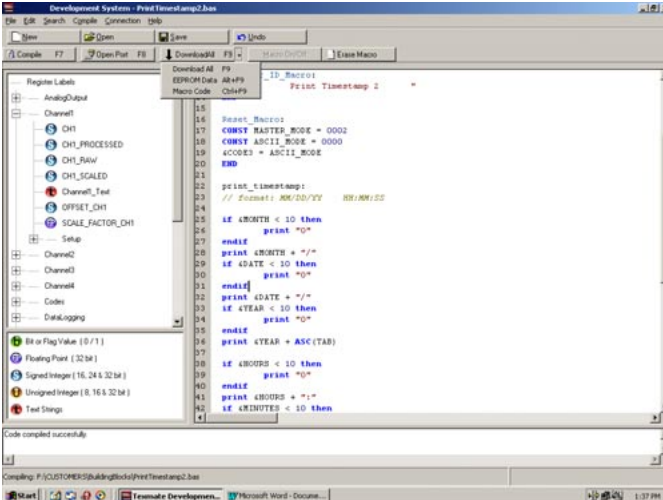

32-Bit Operating System	4	Code 9 - Functions for Digital Input Pins.....	37
Analog Output / Analog Retransmission	21-22	Code Blanking.....	19-20
Calibration of Analog Output.....	21	Clock/Timer	
Dual (0-10V) Analog Output	21	Configuration.....	31, 34, 35
Location of Analog Output Module	47	Optional Real-time Clock	4
Pinout of Analog Output	46	Real-time Clock Configuration	31, 34, 35
Scaling of Analog Output	21, 22	Real-time Clock Date	37
Select Source for Analog Output	21	Time Stamp.....	37
Auto Zero Maintenance for Weighing Applications.....	22	Component Layout & External Devices	47-48
Set Parameters for CH1, CH2, CH3 & CH4	21	Modular Construction	47
Averaging - Digital Filtering.....	22	Component Layout	48
Set Parameters for CH1, CH2, CH3 & CH4	21	Configuration and Programming from a PC	4, 8
Block Diagram of Software & Hardware.....	9	Configuration Utility Program	
Brightness Display	20	Code Blanking and Display Text Editing	10
Calibration	21-24	Configuration Data Copying	10
Calibration Thermocouple or RTD	21	Installation of Linearization Tables	10
Manual Calibration	23	Setpoint Configuration	10
Single-Point Calibration.....	23	Connections	
Two-Point Calibration	23	Carrier Board Output Pinouts	46
Case Dimensions	60	Connector Pinouts	45
Modular Construction	47	DeviceNet	46
Other Case Sizes	3, 4	External Devices	48
Channel 1 Settings	31-32	Ordering Information, Connectors	58
32 Point Linearization	32	Rear Panel Pinout Diagram	45
Analog Input Signal Sample Rate.....	31	Controls & Indicators	14-15
Counter/Resident Timer/Clock	31	Annunciator LEDs.....	14
Measurement Task	31	Down Button	14
Post Processing	32	Error Message	15
Print Mode.....	32	LED Display	14
Sampling Rate	31	Program Button.....	14
Serial Mode.....	32	Program Lockout Switch.....	15
Smart Input Module	31	Scrolling Display Text Messaging	14
Channel 2 Settings	33	Setpoint Lockout Switch	15
Channel 3 Settings	34	Seven Segment LED Displays	14
Channel 4 Settings	35	Up Button	14
Channel 1 & Channel 2 Results Processing		Control Outputs	6-7
32 Point Linearization	36	Electromechanical Relays	
Maths Functions	36	or Solid State Control Outputs	6
Code 1 - Display Configuration.....	25-30	I/O Logic, Rear Panel or Breakout Box.....	7
Configure Data Source Procedure	27	PID or ON/OFF Control	7
Configure Display Format Mode Procedure	28	Retransmission 0-10V or 4-20mA.....	7
Configure Last Digit Text Char. Procedure	29	Custom Macro Programming	
Configure Setpoint Annunciators Procedure	30	Macro Compiling and Loading	11
Configure Update at Sample Rate Procedure	30	Data Logging.....	4, 8, 37
Data Source - 2nd Digit [X5X]	25	Downloading Logged Data from Meter	37
Display Format - 2nd Digit [X6X]	25	Flash Card Memory Module	8
Display Functions Mode	25	Printing Logged Data	37
Manual Loader Mode	25	Real-time Clock.....	8, 37
Setpoint Annunciators Mode.....	25	Development Software	
Text Character - 2nd Digit [X7X].....	25	When to Use Macros	8
Update Display at Selected Sample Rate.....	25	DeviceNet.....	8, 46
Code 2 - Channel 1 Measurement Task		Digital Input Pins	37
and Sampling Rate	31	Display Brightness Setting	20
Code 3 - Channel 1 Post Processing		Display Functions.....	25-30
and Serial Mode Functions	32	Data Source	27
Code 4 - Channel 2 Measurement Task		Display Format and Decimals.....	28
and Sampling Rate	33	Display Rounding	28
Code 5 - Channel 3 Functions.....	34	Last Digit Text Character.....	29
Code 6 - Channel 4 Functions.....	35	Other Display Formats	4
Code 7 - Result Processing.....	36	Setpoint Annunciator Mode.....	30
Code 8 - Data Logging & Print Mode	37	Update at Sample Rate	30

Display Options	
LED or LCD Displays	6
Numeric or Alphanumeric Displays.....	6
Push Button or Membrane Touch Pads	6
Remote Display.....	6
Single or Multiple Displays	6
Faceplates	
Custom Faceplates	59
Optional Caption Sheets.....	59
Custom Faceplate Design Template	59
Filtering	
<i>See Averaging Samples & Averaging Window</i>	
Front Panel Controls	4, 14-15
Front Panel Programming Codes	17-18
Main Programming Mode	17
On Demand Modes.....	18
Setpoint Programming Mode	17
View Modes	18
Functional Diagram	45
General Features	1
HMI Touch Panel Graphic Displays	7
Hysteresis and Deviation	39-40, 42
Initial Setup Procedures.....	19-20
Code Blanking and Macro Check	19-20
Model and Software Code Version Check	19
Input Signal Conditioning Modules	5, 49-55
Input Module Component Glossary	55
Input Module Index	49
Input Modules	50-54
Modular Position	47
Ordering Information, Input Modules	56-57
Input Signals & Sensors	
4-20mA or Sensor Direct	6
Sensor Linearization or Compensation.....	6
I/Os (Opto Isolated & Logic Ports)	5, 48
Linearization	
Channel 1 Temperature Sensors	31
Channel 1 User Loaded Tables.....	32
Channel 2 Temperature Sensors and User Loaded Tables	33
Channel 3 Temperature Sensors and User Loaded Tables	34
Channel 4 Temperature Sensors and User Loaded Tables	35
Result of CH1 & CH2 User Loaded Tables.....	36
Table Settings	22, 36
Literature Overview	
Model Specific Data Sheets / User Manuals	3
Other Tiger 320 Series Related Software.....	3
Programming Code Sheet	3
Supplements to Data Sheets / User Manuals.....	3
Macros	4, 8, 11
Macro Check.....	19-20
Manual Loader	25
Maths Function	
Cross Channel Maths	9, 36
Result Processing.....	36
Modbus	7, 22
Model Type Check.....	19
On Demand Functions	21
Ordering Information	56-58
Panel Cutout	60
PID Control Settings.....	39, 42
Power Supply	5, 45
Prescaling	
Channel 1	31
Channel 2	33
Print Mode	7, 32
Programming Codes.....	17-18
Programming Conventions	16
Programming via PC	4, 10-11
Registers	
Registers That Can Be Selected	44
Registers That Should Not Be Selected	44
Resetting and Incrementing Using Setpoints	44
Relay & Logic Output Modules	46
Serial Communication	5, 7-8
ASCII.....	7
Configuration.....	32
DeviceNet	8
Ethernet	7
Master Mode	7
Modbus	7
Pinouts	46
Print Mode.....	7
RS-232 or RS-485	7
Setpoint Programming Mode.....	38-43
Data Logging.....	39
Data Printing to PC.....	39
Data Printing to Serial Printer.....	39
Display Flashing	39
Hysteresis or Deviation.....	39-40, 42
Level 1 - Basic Mode - Prog. Procedures	41
PID Control Settings	39, 42
Real-time Clock Option	39
Real Time Control Modes	40
Relay Energize Functions	39
Relay Output Modules	38
Setpoint & Relay Control Settings	38, 42
Setpoint Activation Source	39
Setpoint Activation Values.....	38
Setpoint Latching	39
Setpoint Reset & Trigger	39, 43
Setpoint Tracking.....	39
Timer Modes	39, 43
Smart Input Modules	
Setting Up	31
Supplements	
<i>See Literature Overview</i>	
Table of Contents	1
Timers	5, 39
Configuration.....	31, 34, 35
Delay Settings.....	43
Modes	40
Totalizers	
Setting.....	21-22

Front Panel Controls and Indicators

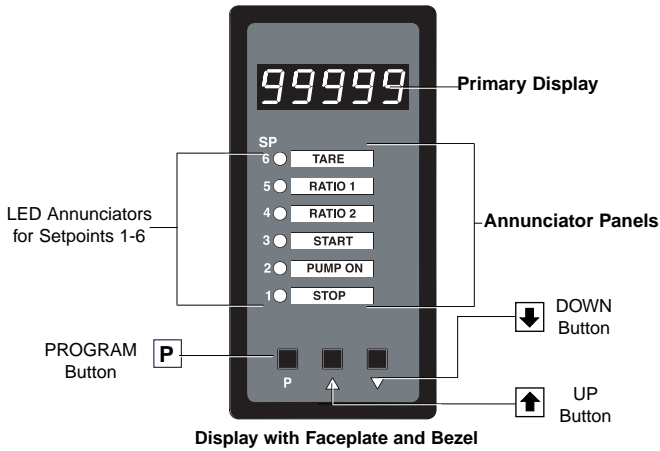

Program Button

While programming, pressing the **P** button saves the current programming settings and moves to the next programming step.

You can move through the programming codes using the program button. The codes you pass are not affected, unless you stop and make changes using the **↑** or **↓** buttons.

Pressing the **P** and **↑** button at the same time initiates the **main programming mode**. To save a new configuration setting and return to the operational display, press the **P** button once and then press the **P** and **↑** button at the same time.

Pressing the **P** and **↓** button at the same time initiates the **setpoint programming mode**. To save a new configuration setting and return to the operational display, press the **P** button once and then press the **P** and **↓** button at the same time.

See *Display with Faceplate and Bezel diagram*.

Up Button

When setting a displayed parameter during programming, press the **↑** button to increase the value of the displayed parameter.

When in the operational display, pressing the **↑** button initiates a viewing mode that allows you to view the readings on **channels 1 and 3, setpoints 1, 3, and 5, peak, and total 1**. Once into the viewing routine, pressing the **↑** button moves through each displayed parameter.

See *Display with Faceplate and Bezel diagram*.

Down Button

When setting a displayed parameter during programming, press the **↓** button to decrease the value of the displayed parameter.

When in the operational display, pressing the **↓** button initiates a viewing mode that allows you to view the readings on **channels 2 and 4, setpoints 2, 4, and 6, valley, and total 2**. Once into the viewing routine, pressing the **↓** button moves through each displayed parameter.

See *Display with Faceplate and Bezel diagram*.

Annunciator LEDs

The annunciator LEDs can be programmed to indicate the alarm status.

Setpoint 1 can be configured to indicate the **rising** signal trend. Setpoint 2 can be configured to indicate the **falling** signal trend. They are labeled from left to right: SP1, SP2, SP3, SP4, SP5, SP6.

See *Display with Faceplate and Bezel diagram*.

LED Display

The DI-50AN6 has a 5-digit, 7-segment, 8 mm (0.31") standard red, or optional green or super-bright red, LED display. The LED displays are used to display the meter input signal readings. They also display the programming codes and settings during meter programming.

See *Ordering Information for further details*.

Annunciator Panels

The annunciator panels are green or custom colour 19 mm x 4 mm light bars. Each light bar can be customized to display application specific text using a stick-on overlay.

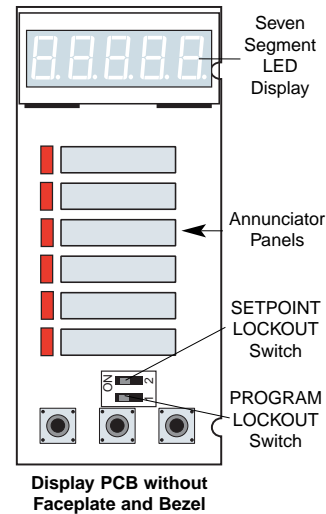

Display Text Editing with 7 Segment Alphanumeric Display Characters

Display text, such as setpoints, can be easily edited to suit your application, by connecting the meter to a PC running the free downloadable Configuration Utility program.

For Example:

Instead of [SP_1]

Instead of [SP_2]



OR

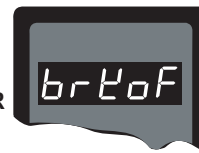

could be used for TANK LOW

could be used for BRAKE OFF

Scrolling Display Text Messaging

Scrolling display text messaging can be configured to run but requires a simple compiler generated macro.



Display Text Characters

The following text characters are used with the 7-segment display.

7-SEGMENT DISPLAY CHARACTERS

1	2	3	4	5	6	7	8	9	0
A	b	c	d	E	F	G	H	I	J
k	L	M	N	O	P	Q	R	S	
t	U	V	W	X	Y	Z			

Program Lockout Switch

When the PROGRAM LOCKOUT switch is set to position 2, all programmable meter functions can be changed.

When set to the ON position, the PROGRAM LOCKOUT switch prevents any programming changes being made to the meter. If programming is attempted, the meter displays [LoCk]. The ON position allows programming parameters to be viewed but not changed.

See *Display PCB without Faceplate and Bezel diagram*.

Setpoint Lockout Switch

When the SETPOINT LOCKOUT switch is set to position 1, the setpoints can be programmed. Once the setpoint values have been entered and the SETPOINT LOCKOUT switch set to the ON position, the setpoints can be viewed but not changed.

See *Display PCB without Faceplate and Bezel diagram*.

Error Message [Err]

Error messages usually occur during calibration procedures. The three most likely causes of an error message are:

- 1) The full scale and zero signals were too similar.
Note, the high input (full scale) signal must be at least 1000 counts greater than the low input (zero) signal (positive and negative values are allowed).
- 2) The scaling requirement exceeded the capability of the meter (-19999 to +99999).
- 3) No input signal present, or incorrect connections.

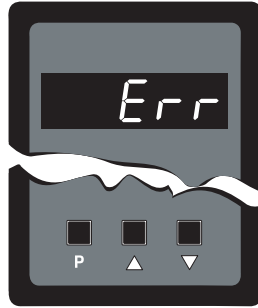

Display Showing [Err] Message

Rear Panel External Switched Inputs

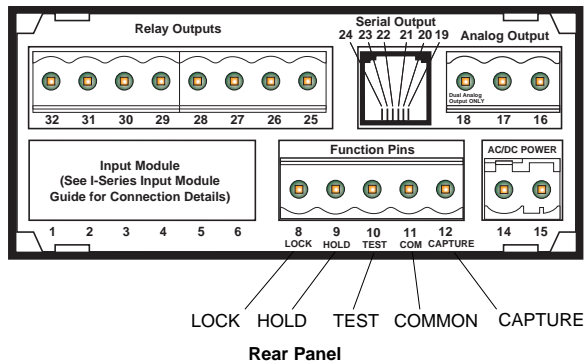

Rear Panel

Lock Pin

By configuring Code 9 to [XX0], connecting the LOCK pin (pin 8 on the main PCB) to the COMMON pin (pin 11 on the main PCB), locks out the main and setpoint programming modes. All meter programming codes and setpoints can be viewed but not changed.



Display Showing [LoCk] Message

The main programming mode can be entered, but only the brightness setting adjusted. After adjusting the brightness setting, pressing the [P] button displays [LoCk].

The LOCK pin can also be configured in Code 9 to carry out the following functions (see *Meter Programming Codes* on Page 17):

- Reset channel 1 [XX1].
- Reset channel 2 [XX2].
- Reset channel 3 [XX3].
- Reset channel 4 [XX4].
- Reset tare [XX5].
- Reset total 1 [XX6].
- Unlatch (de-energize) all setpoints [XX7].

Hold Pin

Configure Code 9 to [X0X]. When the HOLD pin (pin 9) is connected to the COMMON pin (pin 11) the displayed reading is frozen. However, A/D conversions and all control functions continue and as soon as pin 9 is disconnected from pin 11 by the switch, the updated reading is instantly displayed.

The HOLD pin can also be configured in Code 9 to carry out the following functions (see *Meter Programming Codes* on Page 17):

- Reset channel 1 [X1X].
- Reset total 1 and total 2 [X2X].
- Reset total 2 [X3X].
- Reset peak and valley [X4X].
- Reset tare [X5X].
- Set tare [X6X].
- Unlatch (de-energize) all setpoints [X7X].

Test Pin

Configure Code 9 to [0XX]. When the TEST pin (pin 10) is connected briefly to the COMMON pin (pin 11) all segments of the display and setpoint annunciators light up. Six eights and six decimal points (8.8.8.8.8.8.) are displayed for a short period. The microprocessor is also reset during this time, losing all RAM settings such as peak and valley, and any digital input pin settings set up in Code 9.

The TEST pin can also be configured in Code 9 to carry out the following (see *Meter Programming Codes* on Page 17):

- Reset counter channel 1 and total 2 at power-up [1XX].
- Reset counters, CH1, CH2, CH3, CH4, total 1, and total 2 at power-up [2XX].
- Reset total 1 and total 2 at power-up [3XX].

Capture Pin

When the CAPTURE pin (pin 12) is connected to the COMMON pin (pin 11), the CAPTURE pin can be programmed for setpoint/relay activation or macro control applications in the setpoint control settings mode of the setpoint programming mode [SPC_X] [X2X].

Common Pin

To activate the LOCK, HOLD, TEST and CAPTURE pins from the rear of the meter, the respective pins have to be connected to the COMMON pin (pin 11).

Front Panel Push Button Configuration and Setup for Programming Conventions

The meter uses a set of intuitive software codes to allow maximum user flexibility while maintaining an easy programming process. To configure the meter's programming codes, the meter uses the three right-hand side display digits. These are known as the 1st, 2nd, and 3rd digits and can be seen in the diagram opposite. To explain software programming procedures, diagrams are used to visually describe the programming steps. The following conventions

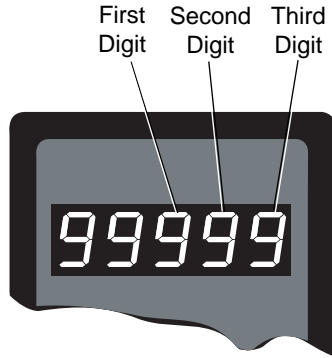

are used throughout the range of Tiger 320 Series document diagrams to represent the buttons and indicators on the meter, and the actions involved in programming the meter:

Symbol

Explanation



The display showing 99999 represents the **OPERATIONAL DISPLAY**. After the meter has been powered up, the display settles and indicates the calibrated input signal. This is known as the operational mode and is generally referred to as the operational display throughout the documentation.

All programming modes are entered from this level.



This symbol represents the **PROGRAM** button. In a procedure, pressing the program button is always indicated by a **left hand**. A number indicates how many times it must be pressed and released, or for how long it must be pressed before releasing.

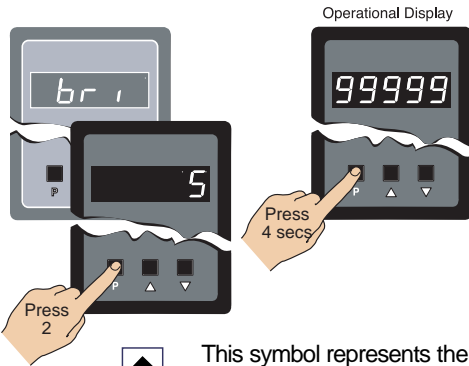

This symbol represents the **UP** button. Shown in a diagram, pressing the UP button is always indicated by a **right hand**.



This symbol represents the **DOWN** button. Shown in a diagram, pressing the DOWN button is always indicated by a **right hand**.

Where two right hands are shown on the same diagram with the word OR between them, this indicates that both the UP and DOWN buttons can be used to adjust the display: UP for increase, DOWN for decrease.

[Span]
[10000]

Text or numbers shown between square brackets in a description or procedure indicate the programming code name of the function or the value displayed on the meter display.

Programming procedures are graphic based with little descriptive text.

Each procedure shows a number of meter panel displays running in procedural steps from the top to the bottom of the page.

If need be, the procedure may run into two columns with the left column running down the page and continuing at the top of the right-hand column. Each action performed by the user is shown as a numbered step.

Each procedural step shows the meter display as it looks before an action is performed. The hand or hands in the procedural step indicate the action to be performed and also how many times, or for how long, the button is to be pressed.

For example, the diagram below shows the meter in the operational display. With a left hand pressing the [P] button and a right hand pressing the [UP] button, the user is entering the **main programming mode**. This is indicated by the next diagram displaying [br 1] and [5]. This is the display brightness mode and is the first sub-menu of the main programming mode. Operational Display

Step 1

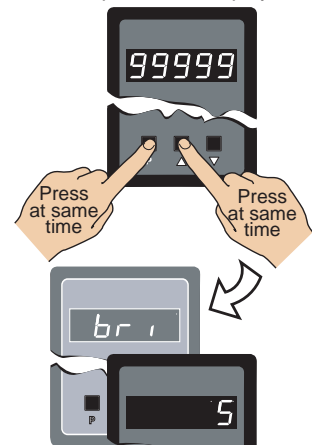

Step 2



Where a left and right hand are shown on separate buttons on the same diagram, this indicates that the buttons must be pressed at the same time.

The only exception to this rule is when carrying out the *Model and Software Code Version Check*.

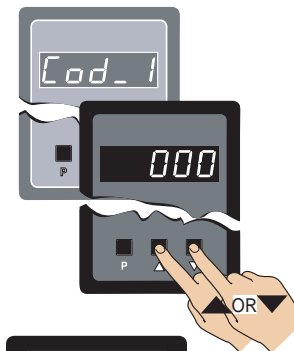

When two displays are shown together as black on grey, this indicates that the display is toggling (flashing) between the name of the function and the value or configuration setting.

Where a number is not definable, the default setting [000] is shown.

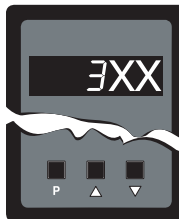

If an X appears in the description of a 3-digit programming code or in a configuration procedure, this means that any number displayed in that digit is not relevant to the function being explained, or more than one choice can be made.

Front Panel Programming Codes

The meter's programming codes are divided into two modes: the **main programming mode**, and the **setpoint programming mode** (See diagram below).

Each mode is accessible from the operational display.

Main Programming Mode

The main programming mode provides access to program all meter functions, except setpoints.

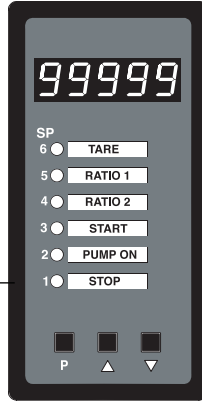

Programming Tip

The easiest and fastest way to configure the Tiger 320 is to use a PC with the free downloadable configuration utility program. (see page 10)

Setpoint Programming Mode

The setpoint programming mode provides access to program all setpoint and relay functions.

To enter or exit the Main Programming Mode, press **P** and **↑** at the same time

Main Programming Mode

[br] Display Brightness

P

[CAL] Calibration Modes for Input and Output

P

[Cod_1] Code 1 – Display Configuration

P

[Cod_2] Code 2 – CH1 Measurement Task & Sampling Rate

P

[Cod_3] Code 3 – CH1 Post Processing & Serial Mode Functions

P

[Cod_4] Code 4 – CH2 Measurement Task & Sampling Rate

P

[Cod_5] Code 5 – CH3 Functions

P

[Cod_6] Code 6 – CH4 Functions

P

[Cod_7] Code 7 – Result Processing

P

[Cod_8] Code 8 – Data Logging & Print Mode

P

[Cod_9] Code 9 – Functions for Digital Input Pins

P

[Cod10] Code 10 – Bargraph Setup

P

Code 10 applies to Tiger 320 Series meters with bargraph displays only. See user manuals for DI-50B51, FI-B101D50, and GI-50B101.

To enter or exit the Setpoint Programming Mode, press **P** and **↓** at the same time

Setpoint Programming Mode

Setpoint Activation Values Mode

Enter these menus to adjust SP activation values

[SP_1] Setpoint 1

P

[SP_2] Setpoint 2

P

[SP_3] Setpoint 3

P

[SP_4] Setpoint 4

P

[SP_5] Setpoint 5

P

[SP_6] Setpoint 6

Setpoint & Relay Control Settings Mode

Enter these menus to configure SP control values

[SPC_1] Setpoint 1

P

[SPC_2] Setpoint 2

P

[SPC_3] Setpoint 3

P

[SPC_4] Setpoint 4

P

[SPC_5] Setpoint 5

P

[SPC_6] Setpoint 6

P

P



Programming Tip

Save SP Settings & Exit

To save a new setpoint configuration setting and return to the operational display at any point, press the **P** button once.

Then press the **P** and **↓** button at the same time to exit.



Programming Tip

Save Code Settings & Exit

To save a new main programming mode configuration setting and return to the operational display at any point, press the **P** button once.

Then press the **P** and **↑** button at the same time to exit.

The *Setpoint and Relay Control Settings* diagram on Pages 42 and 43 shows the three digit configuration settings that are applied individually to each setpoint.

See Page 41 for an example procedure to configure a setpoint for simple relay functions.

View Modes

While in the operational display, pressing the **▲** button allows you to view but not change the following parameters:

- Channel 1.
- Channel 3.
- Setpoint 1.
- Setpoint 3.
- Setpoint 5.
- Peak (of CH1).
- Total 1 (total of CH1).

While in the operational display, pressing the **▼** button allows you to view but not change the following parameters:

- Channel 2.
- Channel 4.
- Setpoint 2.
- Setpoint 4.
- Setpoint 6.
- Valley (of CH1).
- Total 2 (total of CH2).

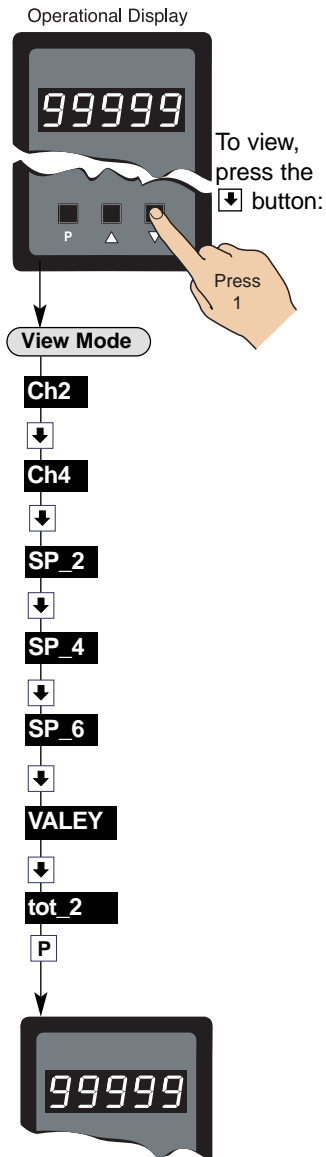
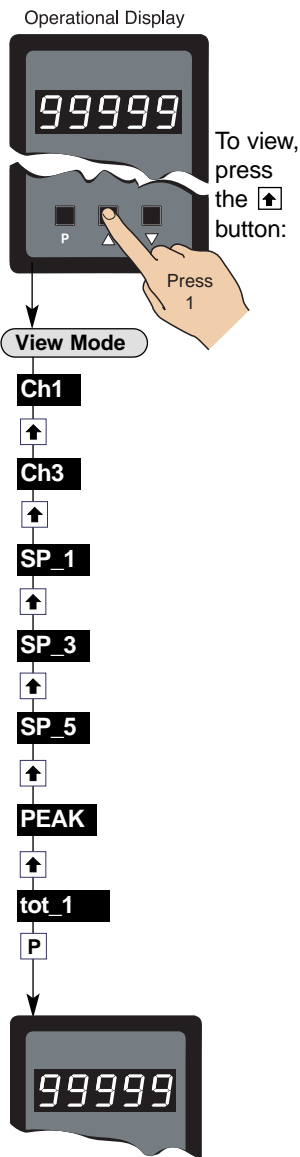

On Demand Modes

The meter can be programmed to activate the following functions on demand by pressing the **P** button for 4 seconds:

- Tare.
- Single-point calibration.
- Two-point calibration.
- Primary input compensation.
- Manual loader (manual offset).
- Print.

The on demand function is selected in the calibration mode.

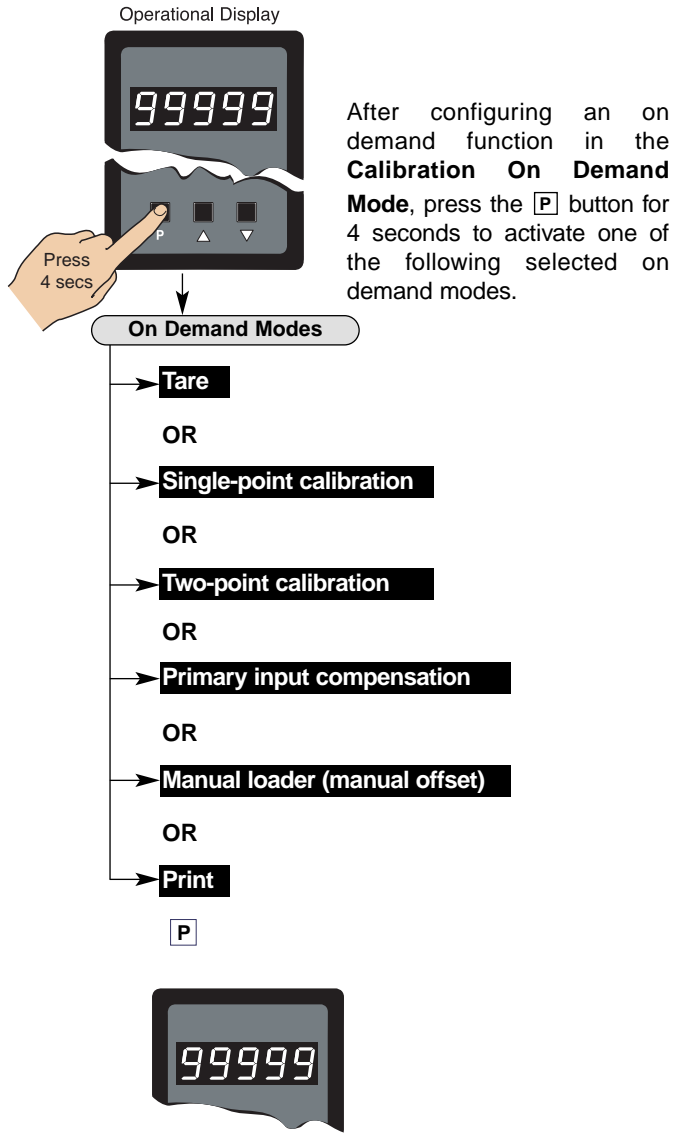

After configuring an on demand function in the **Calibration On Demand Mode**, press the **P** button for 4 seconds to activate one of the following selected on demand modes.

For a full breakdown of all programming codes, see the *Tiger 320 Series Programming Code Sheet (NZ101)*. See page 3 for more information.

Initial Setup Procedures

Before configuring the meter, carry out the following meter configuration checks:

- Model and software code version check.
- Code blanking and macro check.

After powering-up the meter, check the model and software code version number and note this in your user manual.

Model and Software Code Version Check

The meter model and software code version number can be checked at any time while in the operational display using the following procedure.

START HERE

MODEL & SOFTWARE CODE VERSION CHECK

Step 1

Press and hold the and buttons

Operational Display

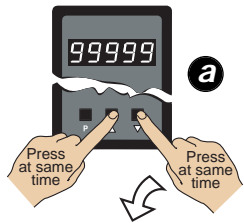

Step 2

While holding both buttons, press the Prog. button then release all three buttons

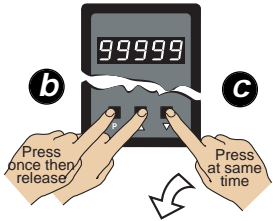

Example

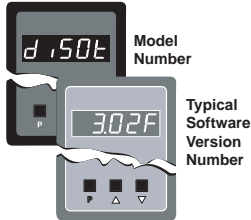

Step 3

The displays toggle three times. If a macro is installed and turned on, the customer ID and the macro ID scroll across the display before returning to the operational display.



Model No:
 Software Version No:
 Customer ID:
 Macro ID:



Programming Tip

The *Model and Software Code Version* checking procedure can be performed at any time without interfering with other configuration settings.

Code Blanking and Macro Check

Tiger 320 Series meters have the ability to hide (blank out) all or some programming codes, making them tamper-proof. This can only be done using the Meter Configuration program.

With code blanking turned ON, all main and setpoint codes that have been blanked out during factory programming are hidden, preventing them from being reprogrammed. Any codes that have not been blanked out are still visible and can be reprogrammed.

Turning code blanking OFF means all meter programming codes are visible when you enter the programming modes and can be reprogrammed.

A macro is a set of commands that run automatically when the meter is powered up. We have a growing library of macros to suit a wide range of standard customer applications.

Macros can be installed in the meter at the factory during initial programming or by the customer at some later date. Macros are written and compiled using the BASIC Compiler program, and loaded into the meter using either the BASIC Compiler program or the Meter Configuration program.

Turning the macro OFF means that the meter will not perform the automatic commands pre-programmed to run with the macro.

Unless requested to blank out all or some programming codes and/or run a macro, we will program the meter in the code blanking OFF and macro OFF (default) setting.

To turn the code blanking and macro settings from ON to OFF:

START HERE

CODE BLANKING & MACRO CHECK PROCEDURE

Step 1

Press and hold the and buttons

Operational Display

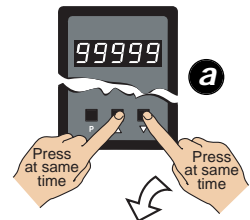

Step 2

While holding both buttons, press the Prog. button.

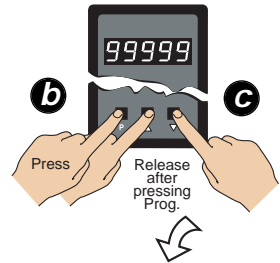

Step 3

Release the and buttons and hold the Prog. button for approx. 1 sec then release

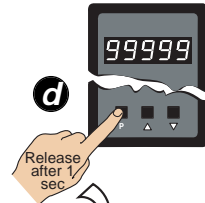

Example

NOTE: Unless otherwise requested, the factory default setting is off

Step 4

Press the button to switch code blanking OFF

Code Blanking & Macro Check Procedure continued on next page (Step 5)

Display Configuration

Once you have read the User manual and related supplements, and installed and powered-up the meter, configure the display to suit its designated application.

Display Brightness Mode

The **display brightness mode** is accessed when entering the main programming mode. It allows you to adjust the brightness of the display LEDs and setpoint annunciators without interfering with other configuration settings. It is always available, even with the PROGRAM LOCK switch set to ON, or the external LOCK pin connected to the COMMON pin, locking out the programming modes.

The display brightness can be set between 0 and 7, with 0 being dull and 7 being bright. The default setting is 5.

Example Procedure:

Configure the display brightness setting to 7 (bright).

START HERE

DISPLAY BRIGHTNESS MODE

Step 1

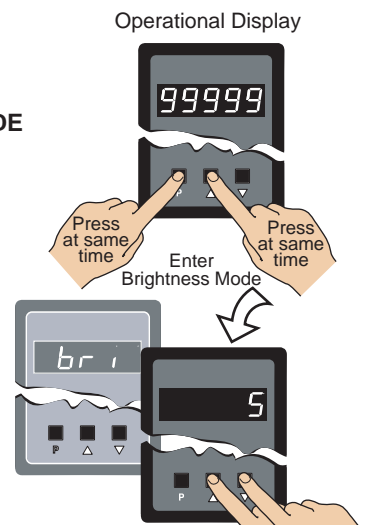

Step 2

Adjust brightness to 7

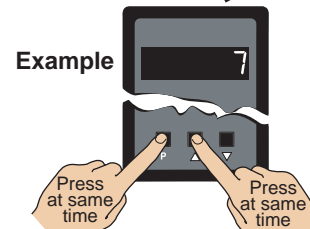

Step 3

Save brightness setting. Exit Brightness Mode. Return to Operational Display



Programming Tip

The *Display Brightness* setting procedure can be performed at any time without interfering with other configuration settings by entering the main programming mode.

continued from Step 4

Step 5

Press the Prog. button.

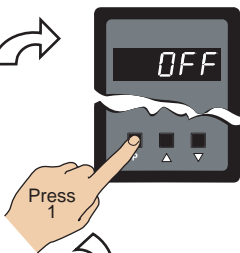

Example



NOTE: Unless otherwise requested, the factory default setting is OFF

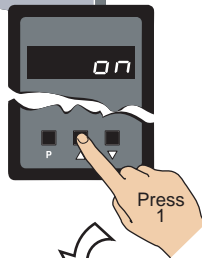

Step 6

Press the [M] button to switch the macro OFF



Step 7

Press the Prog. button.

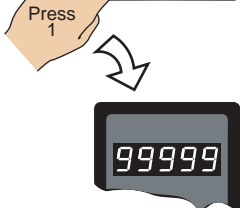

Programming Tip

Code Blanking and Macro ON/OFF settings revert to the meter's original configuration settings when the meter is powered off and on.

The Tiger 320 Series meter has an extremely powerful set of input and output calibration modes. See diagram below.

ON DEMAND Functions

In this mode the meter can be programmed to activate one of the following on demand functions by pressing the **[P]** button while in the operational display:

- On Demand TARE.
- On Demand Single-point Calibration (requires single input source).
- On Demand Two-point Calibration (requires dual input source).
- On Demand Primary Input Compensation Mode.
- On Demand Manual Loader Mode.

Calibration Modes

The following calibration modes are available:

- Manual Calibration (requires NO input source).
- **Two-point Calibration (requires dual input source).**
This is the calibration mode generally used to calibrate the meter for most applications. An example procedure has been included.
- Calibrate Thermocouple (requires K type thermocouple input source).
- Calibrate RTD (requires RTD 385 input source).
- Calibrate Smart Input Module (not available on all input modules).
- Calibrate Analog Output (requires multimeter connected to pins 16 and 17).

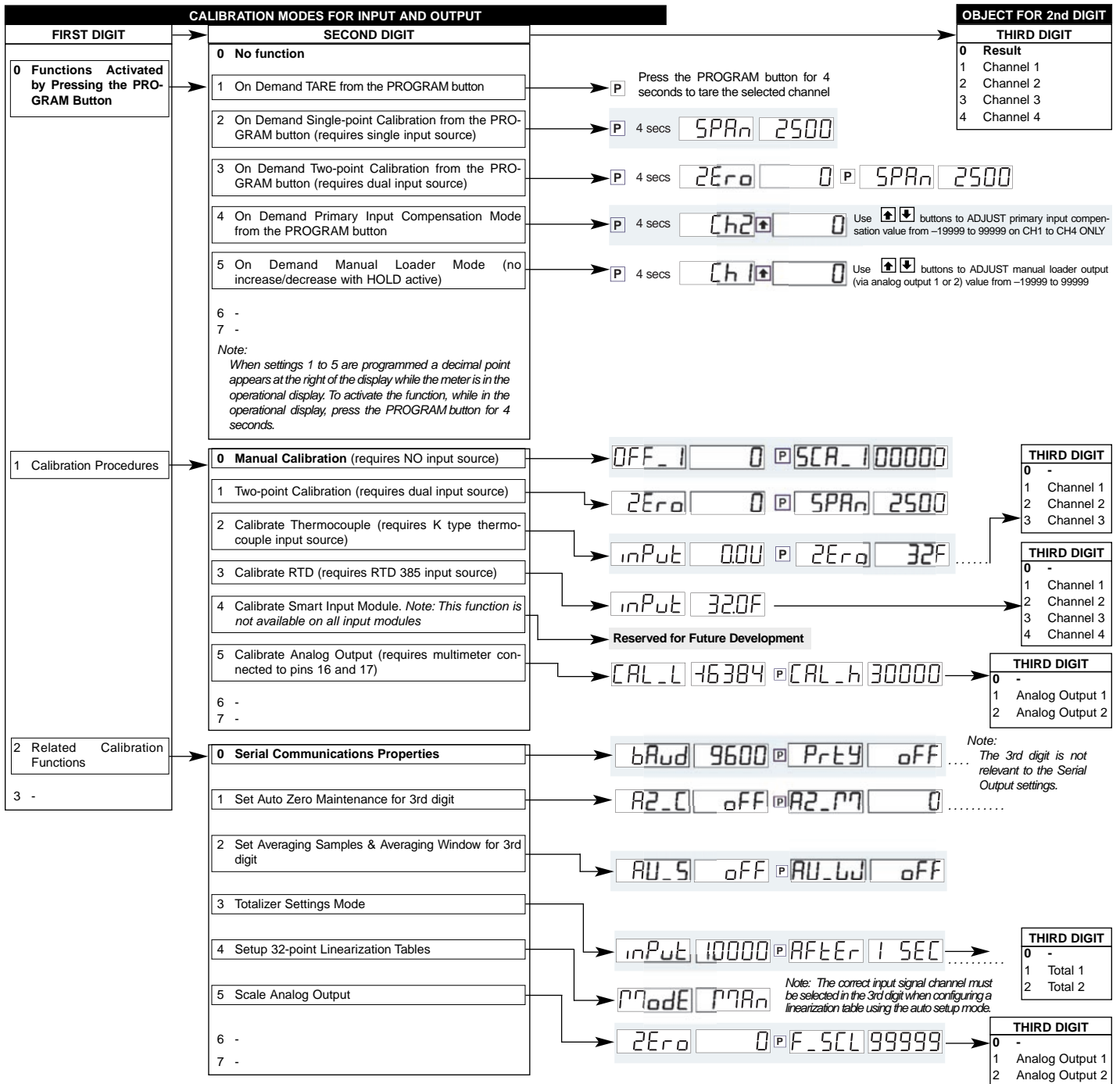

Related Calibration Functions

The following functions are also configured in the calibration mode. See *Advanced Calibration and On Demand Mode Supplement (NZ203)* for further calibration details. (See page 3 for more information).

Serial Communications Properties

Selecting [CAL][20X] enters the Serial Communications Properties Mode.

This mode allows you to configure the serial communications output module baud rate, parity, time delay, and address settings.

See the **calibration modes** diagram on Page 21 showing a breakdown of 1st, 2nd, and 3rd digits.

Also see the *Serial Communications Module Supplement (NZ202)* for further details on the serial communications module. (See page 3 for more information).

Set Auto Zero Maintenance

Selecting [CAL][21X] enters the Set Auto Zero Maintenance Mode.

This mode allows you to configure auto zero maintenance settings for weighing applications applied to the channel selected in the 3rd digit.

See the **calibration modes** diagram on Page 21 showing a breakdown of 1st, 2nd, and 3rd digits.

Set Averaging Samples & Averaging Window

Selecting [CAL][22X] enters the Set Averaging Samples and Averaging Windows Mode.

This mode allows you to configure the number of input signal samples to average over, and the size of the averaging window in display counts applied to the channel selected in the 3rd digit.

Selecting [CAL][22X] enters the Set Averaging Samples and Averaging Windows Mode. When in this mode, the [AV_S] menu allows you to select the number of input signal samples to average over. After setting the number of samples, moving to the [AV_W] menu allows you to configure the size of the averaging window in displayed counts.

The meter averages the input samples over the selected number of input samples (selected in the [AV_S] menu). This carries on in a continual process provided the input signal stays within the averaging window (set in the [AV_W] menu). If the sample moves out of the averaging window, the meter responds quickly to the change by displaying the non-averaged signal value. When the signal stabilizes, a new averaging window is established and averaging resumes.

You can program the number of samples you want to average the input signal over from 1 to 255 samples. The averaging window can be set to between 1 and 65535 counts.

See the **calibration modes** diagram on Page 21 showing a breakdown of 1st, 2nd, and 3rd digits.

See *Input Signal Sampling Showing Averaging Window* diagram opposite.

Example Procedure

The example procedure on Page 24 shows how to configure channel 1 (CH1) with an averaging sample rate of 10 counts and an averaging window of 1000 counts.

Totalizer Settings

Selecting [CAL][23X] enters the Totalizer Settings Mode.

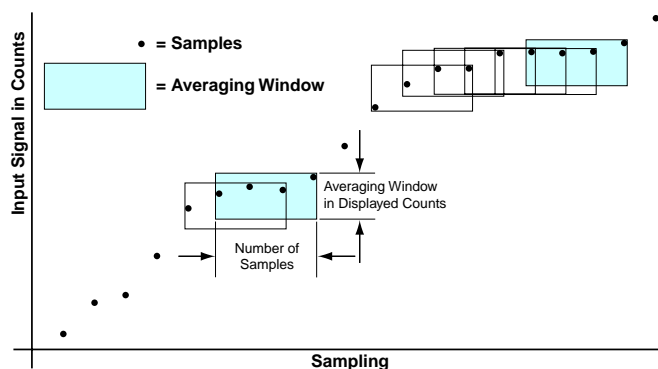

Input Signal Sampling Showing Averaging Window

This mode allows you to configure the settings for the totalizer selected in the 3rd digit. An input value of 10000 counts is applied to a selectable time period to produce the required total value.

The cutoff is a programmable limit below which the input is not totalized.

See the **calibration modes** diagram on Page 21 showing a breakdown of 1st, 2nd, and 3rd digits.

Also see the *Totalizing and Batching Supplement (NZ208)* for further details on K factor and totalizer cutoff parameters. (See page 3 for more information).

Setup 32-point Linearization Tables

Selecting [CAL][24X] enters the Setup 32-point Linearization Tables Mode.

This mode allows you to set up the linearization table or tables using the manual or auto setup modes. The table or tables can then be selected to linearize the signals on channels 1 to 4.

See **Linearization Table Notes** on Page 36 for a description of memory related issues with linearization.

See the **calibration modes** diagram on Page 21 showing a breakdown of 1st, 2nd, and 3rd digits.

Also see the *Linearizing Supplement (NZ207)* for further details on linearization table setup and use. (See page 3 for more information).

Scale Analog Output

Selecting [CAL][25X] enters the Scale Analog Output Mode.

This mode allows you to calibrate and scale the analog output signal. Before calibrating the analog output in the calibration mode, the data source for the analog output must be configured in Code 1.

See the **calibration modes** diagram on Page 21 showing a breakdown of 1st, 2nd, and 3rd digits.

Also see the *Analog Output Module Supplement (NZ200)* for further details on the analog output module. (See page 3 for more information).

Also see *Configure Data Source Procedure* on Page 27 for an example of setting the analog output data source.

Calibration Mode Procedures Supplement

The *Advanced Calibration and On Demand Mode Procedures Supplement (NZ203)* describes in detail all Tiger 320 Series meter related calibration procedures configured in the calibration mode.

Two-point Calibration

Two-point calibration is the most commonly used method of calibrating Tiger 320 Series meters when a low and high input source is available.

Example Calibration Procedure

Calibrate channel 1 (CH1) using the two-point calibration method. Set the calibration mode display to [111].

START HERE

TWO-POINT CALIBRATION

Step 1

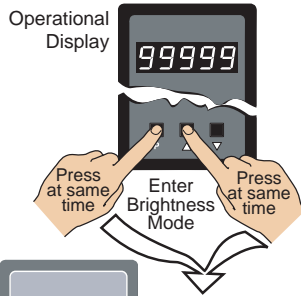

Step 2

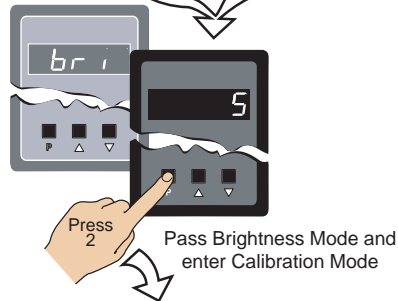

Step 3

Set Calibration Mode to [111]:
 1st Digit = 1
 Selects calibration procedures
 2nd Digit = 1
 Selects 2-point calibration
 3rd Digit = 1
 Selects CH1 for calibration

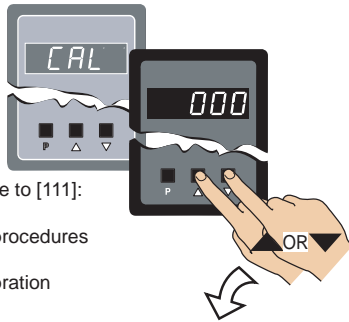

Step 4

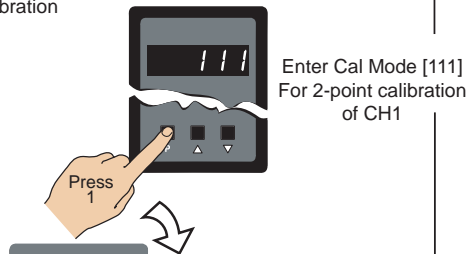

Step 5

5.1. Adjust display to desired reading for zero input
 5.2. Apply the LOW input signal

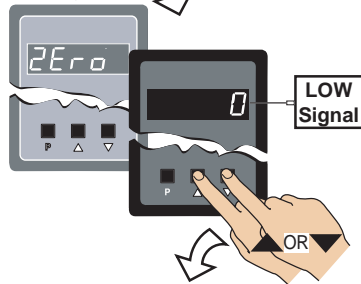

Step 6

Set reading for zero load into meter and enter Span Mode

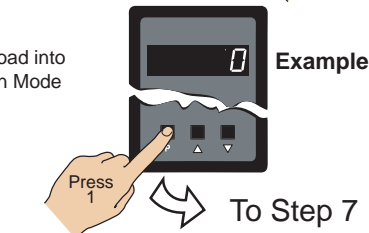

The low input source is applied to the meter when setting the zero value.

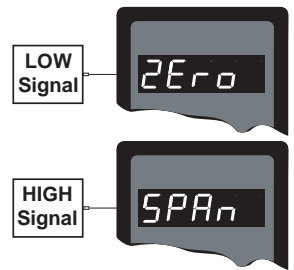

The high input source is applied to the meter when setting the span value.

Step 7

7.1. Adjust display to desired reading for span input
 7.2. Apply the HIGH input signal

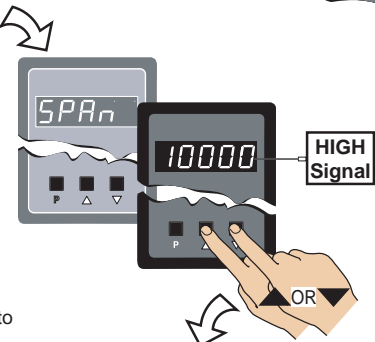

Step 8

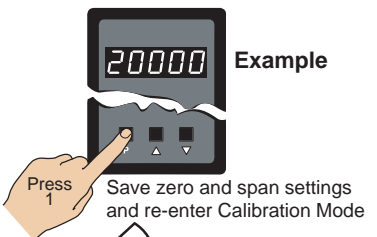

Step 9

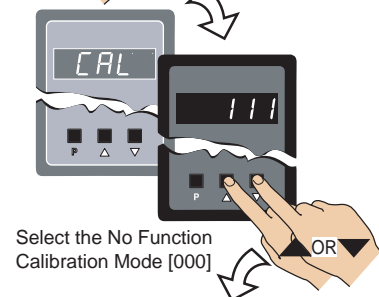

Step 10

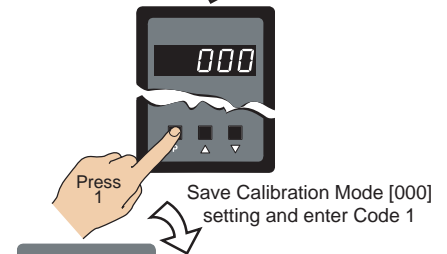

Step 11

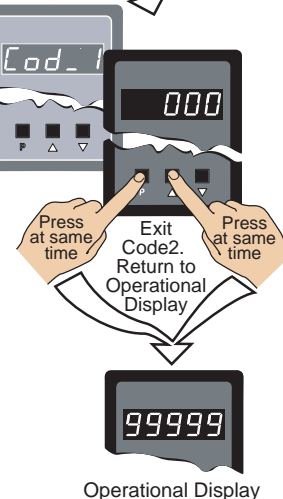

Input Signal Filtering and Averaging

Input signal filtering and averaging is configured in the calibration mode. Programmable averaging allows you to program the number of samples you want to average the input signal over (from 1 to 255 samples).

A programmable averaging window provides a quick response time to large input signal changes. The averaging window can be set to between 1 and 65535 counts.

Example Procedure:

Select an averaging sampling rate of 10 samples and an averaging window of 1000 counts for Channel 1 by setting [CAL] to [221].

See Advanced Calibration & On Demand Mode Supplement (NZ203) for further calibration procedures. (See page 3 for more information).

START HERE

INPUT SIGNAL FILTERING & AVERAGING

Step 1

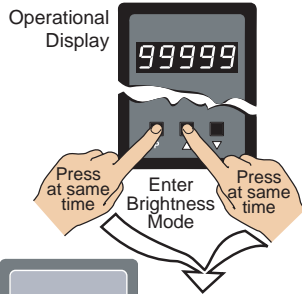

Step 2

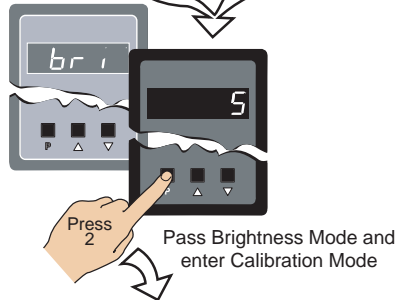

Step 3

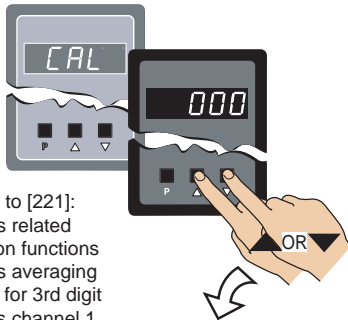

Set Calibration Mode to [221]:
 1st Digit = 2 Selects related calibration functions
 2nd Digit = 2 Selects averaging samples for 3rd digit
 3rd Digit = 1 Selects channel 1 for 2nd digit

Step 4

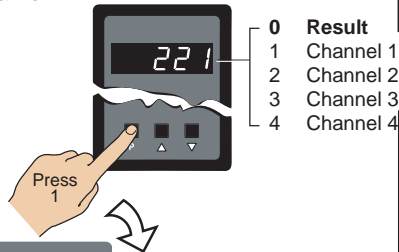

- 0 Result
- 1 Channel 1
- 2 Channel 2
- 3 Channel 3
- 4 Channel 4

Step 5

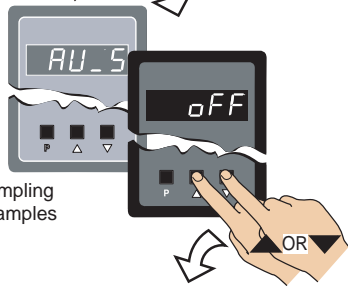

Select averaging sampling rate from 1 to 255 samples

Step 6

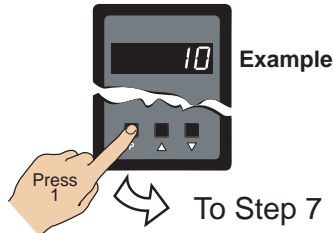

Save averaging sampling rate setting

From Step 6

Step 7

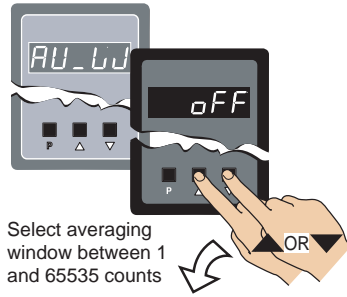

Select averaging window between 1 and 65535 counts

Step 8

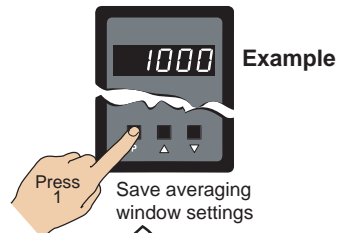

Step 9

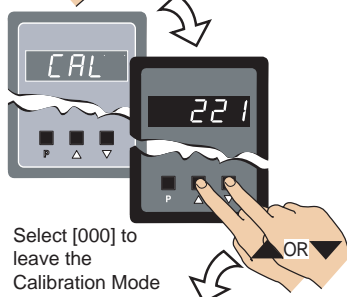

Select [000] to leave the Calibration Mode

Step 10

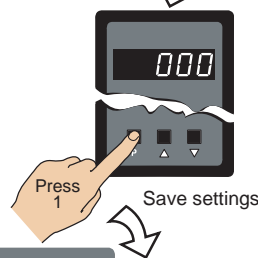

Step 11

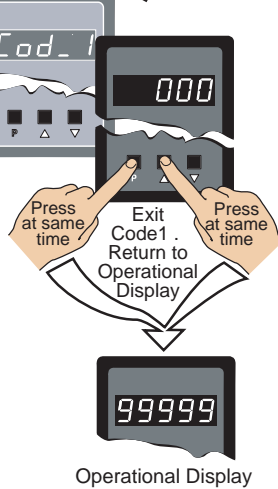

Operational Display

CODE 1 – Display Configuration Modes

All meter display modes, except the display brightness mode, are configured in Code 1 (See diagram below). See Code 1 diagram on Page 26 for a breakdown of 1st, 2nd, and 3rd digits settings.

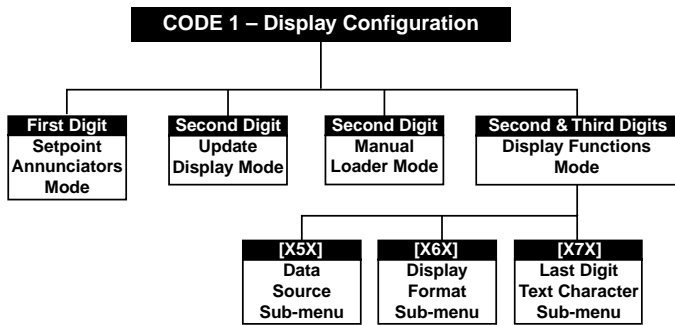

The top display is the primary display and is used during all meter configuration procedures, including configuring the second and third displays.

Setpoint Annunciators Mode

The setpoint annunciators mode is configured by changing the 1st digit in Code 1. The setpoint annunciators can be configured to operate as follows:

- On when the setpoint activates.
- All annunciators are permanently on and each one only goes off when its setpoint activates.
- All annunciators are always off (See Note 1 on Code 1 diagram on Page 26).
- Setpoint 1 annunciator comes **on** indicating a **rising signal**. Setpoint 2 annunciator comes **on** indicating a **falling signal**.

The example procedure on Page 30 shows how to select the setpoint annunciators to come ON when the setpoints are OFF (not active).

Update Display at Selected Sample Rate

The meter's default display update rate is 0.5 seconds and is set in the 2nd digit of Code 1 as [X0X].

The display can be configured to update at the analog sample rate. The example procedure on Page 30 shows how to configure the display to update at typically 10 samples per second by setting Code 1 to [X2X].

For these settings to take effect, the analog sample rate must be set at [2XX] in Code 2.

See Code 2 – Channel 1 Measurement Task and Sampling Rate on Page 31 for an example.

Manual Loader Mode

The meter can be configured to function exclusively as a manual loader by setting Code 1 to [X1X].

See Analog Output Module Supplement (NZ200) for full details on manual loader mode functions.

Display Functions Mode

The display functions mode is configured by changing the 2nd and 3rd digits in Code 1:

- Selecting [X5X] enters the **Data Source** sub-menu.
- Selecting [X6X] enters the **Display Format** sub-menu.
- Selecting [X7X] enters the **Last Digit Text Character** sub-menu.

Data Source – 2nd Digit [X5X]

The data source for the primary display is configured by selecting **5** in the 2nd digit and the **0** in the 3rd digit:

Note:

[XX1] Second Display is the bargraph display on models DI-50B51, FI-B101D50, and GI-50B101. The [XX1] Second Display and [XX2] Third Display only apply to DI-503 meters with three displays.

The 2nd digit in Code 1 can also be used to configure the data source for the remaining functions in the 3rd digit:

- [X53] = Peak and Valley.
- [X54] = Analog Output 1.
- [X55] = Analog Output 2.
- [X56] = Totalizer 1.
- [X57] = Totalizer 2.

Selecting **5** in the 2nd digit enters a sub-menu and allows you to select the data from one of a number of meter registers as the data source for the displays or functions selected in the 3rd digit.

The example procedure on Page 27 shows how to select the data source for the **primary** display. The three digits are set to [X50].

Display Format – 2nd Digit [X6X]

Selecting **6** in the 2nd digit enters the Display Format sub-menu where the following display format settings can all be configured:

- Last digit rounding.
- Display units (Decimal, octal, or optional 12 or 24-hour clock).
- Decimal point placement.

The example procedure on Page 28 shows how to configure the three display format modes for the 3rd digit selection.

Text Character – 2nd Digit [X7X]

Selecting **7** in the 2nd digit allows you to select one of 54 characters and apply it to the last digit when the meter is in the operational display.

For example, if the meter was measuring a temperature, the display could be configured to display the reading with a C or an F in the last digit for °C or °F.

The example procedure on Page 29 shows how to configure the last digit text character as "C" for centigrade (°C) for the 3rd digit selection.

Note:

After setting any or all the above three modes [X5X], [X6X], [X7X], the Code 1 display must be set back to [X0X] to leave Code 1 and carry on programming.

FIRST DIGIT	SECOND DIGIT	THIRD DIGIT
CODE 1 – DISPLAY CONFIGURATION		
FRONT PANEL ANNUNCIATORS	DISPLAY FUNCTIONS	SELECT DATA SOURCE FOR
0 ON when Setpoints are ON (relay energized) 1 ON when Setpoints are OFF (relay de-energized) 2 Always OFF. See Note 1 3 LED SP1 ON indicates RISING signal trend. LED SP2 ON indicates FALLING signal trend.	0 Normal Display Mode (i.e. operational display shows selected register) updates every 0.5 seconds 1 Manual Loader Mode (Direct Display). See Note* 2 Update at sample rate selected in Code 2 3 - 4 - 5 Select data source as per 3rd digit. See Note 4 6 Select display format as per 3rd digit. See Note 4 7 Select text character as per 3rd digit. See Note 4	0 Primary Display 1 Second Display. See Note 2 2 Third Display. See Note 2 3 Peak/Valley 4 Analog Output 1 5 Analog Output 2 6 Totalizer 1 7 Totalizer 2
		SELECT DISPLAY FORMAT FOR
		0 Result 1 Channel 1 2 Channel 2 3 Channel 3 4 Channel 4 5 Default Display 6 Total 1 7 Total 2
		SELECT TEXT CHARACTER FOR
		0 Result 1 Channel 1 2 Channel 2 3 Channel 3 4 Channel 4 5 Default Display 6 Total 1 7 Total 2

Select Data Source
See diagram below

Select Display Format
See diagram below

Select Last Digit Text Character
See diagram below

Note*:
For the Manual Loader Mode (Direct Display) to work, with Code 1 set to [X54] the data source for the analog output (1 or 2) must be set to [diSP].

Operating range upper and lower limits can be set for the manual loader mode.

The setpoint activation values for setpoint 5 becomes the upper limit and setpoint 6 becomes the lower limit.

When either the direct display or on demand manual loader mode is programmed into the meter, the values for setpoint 5 and setpoint 6 are activated as upper and lower limits.

See Analog Output Supplement for further details.

Note 1:

LED annunciators are always off, except when the meter is in single channel VOLTAGE or CURRENT mode and Code 3 = [X6X], or Code 7 = [X6X] in which case the LEDs indicate which 32-point table has been selected from the rear pins (SP1 = Table 1, SP2 = Table 2, SP3 = Table 3, SP4 = Table 4).

Select Data Source

[P] SourC off

[100] [10] [1] [diSP] [rESL:] [Ch1]

[200] [Ch2]

[244] [Ch3]

[tAR] [VALEY] [PEAK] [tot_2] [tot_1] [Ch4]

Use the [up] [down] buttons to cycle through the Registers Menu and Registers (1 to 244) to select data source for displays, peak and valley, totalizers and analog output (also see page 44).

Display Format Mode

[P] diSP 000 Program the three digits to the required display function mode

FIRST DIGIT	SECOND DIGIT	THIRD DIGIT
LAST DIGIT ROUNDING	DISPLAY UNITS	DECIMAL POINT PLACEMENT
0 No rounding 1 Rounding by 2's 2 Rounding by 5's 3 Rounding by 10's	0 Decimal 1 24-hour clock mode Hours: Minutes: Seconds (6-digit version only) 2 12-hour clock mode (12:30 am is displayed as 12:30A. 12:30 pm is displayed as 12:30P) 3 24-hour clock mode Days: Hours:Minutes (6-digit version only) 4 - 5 - 6 - 7 Octal	0 No decimal point 1 - 2 - 3 X.XXXX 4 X.XXX 5 X.XX 6 X.X 7 Decimal Point set from the rear (X.XXXX to XXXXX) See Note 3. Also See Note 4.

Note:
Selecting 1, 2, or 3 in the 2nd digit of this Mode configures the display of the selected channel (see Step 4) as a clock.

Note 2:
These options are only for use with meters that have more than one display. With bargraph meters the PRIMARY display is the digital display, and the SECONDARY display is the bargraph display.

Note 3:
These functions are only available on selected input modules.

Note 4:
If Code 1's display modes have been entered (second digit set to 5, 6, or 7), the display will cycle between Code 1 and the display functions mode each time the PROGRAM button is pressed. To leave the cycle, the Code 1 digits must be reset to any relevant function between [X00] to [X20]. This takes you into Code 2.

Select Last Digit Text Character

tESL off

Use the [up] button to cycle through the menu, and the [down] button to cycle back.

[up]	[up]	[up]	[up]	[up]	[up]
[down]	[down]	[down]	[down]	[down]	[down]
[up]	6	2	U	E	7
[down]	[down]	[down]	[down]	[down]	[down]
[up]	4	5	2	1	5
[down]	[down]	[down]	[down]	[down]	[down]
[up]	4	3	h	r	4
[down]	[down]	[down]	[down]	[down]	[down]
[up]	3	2	G	a	C
[down]	[down]	[down]	[down]	[down]	[down]
[up]	C	2	E	F	P
[down]	[down]	[down]	[down]	[down]	[down]
[up]	1	1	0	o	4
[down]	[down]	[down]	[down]	[down]	[down]
[up]	0	0	d	n	3
[down]	[down]	[down]	[down]	[down]	[down]
[up]	"	2	9	c	7
[down]	[down]	[down]	[down]	[down]	[down]
[up]	1	0	8	b	L
[down]	[down]	[down]	[down]	[down]	[down]
[up]	0	0	7	A	U
[down]	[down]	[down]	[down]	[down]	[down]

Press the Up or Down button 4 times as the next 4 characters are blank.

Configure Data Source Procedure

The following example procedure describes how to select the source of the data to be displayed for the third digit selection.



Programming Tip

To enter the Main Programming Mode press the [P] and [▲] buttons at the same time. To exit and return to the operational display, press the [P] and [▲] buttons again at the same time.

At the end of any procedure (Step 8 in this procedure) the [P] must be pressed before the [P] and [▲] buttons are pressed, otherwise the meter returns to the operational display without saving the new settings.

Example Procedure:

Configure the Primary Display with the display [diSP] as the data source by setting Code 1 to [X50]. See diagram at the bottom of the page for data source selection options.

Select Data Source

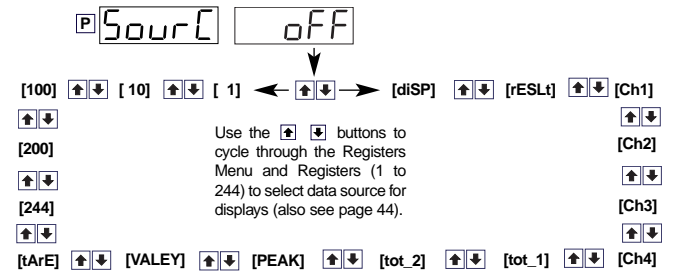

START HERE

CONFIGURE DATA SOURCE

Step 1

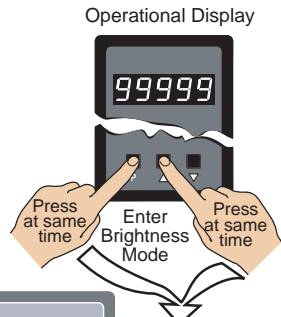

Step 2

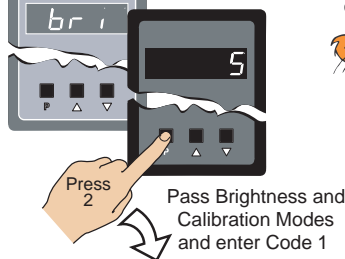

Step 3

Set Code 1 to [X50]:
 1st Digit = X Note relevant
 2nd Digit = 5 Selects data source mode
 3rd Digit = 0 Selects primary display

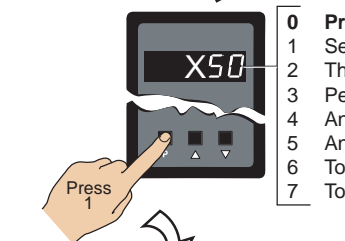

Step 4

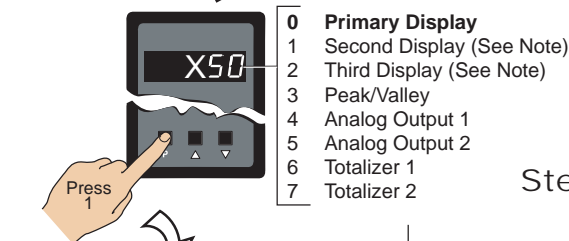

- 0 Primary Display
- 1 Second Display (See Note)
- 2 Third Display (See Note)
- 3 Peak/Valley
- 4 Analog Output 1
- 5 Analog Output 2
- 6 Totalizer 1
- 7 Totalizer 2

Step 5

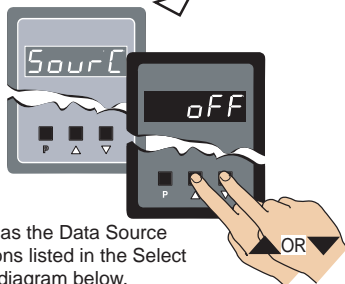

Select [diSP] as the Data Source from the options listed in the Select Data Source diagram below.

From Step 5

Step 6

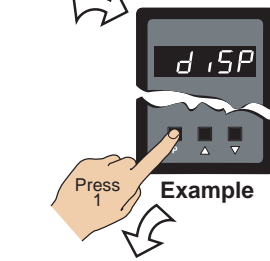

Step 7

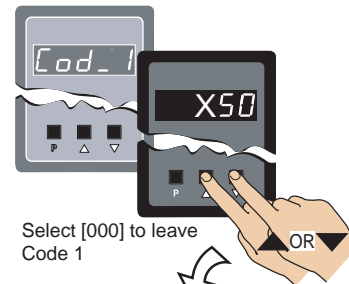

Step 8

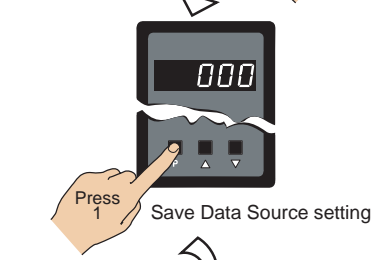

Step 9

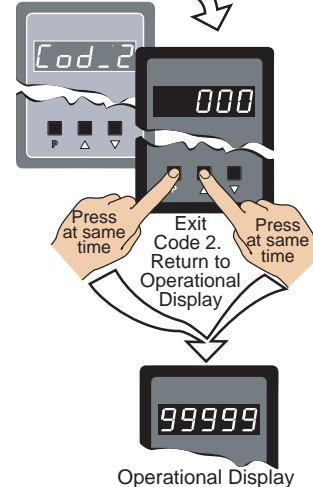

Programming Tip
 Pressing the [▼] button reaches [000] faster.

Programming Tip
 Pressing the [▲] and [▼] buttons at the same time increases the displayed parameter in increments of 100 counts.

Note:

Options 1 and 2 listed for the 3rd digit in Step 3 above are only for use with meters that have more than one display. With bargraph meters the PRIMARY display is the digital display, and the SECONDARY display is the bargraph display.

Configure Display Format Mode Procedure

The following example procedure describes how to configure the display format mode for the 3rd digit selection and covers:

- Last Digit Rounding.
- Display Units.
- Decimal Point Placement.

Example Procedure:

Configure the display format mode for channel 1 with rounding by 2's, decimal display units, and the decimal point placed between display digits 4 and 5 by setting Code 1 to [X61] to enter the Display Format Mode.

Display Format Mode

P **d i s P** **000** Program the three digits to the required display format mode

FIRST DIGIT	SECOND DIGIT	THIRD DIGIT
LAST DIGIT ROUNDING	DISPLAY UNITS	DECIMAL POINT PLACEMENT
0 No rounding	0 Decimal	0 No decimal point
1 Rounding by 2's	1 24-hour clock mode	1 -
2 Rounding by 5's	Hours: Minutes: Seconds (6-digit version only)	2 -
3 Rounding by 10's	2 12-hour clock mode (12:30 am is displayed as 12:30A. 12:30 pm is displayed as 12:30P)	3 X.XXXX
	3 24-hour clock mode	4 X.XXX
	Days: Hours:Minutes (6-digit version only)	5 X.XX
	4 -	6 X.X
	5 -	7 Decimal Point set from the rear (X.XXXX to XXXXX)
	6 -	See Note 3.
	7 Octal	Also See Note 4.

Note:
Selecting 1, 2, or 3 in the 2nd digit of this Mode configures the display of the selected channel (see Step 4) as a clock.

START HERE

CONFIGURE DISPLAY FORMAT

Step 1

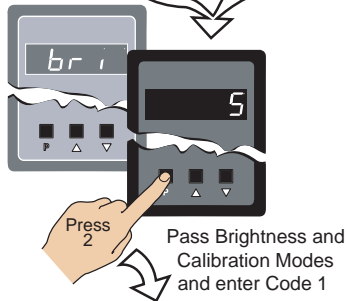
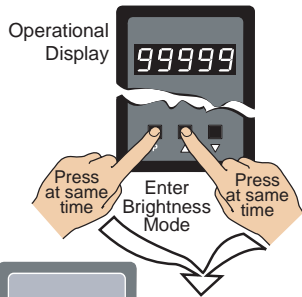

Step 2

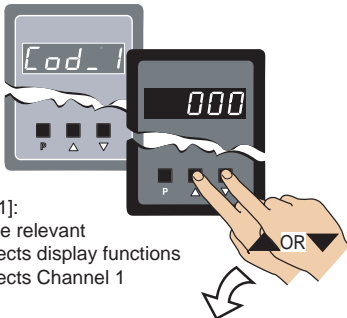

Set Code 1 to [X61]:
1st Digit = X Note relevant
2nd Digit = 6 Selects display functions
3rd Digit = 1 Selects Channel 1

Step 3

Step 4

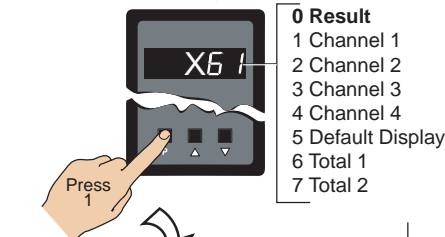

0 Result
1 Channel 1
2 Channel 2
3 Channel 3
4 Channel 4
5 Default Display
6 Total 1
7 Total 2

Step 5

Set Display Format Mode to [106]:

1st Digit = 1 Rounding by 2's
2nd Digit = 0 Decimal display
3rd Digit = 6 Decimal point

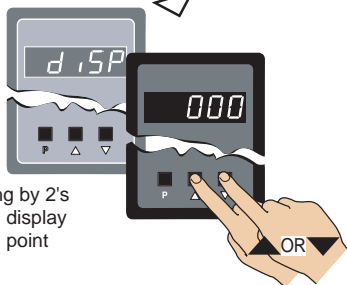

From Step 5

Step 6

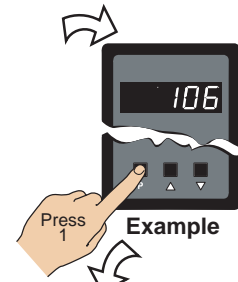

Step 7

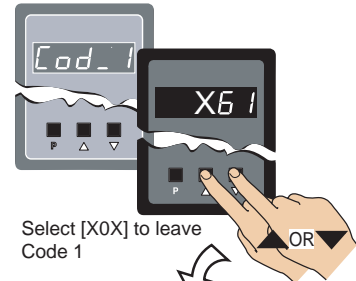

Select [X0X] to leave Code 1

Step 8

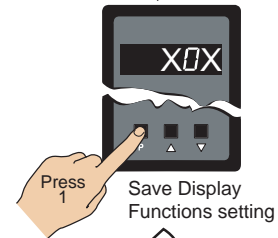

Save Display Functions setting

Step 9

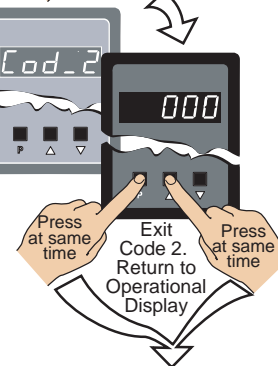

Exit Code 2. Return to Operational Display

Operational Display

Configure Last Digit Text Character Procedure

The following example procedure describes how to select the last digit text character.

Example Procedure:

Configure Channel 1 with C as its last digit text character (for °C) by setting Code 1 to [X71] to enter the Select Last Digit Text Character Mode. See diagram opposite.

START HERE

CONFIGURE LAST DIGIT TEXT CHARACTER

Step 1

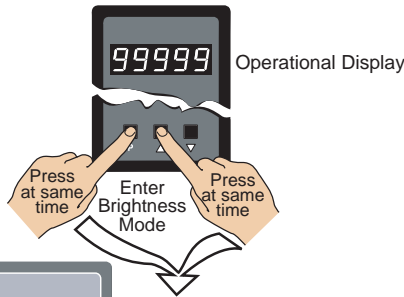

Step 2

Pass Brightness and Calibration Modes and enter Code 1

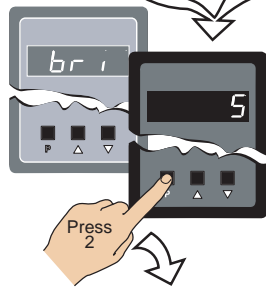

Step 3

Set Code 1 to [X71]:
1st Digit = X Note relevant
2nd Digit = 7 Selects text character mode
3rd Digit = 1 Selects channel 1

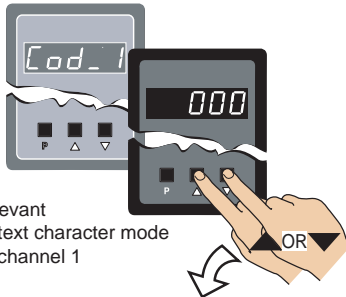

Step 4

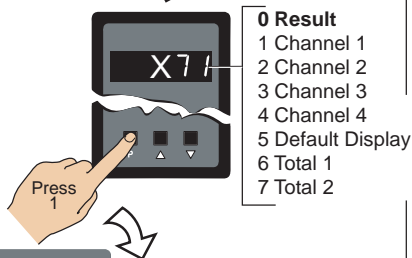

Step 5

Select Text Character [C] from the options listed in the diagram above

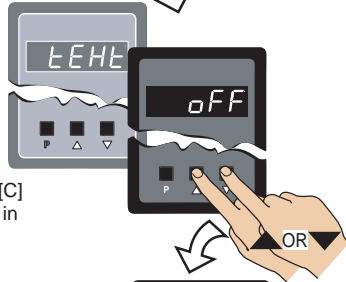

Step 6

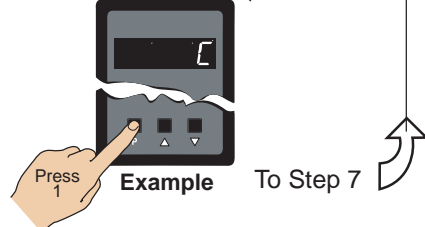

Select Last Digit Text Character

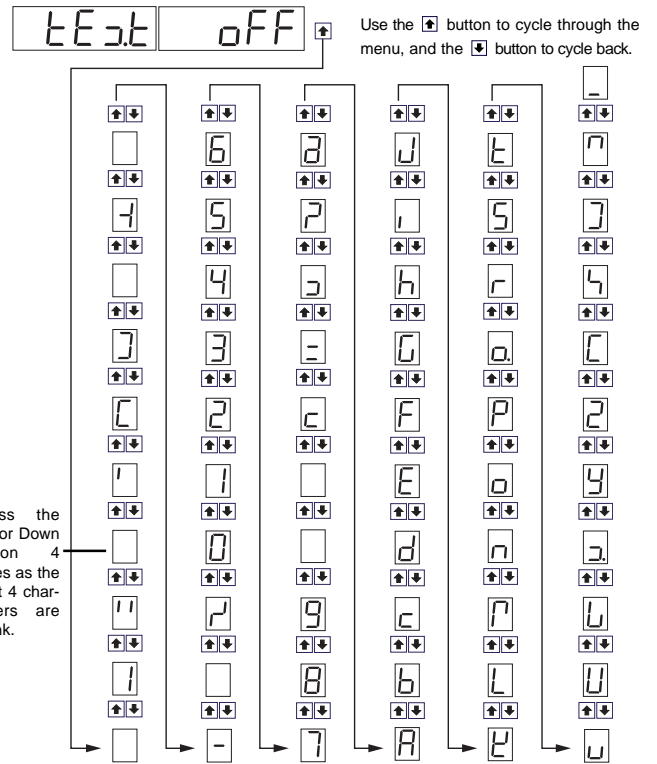

From Step 6

Step 7

Select [X0X] to leave Code 1

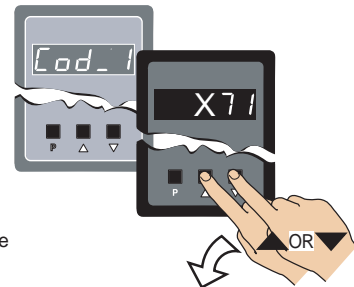

Step 8

Save Last Digit Text Character setting

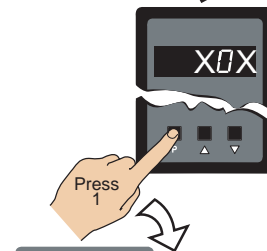

Step 9

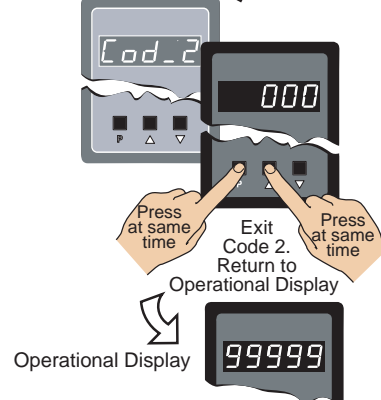

Configure Setpoint Annunciators Procedure

The following example procedure describes how to configure setpoint annunciators.

Example Procedure:

Configure the setpoint annunciators to come ON when the setpoints are OFF (not active) by setting Code 1 to [1XX].

Configure Update at Sample Rate Procedure

The following example procedure describes how to configure the display to update at the sample rate selected in Code 2.

Example Procedure:

Update the display at the sample rate selected in Code 2 by setting Code 1 to [X2X].

START HERE

CONFIGURE SETPOINT ANNUNCIATORS

Step 1



Step 2

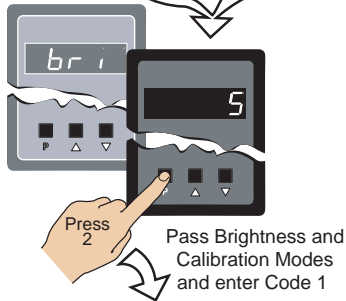

Step 3

Set Code 1 to [1XX]:
 1st Digit = 1 ON when SP OFF
 2nd Digit = X Not relevant
 3rd Digit = X Not relevant

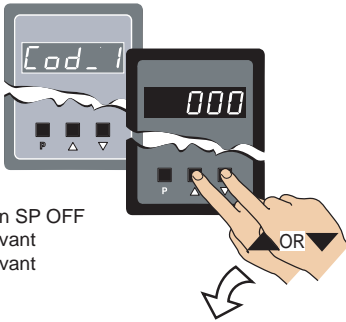

Step 4

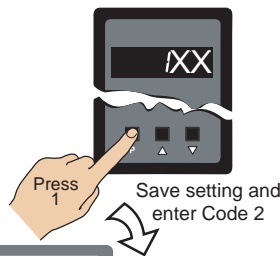

Step 5

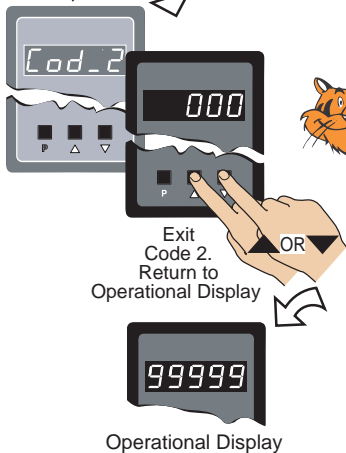

START HERE

CONFIGURE UPDATE AT SAMPLE RATE

Step 1



Step 2

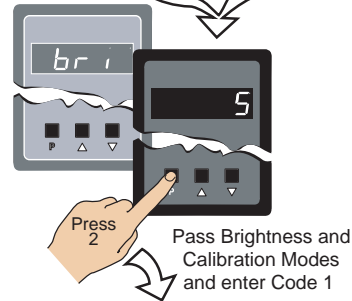

Step 3

Set Code 1 to [X2X]:
 1st Digit = X Not relevant
 2nd Digit = 2 Updates at controlled output rate
 3rd Digit = X Not relevant

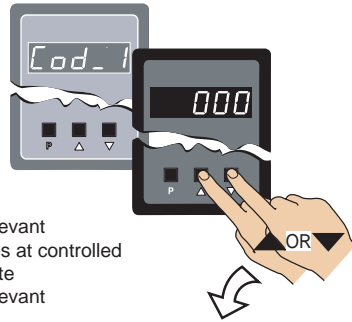

Step 4

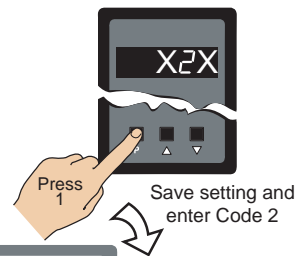

Step 5

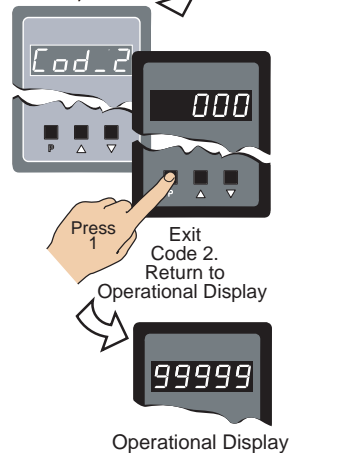

Programming Tip

The *Configuring Setpoint Annunciators* and the *Update at Sample Rate* procedures can be combined so that Code 1 could be set to [12X] (for the above examples) in a single procedure.



[CodE_2] - Channel 1 Measurement Task & Sampling Rate

The Tiger 320 Series DI-50AN6 meter can be configured to measure almost any input signal. The measurement task and sampling rate for Channel 1 (CH1) is configured in the three digits of Code 2. The diagram below lists the available configuration selections in Code 2.

Example Procedure:

Configure CH1 for a voltage input with 10 samples/second (60 Hz rejection) sampling rate and output rate of 0.1 seconds by setting Code 2 to [000].

FIRST DIGIT	SECOND DIGIT	THIRD DIGIT
CODE 2 – CHANNEL 1 MEASUREMENT TASK AND SAMPLING RATE		
ANALOG SAMPLE RATE 0 Sample Rate: Typically 10 samples/second (60 Hz rejection) Output Rate: 0.1 seconds See Example 1 Sample Rate: Typically 10 samples/second (50 Hz rejection) Output Rate: 0.1 seconds See Example 2 Sample Rate: Typically 10 samples/second (60 Hz rejection) Output Rate: 10 millisecs See Example 3 Sample Rate: Typically 10 samples/second (50 Hz rejection) Output Rate: 10 millisecs See Example <i>Note:</i> Output Rate refers to setpoint and macro outputs, and input rates from smart input modules. <i>Note:</i> All above sample rates are quoted for single channel operation. Where more than one channel is available, sample rates are divided by the number of active channels. See Example.	MEASUREMENT TASK 0 Voltage, Current 1 TC (3rd digit selects type of TC) 2 RTD 3-wire (3rd digit selects type of RTD) 3 RTD 2- or 4-wire (3rd digit selects type of RTD) 4 Frequency 5 Period 6 Counter 7 Smart Input Module	FOR VOLTAGE 0 No function 1 Peak detector 2 Pressure with Auto-cal FOR THERMOCOUPLE 0 Type J 1 Type K 2 Type R 3 Type S 4 Type T 5 Type B 6 Type N 7 Select User Defined Table set-up in CAL [24X] FOR RTD TYPE (2-, 3-, 4- WIRE) 0 Resistance 1 RTD 385 2 RTD 392 3 RTD 120 4 Cn 10 FREQUENCY RANGE 0 99.999 Hz range from 0.010 Hz 1 99.999 Hz range from 2.000 Hz 2 999.99 Hz range from 0.01 Hz 3 999.99 Hz range from 2.00 Hz 4 9999.9 Hz range from 0.1 Hz 5 9999.9 kHz range from 2.0 Hz 6 99 kHz range from 1 Hz (1 s gate) 7 655.35 kHz range from 10 Hz (0.1 s gate) PERIOD MEASUREMENT 0 99.999 s 1 9.9999 s 2 999.99 ms 3 99.999 ms COUNTER/RESIDENT TIMER/CLOCK 0 Counter input with 16 bit Pre-scaler 1 Setting of 16-bit Pre-scaler 2 Debounced Counter with Pre-scaler 3 Up/Down Counter with Pre-scaler 4 0.1 sec Timer with Pre-scaler 5 - 6 External 24-hour clock 7 Internal 24-hour clock SMART INPUT MODULE 0 Output Register 1 1 Output Register 2 2 Output Register 3 3 Output Register 4 4 Output Register 5 5 Output Register 6 6 Output Register 7 7 Smart Input Module Setup.
	Example: 10 Samples/Second 1 Channel = 10 samples/second 2 Channels = 5 samples/second 3 Channels = 3.33 samples/second 4 Channels = 2.5 samples/second	

START HERE CONFIGURE CH1 MEASUREMENT TASK & SAMPLING RATE

Step 1

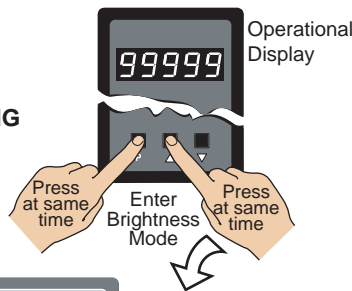

Step 2

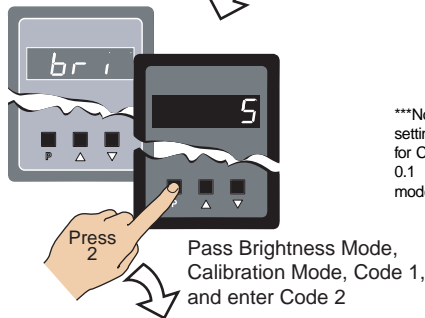

Step 3

Set Code 2 to [000]:
 1st Digit = 0 Selects 10 samples/sec (60 Hz)
 2nd Digit = 0 Selects voltage, current
 3rd Digit = 0 Selects no function

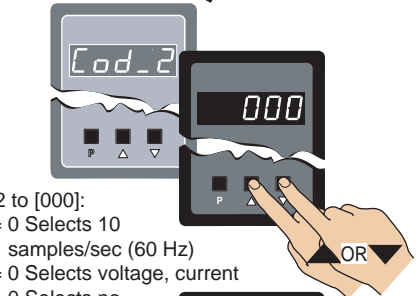

Step 4

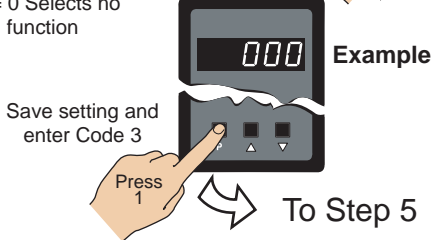

***Note: For the 1 hour setting, the scale factor for CH1 must be set to 0.1 in the calibration mode setting [111].

Use \uparrow \downarrow buttons to set prescale values

X61 Sets Prescaler	
1 =	0.1 second
10 =	1 second
600 =	1 minute
36000 =	1 Hour

Step 5

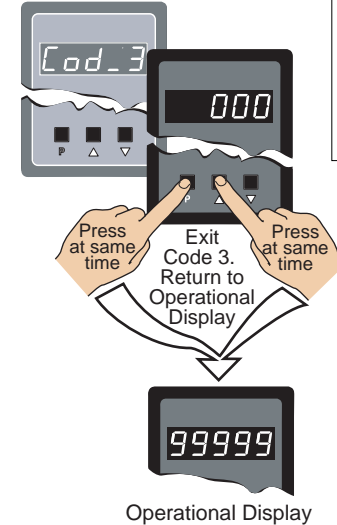

Press \uparrow \downarrow to set the required smart input module code (0 to 377). See I-Series Input Module Guide (Z87) for code details.

[Code_3] - Channel 1 Post Processing & Serial Mode Functions

Post processing functions refer to functions that occur to the input after it has been configured and scaled.

Post processing for Channel 1 (CH1) is configured in the first digit of Code 3. The diagram below lists the available post processing configuration selections in Code 3 (1st digit only).

FIRST DIGIT	SECOND DIGIT	THIRD DIGIT
CODE 3 – CHANNEL 1 FUNCTIONS (POST PROCESSING & SERIAL MODE)		
CH1 POST PROCESSING	32-POINT LINEARIZATION FOR CHANNEL 1	
0 Direct Display of Input (no processing) 1 Square Root of Channel 1 2 Inverse of Channel 1 3 -	0 No Linearization on CH1 1 32-point Linearization on CH1 using Table 1 2 32-point Linearization on CH1 using Table 2. See Note 5 3 32-point Linearization on CH1 using Table 3. See Note 5 4 32-point Linearization on CH1 using Table 4. See Note 5 5 125-point Linearization on CH1 (Tables 1 to 4 cascaded). See Note 5 6 32-point Linearization on CH1 (Tables 1 to 4 selected from the rear pins of selected input modules). The selected table is not available if CH2, CH3, or CH4 is operating in the analog output mode. CH1 must be set to Voltage, Current in Code 2 [X0X]. See Note 5 7 - Note: All linearization tables are set up in the Calibration Mode [24X].	
	SERIAL MODE	
	0 ASCII Mode 1 Modbus Mode 2 Master mode (used to customize print mode protocols via macro) 3 Print Mode 4 Ethernet Mode. See Note 6 5 Devicenet Mode (requires Devicenet hardware module). See Note 6	
	Note 6: These functions are not available on all models and in some cases require additional hardware.	

Note 5:
 If only 4 kB memory installed, functions 2 to 6 are not available in:

- Code 3 second digit.
- Code 4 third digit.
- Code 7 second digit.

START HERE

CONFIGURE CH1 POST PROCESSING FUNCTIONS

Step 1

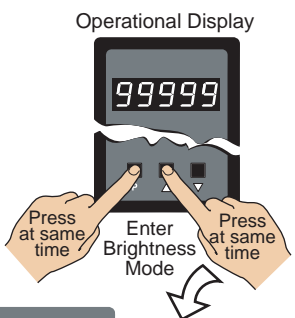

Step 2

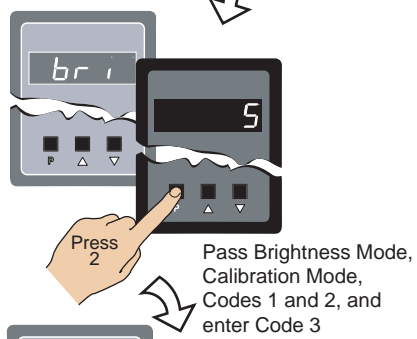

Step 3

Set Code 3 to [100]:
 1st Digit = 1 Square root of CH1
 2nd Digit = 0 No linearization
 3rd Digit = 0 ASCII Mode

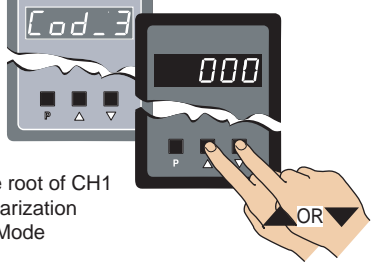

Example Procedure:

Configure the meter to apply square root to the CH1 signal by setting Code 3 to [100].

From Step 3

Step 4

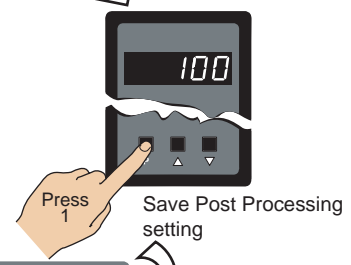

Step 5

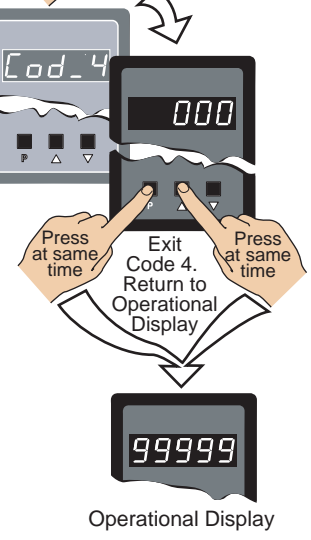

Programming tip

For full details on the Serial Mode, see *Serial Communications Output Module* supplement.

Print Mode – Data Printing Direct to Serial Printer

Print mode data printing is a simple method of capturing data using the meter's print mode. The data can be printed directly to a serial printer from the meter.

The print mode uses the meter's serial communications port to connect to a remote serial printer. The data can be printed with or without a Day: Month: Year or Hours: Minutes: Seconds time stamp.

Time stamp settings are configured in Code 8.

Print Mode – Data Printing Direct to PC

The print mode can also be used to print data to a PC where it is logged in a Windows Terminal program.

The print mode uses the meter's serial communications port to connect to the PC. The data can be logged with or without a Day: Month: Year or Hours: Minutes: Seconds time stamp.

Time stamp settings are configured in Code 8.

[CodE_4] - Channel 2 Measurement Task & Sampling Rate

Code 4 is a single code that combines all the configuration and post processing functions available for Channel 2.

When a **dual input** signal conditioner is installed, the second input signal is processed and displayed on CH2.

Measurement task and 32-point linearization for CH2 is configured in the 1st and 2nd digits of Code 4. The diagram opposite lists the available configuration selections in Code 4.

Example Procedure:

Configure CH2 for a direct voltage input with no linearization by setting Code 4 to [030].

See I-Series Input Modules Guide (Z87) for procedures to set up a dual input module.

FIRST DIGIT	SECOND DIGIT	THIRD DIGIT
CODE 4 – CHANNEL 2 MEASUREMENT TASK AND 32-POINT LINEARIZATION		
MEASUREMENT TASK	FOR VOLTAGE & CURRENT	32-POINT LINEARIZATION FOR CH2
0 Voltage, Current	0 Channel 2 Disabled	0 No user defined Linearization on CH2
1 TC (type as per 2nd digit)	1 Direct (no post processing)	1 32-point Linearization on CH2 using Table 1
2 RTD (type as per 2nd digit)	2 Square Root of Channel 2	2 32-point Linearization on CH2 using Table 2. See Note 5
3 Second Digital Input Channel (type as per 2nd digit)	3 Inverse of Channel 2	3 32-point Linearization on CH2 using Table 3. See Note 5
	4 Output Register 1 (smart module)	4 32-point Linearization on CH2 using Table 4. See Note 5
	5 Output Register 2 (smart module)	5 125-point Linearization on CH2 (Tables 1 to 4 cascaded). See Note 5
	6 Output Register 3 (smart module)	6 –
	7 Output Register 4 (smart module)	7 –
	FOR THERMOCOUPLE	
	0 Type J	
	1 Type K	
	2 Type R	
	3 Type S	
	4 Type T	
	5 Type B	
	6 Type N	
	7 Select user defined table set up in CAL [24X]	
	FOR RTD TYPE (3-WIRE)	
	0 Resistance	
	1 RTD 385	
	2 RTD 392	
	3 RTD 120	
	4 Cn10	
	DIGITAL INPUT	
	0 Frequency - 99.999 Hz range from 0.01 Hz	
	1 Frequency - 999.99 Hz range from 0.01 Hz	
	2 Frequency - 99.999 kHz range from 1 Hz (1 s gate)	
	3 Frequency - 500 kHz range from 10 Hz (0.1 s gate)	
	4 Period - 9.9999 s (100 μs resolution)	
	5 Period - 999.99 ms (10 μs resolution)	
	6 Up/Down Counter with Prescaler	
	7 Set Prescaler	

Note 5:
If only 4 kB memory installed, functions 2 to 6 are not available in:

- Code 3 second digit.
- Code 4 third digit.
- Code 7 second digit.

PRE_5 [] [] []
Use [] [] buttons to set prescale values from 1 to 65535 counts

START HERE

CONFIGURE CH2 MEASUREMENT TASK

Step 1

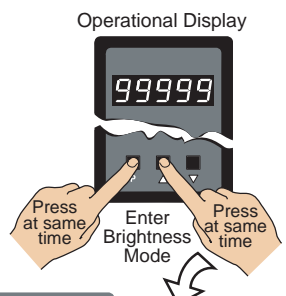

Step 2

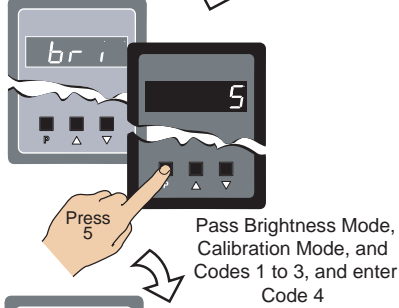

Step 3

Set Code 4 to [030]:
1st Digit = 0 Selects voltage, current
2nd Digit = 1 Selects direct
3rd Digit = 0 Selects no linearization

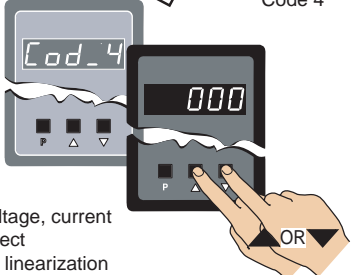

From Step 3

Step 4

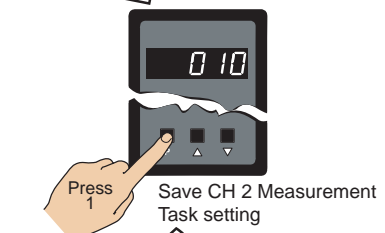

Step 5

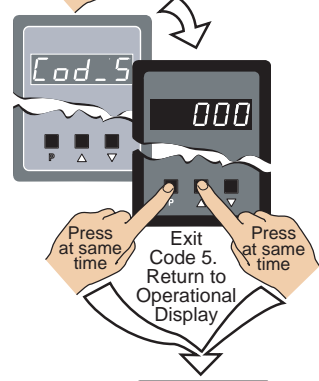

Operational Display

[CodE_5] - Channel 3 Functions

Code 5 is a single code that combines all the configuration and post processing functions available for Channel 3.

When a **triple input** signal conditioner is installed, the third input signal is processed and displayed on CH3.

Post processing and measurement task functions for CH3 are configured in the 1st, 2nd, and 3rd digits of Code 5. The diagram opposite lists the available configuration selections in Code 5.

Example Procedure:

Configure CH3 to display the square root of a voltage input by setting Code 5 to [11X].

See I-Series Input Modules Guide (Z87) for procedures to set up a triple input module.

FIRST DIGIT	SECOND DIGIT	THIRD DIGIT
CODE 5 - CHANNEL 3 FUNCTIONS		
CH3 POST PROCESSING 0 Direct Display of Input (no processing) 1 Square Root of Channel 3 2 Inverse of Channel 3 3 4 kB Meters 32-point Linearization of CH3 using Table 1 3 32 kB Meters 32-point Linearization of CH3 using Table 3 <i>Note:</i> All linearization tables are set up in the Calibration Mode [24X].	MEASUREMENT TASK 0 No Function 1 Voltage / current 2 TC (3rd digit selects type of TC) 3 RTD (3rd digit selects type of RTD) 4 Real Time Clock & Timer (3rd digit selects type) 5 - 6 - 7 Smart Input Module (3rd digit selects register)	FOR THERMOCOUPLE 0 Type J 1 Type K 2 Type R 3 Type S 4 Type T 5 Type B 6 Type N 7 Select user defined linearization table (Table 1) set up in CAL [24X] FOR RTD TYPE (2-, 3-, 4- WIRE) 0 Resistance 1 RTD 385 2 RTD 392 3 RTD 120 4 Cn 10 FOR REAL-TIME CLOCK & TIMER 0 HRS:MIN:SEC 1 HRS:MIN 2 - 3 - 4 1 Second Count UP Timer 5 1 Second Count DOWN Timer 6 - 7 - FOR SMART INPUT MODULE 0 Output Register 1 1 Output Register 2 2 Output Register 3 3 Output Register 4 4 Output Register 5 5 Output Register 6 6 Output Register 7 7 Smart Input Module Register 2 Code Setup

START HERE

CONFIGURE CH3 FUNCTIONS

Step 1

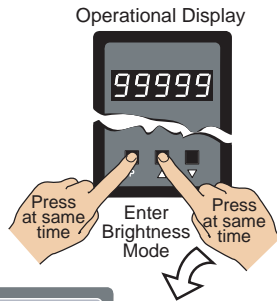

Step 2

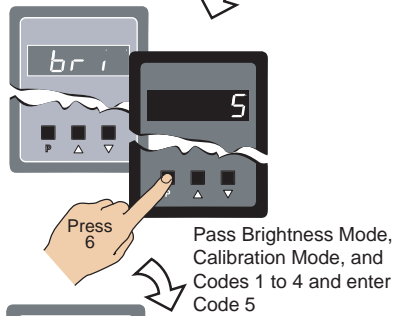

Step 3

Set Code 5 to [11X]:
 1st Digit = 1 Selects square root of CH3
 2nd Digit = 1 Selects voltage, current
 3rd Digit = X Not relevant

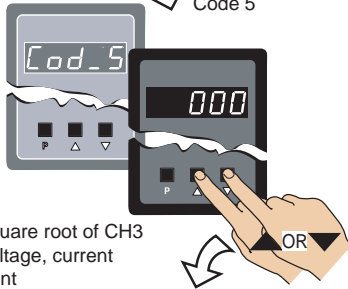

Step 4

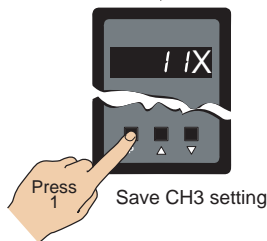

From Step 4

Step 5

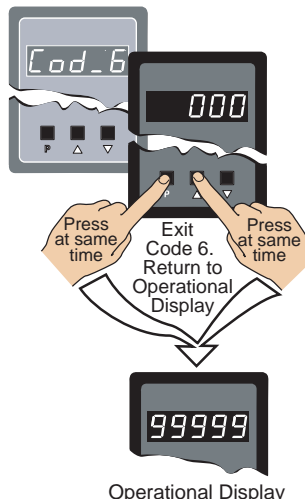

Press **P** **57762** **000**

Use the **↑** **↓** buttons to set the required smart input module code (0 to 377). See *I-Series Input Modules Guide (Z87)* for code details.

[CodE_6] - Channel 4 Functions

Code 6 is a single code that combines all the configuration and post processing functions available for Channel 4.

When a **quad input** signal conditioner is installed, the fourth input signal is processed and displayed on CH4.

Post processing and measurement task functions for CH4 are configured in the 1st, 2nd, and 3rd digits of Code 6. The diagram opposite lists the available configuration selections in Code 6.

Example Procedure:

Configure CH4 as direct display of voltage input by setting Code 6 to [01X].

See I-Series Input Modules Guide (Z87) for procedures to set up a quad input module.

FIRST DIGIT	SECOND DIGIT	THIRD DIGIT																																										
CODE 6 – CHANNEL 4 FUNCTIONS																																												
CH4 POST PROCESSING																																												
0 Direct Display of Input (no processing)	<table border="1"> <thead> <tr> <th>MEASUREMENT TASK</th> <th>FOR THERMOCOUPLE</th> </tr> </thead> <tbody> <tr> <td>0 No Function</td> <td>0 Type J</td> </tr> <tr> <td>1 Voltage / Current</td> <td>1 Type K</td> </tr> <tr> <td>2 TC (3rd digit selects type of TC). See Note 7</td> <td>2 Type R</td> </tr> <tr> <td>3 RTD (3rd digit selects type of RTD). See Note 7</td> <td>3 Type S</td> </tr> <tr> <td>4 Real Time Clock and Timer (3rd digit selects type)</td> <td>4 Type T</td> </tr> <tr> <td>5 -</td> <td>5 Type B</td> </tr> <tr> <td>6 -</td> <td>6 Type N</td> </tr> <tr> <td>7 Smart Input Module (3rd digit selects register)</td> <td>7 Select user defined linearization table (Table 1) set up in CAL [24X]</td> </tr> </tbody> </table> <table border="1"> <thead> <tr> <th>FOR RTD TYPE (2-, 3-, 4-WIRE)</th> </tr> </thead> <tbody> <tr> <td>0 Resistance</td> </tr> <tr> <td>1 RTD 385</td> </tr> <tr> <td>2 RTD 392</td> </tr> <tr> <td>3 RTD 120</td> </tr> <tr> <td>4 Cn 10</td> </tr> </tbody> </table> <table border="1"> <thead> <tr> <th>FOR REAL-TIME CLOCK & TIMER</th> </tr> </thead> <tbody> <tr> <td>0 HRS:MIN:SEC</td> </tr> <tr> <td>1 HRS:MIN</td> </tr> <tr> <td>2 -</td> </tr> <tr> <td>3 -</td> </tr> <tr> <td>4 1 Second Count UP Timer</td> </tr> <tr> <td>5 1 Second Count DOWN Timer</td> </tr> <tr> <td>6 -</td> </tr> <tr> <td>7 -</td> </tr> </tbody> </table> <table border="1"> <thead> <tr> <th>FOR SMART INPUT MODULE</th> </tr> </thead> <tbody> <tr> <td>0 Output Register 1</td> </tr> <tr> <td>1 Output Register 2</td> </tr> <tr> <td>2 Output Register 3</td> </tr> <tr> <td>3 Output Register 4</td> </tr> <tr> <td>4 Output Register 5</td> </tr> <tr> <td>5 Output Register 6</td> </tr> <tr> <td>6 Output Register 7</td> </tr> <tr> <td>7 Smart Input Module Register 3 Code Setup</td> </tr> </tbody> </table>		MEASUREMENT TASK	FOR THERMOCOUPLE	0 No Function	0 Type J	1 Voltage / Current	1 Type K	2 TC (3rd digit selects type of TC). See Note 7	2 Type R	3 RTD (3rd digit selects type of RTD). See Note 7	3 Type S	4 Real Time Clock and Timer (3rd digit selects type)	4 Type T	5 -	5 Type B	6 -	6 Type N	7 Smart Input Module (3rd digit selects register)	7 Select user defined linearization table (Table 1) set up in CAL [24X]	FOR RTD TYPE (2-, 3-, 4-WIRE)	0 Resistance	1 RTD 385	2 RTD 392	3 RTD 120	4 Cn 10	FOR REAL-TIME CLOCK & TIMER	0 HRS:MIN:SEC	1 HRS:MIN	2 -	3 -	4 1 Second Count UP Timer	5 1 Second Count DOWN Timer	6 -	7 -	FOR SMART INPUT MODULE	0 Output Register 1	1 Output Register 2	2 Output Register 3	3 Output Register 4	4 Output Register 5	5 Output Register 6	6 Output Register 7	7 Smart Input Module Register 3 Code Setup
MEASUREMENT TASK			FOR THERMOCOUPLE																																									
0 No Function			0 Type J																																									
1 Voltage / Current			1 Type K																																									
2 TC (3rd digit selects type of TC). See Note 7			2 Type R																																									
3 RTD (3rd digit selects type of RTD). See Note 7			3 Type S																																									
4 Real Time Clock and Timer (3rd digit selects type)			4 Type T																																									
5 -	5 Type B																																											
6 -	6 Type N																																											
7 Smart Input Module (3rd digit selects register)	7 Select user defined linearization table (Table 1) set up in CAL [24X]																																											
FOR RTD TYPE (2-, 3-, 4-WIRE)																																												
0 Resistance																																												
1 RTD 385																																												
2 RTD 392																																												
3 RTD 120																																												
4 Cn 10																																												
FOR REAL-TIME CLOCK & TIMER																																												
0 HRS:MIN:SEC																																												
1 HRS:MIN																																												
2 -																																												
3 -																																												
4 1 Second Count UP Timer																																												
5 1 Second Count DOWN Timer																																												
6 -																																												
7 -																																												
FOR SMART INPUT MODULE																																												
0 Output Register 1																																												
1 Output Register 2																																												
2 Output Register 3																																												
3 Output Register 4																																												
4 Output Register 5																																												
5 Output Register 6																																												
6 Output Register 7																																												
7 Smart Input Module Register 3 Code Setup																																												
1 Square Root of Channel 4																																												
2 Inverse of Channel 4																																												
3 4 kB Meters 32-point Linearization of CH4 using Table 1																																												
4 kB Meters 32-point Linearization of CH4 using Table 4																																												
<i>Note:</i> All linearization tables are set up in the Calibration Mode [24X].																																												

Note 7:
For future development.

START HERE

CONFIGURE CH4 FUNCTIONS

Step 1

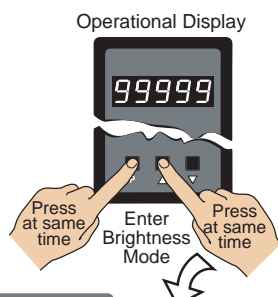

Step 2

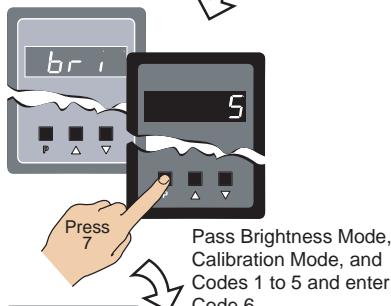

Step 3

Set Code 6 to [01X]:
1st Digit = 0 Selects direct display input
2nd Digit = 1 Selects voltage, current
3rd Digit = X Not relevant

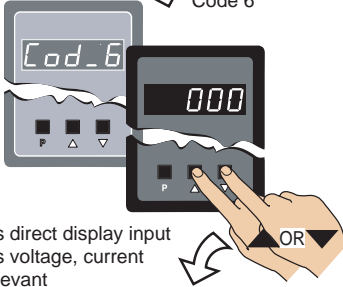

Step 4

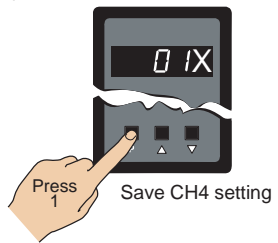

Press **P** **577E3** **000** Use the **▲** **▼** buttons to set the required smart input module code (0 to 377). See *I-Series Input Modules Guide (Z87)* for code details.

From Step 4

Step 5

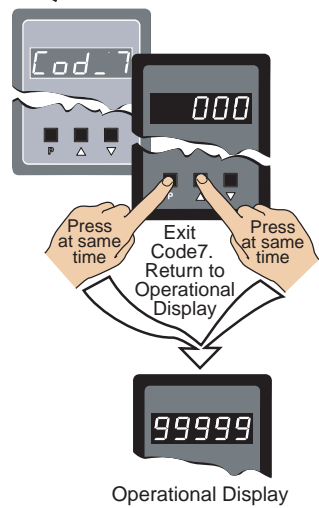

[CodE_7] - Result Processing

The 3rd digit of Code 7 performs various math functions between channel 1 and channel 2 and stores this data in the result register.

The data in the result register can then be further processed by the selections made in the 1st and 2nd digits.

FIRST DIGIT	SECOND DIGIT	THIRD DIGIT
CODE 7 – RESULT PROCESSING		
RESULT PROCESSING	32-POINT LINEARIZATION FOR RESULT	MATHS FUNCTIONS FOR RESULT
0 Direct Display of Result as per processing performed in 2nd or 3rd digit 1 Square Root of Result 2 Inverse of Result 3 -	0 No Linearization on Result 1 32-point Linearization on Result using Table 1 2 32-point Linearization on Result using Table 2. <i>See Note 5</i> 3 32-point Linearization on Result using Table 3. <i>See Note 5</i> 4 32-point Linearization on Result using Table 4. <i>See Note 5</i> 5 125-point Linearization on Result (Tables 1 to 4 cascaded). <i>See Note 5</i> 6 32-point Linearization on Result (Tables 1 to 4 selected from the rear of the meter). The selected table is not available if CH2, CH3, or CH4 is operating in the analog mode. CH1 must be set to Voltage, Current in Code 2 [X0X]. <i>See Note 5</i> 7 -	0 Result Register not Updated 1 pH Meter (CH1 = Tbuff, CH2 = pH) 2 Result = CH1, Setpoint 2 = CH2 3 Result = CH1 + CH2 4 Result = CH1 - CH2 5 Result = (CH1 x 20 000)/CH2 6 Result = CH1 x CH2/10 000 7 Result = CH1

Example Procedure:

Configure Code 7 to add the input of CH1 and CH2 and directly display the result by setting Code 7 to [003].

See I-Series Input Modules Guide (Z87) for procedures to set up a dual, triple, or quad input module.

Linearization Table Notes

A base meter with 4 kB memory installed has a single 32-point programmable linearization table available.

For four 32-point programmable linearization tables to be available, the meter requires at least 32 kB of memory to be installed.

Meters with 4 kB Memory

In base meters with 4 kB memory, set up Table 1 in the Calibration Mode to [24X]. This means that Table 1 is available to be applied to:

- CH1 – Selected in Code 3.
- CH2 – Selected in Code 4.
- CH3 – Selected in Code 5.
- CH4 – Selected in Code 6.

Meters with 32 kB Memory

In base meters with 32 kB or more memory, each of the four tables (Tables 1 to 4) are set up in [24X] of the Calibration Mode by selecting the appropriate table number. This means that the four tables are available for the four channels as follows:

- CH1 – All four tables selected in Code 3.
- CH2 – All four tables selected in Code 4.
- CH3 – Table 3 selected in Code 5.
- CH4 – Table 4 selected in Code 6.

START HERE

CONFIGURE RESULT PROCESSING

Step 1

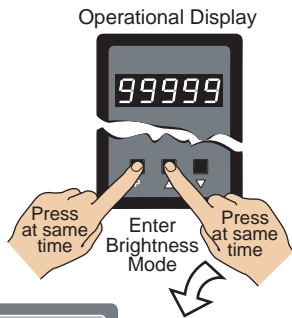

Step 2

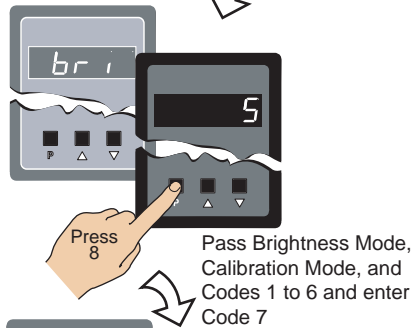

Step 3

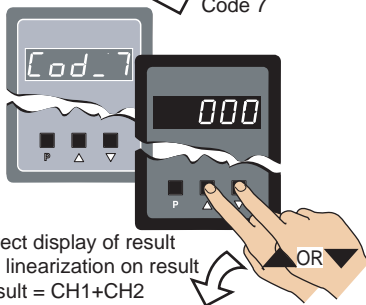

Set Code 7 to [003]:

- 1st Digit = 0 Selects direct display of result
- 2nd Digit = 0 Selects no linearization on result
- 3rd Digit = 3 Selects result = CH1+CH2

Step 4

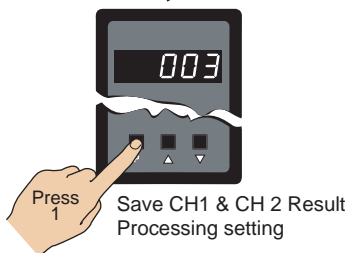

From Step 4

Step 5

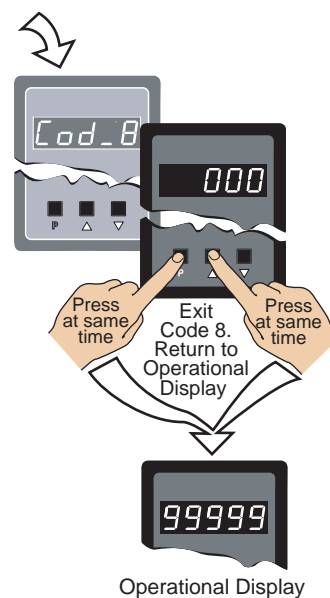

[CodE_8] - Data Logging & Print Mode

Up to 4000 samples can be logged within the meter in the cyclic or linear FIFO mode and saved for later downloading to a PC, using a terminal evaluation program, or printing directly to a serial printer.

Data logging can be triggered (activated) from a setpoint, the program button, or from an external switch. See the 3rd digit in the diagram below.

Data from up to four selectable registers can be logged with one of the following printer or spreadsheet style time and date stamps. All time and date stamps are generated from an optional real-time clock (see the 2nd digit in the diagram below):

- No time stamp.
- Month - Day - Year. Hours:Minutes:Seconds.
- Day - Month - Year. Hours:Minutes:Seconds.
- Hours:Minutes:Seconds.

Printer style time and date stamps have a carriage return and line feed. Spreadsheet style time and date stamps are continuous on a single line.

See *Serial Communications Module Supplement (NZ202)* for full details on the Data Logging and Print Mode Options.

FIRST DIGIT	SECOND DIGIT	THIRD DIGIT
CODE 8 – DATA LOGGING AND PRINT MODE OPTIONS		
DATA LOG BUFFER TYPE	DATE & TIME STAMP OPTIONS	LOG OR PRINT TRIGGER
0 No Data Logging 1 Cyclic Buffer 2 Linear FIFO Buffer. 3 Reset Buffer Number to 0. <i>Note:</i> <i>Setting Code 8 to [3XX] resets the data log buffer to 0. Once reset, Code 8 must be set back to the required data log buffer setting.</i>	0 Printer Format – No time stamp with print/log 1 Printer Format – Time stamp format 1 [Mth-Day-Yr Hrs:Min:Sec] (with <CR><LF>) 2 Printer Format – Time stamp format 2 [Day-Mth-Yr Hrs:Min:Sec] (with <CR><LF>) 3 Printer Format – Time stamp format 3 [Hrs:Min:Sec] (with <CR><LF>) 4 Spreadsheet Format – No time stamp with print/log 5 Spreadsheet Format – Time stamp format 1 [Mth-Day-Yr Hrs:Min:Sec] 6 Spreadsheet Format – Time stamp format 2 [Day-Mth-Yr Hrs:Min:Sec] 7 Spreadsheet Format – Time stamp format 3 [Hrs:Min:Sec] ALL ABOVE ARE REAL-TIME CLOCK OPTIONS	0 No trigger 1 Trigger on Demand from PROGRAM Button 2 Trigger on Demand from F1 Button 3 Trigger on Demand from F2 Button 4 Trigger on Demand from HOLD Pin 5 Trigger on Demand from LOCK Pin 6 - 7 - <i>Note:</i> <i>Log and/or print will only trigger if enabled.</i>

[CodE_9] - Functions for Digital Input Pins

The TEST, HOLD, and LOCK pins are located at the rear of the meter to accommodate external switched digital inputs. When switched to the COMMON pin, they can be programmed in Code 9 to perform remote resetting functions to add to the functionality of the meter.

Note:

CAPTURE, HOLD, and LOCK pins can be a setpoint activation source. See Setpoint Programming mode.

FIRST DIGIT	SECOND DIGIT	THIRD DIGIT
CODE 9 – FUNCTIONS FOR DIGITAL INPUT PINS		
DISPLAY TEST PIN	HOLD PIN	LOCK PIN
0 Display test only 1 Reset Counter Channel 1 and Sub-total at Power-up 2 Reset Counters Channel 1, 2, 3, 4, Total 1, and Total 2 at Power-up 3 Reset Total 1, and Total 2 at Power-up	0 Display Hold 1 Reset Channel 1 2 Reset Total 1 and Total 2 3 Reset Total 2 4 Reset Peak, Valley 5 Reset Tare 6 Set Tare 7 Unlatch (de-energize) all Setpoints	0 Key Lock 1 Reset Channel 1 2 Reset Channel 2 3 Reset Channel 3 4 Reset Channel 4 5 Reset Tare 6 Reset Total 7 Unlatch (de-energize) all Setpoints

Setpoint Programming Mode

All setpoint activation and control settings are selected and configured using the front panel buttons in the **setpoint programming mode**. Or, software configured via the **meter configuration utility program** if the meter is connected to a PC through the serial port. The meter has six software driven setpoints, independently configured to operate within the total span range of the meter and the selected input module.

Relay Output Modules

Five standard relay output module options provide a selection of 20 relay configuration options for DI-50 meters.

Three electromechanical relay output modules support a combination of 5 A Form A and 10 A Form C relays providing 12 configuration options. A solid state relay (SSR) output module supports 400 V, 210 mA DC SSRs and another SSR output module supports 400 V, 140 mA AC / DC SSRs providing a further eight configuration options.

A 22 opto-isolated I/O plug-in module can support six inputs and up to 16 outputs. The standard plug-in module has six inputs and six outputs that can be extended to 16 outputs with a 10 output add-on board.

320 Series Relay Output Module Options

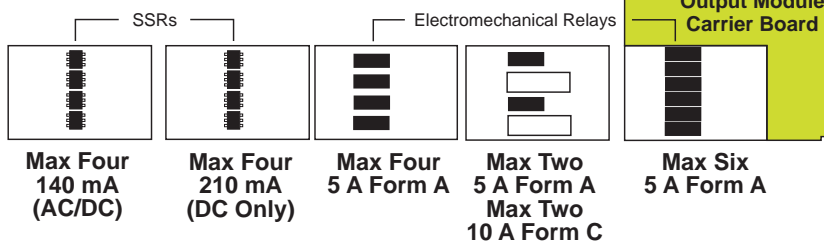

Optional Opto-isolated 22 I/O Plug-in Module

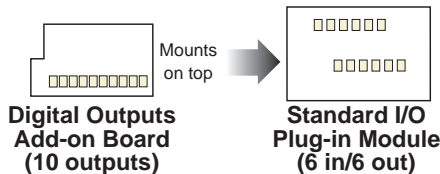

Setpoint Programming Mode

See the *Setpoint Programming Mode Logic Diagram* opposite.

The setpoint programming mode is entered by pressing the meter's **P** and **↓** buttons at the same time.

Setpoint Activation Values

Each setpoint activation value is individually programmed. Setpoint activation values can be set within the total span range of the meter and the selected input module.

Setpoint and Relay Control Settings

See the *Setpoint and Relay Control Settings diagram* on Pages 42 and 43.

The control settings provide access to the following setpoint and relay functions for configuration using the meter's 1st, 2nd, and 3rd digits:

- **1st Digit** – Relay Energize Functions.
- **2nd Digit** – Setpoint Activation Source.
- **3rd Digit** – Setpoint Delay, Timer, and Reset and Trigger Functions.

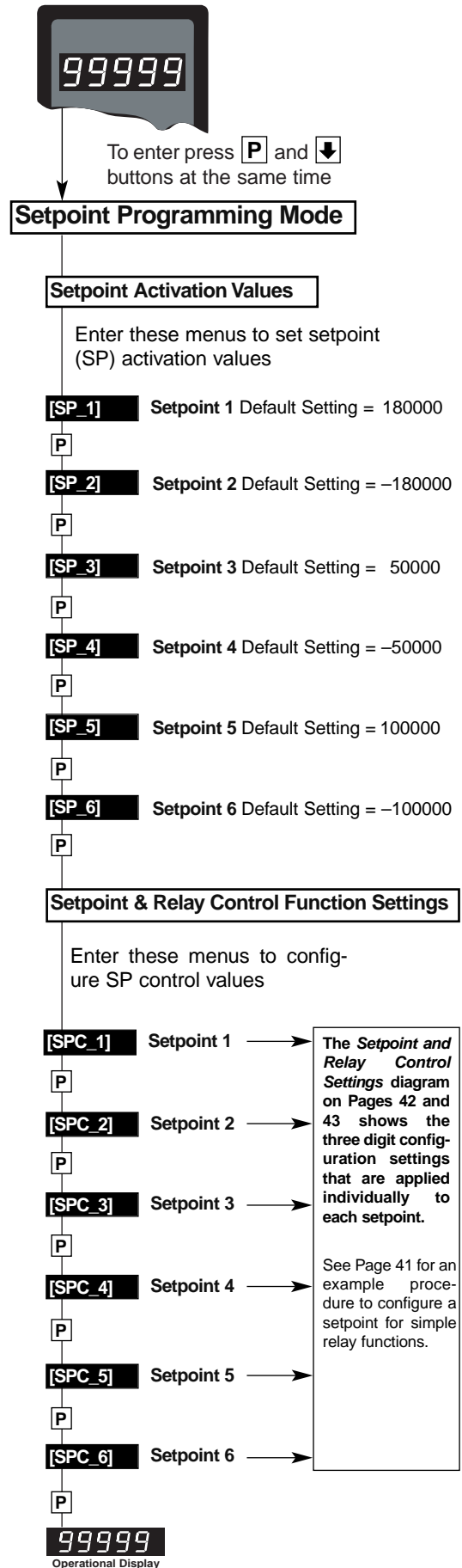

Setpoint Programming Mode Logic Diagram

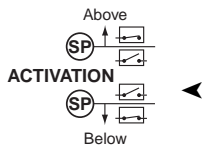

Relay Energize Functions

All setpoints activate at the setpoint value. All relays/setpoints are programmable to energize above or below the setpoint value.

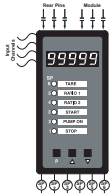

Setpoint Activation Source

Setpoints activate from any input channel, selected meter register, or external switched inputs (digital input pins).

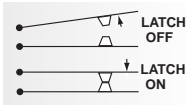

Setpoint Latching

Setpoints can be programmed in relay latching modes.

TRIGGER OPERATES ON:

- MAKE EDGE
- BREAK EDGE
- MAKE & BREAK EDGE
- EVERY SAMPLE PERIOD

RESET SELECTED REGISTER

TRIGGER PRINT

TRIGGER LOG DATA

Setpoint Reset & Trigger

Setpoints can be programmed to reset selected registers, or be manually reset. They can also trigger a data print or a data log.



Setpoint Tracking

Setpoint tracking can be applied to setpoints configured in the hysteresis, deviation, or PID modes.



Display Flashing

Display flashing can be applied to setpoints configured in the hysteresis or deviation modes.

Each setpoint can be programmed to make the display flash on and off while the setpoint is active, and keep it flashing until the setpoint de-activates.

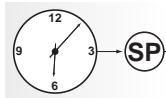

Real-time Clock Option

Any setpoint can be programmed to operate from the real-time clock option.



Data Logging

Any setpoint can be programmed to log data within the meter (up to 4000 samples).

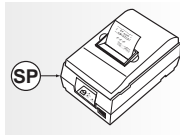

Data Printing to Serial Printer

Any setpoint can be programmed to send data directly to a serial printer.

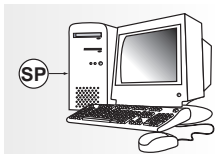

Data Printing to PC

Any setpoint can be programmed to send data directly to a connected PC.



Hysteresis or Deviation

Each relay can operate in a hysteresis or deviation mode.

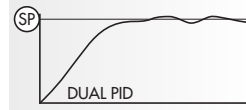

PID Control Settings

The PID (proportional, integral, derivative) control function provides exceptional control stability during control process applica-

tions. PID control is available from the following outputs:

- Setpoint / relay output.
- Analog output.
- Relay and analog output at the same time.

PID control from the setpoint / relay output is available from SP1 and SP2 only.

There are two PID control outputs available via the analog output:

- PID1 – stored in register 50.
- PID2 – stored in register 51.

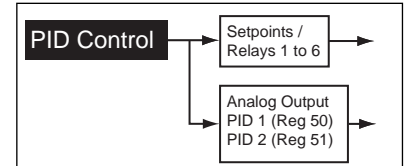

Timer Modes

Each setpoint can be programmed to operate the relay in one of the following seven resident timer modes:

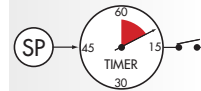

Normal Mode Timer

Single actuation, delay-on-make (DOM) and delay-on-break (DOB).

Normally OFF/Pulsed ON Timers

Repeat ON Mode Timer – multiple actuation, programmable off- and on-time.

Pulse ON Mode Timer – single actuation, programmable DOM and maximum on-time.

1-Shot ON Mode Timer – single actuation, programmable DOM and minimum on-time.

Normally ON/Pulsed OFF Timers

Repeat OFF Mode Timer – multiple actuation, programmable off- and on-time.

Pulse OFF Mode Timer – single actuation, programmable DOB and maximum off-time.

1-Shot OFF Mode Timer – single actuation, programmable DOB and minimum off-time.

Hysteresis or Deviation

Each setpoint can be individually programmed to energize the relay in the hysteresis or deviation mode, with or without initial startup inhibit.

Hysteresis (deadband) is the programmable band above and below the setpoint value that determines when and for how long the relay is energized or de-energized. The setpoint can be programmed to energize the relay above or below the setpoint value.

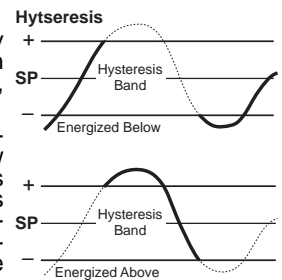

The hysteresis setting can be any value between 0 and 65535 counts. The number of counts selected act both positively and negatively on the setpoint, forming a hysteresis band around the setpoint.

For example, if the setpoint setting is 500 counts and the hysteresis setting is 10 counts, the hysteresis band around the setpoint setting is 20 counts, starting at 490 counts and ending at 510 counts.

Note:

If hysteresis is set with ZERO counts, the relay energizes AT or ABOVE the setpoint value.

Setpoint Programming Mode continued

Deviation (passband) is the programmable band around the setpoint in which the setpoint can be programmed to energize the relay inside or outside the deviation band.

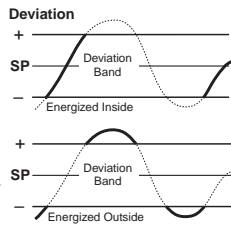

The deviation setting can be any value between 1 and 65535 counts. The number of counts selected act both positively and negatively on the setpoint, forming a deviation band around the setpoint.

For example, if the setpoint setting is 1000 counts and the deviation setting is 35 counts, the deviation band around the setpoint setting is 70 counts starting at 965 counts and ending at 1035 counts.

Initial Start-up Inhibit.

On power-on, start-up inhibit prevents the relay from energizing on the first setpoint activation cycle. Depending on how the meter has been programmed, initial start-up inhibit either functions during a falling input signal, or during a rising input signal.

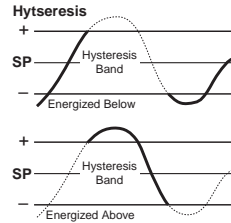

Relay Time Control Modes

The following time control mode settings can cover almost every relay timer application.

All setpoints can be individually programmed to operate a relay in one of the following time control modes above or below the setpoint value.

Normal Mode

This mode individually programs a relay's setpoint with delay-on-make (DOM) and delay-on-break (DOB) settings.

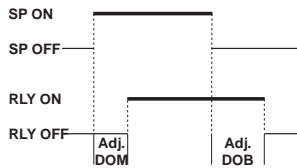

Normally OFF / Pulsed ON Modes

These are delay modes where the relay is normally off and pulses on when the setpoint activates.

Repeat ON Mode

Multiple actuation, programmable on and off time settings.

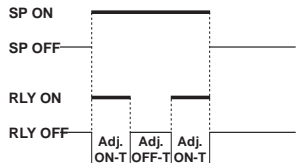

Pulse ON mode (Programmable ON-time)

Single actuation, programmable DOM and on time settings.

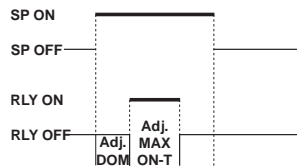

1-Shot ON mode (Programmable Minimum ON-time)

Single actuation, programmable DOM and minimum on time settings.

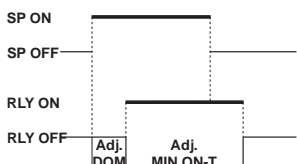

Normally ON / Pulsed OFF Modes

These are delay modes where the relay is normally on and pulses off when the setpoint activates.

1-Shot OFF mode (Programmable Minimum OFF-time)

Single actuation, programmable minimum off time and DOB settings.

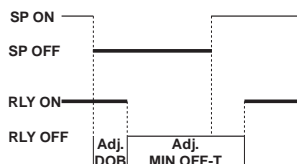

Pulse OFF mode (Programmable OFF-time)

Single actuation, programmable off time and DOB.

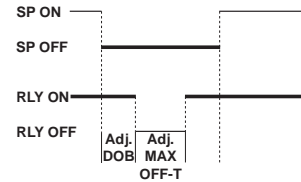

Repeat OFF Mode

Multiple actuation, programmable off and on time settings.

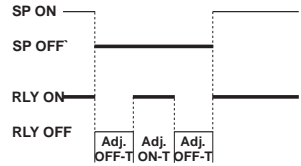

Each setpoint can be individually configured for basic to advanced operations in the following three levels. Each operational level is designed to provide only the required relevant setpoint and relay functions.

The modes at Level 2 and Level 3 can be set to OFF for each individual setpoint, ensuring that no other functions are programmed to influence the setup.

Level 1 Setpoint & Relay Basic Mode

This is an easily programmable mode for users who require the following basic setpoint and relay functions:

First Digit – Relay Energize Functions

Relays programmed to energize above or below the setpoint value.

Second Digit – SP Activation Source

Setpoints programmed to activate from selectable meter registers or one of six external switched inputs.

Third Digit – Setpoint Latching

Relays programmed with latching and manual reset options.

Level 2 Setpoint & Relay Intermediate Mode

Level 2 uses all Level 1 functions and is further extended by the following programmable modes. The functionality of the relay energize functions are extended by allowing the relays to be programmed with or without initial start-up inhibit.

Hysteresis, Deviation & PID Mode

This mode adds extra functionality to the basic mode by providing programmable hysteresis or deviation settings for all setpoints, or PID control from setpoints SP1 and SP2.

Timer Modes

These modes add even more functionality to the basic and intermediate mode by providing each setpoint with a choice of one of seven resident programmable timers.

Level 3 Setpoint & Relay Advanced Mode

Level 3 uses all Level 1 and Level 2 functions combined with reset and trigger functions to provide an extremely powerful advanced mode.

Level 3 enables you to program all setpoints individually for operations normally requiring sophisticated controllers.

Setpoint Programming Mode – Programming Procedures

Example Procedure:

The following procedure describes how to program setpoint 1 (SP1) for the following **Level 1** setpoint and relay functions:

- SP1 to activate from Channel 1 (CH1).
- Relay to energize above or below SP1 value.
- Relay to latch with manual relay reset.

See *Setpoints and Relays Supplement (NZ201)* for procedures to program all setpoint and relay operational levels (Level 1 to Level 3). (See page 3 for more information).

START HERE

CONFIGURE LEVEL 1 SETPOINTa & RELAY FUNCTIONS

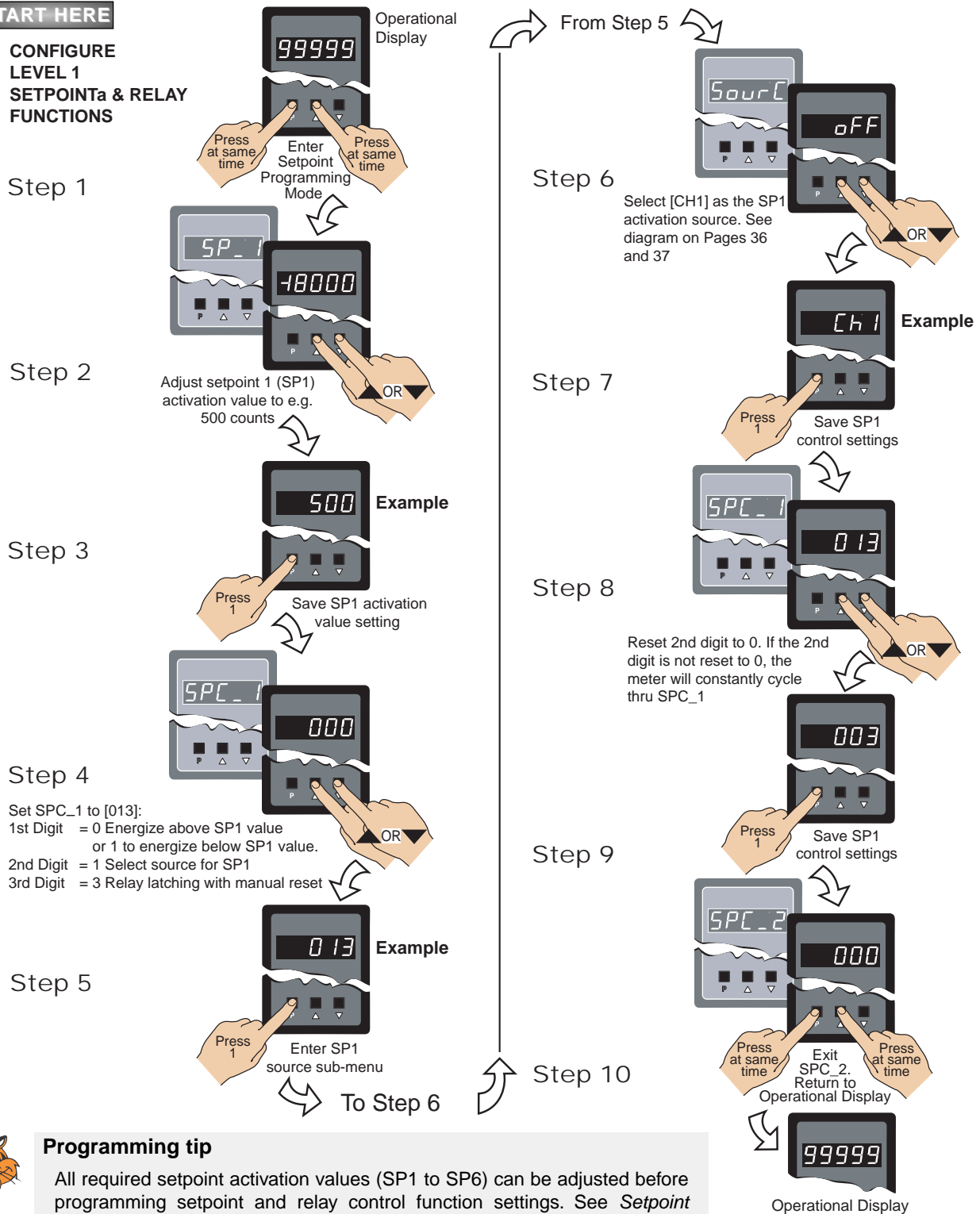

Programming tip

All required setpoint activation values (SP1 to SP6) can be adjusted before programming setpoint and relay control function settings. See *Setpoint Programming Mode Logic Diagram* on Page 42.

Setpoint & Relay Control Settings Diagram

The diagram below and continued on Page 43 shows the 1st, 2nd, and 3rd digit control settings for the setpoints and relays.

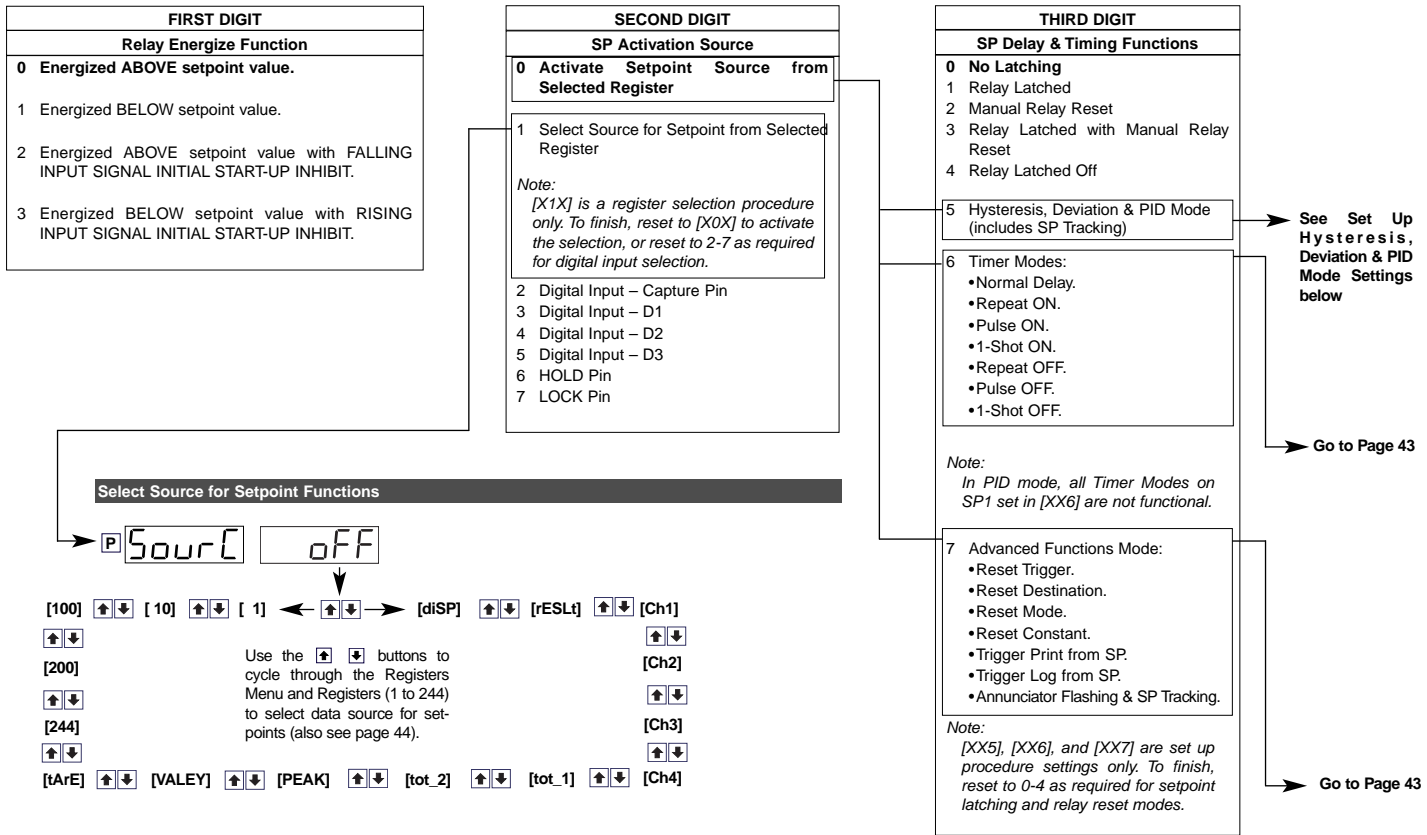

Set Up Hysteresis, Deviation & PID Mode Settings



Programming Tip

If you do not require any of the functions in this mode, ensure it is set to:

[ModE] [off]

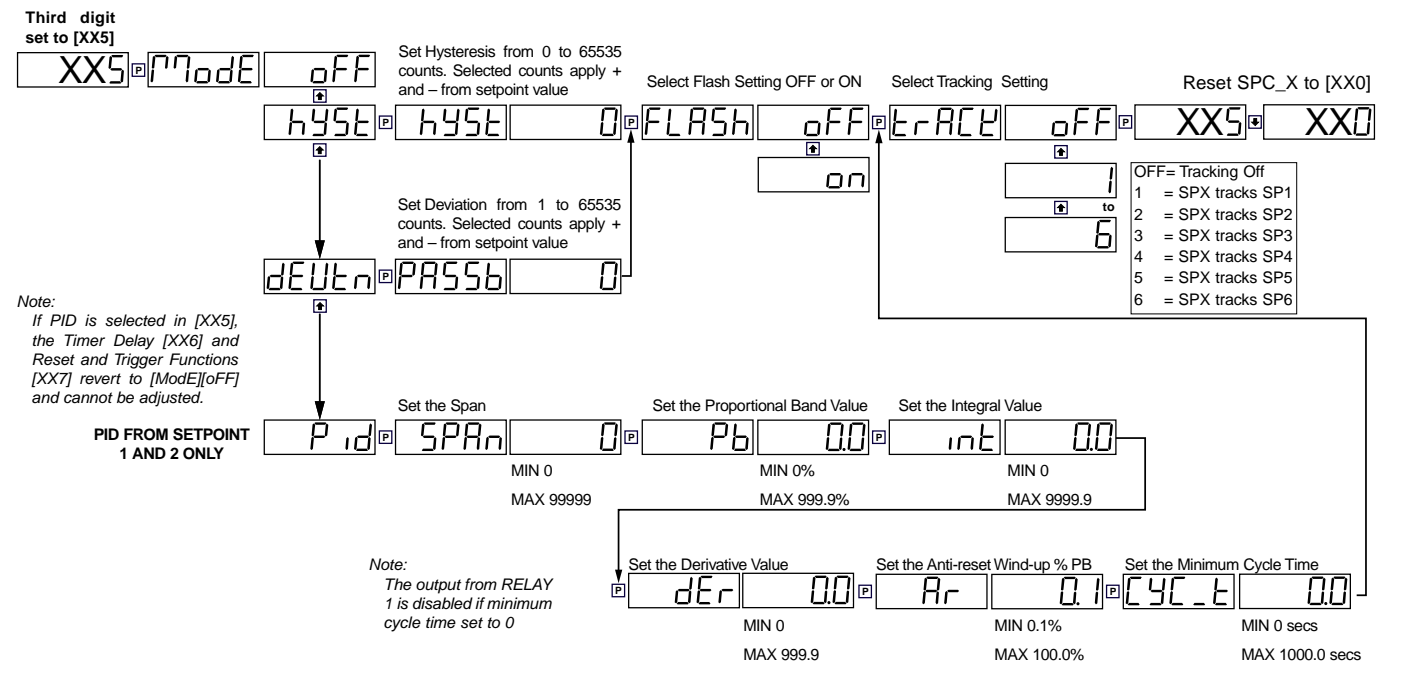

Setpoint Programming Mode continued

Set Up Timer Delay Settings



Programming Tip

If you do not require any of the functions in this mode, ensure it is set to:

timer OFF

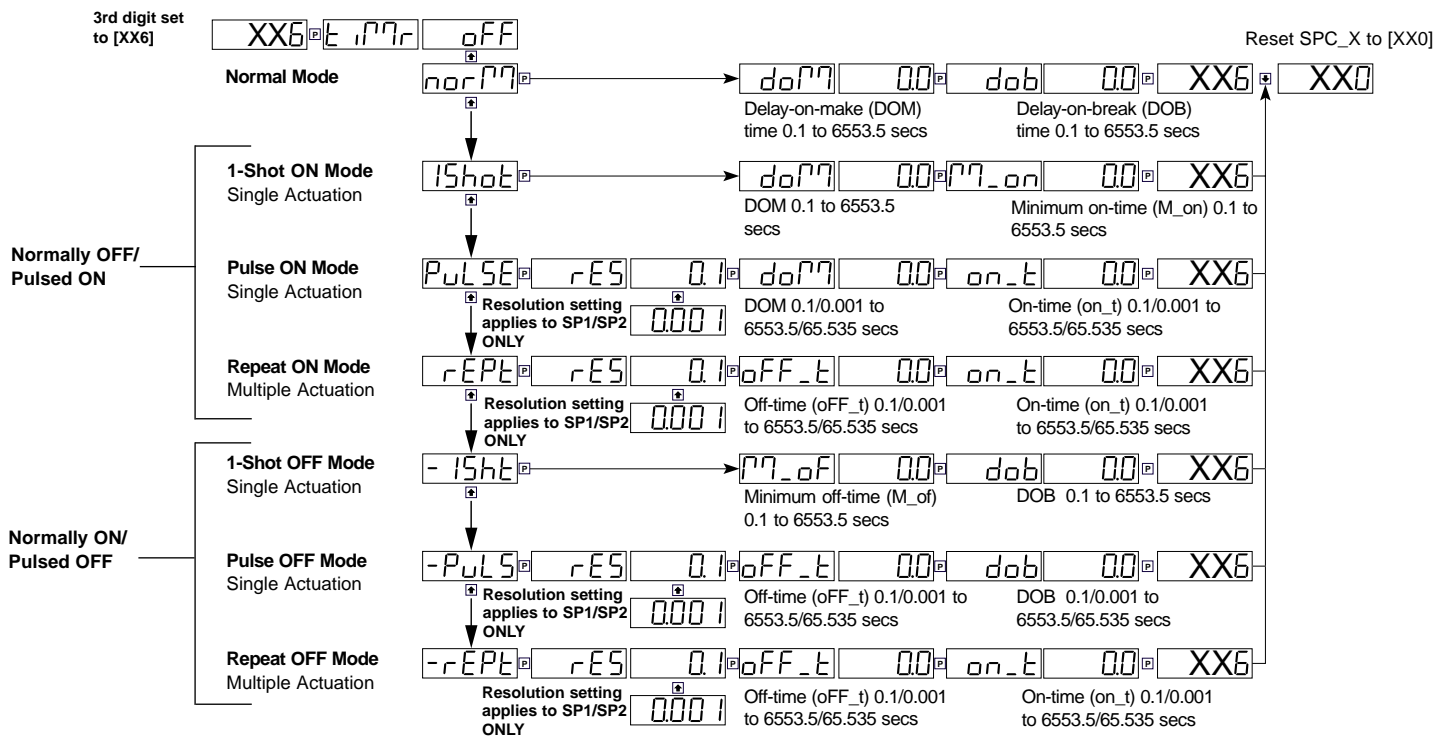

Set Up Register Reset and Setpoint Trigger Functions

Third digit set to [XX7]

Select Trigger Setting

OFF



Select Reset Destination Register

DEST OFF



Selecting [OFF] in the Destination Register Reset Setup takes you to Setpoint Print Trigger Setup

Select Print Triggered by Setpoint

OFF



Select Log Triggered by Setpoint

OFF



Reset SPC_X to [XX0]

→

[brEAK]



[244 to 1]



[diSP]



[both]



[tArE]



[rESLt]



[LEVEL]



[VALEy]



[Ch1]



Use the [↑] and [↓] buttons to cycle through the options

[PEAK]



[Ch2]



[tot_2]



[Ch3]



[tot_1]



[Ch4]



Use the [↑] and [↓] buttons to cycle through the Registers Menu and Registers (1 to 244) to select which destination register is to be reset by a setpoint (also see page 44).

Select Reset Mode

Const



Select Reset Constant

0



Selecting any destination register takes you to Mode Reset



Sets from 0 to -19999



Sets from 0 to 99999



Select [rEG] to access the source parameter to select the number of the Modbus register in the meter to be copied to the reset destination register



[244 to 1]



Use the [↑] and [↓] buttons to cycle through the Registers Menu and Registers (1 to 244) to select which register's contents are to be copied into the destination register by a setpoint (also see page 44).

[Ch1]



[Ch2]



[Ch3]



[Ch4]



Programming Tip

If you do not require any of the functions in this mode, ensure it is set to:

trig OFF

Registers That Can Be Selected By Front Panel Push Button Programming

A Tiger 320 Series meter has 6,144 registers which are provided for use by the operating system and the powerful Custom Macro Programming system (see page 11).

40 Manually Selectable Registers

Using the front panel buttons, there are 40 registers that may be selected for use within the following functions:

- **[CodE_1] - Display Configuration [X50]**. Selection of a register as the data source for displays, peak and valley, totalizers and analog outputs. (See pages 26 & 27)
- **Setpoint Control Settings [X1X]**. Selection of a register as the data source for a setpoint. (See Page 42)
- **Setpoint Control Settings [XX7]**. Selection of a destination register that is to be reset by a setpoint with the contents of a selected source register. (See Page 43)
- **Setpoint Control Settings [XX7]**. Select which register's contents are to be copied into the destination register by a setpoint. (See Page 43)

The 40 registers that can be selected as a data source, a reset source or a reset destination for the functions above are shown in the table on the right.

The table shows, in seven columns, the functions where these registers can be used.

Where a register is more likely to be used in a particular function, a closed circle ● is shown in the column. For those functions where a register is less likely to be used, an open circle ○ is shown.

No register number is shown for the first 11 functions, because these 11 functions are identified in the display menu for direct selection by their code names.

When cycling through the Registers Menu and then Registers 1 to 244, the numerical Register Set will increment through each decade in turn, from 1 to 0, while the button is held down. When [200] is reached, [oFF] or [tArE] will be displayed. To select a specific number set, the button should be released and pressed again each time the left most decade displays the desired number for that decade.

To quickly exit the numerical 1 to 244 Register Set, hold the [↓] button down while cycling through the decades, and release it when [oFF] or [tArE] appears.

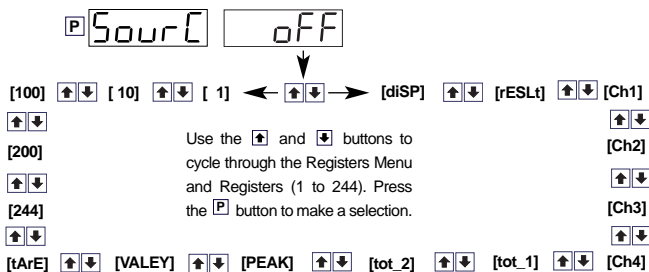

Register Functions	Register Numbers	Data Source for Displays	Data Source for Peak & Valley	Data Source for Analog Outputs 1 & 2	Data Source for Totalizers 1 & 2	Data Source for Setpoints	Reset Source	Reset Dest.
Display [diSP]	-		●	●	●	●		
Result [rESL]	-	●	●	●	●	●	●	●
CH1 [Ch1]	-	●	●	●	●	●	●	●
CH2 [Ch2]	-	●	●	●	●	●	●	●
CH3 [Ch3]	-	●	●	●	●	●	●	●
CH4 [Ch4]	-	●	●	●	●	●	●	●
Total 1 [tot_1]	-	●	●	●		●	●	●
Total 2 [tot_2]	-	●	●	●		●	●	●
Peak [PEAK]	-	○				●	○	●
Valley [VALEY]	-	○				●	○	●
Tare [tArE]	-	○	○	○		●	○	●
PID Output 1	50	○	○	○		○		
PID Output 2	51	○	○	○		○		
Smart Result 1	54	○	○	○				○
Smart Result 2	55	○	○	○				○
Smart Result 3	56	○	○	○				○
Smart Result 4	57	○	○	○				○
Smart Result 5	58							○
Smart Result 6	59							○
Smart Result 7	60							○
Analog Output 1	83	○				○	○	○
Analog Output 2	84	○				○	○	○
Timer 1	95	○				○	○	○
Timer 2	96	○				○	○	○
Smart Reset Offset 1	121							●
Smart Reset Offset 2	122							●
Clock - Seconds	213					○		
Clock - Minutes	214					○		
Clock - Hours	215					○		
Clock - Days	216					○		
Clock - Date	217					○		
Clock - Month	218					○		
Clock - Year	219					○		
Setpoint Latch	221							●
Relay De-energize	222							●
Zero Offset - Result	227					○		
Zero Offset - CH1	228					○		
Zero Offset - CH2	229					○		
Zero Offset - CH3	230					○		
Zero Offset - CH4	231					○		

Resetting and Incrementing Using Setpoints

Setpoints may be used to reset and/or increment registers. In the example shown on the right, 2 liter soft drink bottles are being filled and packed 12 to a case. Using the setpoint reset and increment feature, the number of bottles and the total number of filled cases is easily calculated and displayed. Totalizer 1 counts from 0 to 2, resets, and repeats. CH 2 counts from 0 to 12, resets, and repeats.

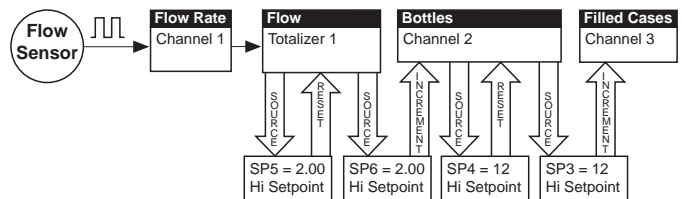

Registers that Should Not be Used

The following registers are contained within the selectable 1 to 244 Register Set, but they should not be selected because they are either reserved for future use, or for use by the operating system only:

15, 38, 47-48, 52-53, 61-64, 123-128, 140-141, 234-244

Any selection of these Registers may cause a malfunction.

USING SETPOINTS TO INCREMENT AND RESET REGISTERS

Functional Diagram

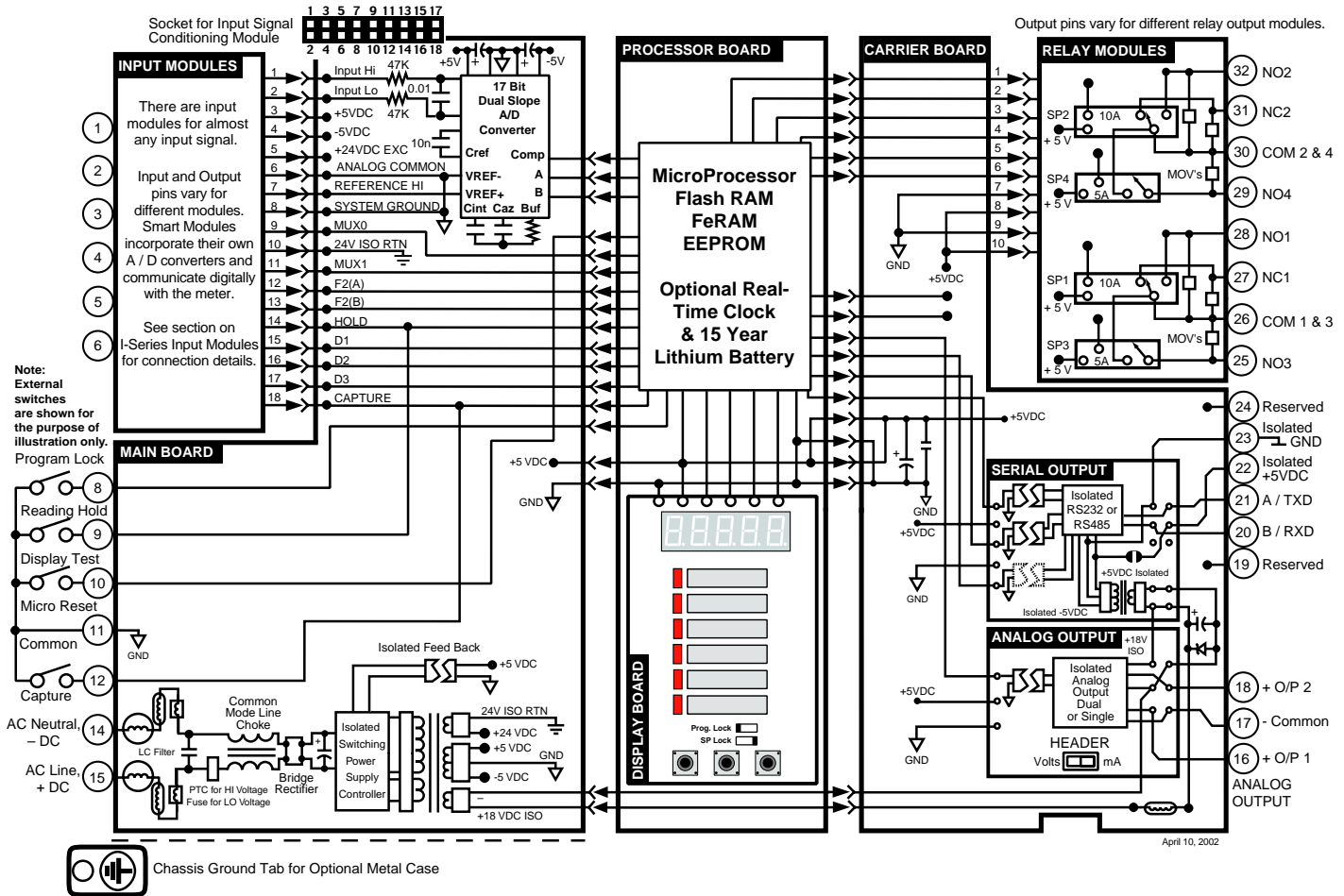

Connector Pinouts

Rear Panel Pinout Diagram

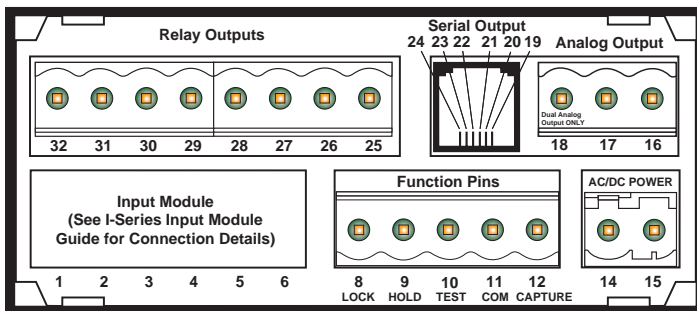

WARNING: AC and DC input signals and power supply voltages can be hazardous. Do Not connect live wires to screw terminal plugs, and do not insert, remove or handle screw terminal plugs with live wires connected.

Input Signal – Pins 1 to 6

See the *I-Series Input Modules Guide (Z87)* for connection details of all input modules. On most single input signal conditioners, usually Pin 1 is the signal high pin (Hi +) and Pin 3 is the signal low pin (Lo -).

Function Pins – Pins 8 to 15

Pin 8 – Program Lock. By connecting the PROGRAM LOCK pin to the COMMON pin (pin 11 on the main PCB), the PROGRAM LOCK pin allows the meter's programmed parameters to be viewed but not changed.

Pin 9 – Hold Reading. By connecting the HOLD READING pin to the COMMON pin (pin 11), the HOLD READING pin allows the

NOTE: The meter uses plug-in type screw terminal connectors for most input and output connections and an RJ-6 phone connector for the optional RS-232 or RS-485 serial outputs.

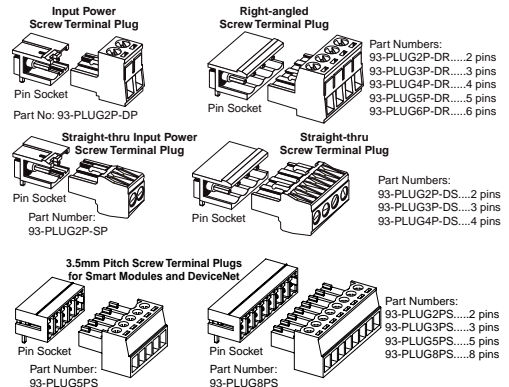

meter's display to be frozen. However, A/D conversions continue and as soon as pin 9 is disconnected from pin 11 the updated reading is instantly displayed.

Pin 10 – Display Test and Reset. The DISPLAY TEST and RESET pin provides a test of the meter's display and resets the microprocessor when the DISPLAY TEST and RESET pin is connected to the COMMON pin (pin 11).

Pin 11 – Common. To activate the HOLD, TEST and RESET, or LOCKOUT pins from the rear of the meter, the respective pins have to be connected to the COMMON pin.

Pins 14/15 – AC/DC Power Input. These are the pins that supply power to the meter. See Power Supply for details of the standard and optional low voltage power supply.

Chassis Ground Tab. Only on versions with metal sheath casing.

Carrier Board Output Pins

Analog Outputs

- Pin 16 – Positive (+) analog output 1.
- Pin 17 – Negative (-) analog output 1 and 2.
- Pin 18 – Positive (+) analog output 2.

Serial Outputs RS-232 or RS-485

Pin No.	RS-232	RS-485
19	Reserved for future use	Reserved for future use
20	RXD. Received Serial	B (Low)
21	TXD. Transmitted Serial	A (High)
22	+5 VDC to power external converters	+5 VDC to power external converters
23	Isolated Ground	Isolated Ground
24	Reserved for future use	Reserved for future use

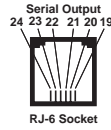

Ethernet – The Ethernet carrier board has the same analog output pins, with 10/100Base-T Ethernet (RJ-45 Socket).

DeviceNet – The DeviceNet carrier board has the same analog pinouts, but with a 3.5mm Pitch Socket. The serial output pins are replaced with DeviceNet pins, as follows:

- Pin 19 - Positive (+) 24V.
- Pin 20 - Can + (positive).
- Pin 21 - N/C.
- Pin 22 - Can - (negative).
- Pin 23 - Negative (-) 24V.

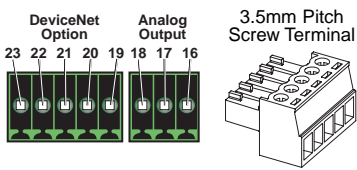

Relay and Logic I/O Modules

Opto Isolated I/O Module for External Breakout Box with 6 Outputs & 6 Inputs, or 16 Outputs & 6 Inputs

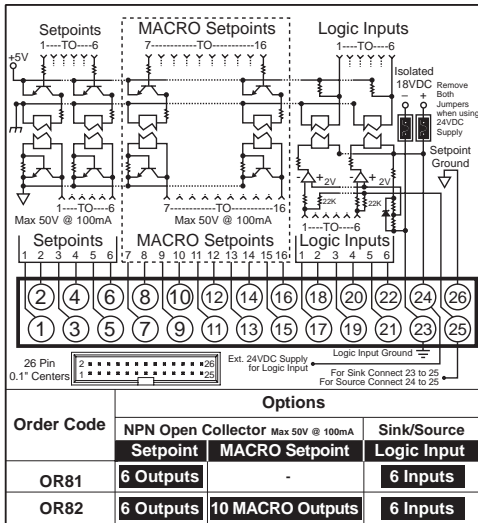

Relay Modules with up to two 5A Form A Relays, and up to two 10A Form C Relays

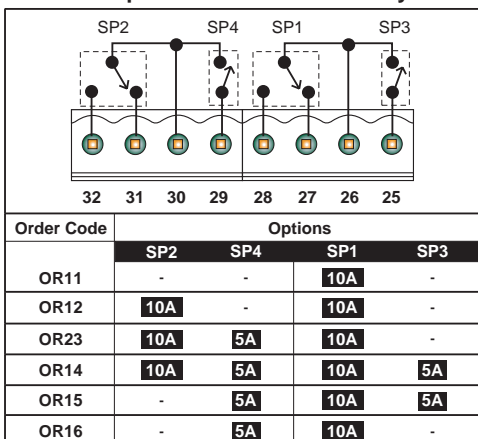

Relay Modules with up to 4 Independent 400V (210mA DC only) or (140mA AC/DC) SSRs

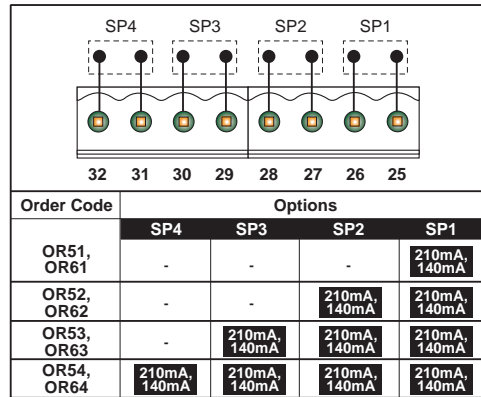

Relay Modules with five or six 5A Form A Relays

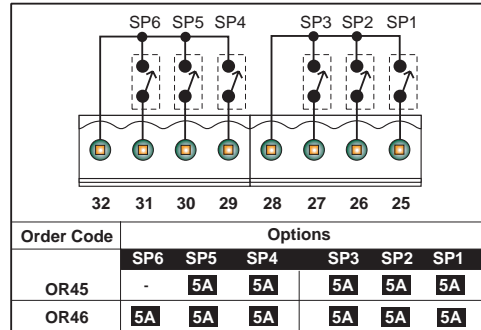

Open Collector / TTL / 5V Output

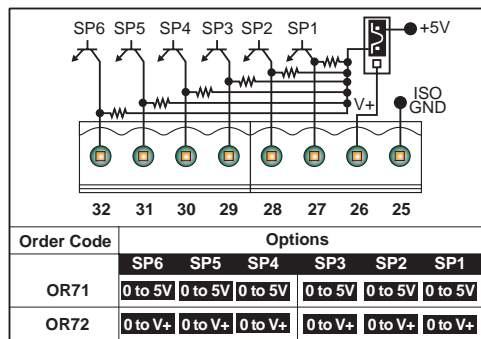

Relay Modules with up to four 5A Form A Relays

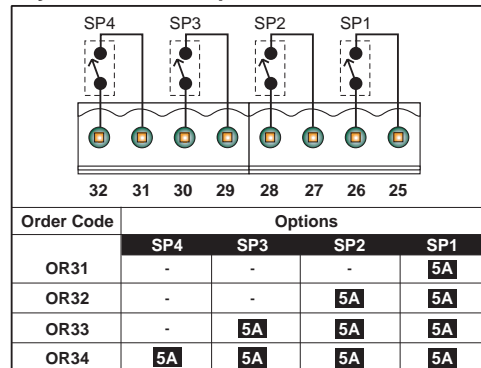

Flash Card Memory Module

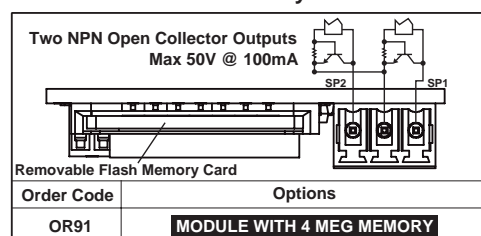

Modular Construction

The Tiger 320 Series of 32-bit Programmable Meter Controllers incorporates, in one instrument, all the different functions required by today's automation and process control applications. This is made possible by modular construction, around standard case sizes, built to American, European, and Japanese standards.

The range comes with a wide variety of display options, including 5 or 6-digit numeric or alphanumeric displays, 6-digit LCD displays, and 51 or 101-segment red, green, or tri-color straight and circular bargraphs.

All meters are housed in one of three DIN case sizes, or the popular 4" ANSI case, and provide the ideal solution for your measurement and process control applications.

Modular construction ensures you don't have to pay for unnecessary hardware. Simply order the input and output options to suit your application.

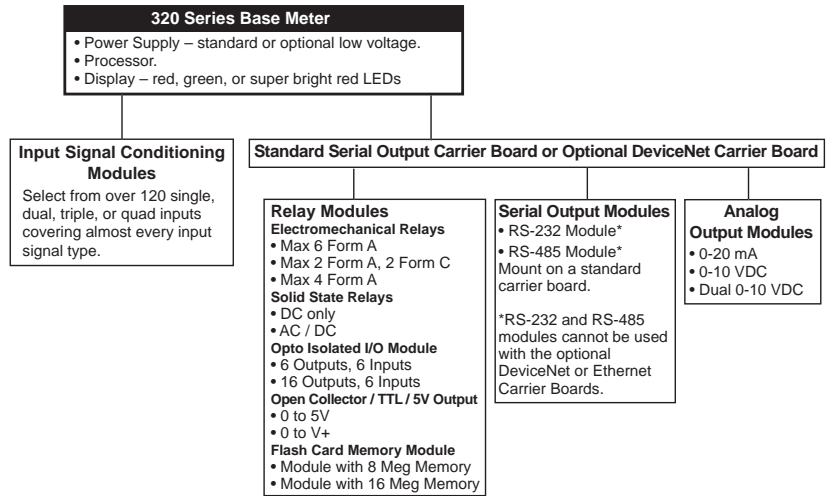

Tiger 320 Series Modular Construction

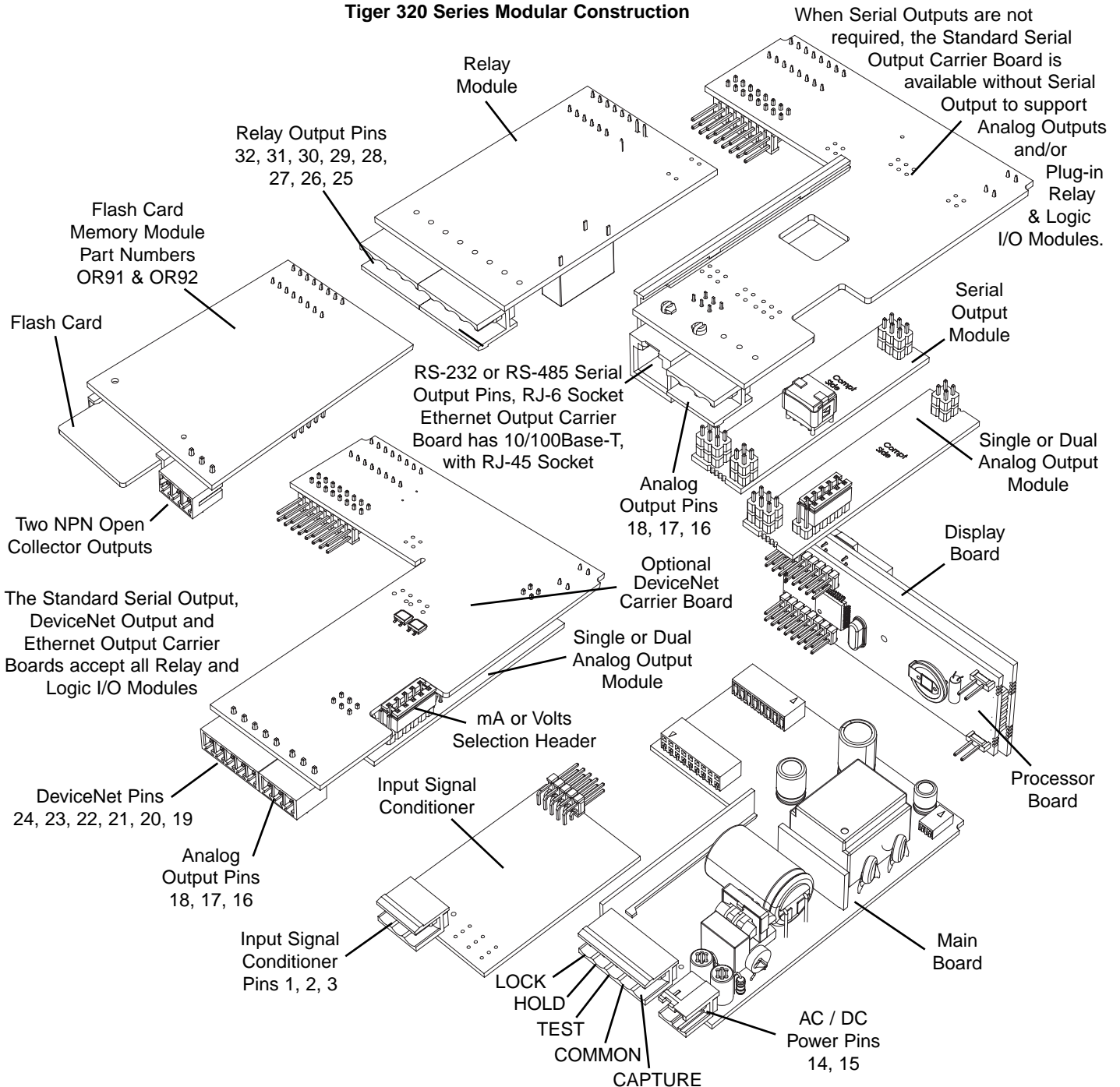

Input Signal Conditioner

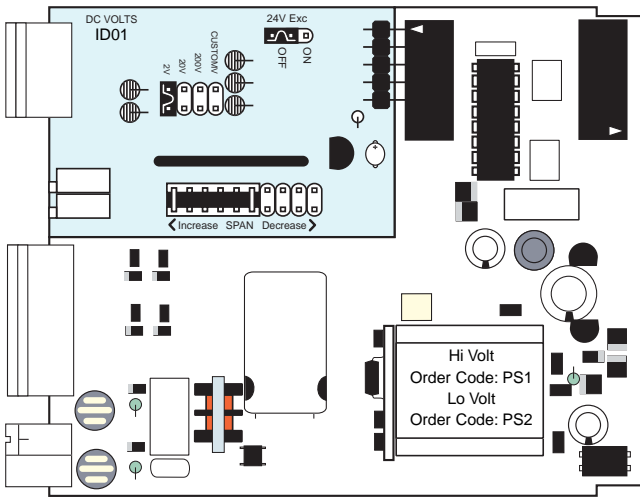

Main PCB*

*Shown with optional Input Signal Conditioning Module (Ordered Separately)

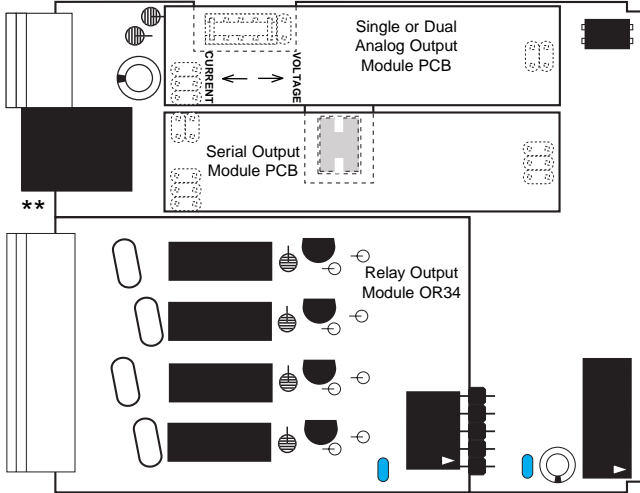
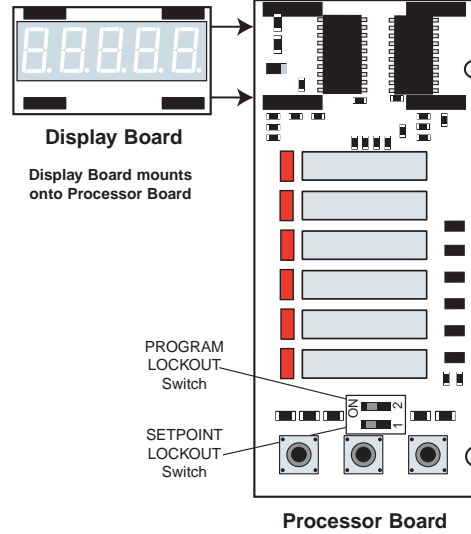

Standard Output Carrier Board*

*Shown with optional Analog Output Module, optional Relay Output Module and a Serial Output Module (RS-232, RS-485 or No Serial Output)

Ethernet Output Carrier Board**

**Is similar to the Standard Output Module Carrier Board, except that the RJ-6 socket is replaced with a 10/100Base-T RJ-45 Socket

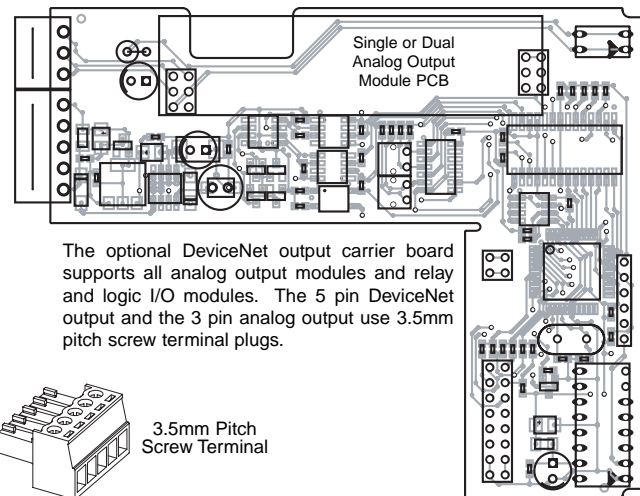

Optional DeviceNet Carrier Board

Analog Output Module PCB

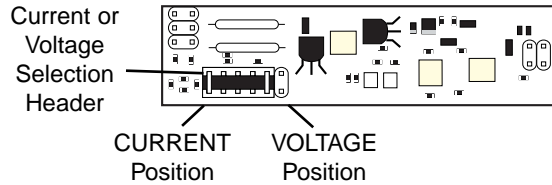

Available in Single (0-4-20mA or 0-10V) or Dual (0-10V & 0-10V)

Standard Serial Output Modules RS-232 or RS-485

Note:
Externally mounted Ethernet compatible communication output modules are available that connect directly to the standard (RS-232 / RS-485) serial module outputs.

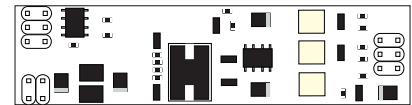

RS-485 Output Module PCB



RS-232 Output Module PCB

Opto Isolated I/O Modules Connect to External DIN Rail Mounting Breakout Box

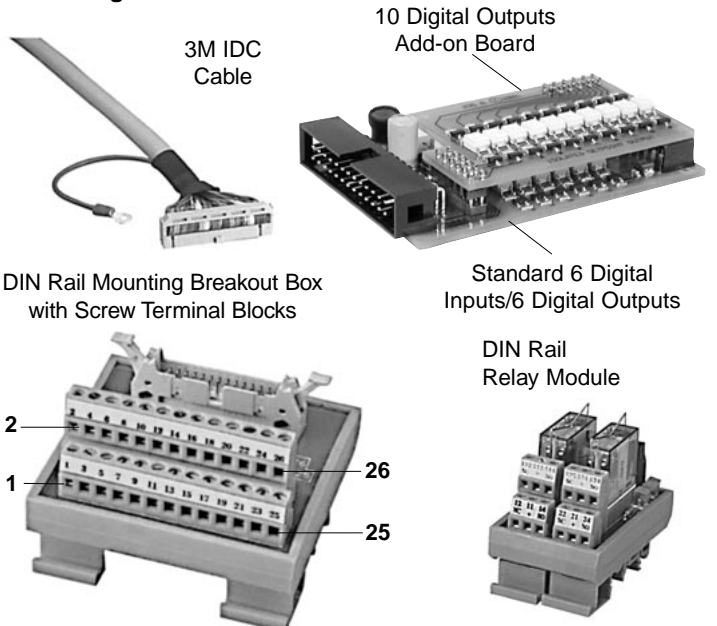

I-Series Input Signal Conditioning Modules continued

Many additional input modules are available and others are constantly being developed. Check with your local distributor or see Texmate's web site at: www.texmate.com for updated information. Pre calibrated **I-Series Input Modules**, that have span or zero potentiometers, **can be interchanged between any I-Series compatible meter**, without recalibration, because all of the analog scaling and reference circuitry is self-contained within the module. Where appropriate, all the standard ranges are designed to be header selectable by the user, and our unique **SPAN ADJUST** Header facilitates **scaling to almost any required engineering unit**. See Input Module Component Glossary for more information.

Unless otherwise specified, we will ship all modules pre calibrated with factory preselected ranges and/or scaling as shown in **BOLD** type. Other pre calibrated standard ranges or custom ranges may be ordered. Factory installed custom scaling and other custom options are also available.

Symbols Indicate Module Compatibility Within Meter Families		
TIGER Family	LEOPARD Family	LYNX Family
TIGER Family	LEOPARD Family	LYNX Family
TIGER Family	LEOPARD Family	LYNX Family
ALL MODELS	SOME MODELS	MODEL SPECIFIC

* TIGER IT03
*A module code shown below a compatibility symbol indicates another module is available, similar in function, which may be more suited for use with that family.

** LYNX FX-B101Q
**Modules which are compatible are listed below the Model Specific Symbol.

Indicates a SMART MODULE. Smart Modules incorporate their own microprocessor and A/D converter. They communicate digitally with the Tiger 320 Operating System. Some also have their own SSR outputs.

IA01: AC Volts Scaled RMS, 200/**600V** AC

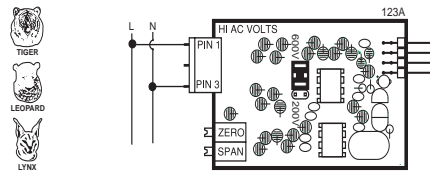

IA08: AC Milliamps True RMS, 2/**20/200mA** AC

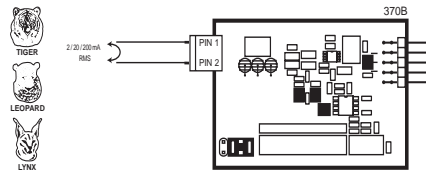

ID02: DC Millivolts, 20/50/**100/200mV** DC w/24V DC Exc

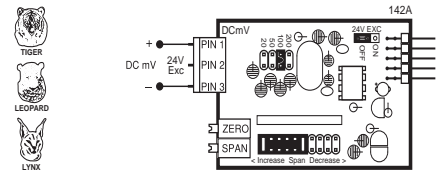

IA02: AC Volts Scaled RMS, 200mV/**2V/20V** AC

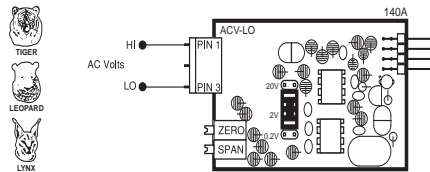

IA09: AC Amps True RMS, **1 Amp** AC
IA11: AC Amps True RMS, **5 Amp** AC

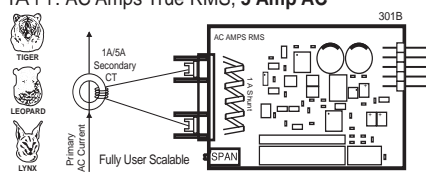

ID03: DC Milliamps, 2/**20/200mA** DC w/24V DC Exc

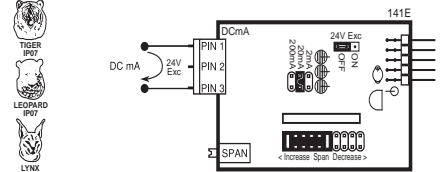

IA03: AC Milliamps Scaled RMS, 2/**20/200mA** AC

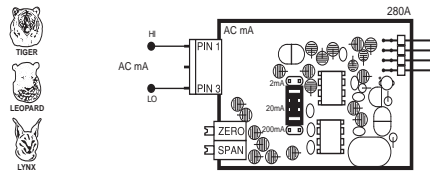

IA10: AC Millivolts, Scaled RMS, **100mV** AC

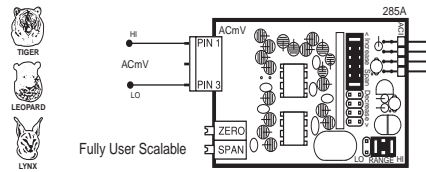

ID04: DC Amps, **5A** DC
ID09: DC Amps, **1A** DC

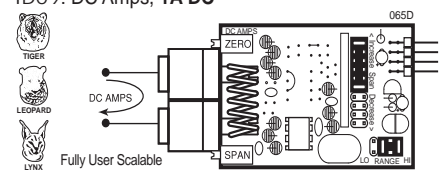

IA04: AC Amps Scaled RMS, **1 Amp** AC

IA05: AC Amps Scaled RMS, **5 Amp** AC

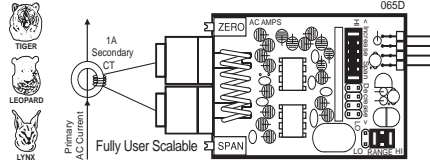

IA12: AC Millivolt RMS Sigma Delta

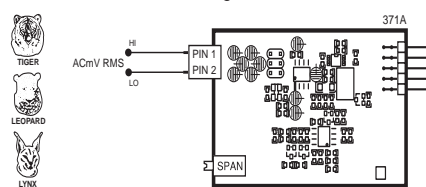

ID05: DC Volts 2/20/200/Custom V DC with Offset and 24V Exc.

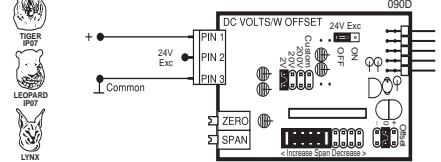

IA06: AC Volts True RMS, **300/600V** AC

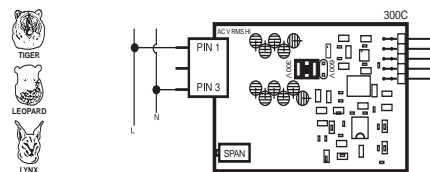

IC02: Quadrature Counter
IC03: Quadrature Counter w/dual SSRs

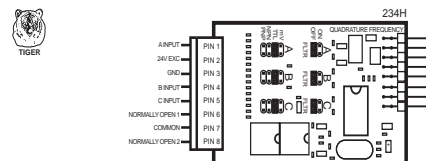

ID06: DC Volts 2/20/200/Custom V DC with External Decimal Select

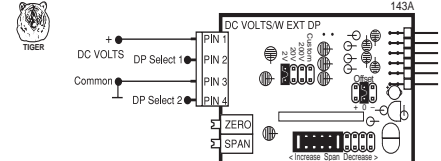

IA07: AC Volts True RMS, 200mV/**2V/20V** AC

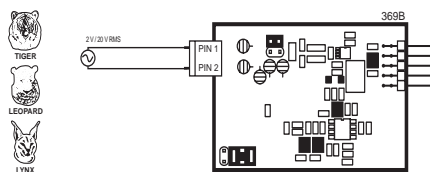

ID01: DC Volts, 2/20/200V/Custom w/24V DC Exc

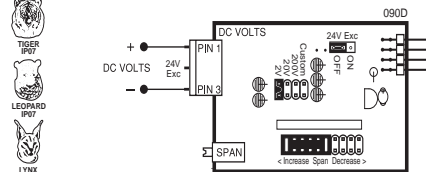

ID07: DC Milliamps, 2/**20/200mA** DC with Offset and 24V Exc

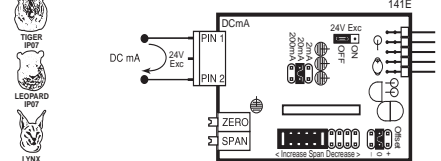

I-Series Input Signal Conditioning Modules continued

ID08: DC Volts, 2/20/200/Custom V DC with External LIN Table Select

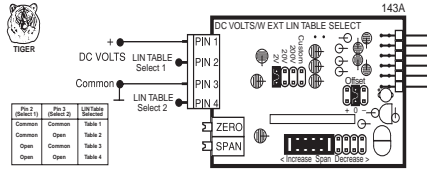

IDP1: Dual Process Loop, 4-20mA

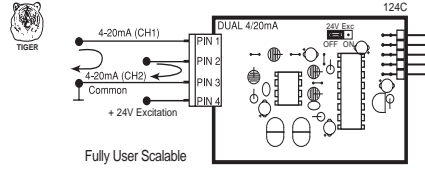

IDT2: Dual RTD Input, 2/3-wire, 100 Pt

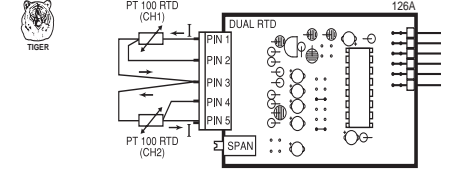

IDC1: Dual UP/DOWN Counter

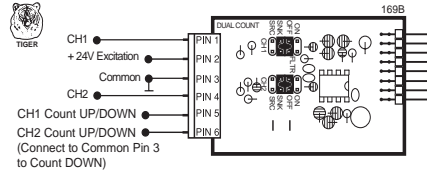

IDP2: Dual Input, 3-wire RTD and 4-20mA

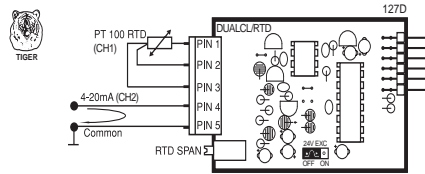

IDT3: Dual Input, 3-wire RTD and DCV

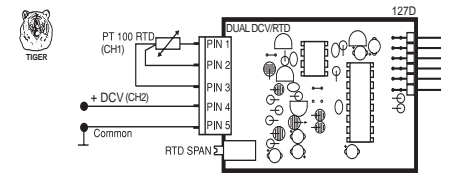

**IDD1: Dual DC Volts, 2V DC
IDD2: Dual DC Millivolts, 50mV DC**

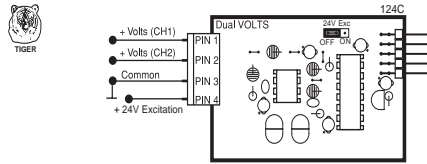

IDP3: Dual Input- Thermocouple (J/K/R/S/T/B/N) and 4 to 20mA

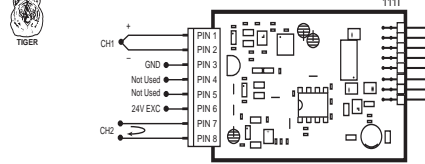

**IDT4: Dual Input- Thermocouple (J/K/R/S/T/B/N) and 2VDC Input
IDT5: Dual Input- Thermocouple (J/K/R/S/T/B/N) and 50mV Input**

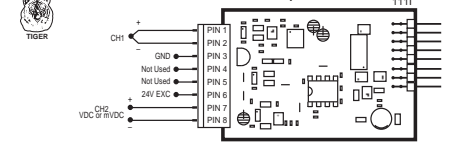

IDD3: Dual DC Milliamps, 2mA DC

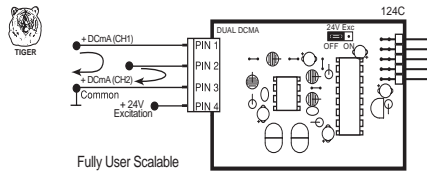

IDR1: Dual Resistance Input, 0.2/2/20K

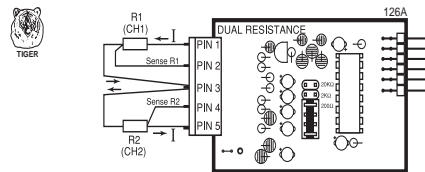

IDT6: Dual Input - Thermocouple and Load Cell

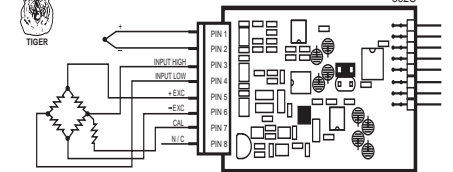

IDD4: Dual Input, DCV and DCmV 2V/50mV DC

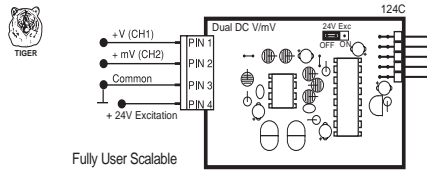

IDS1: Dual Strain Gage Input, 4 wire 2mV/V, 20mV/V

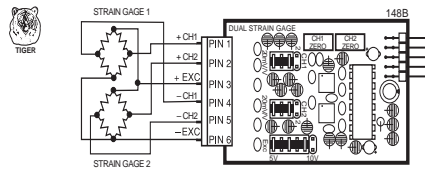

IF06: Line Frequency

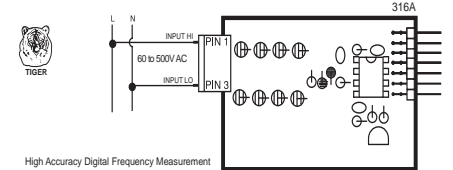

IDD5: Dual Input, DCV and 4 to 20mA 2V/4 to 20mA DC

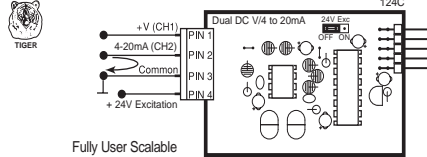

IDS2: Dual Pressure Input, 4 wire 2mV/V, 20mV/V

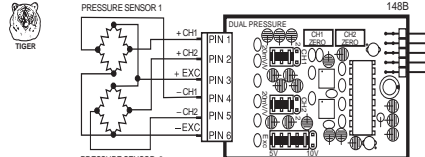

IF10: Univ. Freq. / RPM / UP DOWN Counter

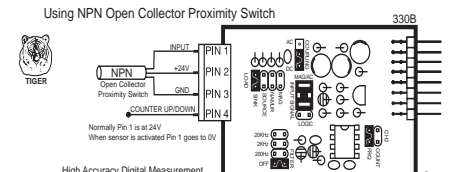

IDD6: Dual Input, DC mV and 4 to 20mA 50mV/4 to 20mA DC

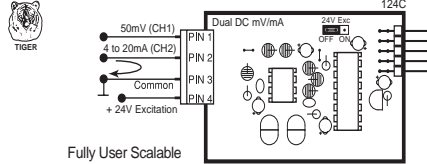

IDS3: Dual Input, Strain Gage and Frequency

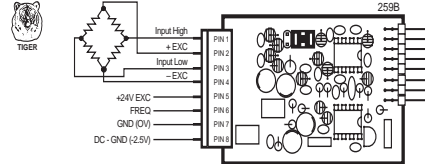

TTL Input Connected to IF10

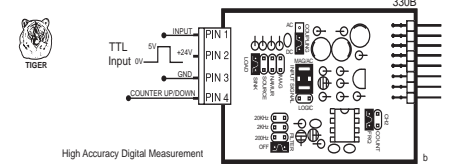

IDF2: Dual Frequency

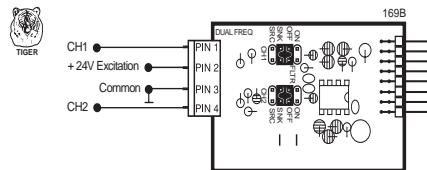

IDT1: Dual Thermocouple (J/K/R/S/T/B/N)

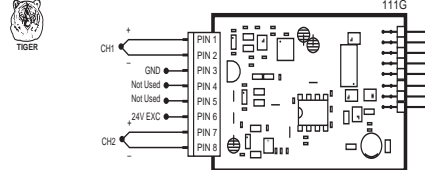

Tach Generator Connected to IF10

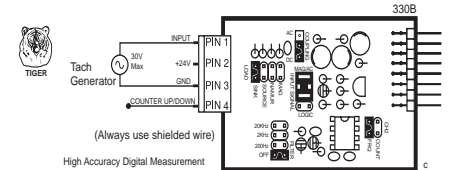

I-Series Input Signal Conditioning Modules continued

NAMUR Sensor Connected to IF10

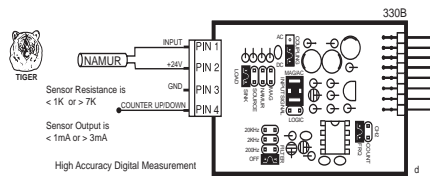

PNP Open Collector Proximity Switch Connected to IF10

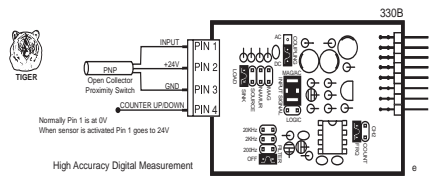

Switch or Dry Contact Connected to IF10

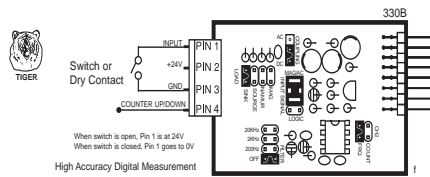

Magnetic Pickup Connected to IF10

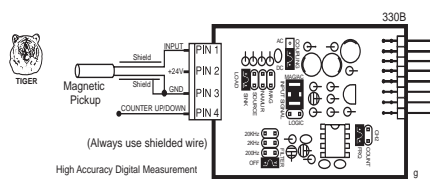

IGYX: Direct Pressure (Absolute or Differential/Gage) with 2 Digital Inputs. See below for ordering code options

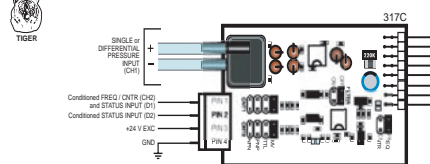

IGYY: Dual Direct Pressure (Absolute or Differential/Gage) see below for ordering code options

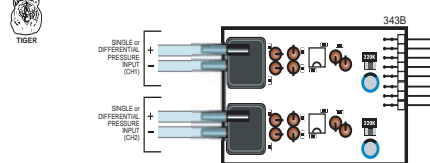

IGYZ: Universal Direct Pressure (Absolute or Differential/Gage) See below for ordering code options

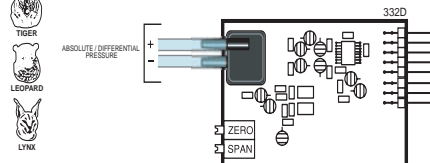

Ordering Code Options for Direct Pressure (IGYX, IGYX & IGYZ)

Sensor Range	CH1 Order Code	CH2 Order Code
1 psi Absolute	A	A
1 psi Differential	B	B
5 psi Absolute	C	C
5 psi Differential	D	D
15 psi Absolute	E	E
15 psi Differential	F	F
30 psi Absolute	G	G
30 psi Differential	H	H
100 psi Absolute	J	J
100 psi Differential	K	K

For Single Channel IGYX with two digital inputs, the last digit of order code is always X.

For Universal Direct Pressure IGYZ, the last digit of order code is always Z.

IHO1: pH IHO2: pH with Automatic Temperature Compensation

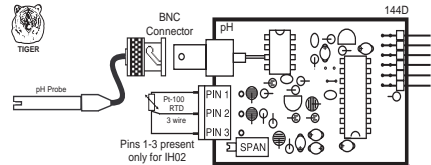

IOR1: ORP (Oxidation Reduction Potential)

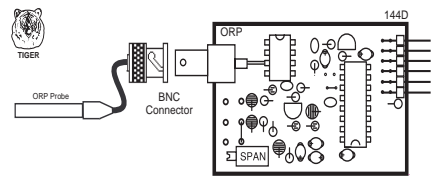

IP01: Process Loop, 4-20mA IP02: Process Loop, 4-20mA with 24VDC EXC

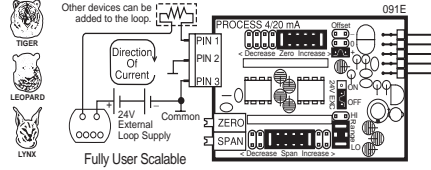

IP03: Process Input, 1-5V DC with Offset, 24V Exc

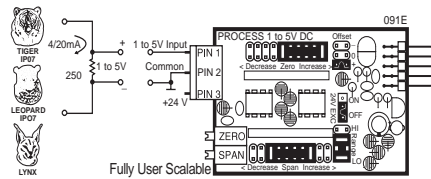

IP06: Process Loop, 4-20mA w/24VDC Exc and Autocal

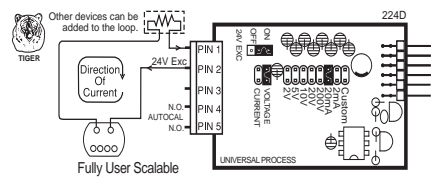

IP07: Universal Process Input 2V/5V/10V/20V/200V/2mA/20mA/Custom

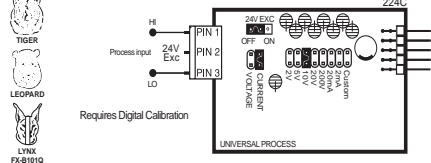

IP08: Universal Process Input with Autocal 2V/5V/10V/20V/200V/2mA/20mA/Custom

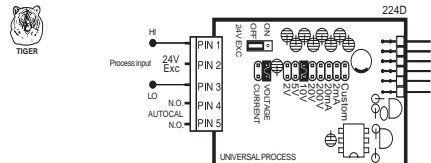

IP09: 4-20mA with External LIN Table Select

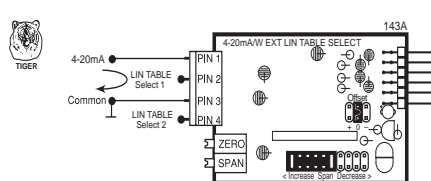

IP10: Process + 3 Digital Inputs

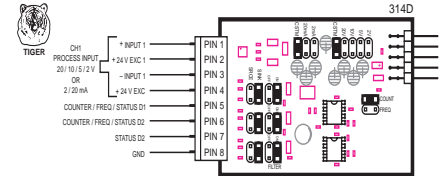

IPT1: Prototype Board for Custom Design

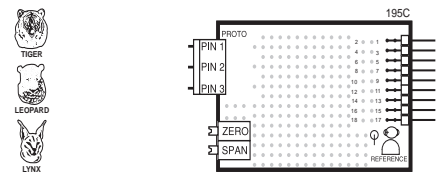

IQD1: Quad DC Volts, 2V DC IQD2: Quad DC mV, 50mV DC

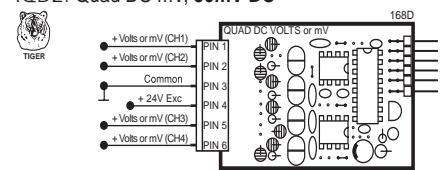

IQP1: Quad 4 to 20mA

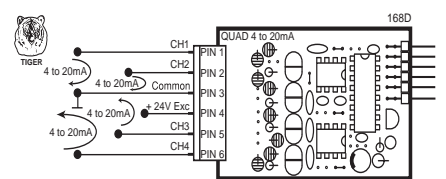

IQT2: Quad RTD Platinum 100 RTD 2 Wire Connection

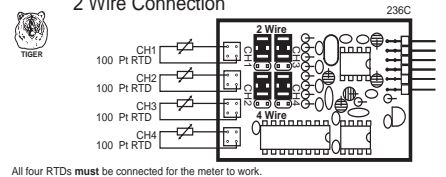

All four RTDs must be connected for the meter to work.

IQT4: Quad RTD Platinum 100 RTD 4 Wire Connection

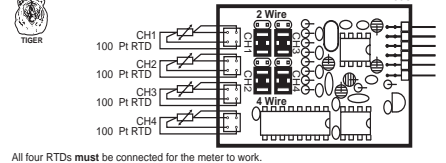

All four RTDs must be connected for the meter to work.

IQT5: Quad RTD / V / V / FREQ

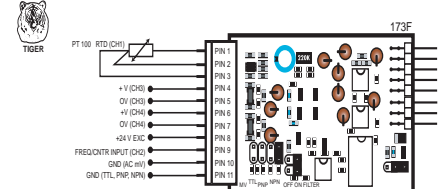

IR01: Resistance, 2/3/4-Wire, 200 / 2K / 20K

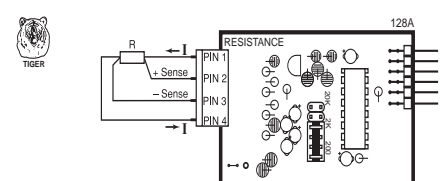

I-Series Input Signal Conditioning Modules continued

IRO3: Linear Potentiometer 1KΩ min

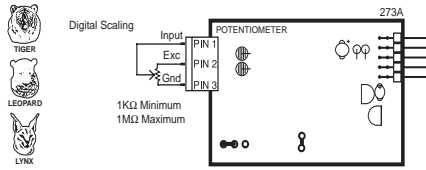

ISO1: Strain Gage 5/10VDC Exc., 20/2mV/V, 4/6-wire
ISO2: Pressure/Load Cell 5/10VDC Exc., 20/2mV/V, 4/6-wire

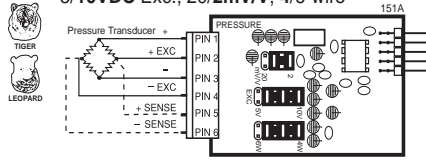

ISO3: Pressure/Load Cell with AutoCal 5/10VDC Exc., 20/2mV/V, 4-wire

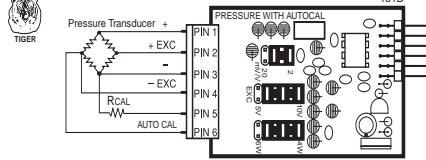

ISO4: Pressure/Load Cell Ext Exc., 20/2mV/V, 4/6-wire

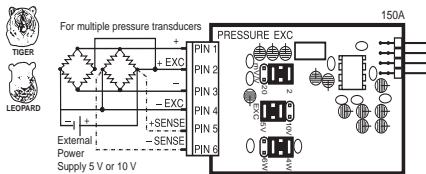

ISO5: Pressure/Load Cell 20/2mV/V, 5/10V Exc 4-wire

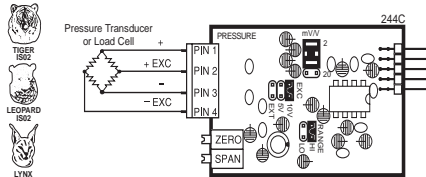

ISO6: Pressure/Load Cell Ext Exc., 20/2mV/V, 4-wire

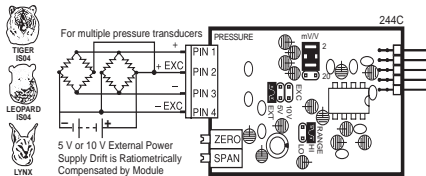

ISO7: Pressure/Load Cell Ext Exc. High Impedance, 20/2mV/V, 4/6-wire

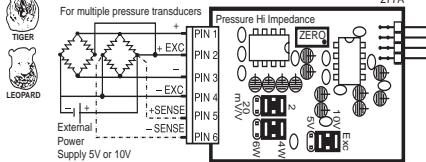

ISD1: Smart DC Volts. 16 bit. Optimized for 50 Hz rejection.
ISD2: Smart DC Volts. 16 bit. Optimized for 60 Hz rejection.
ISD3: Smart DC Volts. 16 bit. 50 Hz rejection w/dual SSRs.
ISD4: Smart DC Volts. 16 bit. 60 Hz rejection w/dual SSRs.

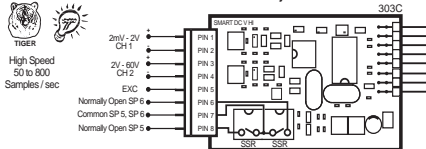

ISD5: Smart DC Volts. 24 Bit. 50 Hz rejection.
ISD6: Smart DC Volts. 24 Bit. 60 Hz rejection.
ISD7: Smart DC Volts. 24 Bit. 50 Hz w/dual SSRs.
ISD8: Smart DC Volts. 24 Bit. 60 Hz w/dual SSRs.

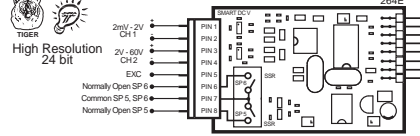

ISD9: Smart Voltage and Resistance Input

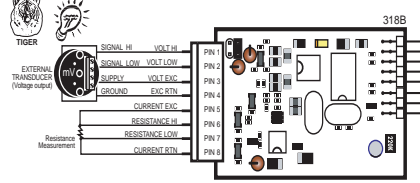

ISDA: Smart Dual DC Volts. 16 bit. 50 Hz rejection.
ISDB: Smart Dual DC Volts. 16 bit. 60 Hz rejection.

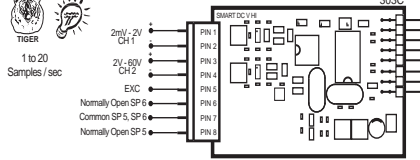

ISL1: Smart Dual LVDT. 50 Hz
ISL2: Smart Dual LVDT. 60 Hz

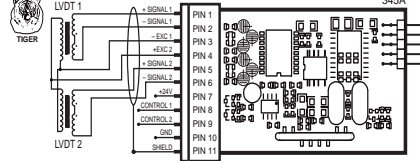

ISM1: Smart Magnetostrictive Input

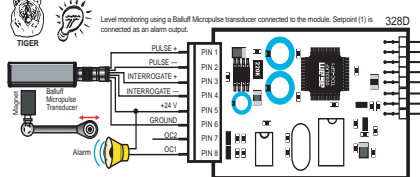

ISP1: Smart Triple Input, Pressure Direct and Dual Counter (Frequency/Counter)

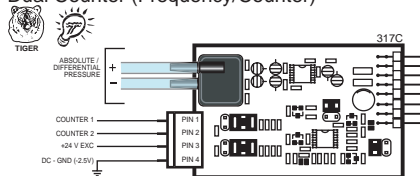

ISR1: Smart Single 3-Wire Potentiometer. 24 bit. 50 Hz
ISR2: Smart Single 3-Wire Potentiometer. 24 bit. 60 Hz

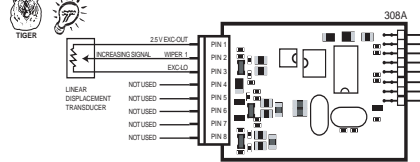

ISR3: Smart Dual 3-Wire Potentiometer. 16 bit. 50 Hz
ISR4: Smart Dual 3-Wire Potentiometer. 16 bit. 60 Hz

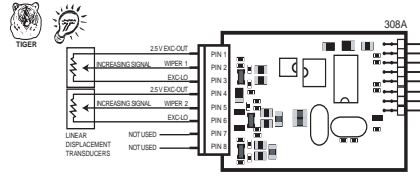

ISS1: Smart Pressure/Load Cell. 16 bit (50 Hz rejection)
ISS2: Smart Pressure/Load Cell. 16 bit (60 Hz rejection)
ISS3: Smart Pressure/Load Cell. 24 bit (50 Hz rejection)
ISS4: Smart Pressure/Load Cell. 24 bit (60 Hz rejection)

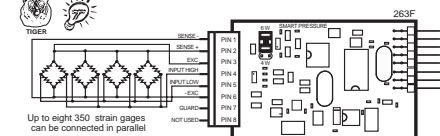

ISS5: Dual Smart Pressure. 16 bit. Optimized for 50 Hz rejection.
ISS6: Dual Smart Pressure. 16 bit. Optimized for 60 Hz rejection.

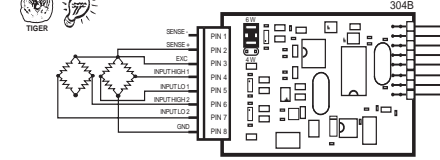

ISS7: Smart Quad Pressure/Load Cell. 16 bit. 50 Hz
ISS8: Smart Quad Pressure/Load Cell. 16 bit. 60 Hz

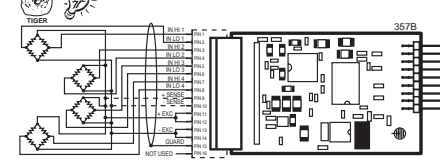

ISS9: Smart Dual Input, LC and Process (4-20mA)

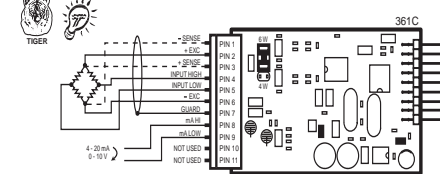

ISSA: Smart Quad Potentiometer/Resistance

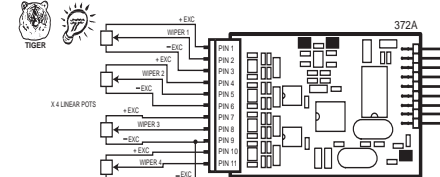

ISSB: Smart Dual Input, Load Cell and RTD

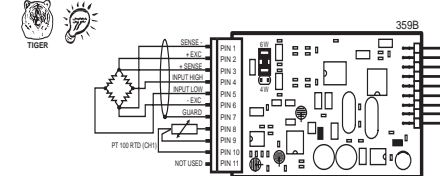

ISSC: Smart Triple Input, 16 bit, Load Cell and two Digital Inputs (Frequency/Counter) (Optimized for 50 Hz)
ISSD: Smart Triple Input, 16 bit, Load Cell and two Digital Inputs (Frequency/Counter) (Optimized for 60 Hz)

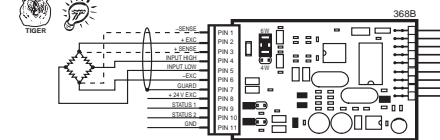

ISSE: Smart Dual Photo Diode Input

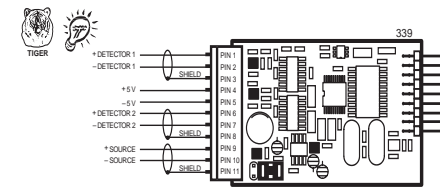

I-Series Input Signal Conditioning Modules continued

IST1: Smart 6 Inputs- 3 RTDs, 2 Proc. & 1 Dig. Input. 50 Hz
 IST2: Smart 6 Inputs- 3 RTDs, 2 Proc. & 1 Dig. Input. 60 Hz

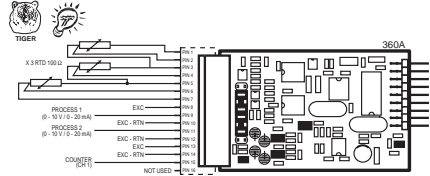

IST3: Smart Quad Thermocouple. 50 Hz
 IST4: Smart Quad Thermocouple. 60 Hz

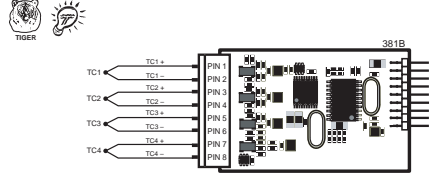

IST5: Smart Dual RTD with 0.01° Res. 50 Hz
 IST6: Smart Dual RTD with 0.01° Res. 60 Hz

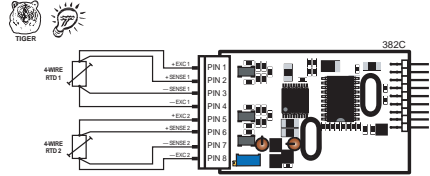

IT01: Thermocouple (J/K/R/S/T/B/N)

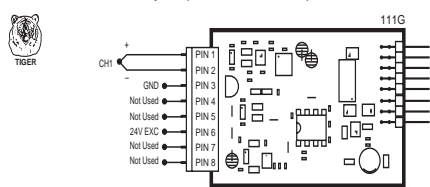

IT02: RTD, 100 Pt. 2.3/4-wire
 IT12: RTD, 120 Nickel 2/ 3/4-wire
 IT13: RTD, 10 Copper 2/ 3/4-wire

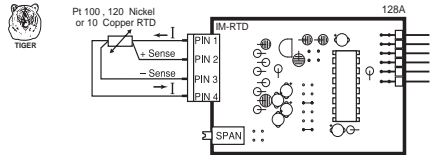

IT03: RTD, 100 Pt. 2/ 3/4-wire (-200 to 800°C)
 IT04: RTD, 100 Pt. 2/ 3/4-wire (-200 to 1470°F)
 IT05: RTD, 100Ω Pt. 2/3/4-wire (-199.9 to 199.9°F)
 IT14: RTD, 100Ω Pt. 2/3/4-wire (-199.9 to 199.9°C)

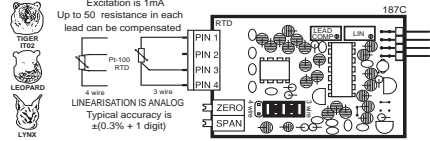

ITD1: Triple DC Volts, 2V DC
 ITD2: Triple DC mV, 50mV DC

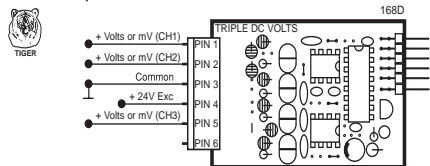

ITP1: Triple 4 to 20mA

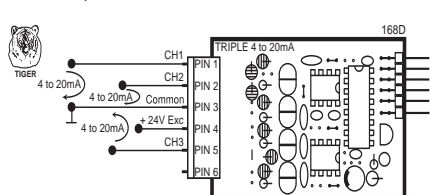

ITT1: Triple Thermocouple (J/K/R/S/T/B/N)

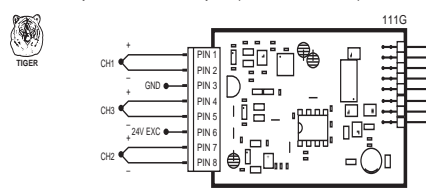

ITT2: Triple RTD Platinum 100 RTD
 2 Wire Connection

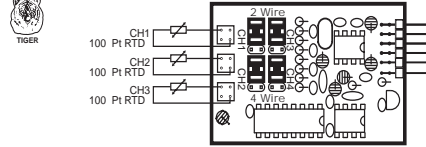

All three RTDs must be connected for the meter to work.

ITT3: Triple Input- T/C, T/C (J/K/R/S/T/B/N)
 and 2VDC Input
 ITT5: Triple Input- T/C, T/C (J/K/R/S/T/B/N)
 and 50mV DC

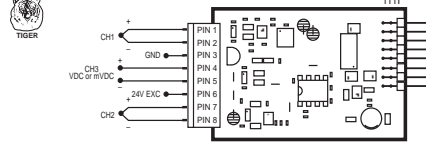

ITT4: Triple Input- T/C, T/C (J/K/R/S/T/B/N)
 and 4 to 20mA

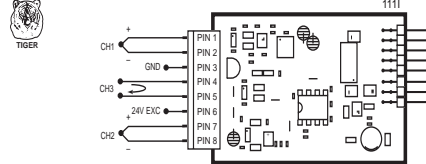

ITT6: Triple Input- T/C (J/K/R/S/T/B/N),
 50mV DC and 50mV DC
 ITT7: Triple Input- T/C (J/K/R/S/T/B/N),
 2VDC and 2VDC

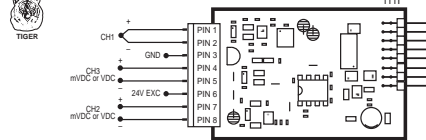

ITT8: Triple Input- T/C (J/K/R/S/T/B/N),
 4 to 20mA and 4 to 20mA

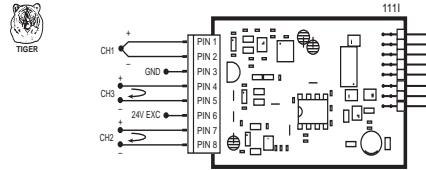

ITT9: Triple Input- T/C (J/K/R/S/T/B/N),
 DCV and 50mV DC

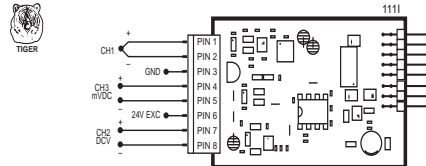

ITTA: Triple Input- T/C (J/K/R/S/T/B/N),
 4 to 20mA and 50mV DC
 ITTB: Triple Input- T/C (J/K/R/S/T/B/N),
 4 to 20mA and 2VDC

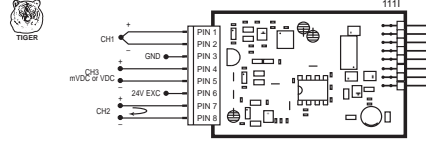

ITTC: Triple RTD Platinum 100 RTD
 4 Wire Connection

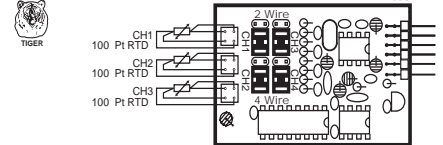

All three RTDs must be connected for the meter to work.

ITTE: Triple Input- RTD / RTD / FREQ

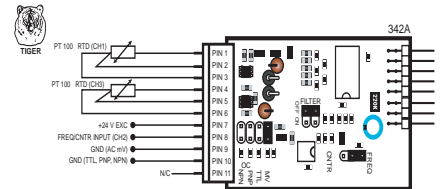

ITTF: Triple Input - Thermocouple / 4-20mA / Frequency
 ITTG: Triple Input - Thermocouple / V / Frequency

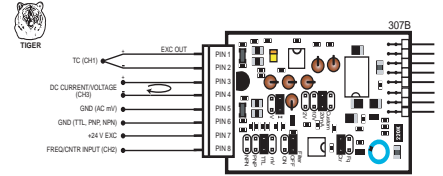

IWO1: Single Phase Power, 300V/1A
 IWO2: Single Phase Power, 300V/5A
 IWO4: Single Phase Power, 700V/1A
 IWO5: Single Phase Power, 700V/5A

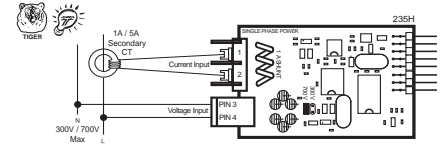

IWO3: DC-Watts, 10V/50mV DC

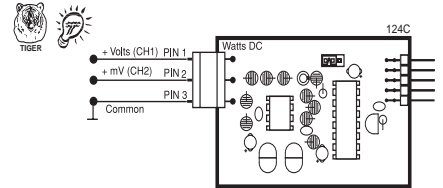

INPUT MODULE COMPONENT GLOSSARY

Dual input modules, and those modules exclusively compatible with the Leopard or Tiger Families, do not have zero and span adjustments. These modules are scaled and calibrated using the internal software functions of each individual meter.

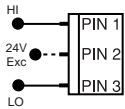

Input and Output Pins

On most modules Pin 1 is the Signal High input and Pin 3 is the Signal Low input. Typically Pin 2 is used for Excitation Voltage output.

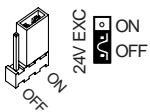

24 V DC Output for 4-20 mA Header

On some modules this header enables a 24 V DC 25 mA (max) Excitation/Auxiliary output to be connected to Pin 2 that can power most 4-20 mA transmitters.

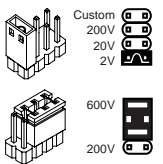

INPUT RANGE Headers

Range values are marked on the PCB. Typically two to eight positions are provided, which are selected with either a single or multiple jumper clip. When provided, a custom range position is only functional when the option has been factory installed.

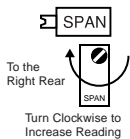

SPAN Potentiometer (Pot)

If provided, the 15 turn SPAN pot is always on the right side (as viewed from the rear of the meter). Typical adjustment is 20% of the input signal range.

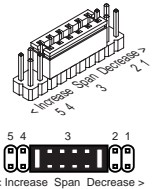

SPAN ADJUST Header

This unique five-position header expands the adjustment range of the SPAN pot into five equal 20% steps, across 100% of the input Signal Span. Any input Signal Span can then be precisely scaled down to provide any required Display span from full scale to the smallest viewable unit.

SPAN Adjust Header position	1	2	3	4	5
SPAN Pot %	20%	20%	20%	20%	20%
Signal Span %	20%	40%	60%	80%	100%

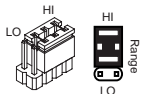
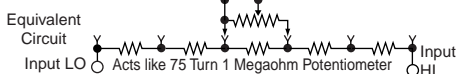

SPAN RANGE Header

When this header is provided it works in conjunction with the SPAN ADJUST Header by splitting its adjustment range into a Hi and a Lo range. This has the effect of dividing the adjustment range of the SPAN pot into ten equal 10% steps across 100% of the input Signal Span.

SPAN Adjust Header position	LO RANGE					HI RANGE				
	1	2	3	4	5	1	2	3	4	5
SPAN Pot %	10%	10%	10%	10%	10%	10%	10%	10%	10%	10%
Signal Span %	10%	20%	30%	40%	50%	60%	70%	80%	90%	100%

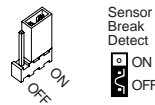
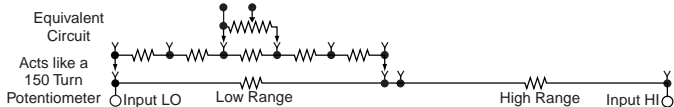

Function Select Headers

On some modules various functions such as Amps and Volts, 4 wire and 6 wire, or cold junction compensation are selected by header positions that are marked on the PCB.

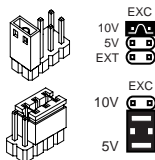
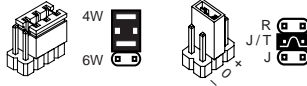

Excitation Output Select Headers

When excitation outputs are provided, they are typically 5 V DC max 30 mA, 10 V DC max 30 mA (300Ω or higher resistance) or external supply. They are selected by either a single or multiple jumper clip.

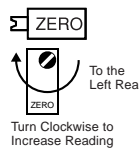

ZERO Potentiometer (Pot)

If provided, the ZERO pot is always to the left of the SPAN pot (as viewed from the rear of the meter). Typically it enables the input signal to be offset ±5% of the full scale display span.

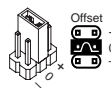
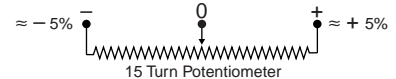

ZERO OFFSET RANGE Header

When provided, this three position header increases the ZERO pot's capability to offset the input signal, by ±25% of the full scale display span. For example a Negative offset enables a 1 to 5 V input to display 0 to full scale. The user can select negative offset, positive offset, or no offset (ZERO pot disabled for two step non-interactive span and offset calibration).

NEGATIVE OFFSET Decreases Digital Reading		POSITIVE OFFSET Increases Digital Reading	
ZERO Pot%	- 100% of Offset	- 0 +	+ 100% of Offset
Offset Range	≈ - 25%	No Offset Zero Pot Disabled	≈ + 25%

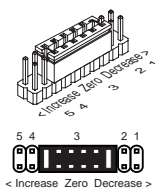

ZERO ADJUST Header

When this header is provided, it works in conjunction with the ZERO OFFSET RANGE Header, and expands the ZERO pot's offset capability into five equal negative steps or five equal positive steps. This enables virtually any degree of input signal offset required to display any desired engineering unit of measure.

ZERO Adjust Header Position	NEGATIVE OFFSET					POSITIVE OFFSET				
	5	4	3	2	1	1	2	3	4	5
ZERO Pot Span	6400	6400	6400	6400	6400	6400	6400	6400	6400	6400
Offset Range	-25200 to +31600	-18900 to -25300	-12600 to -19000	-6300 to -12700	0 to -6400	0 to +6400	+6300 to +12700	+12600 to +19000	+18900 to +25300	+25200 to +31600

CALIBRATE position, Zero Pot disengaged (no offset applied)

Case Dimensions

PANEL CUTOUT

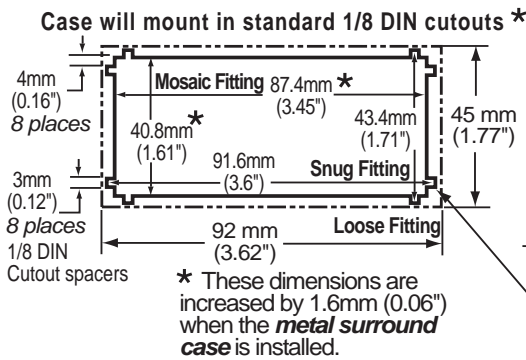

SIDE VIEW

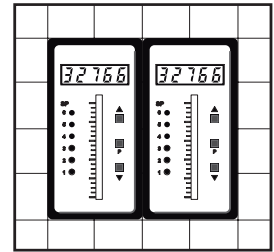
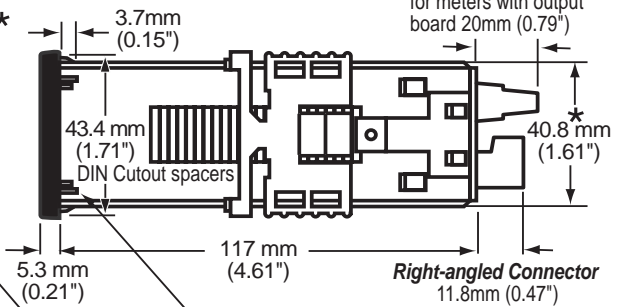

The 96x48mm case is particularly suitable for mounting in mosaic panels or insulative panels up to 2" thick. They can also stack mount, 2 up in existing cutouts for 1/4 DIN (96x96mm) or 4 up in 1/2 DIN (96x192mm).

For extra strength in portable applications, the 8 DIN spacers should be snipped off and the **Mosaic fitting** cutout used. Alternatively, the **High Strength Panel Mounting Kit** (Part # OP-PMA96X48) can be used.

When extra panel mounting tightness is required, order the optional **screw mount clip**.
P/N: (OP-MTLCLIP)

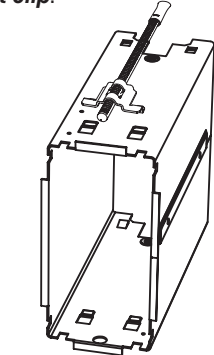
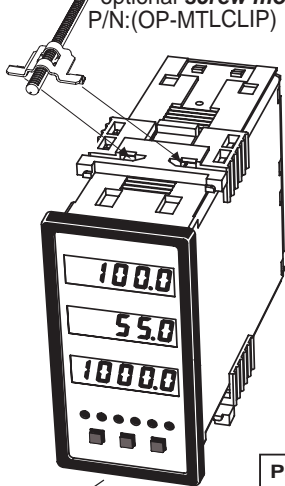

Metal Surround Case
(P/N: OP-MTL96X48)

Metal Surround Case uses **Metal Screw Mount Clips** and has a max. panel thickness mounting of 15.5 mm (0.61").

NOTE: The Metal Surround Case is pre-installed at the factory and cannot be removed without damage to the case.

TOP VIEW

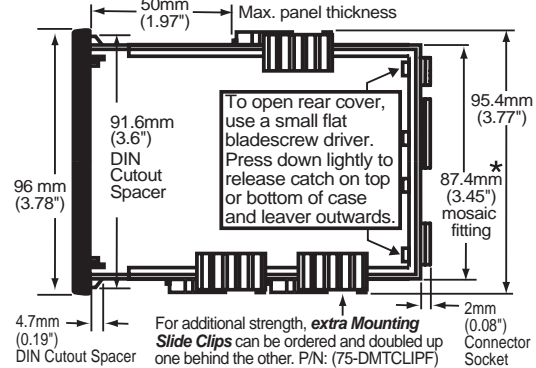

FRONT VIEW

1/8 DIN 48x96mm

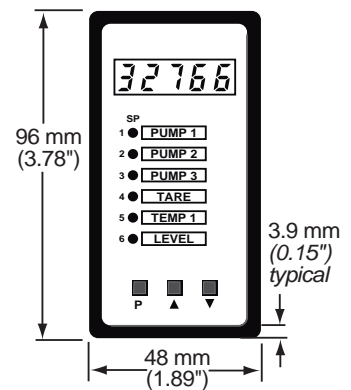

Panel adaptor plates are available to retrofit most existing panel cutouts.

Various bezel colors are available. Black is standard.

96x48 Panel to Case Seal Adaptor Kit
P/N: OP-PMA96X48

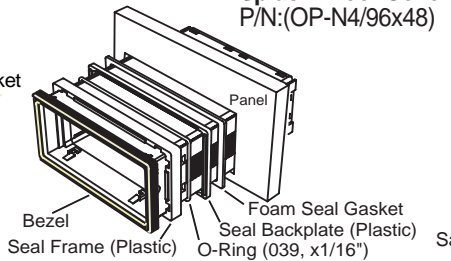
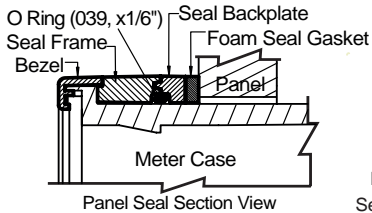

Clear Lockable NEMA 4X Splash Proof Cover
P/N: (OP-N4/96x48)

WARRANTY

Texmate warrants that its products are free from defects in material and workmanship under normal use and service for a period of one year from date of shipment. Texmate's obligations under this warranty are limited to replacement or repair, at its option, at its factory, of any of the products which shall, within the applicable period after shipment, be returned to Texmate's facility, transportation charges pre-paid, and which are, after examination, disclosed to the satisfaction of Texmate to be thus defective. The warranty shall not apply to any equipment which shall have been repaired or altered, except by Texmate, or which shall have been subjected to misuse, negligence, or accident. In no case shall Texmate's liability exceed the original purchase price. The aforementioned provisions do not extend the original warranty period of any product which has been either repaired or replaced by Texmate.

USER'S RESPONSIBILITY

We are pleased to offer suggestions on the use of our various products either by way of printed matter or through direct contact with our sales/application engineering staff. However, since we have no control over the use of our products once they are shipped, NO WARRANTY WHETHER OF MERCHANTABILITY, FITNESS FOR PURPOSE, OR OTHERWISE is made beyond the repair, replacement, or refund of purchase price at the sole discretion of Texmate. Users shall determine the suitability of the product for the intended application before using, and the users assume all risk and liability whatsoever in connection therewith, regardless of any of our suggestions or statements as to application or construction. In no event shall Texmate's liability, in law or otherwise, be in excess of the purchase price of the product.

Texmate cannot assume responsibility for any circuitry described. No circuit patent or software licenses are implied. Texmate reserves the right to change circuitry, operating software, specifications, and prices without notice at any time.

TEXMATE INC

995 Park Center Drive • Vista, CA 92081-8397

Tel: 1-760-598-9899 • USA 1-800-839-6283 • That's 1-800-TEXMATE

Fax: 1-760-598-9828 • Email: sales@texmate.com • Web: www.texmate.com

Texmate has facilities in Japan, New Zealand, Taiwan, and Thailand. We also have authorized distributors throughout the USA and in 28 other countries.

For product details visit www.texmate.com

Local Distributor Address