

DU-35MV

**50/100/200mV DC Full Scale
3 1/2 Digit with 0.56" LEDs
in a 1/8 DIN Case**

Measuring DC signals as low as 50mV full scale, this meter is ideal for use with low voltage drop current shunts or other precision low DC measurements.

General Features

The DU-35MV is an economical, low DC voltage measuring meter with three header selectable full scale ranges of 50mV, 100mV and 200mV. The meter is particularly suited for measuring DC current using 50mV standard current shunts. After selecting a new range, re-calibration is required. Display Hold and Display Test functions are also provided.

The standard meter has a high efficiency red LED display and user selectable AC power inputs of 100V AC to 120V AC or 200V AC to 240V AC are provided. An Optional 24V AC or an auto sensing isolated AC/DC 24V switching power supply can be ordered. (See ordering information)

Typical Application Connections

DC Current measurement using 50mV Shunt.
Easily User Scaled to Display Currents up to 1999 Amps.

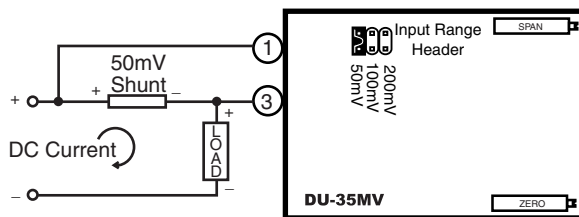

Shunt may be in Hi or Lo side of Load.

DC mV measurement with a Resolution of 100 microVolts.
Easily User Scaled to Display Voltages up to 199.9 mV.

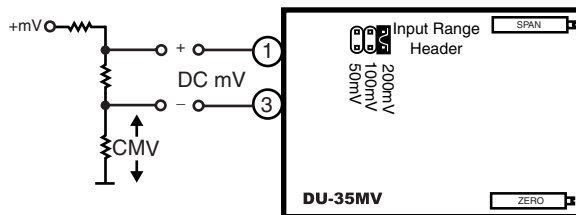

Can be used to measure single-ended or differential inputs.
Max CMV (common mode voltage) is 50V*.
Because CMV is common with meter ground, higher CMV inputs to a max of 1KV require mechanical isolation of all contactable meter parts.

Compatibility

The DU-Series have a matching DIN case style that is complementary to the Lynx, Leopard and Tiger family of meters. DU-Meters are the OEM's choice for economical switchboard and process indication. For economy, each model is dedicated to a specific application and designed for quick and easy installation.



Specifications

- Input Configuration:**Single-ended, however isolated power supply enables differential measurements up to a maximum common mode of 50V.*
- Full Scale Ranges:**Three header selectable ranges of $\pm 50\text{mV}$ DC, $\pm 100\text{mV}$ DC & $\pm 200\text{mV}$ DC full scale
- Input Impedance:**50K Ω /100K Ω /65K Ω in 50/100/200 ranges
- A/D Converter:**12 Bit Dual Slope
- Accuracy:** $\pm (0.05\%$ of reading + 3 digits)
- Temperature Coefficient:** 100ppm/ $^{\circ}\text{C}$ (Typical)
- Warm Up Time:**One minute to specified accuracy
- Conversion Rate:**3 readings per second
- Display:**0.56" hi efficiency Red or optional Green LEDs.
Display Hold & Display Test are provided.
- Polarity:**Bipolar. Assumed positive, displays negative
- Decimal Selection:**Header under face plate, X•X•X•X•
- Over-range Indication:** ...The MSD digit 1 is displayed with all other digits blank
- Power Supply (std):**120/240V AC, 50/60 Hz. approx 2.5W.
(Optn) VO-DC/ISOIsolated Switcher. 9 to 36V DC/12 to 24V AC
(Optn) VO-24VIsolated Transformer 24V AC $\pm 10\%$
(Optn) VO-5V DCNon-isolated 5V DC $\pm 10\%$
- Operating Temperature:**-10 to 50 $^{\circ}\text{C}$
- Storage Temperature:**-20 to 70 $^{\circ}\text{C}$
- Relative Humidity:**95% (non-condensing)
- Case Dimensions:**1/8 DIN, Bezel: 96x48mm (3.78"x1.89")
Depth behind bezel 117 mm (4.61") plus 11.8mm (0.47") for Right-angled Connector or 20mm (0.79") for Straight-through Connectors.
- Weight:**11 oz., 14 oz when packed

DU-Series, the OEMs choice for switchboard and process indication

- DU-35AC11/5**AC amps, Scaled RMS. (1 or 5 Amp Internal shunt), 3.5 digit
- DU-35ACIRMS1/5** ..AC amps, True RMS. (1 or 5 Amp Internal shunt), 3.5 digit
- DU-40AC11-5**AC amps, Scaled RMS. (1 or 5 Amp Internal shunt), 4 digit
- DU-35AC**AC volts, Scaled RMS. **199.9/700V** AC Header Selectable Ranges, 3.5 digit
- DU-35ACRMS**AC volts, True RMS **199.9/700V** AC Header Selectable Ranges, 3.5 digit
- DU-40AC**AC volts, Scaled RMS. **700.0V AC** full scale, 4 digit
- DU-35HZ****15.0Hz** to **199.9Hz** or 15/500Hz. Up to 700V AC input, 3.5 digit
- DU-35**DC volts $\pm 2\text{V}/\pm 20\text{V}/\pm 200\text{V}$ Header Selectable Ranges, 3.5 digit
- DU-35MV**DC mV $\pm 50\text{mV}$, $\pm 100\text{mV}$, $\pm 200\text{mV}$ Header Selectable Ranges, 3.5 digit
- DU-45**DC volts $\pm 2\text{V}/\pm 20\text{V}/\pm 200\text{V}$ Header Selectable Ranges, 4.5 digit
- DU-45MV**DC mV $\pm 50\text{mV}/\pm 100\text{mV}/\pm 200\text{mV}$ Header Selectable Ranges, 4.5 digit
- DU-35CL**Process 4 to 20mA (**100.0**), easily user scalable, 3.5 digit
- DU-35CLE**Process 4 to 20mA (**100.0**) with 24V DC excitation, scalable, 3.5 digit
- DU-45CL**Process 4 to 20mA (**100.00**), easily user scalable, 4.5 digit
- DU-35P**Pressure, strain gage and load cell, 4 and 6 wire, 5V DC excitation, Header Selectable Sensitivity 2mV/V, 5mV/V, 10mV/V, **20mV/V**, 3.5 digit
- DU-35J/K**Order **J** or **K** Thermocouple and $^{\circ}\text{C}$ or $^{\circ}\text{F}$, 3.5 digit
- DU-35RTD**100 Ω platinum RTD, 3 or 4 wire, order $^{\circ}\text{C}$ or $^{\circ}\text{F}$ and **0.1 $^{\circ}$** or **1 $^{\circ}$** , 3.5 digit

Functional Diagram

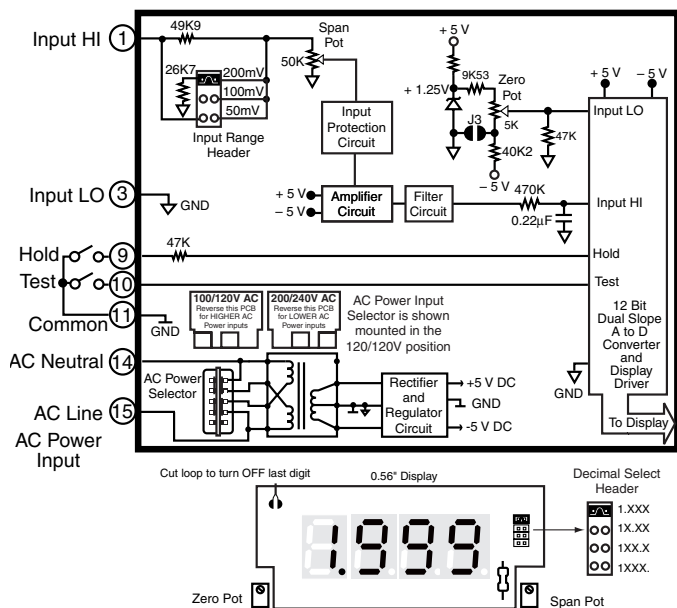

Connector Pinouts

This meter is supplied with plug-in type screw terminal connectors. The power supply pins (14 & 15) have a unique plug and socket outline to prevent cross connection. (see DU Connectors)

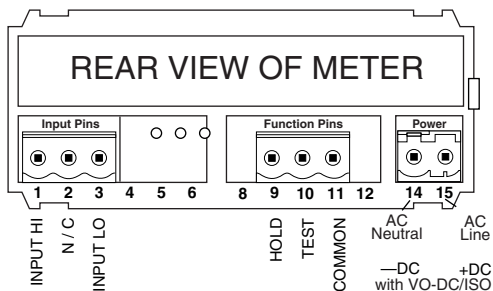

WARNING: AC and DC input signals and power supply voltages can be hazardous. Do Not connect live wires to screw terminal plugs, and do not insert, remove or handle screw terminal plugs with live wires connected.

Pin 1 - Signal Input High: Signal high input for the meter. Full scale ranges of 50mV, 100mV or 200mV can be selected on the Range Select Header.

Pin 3 - Signal Input Low: Signal low input for the meter.

Pin 9 - Hold Reading: If this Pin is left unconnected, the meter will operate in a free-running mode. When this pin is connected to the Hold/Test Common Pin 11, the meter will latch up. A/D conversions will continue, but the display will not be updated until Pin 9 is disconnected from the Hold/Test Common pin 11.

Pin 10 - Display Test: All numeric display segments will light up when this pin is connected to the Hold/Test Common Pin 11.

Pin 11 - Hold/Test Common: The Hold and Display Test Pins have to be connected to this pin to activate their respective functions.

Pins 14 & 15 - AC Power Input: These pins are the Power Input pins for the meter. All DU-Series meters sold in North America are pre-configured at the factory for 100/120V AC operation. To re-configure for 200/240V AC operation, simply pull out the AC Power Voltage Selector located directly behind the transformer, turn it around and re-insert it into the socket so that "200/240V AC" is visible. Various other AC/DC power options are available. See Ordering Information on page one for details.

Component Layout

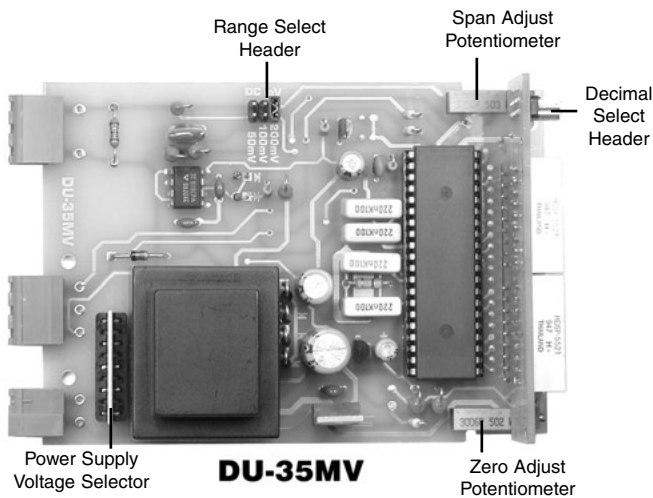

Signal Conditioning Components

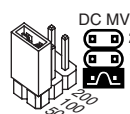

INPUT RANGE Header

Range values are marked on the PCB. Three positions are provided. After selecting a new range with the single jumper clip, re-calibration is required.

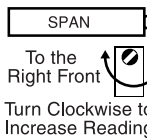

SPAN Potentiometer (Pot)

The 15 turn SPAN pot is always on the right side (as viewed from the front of the meter). Typical adjustment is 20% of the input signal range.

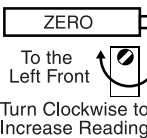

ZERO Potentiometer (Pot)

The ZERO pot is always to the left of the SPAN pot (as viewed from the front of the meter). Typically it enables the displayed reading to be offset ± 1000 counts.

Calibration Procedure

1. Select the required full scale voltage range, by repositioning the jumper clip on the range select header.
2. Apply an input of 0 millivolts. Adjust the zero offset pot until the meter reads 000.
4. Apply a known high input signal that is within the full scale voltage range selected.
5. Adjust the Span Pot until the meter displays the required reading for the signal being applied.
6. The DU-35MV is now calibrated and ready for use.

(Whenever a new range is selected, re-calibration is required to meet the specified accuracy).

Decimal Point Selection

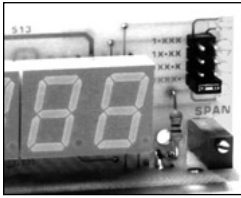

Decimal selection is made on the front of the display board by moving the jumper to the indicated position on the header for the decimal required.

Rear Selection of Decimal Points

An optional output board is available that provides access to all decimal points via a rear PCB edge connector.

Opening Back Panel



To open back panel, insert a flat screwdriver or similar instrument in both slots on the top of the case and pry open. The DU-Series meters slide out from the rear of the case as a complete assembly.

Selecting Power Supply Voltage

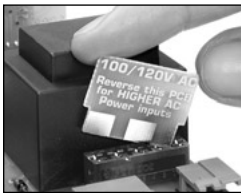

This unique voltage selector PCB displays the operating voltage selected. To change the voltage, disconnect power to the meter. Remove the selector, reverse the selector and fully re-insert it in the socket. This selector is not required for optional power supplies.

DU-Series Connector Options

Plug-in Screw Terminal Connectors are Provided

Input Power Screw Terminal Plug

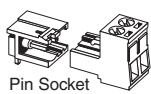

Part Number:
93-PLUG2P-DP

Right-angled Screw Terminal Plug

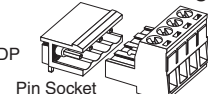

Part Numbers:
93-PLUG2P-DR.....2 pins
93-PLUG3P-DR.....3 pins
93-PLUG4P-DR.....4 pins
93-PLUG5P-DR.....5 pins
93-PLUG6P-DR.....6 pins

Spade Lug pinouts and insulated quick disconnects may still be ordered as an option. P/N.:CN-SPADE.

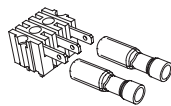

Metal Surround Case Option

The meter's plastic case is made from fire retardant polycarbonate. A metal surround case can be ordered to enhance the meter's fire retardant capabilities and also provide shielding against electromagnetic interference (EMI). The metal case slides over the polycarbonate case and is held firmly in place by spring-type non-return clips. The Metal Surround Case must be factory installed on the polycarbonate case and once installed, it cannot be removed in the field.

With the metal case in place, the meter's standard ratchet-type mounting clips can not be used. Instead a pair of screw-type DIN standard mounting clips are provided, which clip into holes on the side of the metal case and tighten against the rear of the panel. A ground tab on the metal case enables the metal case to be easily connected to the panel ground.

Part No.
OP-MTL96X48

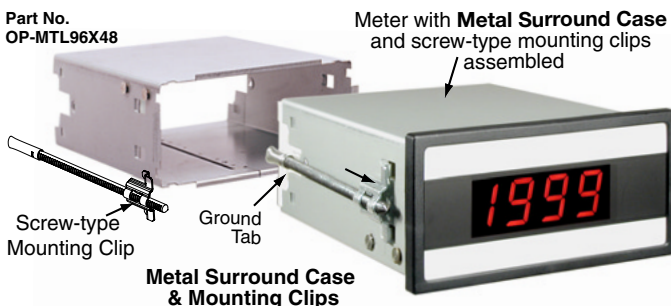

Face Plate Descriptors

AC	Ω	kV	kVAR	m ³ /hr	Hz	RPM
V	mV	min	PF	°F	°C	Cosθ
DC	x10kN	μA	PSIG	mS	kg/cm ²	psi
kW	W	kWH	pH	%	K	kPa
A	mbar	mA	MW	kA	RPS	MWH
mWs	μm	kW/s	l	l/sec	ml	cm
ORP	mm/s	1/min	mm	kg/sec	lbs	kg/hr
FT	bars	min ¹	m/min	Mvars	μV	dB

To customize the face plate, each DU-meter is supplied with a white printed clear adhesive label containing various popular descriptors. Choose the descriptor desired, peel off the adhesive backing and align the descriptor in the center right of the faceplate.

Custom Face Plates



Texmate Produces Thousands of Custom OEM Face Plates

Have Texmate Design and Build a Custom Face Plate to Suit your Next project!

- Custom face plates have a non-recurring artwork charge. A serial number is then assigned to each artwork, to facilitate re-ordering.

- Small Run or One-Off custom face plates incur an installation charge, and are generally printed on a special plastic film, which is then laminated to custom faceplate blanks as required.
- Large Run (250 pieces min): custom face plates are production silk screened, issued a part number, and held in stock for free installation as required by customer orders.
- OEMs may also order Custom Meter Labels, Box Labels Custom Data Sheets and Instruction Manuals.

Optional Display Styles



DU Series Above-Center Display Option



0.8" LED Options available in Lynx Family

To match all display styles, DU-Meters have an optional display and faceplate with the digits positioned above center. (see Display Options)

For 0.8" LEDs in 1/8 DIN cases order Lynx family DX-35 and DX-40 w/ LR or LG displays and input modules that match DU-Series inputs.

Clear Lockable Water-proof Cover

The clear lockable cover is designed to be dust and water proof to NEMA-4X, IP65 standards. The assembly consists of a base and cover with a cam hinge and key-lock fastening mechanism. An O-ring, or neoprene gasket forms a seal between the base and the panel. The cam hinge prevents the cover from closing when opened until pushed closed. The cover has a tapered recess that, when closed, forms a seal with a tapered spigot on the base. A key-lock employs a cam locking device to force the spigot into the recess, ensuring seal integrity. A safety catch keeps the cover closed even when the key is removed, and the keyhole can be used to attach a safety seal clip, preventing unauthorized opening.

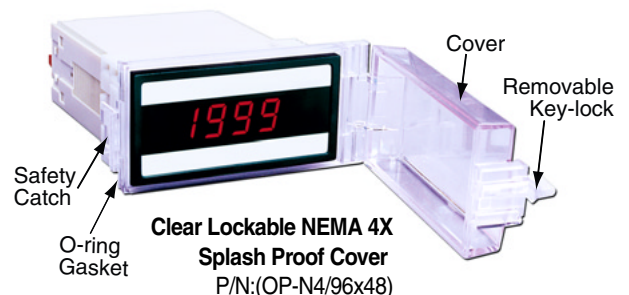

DU Case Dimensions and Panel Cutouts

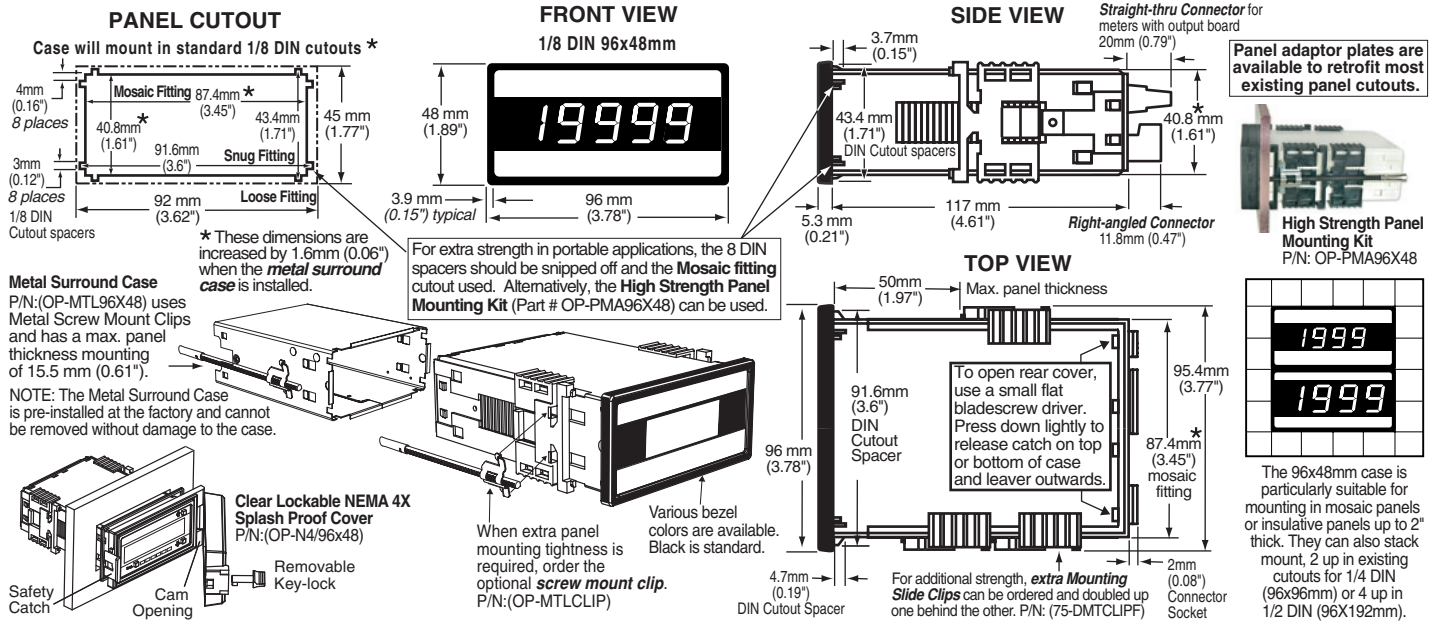

Ordering Information

Standard Options for this Model Number

Part Number	Description
► BASIC MODEL NUMBER Includes plug in type screw terminals, standard display and standard power supply unless optional versions are ordered.	
DU-35MVDPM, DC mV ±50mV, ±100mV, ±200mV Header Selectable Ranges
► DISPLAY	
STANDARD.....Red LEDs, 0.56 inch high	
DU-BRIGHTSuper bright Red LEDs, 0.56 inch high
DU-GREENGreen LEDs, 0.56 inch high
DU-GREEN 4.5DDummy Zero Display Option w/ Green LEDs
DU-RED4.5DDummy Zero Display Option w/ Green LEDs
DU-35HI/BRTAbove center position, .56 inch, Bright Red LED
DU-35HI/GRNAbove center position, .56 inch, Green LED
DU-35HI/REDAbove center position, .56 inch, Red LED
► POWER SUPPLY	
STANDARD.....100/120 or 200/240VAC User selectable	
V0-DC/ISOIsolated auto-sensing AC/DC 9 to 36 VDC/12 to 24 VAC
V0-24VIsolated transformer 12 VAC or 24 VAC user selectable
► SPECIAL OPTIONS (Specify Inputs or Outputs & Req. Reading)	
HD-CHANGERange change from the standard input as shown in BOLD type
CB-FS35Non-Std Range and Scale Changes for all DU-35 series

Special Options and Accessories

Part Number	Description
► ACCESSORIES (Specify Serial # for Custom Artwork Installation)	
75-DBBZ9648FBlack Bezel for 96x48mm Case
75-DMTCLIPFSide Slide Brackets (2 pc) - extra set, extra strength
76-DU35GReplacement DU Series grey lens for Green LEDs
76-DU35RReplacement DU Series red lens for Red LEDs
76-DUPP/NAnti-glare protective front lens plate for DU Series
76-DUPP/NAnti-glare protective front lens plate for DU Series
93-PLUG2P-DPExtra Screw Terminal Conn., 2 Pin Power Plug
93-PLUG3P-DRExtra Screw Terminal Conn., 3 Pin Plug
CN-SPADESpade Lug pinouts and Insulated quick disconnects
DN•CAS96X48AComplete 96x48mm Case with bezel
OP-DUEXTDPOption for External Decimal Point
OP-MCLP96X48Screw Mounting Clips (2 pc) to screw tighten slide brackets
OP-MTL96X48Metal Surround Case includes metal mounting clips
OP-N4X/96X48Clear Lockable Water-proof cover, Nema 4X, IP65
QD-KIT-1Replacement Crimp-on Quick Disconnects (7 per Set)
ART-FS-S/DNRC for Artwork & set-up Custom Faceplate and/or Descriptor
ART-FS-D/CNRC for Artwork & set-up Custom Faceplate and Custom Logo
ART-FS-001Produce & Install Custom Faceplate per meter - 1 color no-min
ART-FS-002Produce & Install Custom Faceplate per meter - 2 color no-min
ART-FS-003Produce & Install Custom Faceplate per meter - 3 color no-min
ART-FL-001Custom Faceplate, 250 piece Min. (\$1.00 each) - 1 color
ART-FL-002Custom Faceplate, 250 piece Min. (\$1.40 each) - 2 color
ART-FL-003Custom Faceplate, 250 piece Min. (\$1.80 each) - 3 color
Many other options and accessories are available. See full price list for more details. Prices subject to change without notice.	

WARRANTY

Texmate warrants that its products are free from defects in material and workmanship under normal use and service for a period of one year from date of shipment. Texmate's obligations under this warranty are limited to replacement or repair, at its option, at its factory, of any of the products which shall, within the applicable period after shipment, be returned to Texmate's facility, transportation charges pre-paid, and which are, after examination, disclosed to the satisfaction of Texmate to be thus defective. The warranty shall not apply to any equipment which shall have been repaired or altered, except by Texmate, or which shall have been subjected to misuse, negligence, or accident. In no case shall Texmate's liability exceed the original purchase price. The aforementioned provisions do not extend the original warranty period of any product which has been either repaired or replaced by Texmate.

USER'S RESPONSIBILITY

We are pleased to offer suggestions on the use of our various products either by way of printed matter or through direct contact with our sales/application engineering staff. However, since we have no control over the use of our products once they are shipped, **NO WARRANTY WHETHER OF MERCHANTABILITY, FITNESS FOR PURPOSE, OR OTHERWISE** is made beyond the repair, replacement, or refund of purchase price at the sole discretion of Texmate. Users shall determine the suitability of the product for the intended application before using, and the users assume all risk and liability whatsoever in connection therewith, regardless of any of our suggestions or statements as to application or construction. In no event shall Texmate's liability, in law or otherwise, be in excess of the purchase price of the product.

Texmate cannot assume responsibility for any circuitry described. No circuit patent or software licenses are implied. Texmate reserves the right to change circuitry, operating software, specifications, and prices without notice at any time.



995 Park Center Drive • Vista, CA 92081-8397

Tel: 1-760-598-9899 • USA 1-800-839-6283 • That's 1-800-TEXMATE

Fax: 1-760-598-9828 • Email: sales@texmate.com • Web: www.texmate.com

Texmate has facilities in Japan, New Zealand, Taiwan, and Thailand. We also have authorized distributors throughout the USA and in 28 other countries.

For product details visit www.texmate.com

Local Distributor Address