

# 3 phase Power Meter

Voltage Range 600V,  
Current Range 0.5~5A or 0.05~1A (Optional)  
Includes RS-485 Modbus RTU with 2 Digital Inputs  
Optional Two Relays

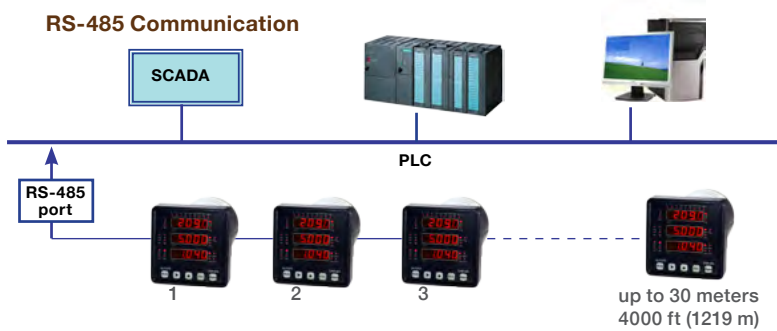

Model: CPW-503

## Specification

- Display: Red LED 0.4" high
- Over range Indication: " o.L "
- Conversion Rate: 1 / sec
- Isolation: Input / Output / Power / Case
- Operating Temp.: 0~60°C / Below 90%R.H.
- Storage Temp.: -10~70 / Below 80%R.H.
- Temp. Coefficient: ±0.1% F.S /°C
- CT, PT ratio: 1~9999
- Interface: RS-485
- Power Supply: 85-264 VAC / 120-370 VDC
- Option: DC 24V
- Power Consumption: Approx. 7VA
- Dielectric Strength:
  - DIN-IEC688, AC 2.3KV/1min, between terminal.
  - AC 2.8KV/1min, between terminal and case.
- Isolation Resistance: DC 500V, 100MΩ at above terminals
- Dimensions: 110mm(W) x 110mm(H) x 140mm(D)

### Input

- Voltage: V1, V2, V3, (3 phase voltage) and Neutral
- Range : 600V<sup>L-L</sup> / 347 V<sup>L-N</sup>
- Current: 1S, 1L, 2S, 2L, 3S, 3L (3 phase current)
- Range: 0.5~5A , 0.05~1A (optional)
- Over load: Voltage.....750V continuous
  - 1.25 x rated continuous.
  - Current.....3 x rated continuous
  - 10 x rated for 10 sec.

- Burden: ≤0.2VA per Voltage circuit
- ≤0.2VA per Current circuit
- Frequency: 45~65Hz

### RS-485 Interface

- Address: 1 ~ FF (16 HEX)
- Baud rate: 19200,9600,4800,2400,1200
- Protocol: Modbus RTU

### DI input

- Digital input: 2 point
- State of Digital Inputs available via RS-485 Modbus, see page 14.

### DO output (Optional)

- 2 channel relay output
- Contact Capacity:
  - AC 250V, 1A resistive load
  - DC 30V, 2A resistive load

## General Features

- Display of all electric parameters: V, A, W, Var,VA, PF, Hz, WH, VarH etc.
- True RMS conversion.
- Field programmable PT and CT ratio.
- Memory for all setup and energy data.
- 2 channels digital input
- 2 channels Relay output.

### Power Meter

Measurement	Items
V <sub>L-N</sub>	V1, V2, V3, V <sub>E</sub>
V <sub>L-L</sub>	V12, V23, V13, V <sub>E</sub>
A	A1, A2, A3, A <sub>E</sub>
W	W1, W2, W3, ΣW
Var	Var1, Var2, Var3, ΣVar
VA	VA1, VA2, VA3, ΣVA
PF	PF1, PF2, PF3, ΣPF
Hz	
WH	ΣWH
VarH	ΣVarH
Demand W	DW, Max.DW (1~60min free setting)
RS-485	

### Programmable Measurement & Indication

Items	L1	L2	L3	Total	Average	Accuracy (F.S)	Display (Max.)
V <sub>L-N</sub>	V1	V2	V3		V <sub>E</sub>	± 0.25%	9999V / KV
V <sub>L-L</sub>	V12	V23	V13		A <sub>E</sub>	± 0.25%	9999A / KA
A	A1	A2	A3			± 0.5%	±9999W / KW / MW
W	W1	W2	W3	ΣW		± 0.5%	±9999Var / KVar / MVar
Var	Var1	Var2	Var3	ΣVar		± 0.5%	± 9999VA / KVA / MVA
VA	VA1	VA2	VA3	ΣVA		± 0.5%	±0.999
PF	PF1	FP2	FP3	ΣPF		± 0.1%	45.0 ~ 65.0 Hz
Hz						± 0.5%	9999999999 KWH
WH				WH		± 0.5%	9999999999 KVarH
VarH				VarH			
Accuracy performance range				Measurement range			
V: 10 ~ 100 %		PF: 0.5 ~ ±1.0		V: 10 ~ 120 %		A: 5 ~ 120 %	
A: 5 ~ 100 %		Hz: 45 ~ 65 Hz					

$$V_E = (V_{12} + V_{23} + V_{13}) / 3$$

$$\Sigma PF = \Sigma W / [V_1 A_1 + V_2 A_2 + V_3 A_3]$$

$$A_E = (A_1 + A_2 + A_3) / 3$$

$$\Sigma VAR = \sqrt{VA^2 - W^2} + \sqrt{VA^2 - W^2} + \sqrt{VA^2 - W^2}$$

$$\Sigma W = W_1 + W_2 + W_3$$

## ■ General Information

The CPW-503 is a micro processor based power meter with a 16 bit microcontroller and equipped with full-digitized measuring , indicating, calibrating and output functions. With its high speed clock (18MHz ) and sampling , CPW-503 provides a very high level accuracy measuring, even with a distorted signal. CPW-503 not only can take the placed of several static converters and measuring instruments ( V, W, PF, VAR, WH, VARH, HZ ) by single unit , but also have some special function such as Maximum demand measuring.

CPW-503 provides RS-485(Modbus RTU) as standard communication output.

## ■ Features

- Display of all the electric parameters V, A, W, Var, VA, PF, Hz, WH, VarH ect.
- True RMS conversion.
- Maximum demand function.
- PT and CT ratio range programmable (1~9999)
- Memory for all setup and energy data when power back from failed.
- Bezel size: 110 x 110 mm (4.33" x 4.33" )
- Option : 2 digital input (DI)  
2 relay output.(DO)

## ■ Specifications

Display : Red LED 0.4" high

Watt hour : 10 Digits (From 0.0 KWatt hour)

Var hour : 10 Digits (From 0.0 KWatt hour)

Over range indication : " o.L"

Conversion Rate : 1/sec.

Isolation : Input/Output/Power/Case

Operating Temp.0~60°C/ Below 90% R.H .

Storage Temp. : -10~70°C/ Below 80% R.H

Temp. Coefficient : ±0.1% F.S/°C

CT ,PT programmable Scale Factors : 1~9999

Communication : RS-485 (Standard), or RS-232

Power Supply : AC 90~260V/DC 120~370V, 47/400Hz

Option : DC 9~36V

Power Consumption : Approx. 7VA

Housing Material : ABS Flame resistant resin

Dielectric Strength : DIN-IEC688, AC 2.3KV/1min , between terminal.

AC 2.8KV/1m in, between terminal and case

## ■ Input

**Voltage** : V1, V2, V3, Neutral (These are the 3phase Voltage and neutral)

**Range** : 600VL-L / 347L-N

**Current** : 1S, 1L, 2S, 2L, 3S, 3L (These are the 3phase currents )

**Range** : 0~1A, 0~5A

**Over load** : Voltage.....750V continuous      1.25×rated continuous

Current.....3×rated continuous      10×rated for 10sec.

**Burden** : ≦ 0.2VA per Voltage circuit

≦0.2VA per Current circuit

**Frequency** : 45~65Hz

## ■ RS-485 Connection

RS-485 communications allows multiple devices to be connected on the same bus. Up to 30 devices can be connected on a single RS-485 bus, which consists of a shield twisted pair cable. The overall length of the RS-485 cable connecting all devices cannot exceed 4000ft (1219m).

Address : 1 ~ 255

Baudrate : 19200,9600,4800,2400,1200

Protocol : Modbus RTU Mode

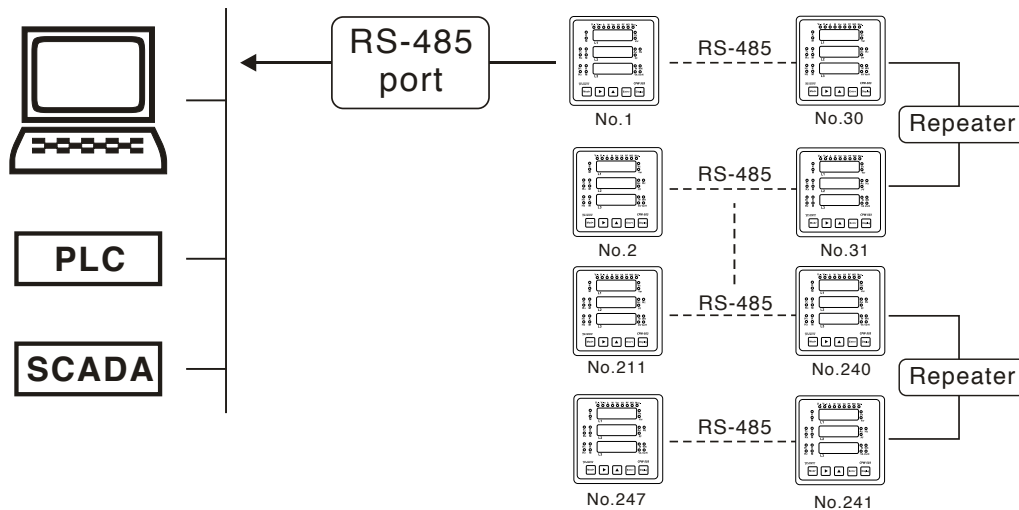

## ■ OPTION

### 1. 2 Relay output (DO)

Contact Capacity : AC 250V/1A resistive load, DC 30V/2A resistive load

### 2. 2 digital input (DI)

The digital input accept relay signal and output RS-485

## ■ Power Meter CPW503 series measured variable

Measurement	Items	CPW-503
<i>V<sub>L-N</sub></i>	V <sub>1</sub> , V <sub>2</sub> , V <sub>3</sub> , V <sub>E</sub>	●
<i>V<sub>L-L</sub></i>	V <sub>12</sub> , V <sub>23</sub> , V <sub>13</sub> , V <sub>E</sub>	●
<i>A</i>	A <sub>1</sub> , A <sub>2</sub> , A <sub>3</sub> , A <sub>E</sub>	●
<i>W</i>	W <sub>1</sub> , W <sub>2</sub> , W <sub>3</sub> , ΣW	●
<i>Var</i>	Var <sub>1</sub> , Var <sub>2</sub> , Var <sub>3</sub> , ΣVar	●
<i>VA</i>	VA <sub>1</sub> , VA <sub>2</sub> , VA <sub>3</sub> , ΣVA	●
<i>PF</i>	PF <sub>1</sub> , PF <sub>2</sub> , PF <sub>3</sub> , ΣPF	●
<i>Hz</i>		●
<i>WH</i>	ΣWH	●
<i>VarH</i>	ΣVarH	●
<i>RS-485</i>		●

## ■ Programmable Measurement & Indicating

Items	L1	L2	L3	Total	Average	Accuracy (F.S)	Display (Max.)
<i>V<sub>L-N</sub></i>	V <sub>1</sub>	V <sub>2</sub>	V <sub>3</sub>		V <sub>E</sub>	±0.25%	9999V/KV
<i>V<sub>L-L</sub></i>	V <sub>12</sub>	V <sub>23</sub>	V <sub>13</sub>				
<i>A</i>	A <sub>1</sub>	A <sub>2</sub>	A <sub>3</sub>		A <sub>E</sub>	±0.25%	9999A/KA
<i>W</i>	W <sub>1</sub>	W <sub>2</sub>	W <sub>3</sub>	ΣW		±0.5%	±9999W/KW/MW
<i>Var</i>	Var <sub>1</sub>	Var <sub>2</sub>	Var <sub>3</sub>	ΣVar		±0.5%	±9999Var/KVar/MVar
<i>VA</i>	VA <sub>1</sub>	VA <sub>2</sub>	VA <sub>3</sub>	ΣVA		±0.5%	9999V A/KVA/MVA
<i>PF</i>	PF <sub>1</sub>	PF <sub>2</sub>	PF <sub>3</sub>	ΣPF		±0.5%	±0.999
<i>WH</i>				WH		±0.5%	9999999999WH/KWH/MWH
<i>VarH</i>				VarH		±0.5%	9999999999VarH/KVarH/MVarH
<i>Hz</i>						±0.1%	45.0~65.0Hz
<b>Accuracy performance range</b>				<b>Measurement range</b>			
V : 10~100%		PF : 0.5~±1.0		V : 0~120%			
A : 5~100%		Hz : 45~65Hz		A : 0~120%			

$$V_E = (V_{12} + V_{23} + V_{13}) / 3$$

$$A_E = (A_1 + A_2 + A_3) / 3$$

$$\Sigma W = W_1 + W_2 + W_3$$

$$\Sigma PF = \Sigma W / [V_1 A_1 + V_2 A_2 + V_3 A_3]$$

$$\Sigma VAR = \sqrt{VA_1^2 - W_1^2} + \sqrt{VA_2^2 - W_2^2} + \sqrt{VA_3^2 - W_3^2}$$

## ■ Writing diagrams of input

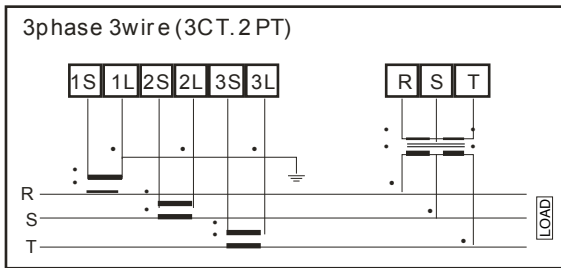
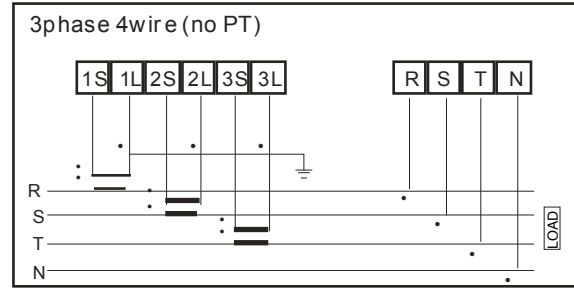
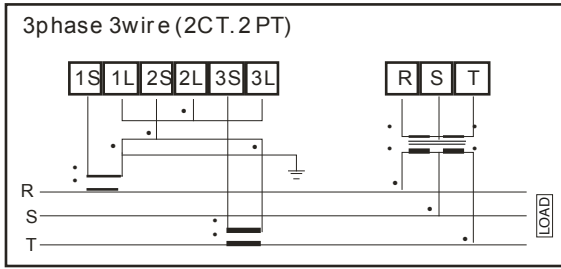

## ■ Connection Diagram (rear)

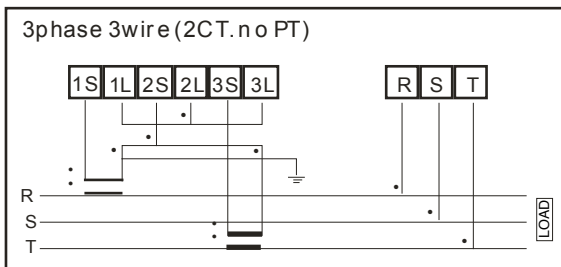
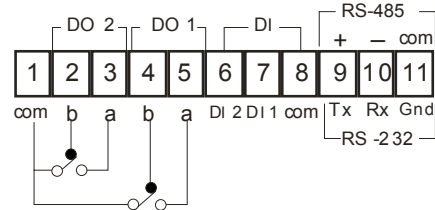
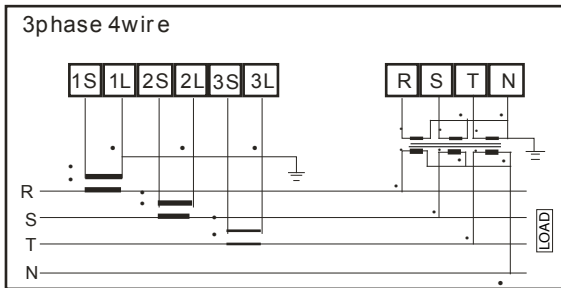
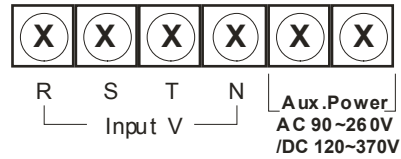
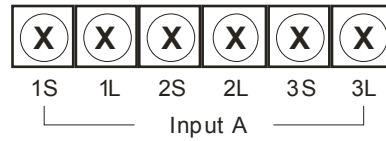

## ■ Dimensions

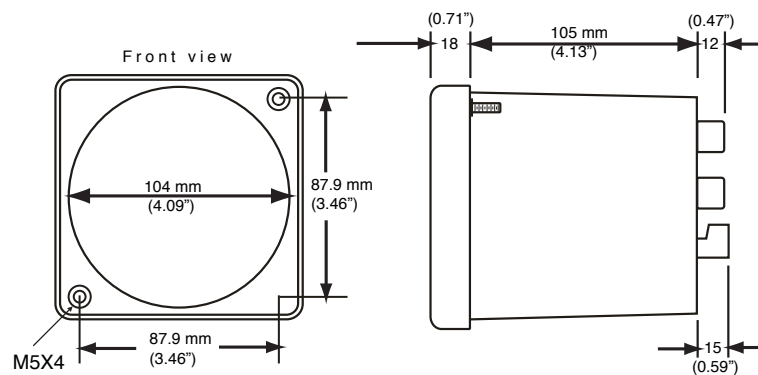

## ■ Front Panel indicators

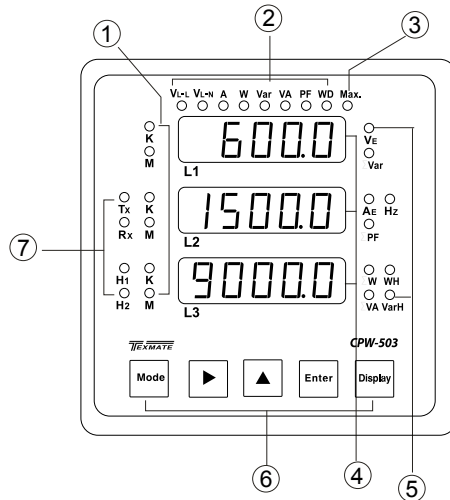

- ① Indicators of  $10^3$  times (K),  $10^6$  times (M)  
 K, M : When the LED ON the display value should be multiplied by  $10^3$  or  $10^6$   
 K, M Auto select by depend on CT PT input value
- ② Indicators of measuring units, Line Voltage(V<sub>L-L</sub>), Phase voltage, current(A), Watt(W), Reactive power(Var)  
 Apparent power (VA), Power factor(PF), Demand(DW).
- ③ Indicators of view Max. Measuring (V<sub>LL</sub>, V<sub>L-N</sub>, V<sub>E</sub>, A, W, Var, AE, ΣW)  
 The meter can retain Max information and recall this on the front panel
- ④ Display to measuring R, S, T phase value
- ⑤ Indicators of measuring unit
- ⑥ Function key
- Mode** : Mode key, into function code
- ▶** Shift key, Press it to next digit for setting  $10^3 \rightarrow 10^2 \rightarrow 10^1 \rightarrow 10^0$  cycle
- ▲** : Up key, select 0~9
- Enter** : Save key or clean key
- Display** : Allows to switch the display by sequence for view the parameters  
 : VL-L(V<sub>12</sub>, V<sub>23</sub>, V<sub>13</sub>) → VL-N(V<sub>1</sub>, V<sub>2</sub>, V<sub>3</sub>) → A(A<sub>1</sub>, A<sub>2</sub>, A<sub>3</sub>) →  
 W(W<sub>1</sub>, W<sub>2</sub>, W<sub>3</sub>) → Var(Var<sub>1</sub>, Var<sub>2</sub>, Var<sub>3</sub>) → VA(VA<sub>1</sub>, VA<sub>2</sub>, VA<sub>3</sub>)  
 → PF(PF<sub>1</sub>, PF<sub>2</sub>, PF<sub>3</sub>) → WD → V<sub>E</sub>, A<sub>E</sub>, ΣW → ΣVar, ΣPF, ΣVA  
 → Hz → KWH → KVarH
- ▶** + **Enter** Press both key at same time for view max. and turn off the max.
- ⑦ Tx, Rx indicator: The Tx and Rx LED will flash when the communication between meter and computer.
- H1, H2 indicator : Relay action LED will turn on when the corresponding relay was triggered.

## ■ Electric parameters setting process

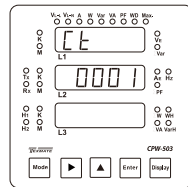
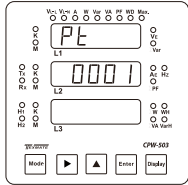
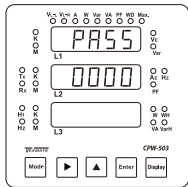

KEYS	DISPLAY	Description
Mode	PASS 0000	<b>Set password (Factor Preset 1000)</b>
▶	PASS 0000	Press shift key for 2 times the first digit flashing then
▲	PASS 0000	Press up key to select the number for 0→1→2 ..... 8→9 by cycling
▶	PASS 1000	then press shift key to continue next digit for setting 10 <sup>3</sup> →10 <sup>2</sup> →10 <sup>1</sup> →10 <sup>0</sup> by cycling
Enter	PASS 1000	Save (password:1000) then get into PT setting
Mode	Pt 0001	<b>Set PT ratio( Primary/secondary= ratio)</b> example:PT 11400V: 120VAC, the Ratio is 95
▶	Pt 0001	Press shift key for 2 times the first digit flashing then
▲	Pt 0001	Press up key to select the number for 0→1→2 ..... 8→9 by cycling
▶	Pt 0091	then press shift key to continue next digit for setting 10 <sup>3</sup> →10 <sup>2</sup> →10 <sup>1</sup> →10 <sup>0</sup> by cycling
Enter	Pt 95	Save PT ratio
Mode	Ct 0001	<b>Set CT ratio ( Primary/secondary= ratio)</b> example:CT 3000A: 5AAC, the CT Ratio is 600
▶	Ct 0001	Press shift key for 2 times the first digit flashing then
▲	Ct 0001	Press up key to select the number for 0→1→2 ..... 8→9 by cycling
▶	Ct 0601	then press shift key to continue next digit for setting 10 <sup>3</sup> →10 <sup>2</sup> →10 <sup>1</sup> →10 <sup>0</sup> by cycling
Enter	Ct 0600	Save CT ratio

KEYS	DISPLAY	Description
------	---------	-------------

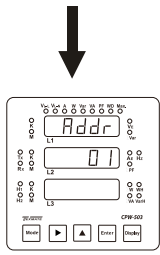

KEYS	DISPLAY
Mode	Addr
▶	Addr
	01
▲	Addr
	01
Enter	Addr
	01

### Set Address (Hex 01 ~FF)

Press Shift key to continue for next digit, digit flashing  $10^1 \rightarrow 10^0$

Press Up key to continue for Address selection by sequency  
 $0 \rightarrow 9 \rightarrow A \rightarrow B \rightarrow C \rightarrow D \rightarrow E \rightarrow F$  on flashing digit.

Save

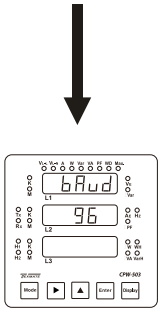

KEYS	DISPLAY
Mode	bAud
▶	bAud
	192
▲	bAud
	96
Enter	bAud
	1152

### Set Baud rate

Press Shift key to display the first Baud rate 96 (9600)

Press Up key to select Baud rate by sequency.  
 $2400 \rightarrow 4800 \rightarrow 9600 \rightarrow 19200$

Save

Baud rate table
96=9600
48=4800
24=2400
1152=11520
576=57600
384=38400
192=19200

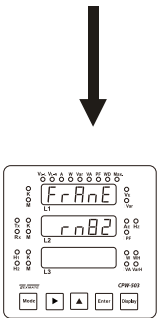

KEYS	DISPLAY
Mode	FrAnE
▶	FrAnE
	r.n.8.2
▲	FrAnE
	r.n.8.2
Enter	FrAnE
	r.n.8.2

### Set Frame

Press Shift key to display the first Frame table of r.n.8.2 (n82)

Press Up key to select Frame by sequency  
 $r.n.8.1 \rightarrow r.n.8.2 \rightarrow r.O.8.1 \rightarrow r.E.8.1$

Save

Frame table
n82=r.n.8.2
E81=r.E.8.1
O81=r.O.8.1
n81=r.n.8.1

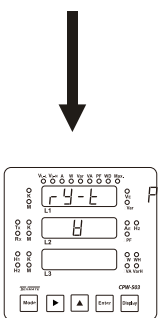

KEYS	DISPLAY
Mode	rY-tP
▶	rY-tP
	A
▲	rY-tP
	u
Enter	rY-tP
	H

### Relay output type selection

Press shift key for two times second display light on,

Then press up key to select the relay output type  
 $A \rightarrow u \rightarrow H \rightarrow Hd$

Save



**KEYS**                      **DISP LAY**                      **Description**

Mode

**Set Relay 2 setpoint value**

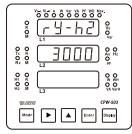

r4-h2  
\_\_\_\_\_

Press shift key for 2 times the first digit flashing then



r4-h2  
3000

Presses up key to select the number for  
0→1→2 ..... 8→9 by cycling

Enter

r4-h2  
3000

then press shift key to continue next digit for setting  
10<sup>0</sup>→10<sup>2</sup>→10<sup>1</sup>→10<sup>0</sup> by cycling

r4-h2  
3000

Press the Enter key to save setting

Mode

**Set Relay 1 setpoint value**

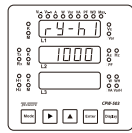

r4-h1  
\_\_\_\_\_

Press shift key for 2 times the first digit flashing then



r4-h1  
3000

Presses up key to select the number for  
0→1→2 ..... 8→9 by cycling

Enter

r4-h1  
1000

then press shift key to continue next digit for setting  
10<sup>0</sup>→10<sup>2</sup>→10<sup>1</sup>→10<sup>0</sup> by cycling

Press the Enter key to save setting

Mode

**Set WH and VarH Rest password**

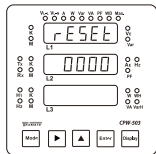

rESEET  
\_\_\_\_\_

Press shift key for 2 times the first digit flashing then



rESEET  
1000

Presses up key to select the number for  
0→1→2 ..... 8→9

Enter

rESEET  
1000

Press Up key to select number for set password by sequency  
0→1→2 ..... 8→9 on the flashing digit.

WH and VarH Reset password ( Factory set 1000)

Save

0000  
0000  
0000

Setting WH and VarH Reset password



When press enter password 1000 the WH and VarH will automatic reset to 0

**Return to normal display**



### Reading the Registers (Function code=03 Hex)

Query :

Start of frame	Address field	Function code	Start address	Number of	Error check	End of frame
----------------	---------------	---------------	---------------	-----------	-------------	--------------

Start of frame : Starting message marker

Addressfield: Address to be read (1 byte)

Function code:03Hex (1 byte)

Start address :The address of the 1 ST register (2 byte)

Number of registers:Number of word to be read

Error check:16 bit CRC

End of frame:End message marker

Response :

Start of frame	Address field	Function code	Number of data byte count	D0, D1.. Dn	Error check	End of frame
----------------	---------------	---------------	---------------------------	-------------	-------------	--------------

Start of frame : Starting message marker

Address field:Response Transducer address (1 byte)

Function code:03Hex (1 byte)

Number of data byte count: 00~?? Hex (1 byte) The number of D0~Dn

D0~Dn : Data

Error check: CRC

End of frame: End message marker

### Error message

Transducer response :

Start of frame	Address field	Function code	Error code	Error check	End of frame
----------------	---------------	---------------	------------	-------------	--------------

Start of frame: Starting message marker

Address field: Transducer address

Function code: PC response of the function code of query to 1

Error check: CRC

End of frame: End message marker

Error code: 01: Function error 02: Data address error 03: Data value error

## Modbus RTU Mode

Register Number	Register Name	Type	Saved	Scale	Units	Range	Register Description
1000	Σ voltage	R	N	V	V/ (Scale Factor V)	0 ~ 32767	
1001	Σ current	R	N	A	mA/ (Scale Factor A)	0 ~ 32767	
1002	Σ watt	R	N	E	W/ (Scale Factor E)	0 ~ +/-32767	
1003	Σ var	R	N	E	Var/ (Scale Factor E)	0 ~ +/-32767	
1004	Σ VA	R	N	E	VA/ (Scale Factor E)	0 ~ 32767	
1005	Σ PF	R	N	N	COSθ	0 ~ +/-1000	
1006	Frequency	R	N	N	0.01Hz	0 ~ 6600	
1007	Σ watt hour	R	Y	H	WH :	0 ~ 4294967295	
1008	Σ watt hour	R	Y	H	(1008) × 65536 <sup>2</sup> (1009)	0 ~ 4294967295	
1009	Σ watt hour	R	Y	H	× 65536+ (1010)	0 ~ 4294967295	
1010	Σ watt hour	R	Y	H		0 ~ 4294967295	
1011	Σ var hour	R	Y	H	VarH :	0 ~ 4294967295	
1012	Σ var hour	R	Y	H	(1012) × 65536 <sup>2</sup> (1013)	0 ~ 4294967295	
1013	Σ var hour	R	Y	H	× 65536+ (1014)	0 ~ 4294967295	
1014	Σ var hour	R	Y	H		0 ~ 4294967295	
1016	V (R-S) volatge	R	N	V	V/ (Scale Factor V)	0 ~ 32767	
1017	V (S-T) volatge	R	N	V	V/ (Scale Factor V)	0 ~ 32767	
1018	V (T-R) volatge	R	N	V	V/ (Scale Factor V)	0 ~ 32767	
1019	V (R-N) volatge	R	N	V	V/ (Scale Factor V)	0 ~ 32767	
1020	V (S-N) volatge	R	N	V	V/ (Scale Factor V)	0 ~ 32767	
1021	V (T-N) volatge	R	N	V	V/ (Scale Factor V)	0 ~ 32767	
1022	I (R) current	R	N	A	mA/ (Scale Factor A)	0 ~ 32767	
1023	I (S) current	R	N	A	mA/ (Scale Factor A)	0 ~ 32767	
1024	I (T) current	R	N	A	mA/ (Scale Factor A)	0 ~ 32767	
1025	Neutral current	R	N	A	mA/ (Scale Factor A)	0 ~ 32767	
1026	W (R)	R	N	E	W/ (Scale Factor E)	0 ~ +/-32767	Real power , Phase R
1027	W (S)	R	N	E	W/ (Scale Factor E)	0 ~ +/-32767	Real power , Phase S
1028	W (T)	R	N	E	W/ (Scale Factor E)	0 ~ +/-32767	Real power , Phase T
1029	Var (R)	R	N	E	Var/ (Scale Factor E)	0 ~ +/-32767	Reactive power , Phase R
1030	Var (S)	R	N	E	Var/ (Scale Factor E)	0 ~ +/-32767	Reactive power , Phase S
1031	Var (T)	R	N	E	Var/ (Scale Factor E)	0 ~ +/-32767	Reactive power , Phase T
1032	VA (R)	R	N	E	VA/ (Scale Factor E)	0 ~ 32767	Apparent power , Phase R
1033	VA (S)	R	N	E	VA/ (Scale Factor E)	0 ~ 32767	Apparent power , Phase S
1034	VA (T)	R	N	E	VA/ (S Scale Factor E)	0 ~ 32767	Apparent power , Phase T
1035	PF (R)	R	N	N	COSθ	0 ~ +/-1000	Power factor , Phase R
1036	PF (S)	R	N	N	COSθ	0 ~ +/-1000	Power factor , Phase S
1037	PF (T)	R	N	N	COSθ	0 ~ +/-1000	Power factor , Phase T
1038	Relay status	R	N	N	-----	0 to 3	Bit0 : Relay H1 Bit1 : Relay H2
1039	Digital inputt (option)	R	N	N	-----	0 to 3	Bit0 : Digital input 1 Bit1 : Digital input 2
1015	ΣDemand watt	R	Y	E	DW/ (Scale Factor E)	0~ +/-32767	
1042	-Σ Watt hour	R	Y	H	-WH : (1043) × 65536 <sup>2</sup> +(1044) ×65536+(1045)	0~ -4294967295	
1043							
1044							
1045							

### Modbus RTU Mode (Maximum)

Register Number	Register Name	Type	Saved	Scale	Unit	Range	Register Description
1050	Maximum $\Sigma$ voltage	R	N	V	V/ (Scale Factor V)	0 ~ 32767	
1051	Maximum $\Sigma$ current	R	N	A	mA/ (Scale Factor A)	0 ~ 32767	
1052	Maximum $\Sigma$ watt	R	N	E	W/ (Scale Factor E)	0 ~ +/- 32767	
1053	Maximum $\Sigma$ var	R	N	E	Var/ (Scale Factor E)	0 ~ +/- 32767	
1054	Maximum $\Sigma$ VA	R	N	E	VA/ (Scale Factor E)	0 ~ 32767	
1055	Maximum $\Sigma$ PF	R	N	N	COS $\theta$	0 ~ +/- 1000	
1056	Maximum Frequency	R	N	N	0.01 Hz	0 ~ 6600	
1058	Maximum V (R-S)voltage	R	N	V	V/ (Scale Factor V)	0 ~ 32767	
1059	Maximum V (S-T)voltage	R	N	V	V/ (Scale Factor V)	0 ~ 32767	
1060	Maximum V (T-R)voltage	R	N	V	V/ (Scale Factor V)	0 ~ 32767	
1061	Maximum V (R-N)voltage	R	N	V	V/ (Scale Factor V)	0 ~ 32767	
1062	Maximum V (S-N)voltage	R	N	V	V/ (Scale Factor V)	0 ~ 32767	
1063	Maximum V (T-N)voltage	R	N	V	V/ (Scale Factor V)	0 ~ 32767	
1064	Maximum I (R) current	R	N	A	mA/ (Scale Factor A)	0 ~ 32767	
1065	Maximum I (S) current	R	N	A	mA/ (Scale Factor A)	0 ~ 32767	
1066	Maximum I (T) current	R	N	A	mA/ (Scale Factor A)	0 ~ 32767	
1067	Maximum Ne utral current	R	N	A	mA/ (Scale Factor A)	0 ~ 32767	
1068	Maximum W (R)	R	N	E	W/ (Scale Factor E)	0 ~ +/- 32767	Real power , Phase R
1069	Maximum W (S)	R	N	E	W/ (Scale Factor E)	0 ~ +/- 32767	Real power , Phase S
1070	Maximum W (T)	R	N	E	W/ (Scale Factor E)	0 ~ +/- 32767	Real power , Phase T
1071	Maximum Var (R)	R	N	E	Var/ (Scale Factor E)	0 ~ +/- 32767	Reactive power , Phase R
1072	Maximum Var (S)	R	N	E	Var/ (Scale Factor E)	0 ~ +/- 32767	Reactive power , Phase S
1073	Maximum Var (T)	R	N	E	Var/ (Scale Factor E)	0 ~ +/- 32767	Reactive power , Phase T
1074	Maximum VA (R)	R	N	E	VA/ (Scale Factor E)	0 ~ 32767	Apparent power , Phase R
1075	Maximum VA (S)	R	N	E	VA/ (Scale Factor E)	0 ~ 32767	Apparent power , Phase S
1076	Maximum VA (T)	R	N	E	VA/ (Scale Factor E)	0 ~ 32767	Apparent power , Phase T
1077	Maximum PF (R)	R	N	N	COS $\theta$	0 ~ +/- 1000	Power factor, Phase R
1078	Maximum PF (S)	R	N	N	COS $\theta$	0 ~ +/- 1000	Power factor , Phase R
1079	Maximum PF (T)	R	N	N	COS $\theta$	0 ~ +/- 1000	Power factorr , Phase S
1057	Maximum Demand W	R	N	E	DW/ (Scale Factor E)	0 ~ +/- 32767	not availabe in CPW-503

### Modbus RTU Mode (Configuration)

Register Number	Register Name	Type	Saved	Scale	Unit	Range	Register Description
2000	Voltage Scale Factor V	R	N	N	-----	-2 to 1	-2 : Scale by 0.01 -1 : Scale by 0.1 0 : Scale by 1 1 : Scale by 10
2001	Current Scale Factor A	R	N	N	-----	-4 to 0	-4 : Scale by 0.0001 -3 : Scale by 0.001 -2 : Scale by 0.01 -1 : Scale by 0.1 0 : Scale by 1
2002	Watt,Var,VA,Scale Factor E	R	N	N	-----	-7 to 1	-7 : Scale by 0.0000001 -6 : Scale by 0.000001 -5 : Scale by 0.00001 -4 : Scale by 0.0001 -3 : Scale by 0.001 -2 : Scale by 0.01 -1 : Scale by 0.1 0 : Scale by 1 1 : Scale by 10
2003	Reversed	R	N	N	-----	0	
2004	PT	R/W	Y	N	-----	1 ~ 9999	Voltage Ratio
2005	CT	R/W	Y	N	-----	1 ~ 9999	Current Ratio
2006	Power Demand interval	R/W	Y	N	Minute	1 ~ 60	Demand interval
2007	Relay type	R/W	Y	N	-----	0 to 2	0 : $\Sigma$ voltage 1 : $\Sigma$ current 2 : $\Sigma$ watt
2008	Relay Hi set2 value	R/W	Y	N	-----	0~ 9999	Relay Hi set 2 value
2009	Relay Lo set value	R/W	Y	N	-----	0 ~ 9999	Relay Lo set1 value
2010	Reset Maximum value	W	N	N	-----	0 to 1	1: reset Other: illegal
2011	Reset Maximum Demand	W	N	N	-----	0 to 1	1: reset Other: illegal
2012	Reset Energy value	W	N	N	-----	0 to 1	1: reset Other: illegal

## Ordering Information

### Standard Options for this Model Number

Part Number	Description	List
-------------	-------------	------

#### ►BASIC MODEL NUMBER

Includes standard display, standard power supply and RS-485 with 2 digital Inputs unless optional versions are ordered.

CPW-503..... 3 Phase Power Meter Three 0.4" RED LED

#### ►POWER SUPPLY

PS1 . . 85-264VAC/120-370VDC . . . . .  
PS4 . DC 24V . . . . .

#### ►INPUT (600V L-L / 347V L-N FOR VOLTAGE)

AC5. AC 0.5~5A . . . . .  
AC1. AC 0.05~1A . . . . .  
ACY. Custom Option . . . . .

#### ►RELAY (OPTIONAL)

RC2. Two Form C 1A . . . . .

#### WARRANTY

Texmate warrants that its products are free from defects in material and workmanship under normal use and service for a period of one year from date of shipment. Texmate's obligations under this warranty are limited to replacement or repair, at its option, at its factory, of any of the products which shall, within the applicable period after shipment, be returned to Texmate's facility, transportation charges pre-paid, and which are, after examination, disclosed to the satisfaction of Texmate to be thus defective. The warranty shall not apply to any equipment which shall have been repaired or altered, except by Texmate, or which shall have been subjected to misuse, negligence, or accident. In no case shall Texmate's liability exceed the original purchase price. The aforementioned provisions do not extend the original warranty period of any product which has been either repaired or replaced by Texmate.

#### USER'S RESPONSIBILITY

We are pleased to offer suggestions on the use of our various products either by way of printed matter or through direct contact with our sales/application engineering staff. However, since we have no control over the use of our products once they are shipped, NO WARRANTY WHETHER OF MERCHANTABILITY, FITNESS FOR PURPOSE, OR OTHERWISE is made beyond the repair, replacement, or refund of purchase price at the sole discretion of Texmate. Users shall determine the suitability of the product for the intended application before using, and the users assume all risk and liability whatsoever in connection therewith, regardless of any of our suggestions or statements as to application or construction. In no event shall Texmate's liability, in law or otherwise, be in excess of the purchase price of the product.

Texmate cannot assume responsibility for any circuitry described. No circuit patent or software licenses are implied. Texmate reserves the right to change circuitry, operating software, specifications, and prices without notice at any time.



450 State Place • Escondido, CA 92029

Tel: 1-760-598-9899 • USA 1-800-839-6283 • That's 1-800-TEXMATE

Fax: 1-760-598-9828 • Email: orders@texmate.com • Web: www.texmate.com

For product details visit [www.texmate.com](http://www.texmate.com)

Local Distributor Address