



Center Bar for Dual Scale Applications (Tri-Color or Mono-Color)



LEOPARD FAMILY

FL-B101Q

Leopard Bargraph Meter
101 Segment LEDs
in a 9/64 DIN CASE

Smart mono-color digital bargraph with four fully programmable set points for monitoring, measurement, and control applications.



Left or Right Bar to match 6" Edgewise Mechanical Meters with Left or Right Pointers (Mono-Color only)



Input Module Compatibility

LEOPARD FAMILY: More than 38 different Plug-in I-Series Input Signal Conditioners are approved for Texmate's Leopard Family of meters. Some examples are shown on pages 12 - 16. See www.texmate.com for an up to date listing.



LEOPARD

Specifications

- Input Specs:**Depends on range and function selected
- A/D Converter:**14 bit single slope
- Accuracy:**±(0.05% of reading + 1segment)
- Temp. Coeff.:**100 ppm/°C (Typical)
- Warm up time:**2 minutes
- Conversion Rate:**10 conversions per second (Typical)
- Bargraph Display:****101 segment 4" vertical (std)**, horizontal (optn), **red (std)**, green (optn), one red one green (optn)
- Polarity:**Selectable center zero
- Positive Overrange:**..Bargraph display flashes
- Negative Overrange:** First segment of bargraph display flashes
- Relay Output:**Two 5 Amp Form A relays and Two 10 Amp Form C relays
- Analog Output:**Isolated 16 bit user scalable mA or V
 - OIC (mA out)4-20 mA @ 0 to 500Ω max loop resistance
 - OIV (volts out)0-10 V DC @ 500 Ω or higher resistance
- Power Supply:**AC/DC Auto sensing wide range supply
 - PS1 (std)85-265 VAC / 95-370 VDC @ 2.5W max 4.2W**
 - PS215-48 VAC / 10-72 VDC @ 2.5W max 4.2W
- Operating Temp.:**0 to 60°C
- Storage Temp:**-20°C to 70°C
- Relative Humidity:**95% (non condensing)
- Case Dimensions:**3/32 DIN, Bezel: 36x144 mm(1.42"x5.69")
 - Depth behind bezel: (4.64") 117.5 mm
 - Plus 10 mm (0.39") for Right-angled connector, or plus 18.3 mm (0.72") for Straight-thru connector, or plus 26.5 mm (1.05") for Push-On connector.
- Weight:**9.5 oz., 12 oz when packed

General Features

- Two 10 Amp Form C, and two 5 Amp Form A relays available
- Auto-sensing AC/DC power supply. For voltages between **85-265 V AC / 95-370 V DC (PS1)** or 15-48 V AC / 10-72 V DC (PS2).
- Optional isolated 16 bit analog output. User or factory scalable to 4 to 20 mA, 0 to 20 mA or 0 to 10 V across any desired span from ± one bar to the full scale range
- Provision to connect an external programming lockout switch.
- Optional NEMA-4 front cover.
- 24 V DC excitation is available to power external 4/20 mA transmitters and 5 or 10 V DC excitation is available for resistance bridge type sensors.

Software Features

- The two 101 segment bargraph can be independently scaled.
- Bargraph center zero function.
- Four programmable setpoints.
- Relays activation can be selected to occur above (HI) or below (LO) each setpoint.
- Decimal point setting.

Index

Analog Scaling and Calibration9	Functional Diagram10	Opening the Case to Access Mode	Standard Display Mode Calibration
Case Dimensions15	General Features1	Select Headers4	Procedure5
Center Zero Mode Scaling for Bipolar	Input Module Analog Calibration	Overview of Display Modes, Scaling	Standard Face Plate & Scales18
Inputs6-7	Procedures17	Capabilities and Operation Modes . .3	Standard Scales & Caption Sheets .18
Component Layout11	Input Module Compatibility1	Panel Adapter3	Two Point Quickset Scaling and
Connector Pinouts10	Input Module Component Glossary . .16	Pin Descriptions10	Calibration5,6
Connectors11	I-Series Input Signal Conditioning	Setpoint Adjust7-8	
Controls and Indicators2	Modules12-15	Setting the Colors8	
Glossary of Programming Symbols	One Point Quickset Rescaling and	Software Features1	
and Modes of Operation2	Calibration Procedure6	Specifications1	
Custom Face Plates & Scales19	Ordering Information20		

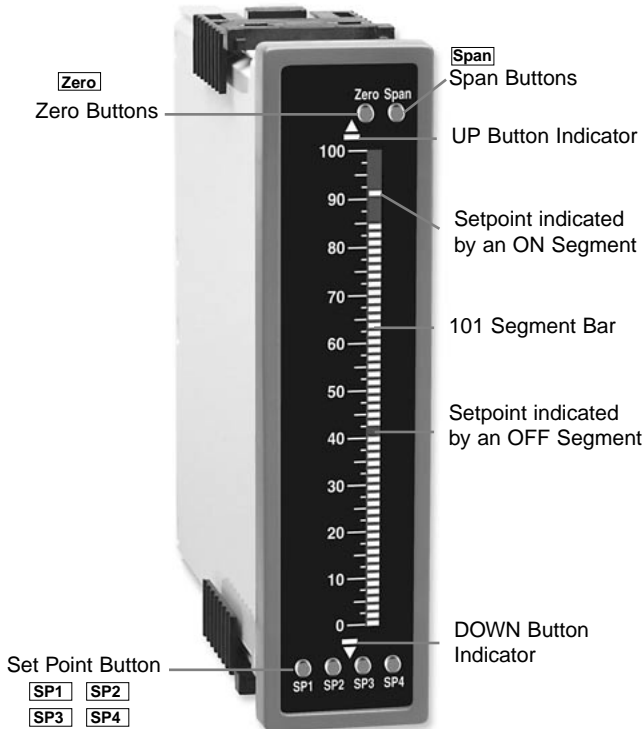

Quickset Programming

This bargraph features Texmate's unique QUICKSET PROGRAMMING. When a front panel button is pressed the associated function is directly changed. The direction of change will be either up or down, as indicated by the UP and DOWN indicator LEDs. After the indicator LED lights up there is a 0.5 second delay before any change occurs. When a button is released and pressed again the direction of change is reversed. As there are no menu or sub-menus to navigate, the programming and setup is quick and easy.

Front Panel Buttons

Zero Button

The Zero Button sets the Channel 1 low input signal scaling.

Span Button

The Span Button sets the Channel 1 high input signal scaling.

SP1, SP2, SP3 and SP4 Buttons

These buttons setup the corresponding setpoints.

Setpoint Indication

The position of setpoints on the bargraph display are indicated by an ON segment if the bargraph display is below the setpoint, and by an OFF segment if the bargraph display is above the setpoint. (See the drawing above)

Center Bar Display Option

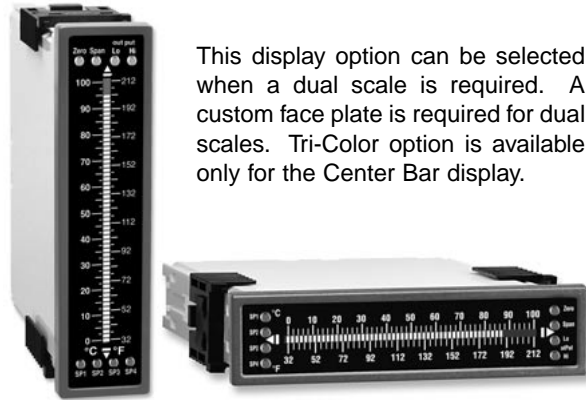

This display option can be selected when a dual scale is required. A custom face plate is required for dual scales. Tri-Color option is available only for the Center Bar display.

Glossary of Programming Symbols and Modes of Operation

To explain software programming procedures, logic diagrams are used to visually assist in following programming steps. The following symbols are used to represent the functions and displays of the meter:

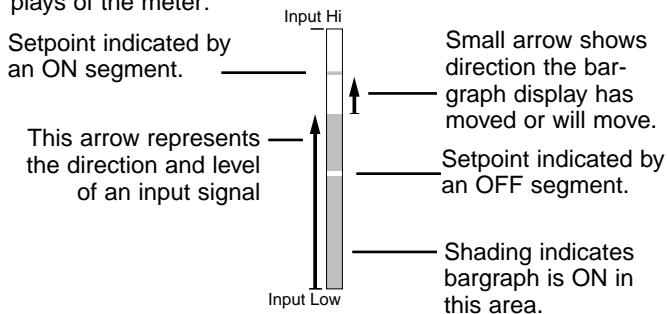

Standard or Center Zero Display Mode Select Header



•Jumper clips enables standard display on CH1 and CH2.



•Jumper clip to enable Center Zero display.

Operating Mode Select Header: This header selects one of the two basic operating modes presently available for this meter.



Mode 0 Bargraph with four set points displayed on bargraph display.



Mode 3 Enables the Hysteresis mode for tank filling or tank emptying applications.



When two fingers are shown side by side, the two corresponding buttons must be pressed at the same time to initiate an indicated function.

Relay Activation Mode Select Header



When no jumper clips are installed the relays will activate when the display exceeds the set point. Any relay that has a jumper clip installed will activate when the display is less than the set point.



Standard Display Mode

Standard Scaling

Standard display mode selected and scaled so bar increases as input signal increases from Low to Hi.

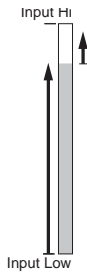

Inverse Scaling

Standard display mode selected and scaled so the bar increases as the input signal decreases from Hi to Low.

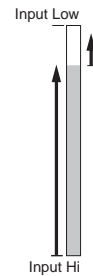

Center Zero Display Mode

Bipolar Center Zero

Center point display mode selected and scaled, so the bar increases upward from zero, for increasing positive inputs and downward from zero for increasing negative inputs. When the input is zero, only the center segment will be on.

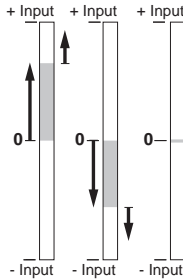

Halfway Zero Point

Center point display mode selected and scaled, so the bar increases upwards or downwards from the center point, for signals that are greater or less than half the calibrated full scale range respectively. When the input is equal to half the full scale range, only the center segment will be on.

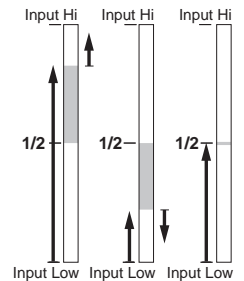

Mode 0 Channel Inputs

Display with 4 Set Points

With Standard display or Center point mode selected, the setpoints are indicated by an **ON** segment outside the bar display area and by an **OFF** segment inside the bar display area.

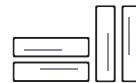
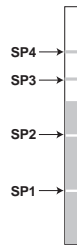

Horizontal and Reverse Mounting with Custom Face Plate Installed

Horizontal or Reverse Mounting
Meters can be mounted horizontally in the panel and for those applications that require an opposite growth of the bar, the meter can be vertically or horizontally mounted upside down

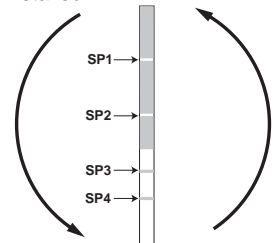

Mode 3 Hysteresis Band between SP1 & SP2

This mode enables the Hysteresis function. In order for Hysteresis to function, SP2 must be set to a value greater than SP1, and SP2 should be selected as High (h) Setpoint (See page 7). When these conditions are met, and Mode 3 is selected, then a Hysteresis band is created for the SP1 relay, with the upper limit of SP2 and the lower limit of SP1. SP2 relay continues to operate normally.

- For a tank filling application SP1 is set to a Low (L) Setpoint. SP1 relay can control a pump that fills the tank. With Mode 3 selected, SP1 relay activates for inputs less than the SP1 level. Once activated, SP1 relay will stay ON until the tank is filled to the SP2 level.

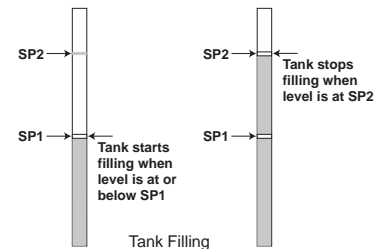

- For a tank emptying application SP1 is set to a High (h) Setpoint. SP1 can control a pump that empties the tank. With Mode 3 selected, SP1 relay activates for inputs greater than the SP2 level. Once activated, SP1 relay will stay ON until the tank is emptied to the SP1 level.

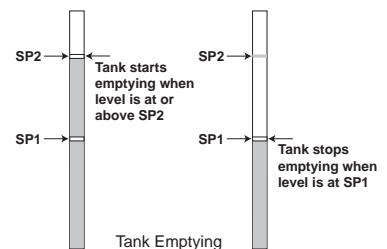

Opening the Case to Access Mode Select Headers

The mode select headers are located on the Display Driver Board assembly. To change any of the modes, it is best to remove the Display Driver Board assembly from the case. Before removing the Display Driver Board assembly from the front of the case it is necessary to remove the rear cover and slide the main board back an inch, or remove it, to disengage the pin and socket connector between the main board and the display assembly.

Step 1

Remove the front bezel by lightly levering the plastic catches up and forward in the a b c d sequence shown. Then remove the cover and scale faceplate.

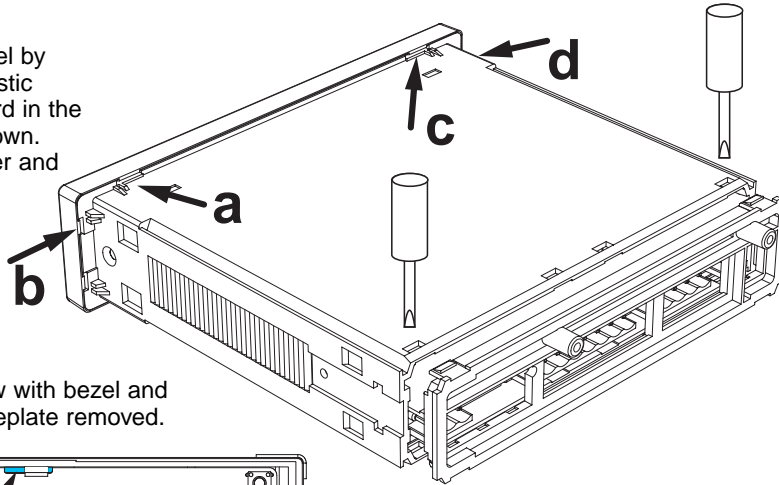

Front view with bezel and scale faceplate removed.

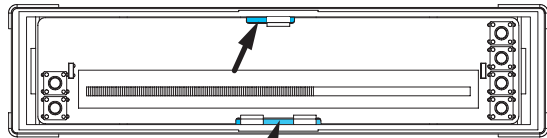

Step 2

Remove the rear cover plate by pressing down lightly with a small flat bladed screw driver to release two plastic catches, on either side of the case and levering backwards.

Step 3

Slide the Main Board back approximately 1" to disengage the pin and socket connection to the Display Driver Board.

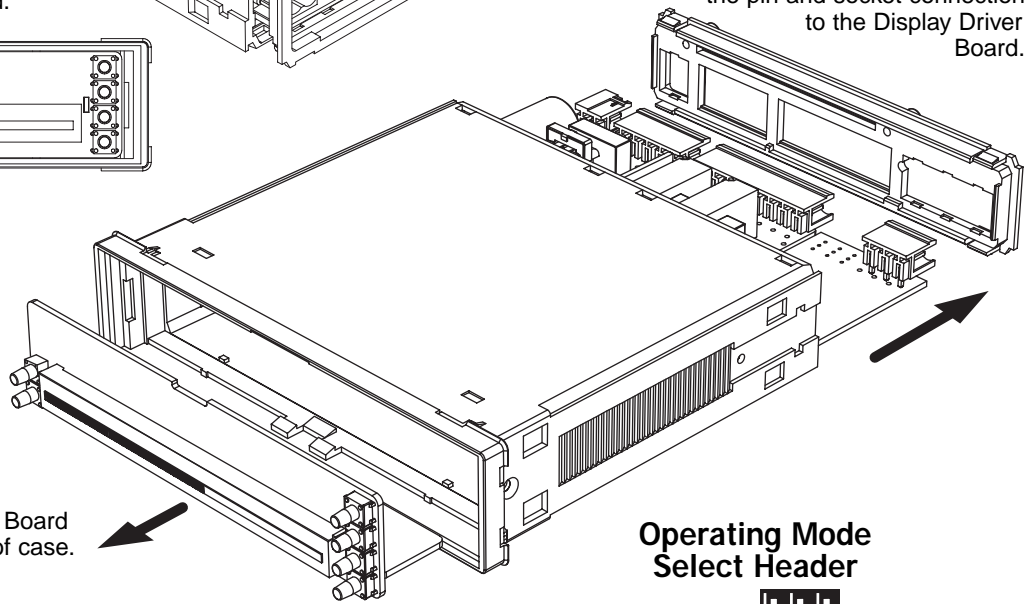

Step 4

Starting with the top first, insert a small flat bladed screw driver and carefully lever the plastic catch up and tilt the Display Board assembly forward. Then repeat this action with the bottom catches.

Step 5

Remove the entire Display Board assembly by sliding it out of case.

Operating Mode Select Header



Standard or Center Zero Display Mode Select Header

Display Mode Select Header



Relay Activation Mode Select Header

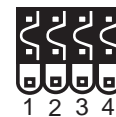

Meter Exploded view

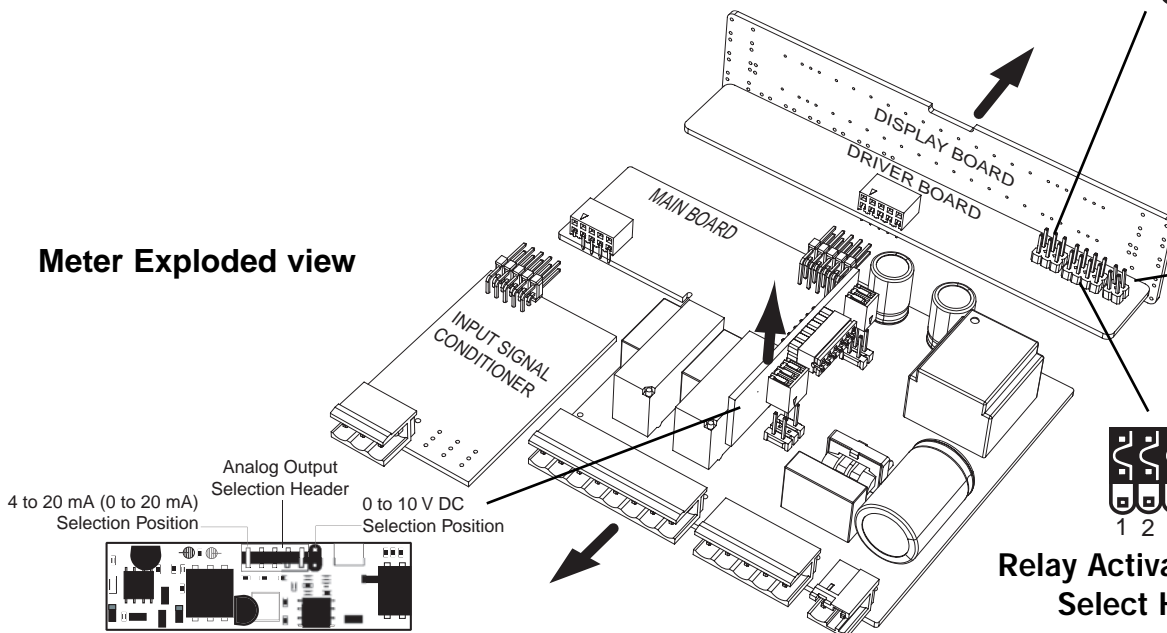

4 to 20 mA (0 to 20 mA) Selection Position
 Analog Output Selection Header
 0 to 10 V DC Selection Position

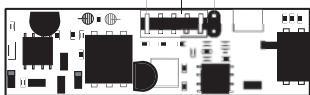

Optional 16 Bit Isolated Analog Output Module

Two Point Quickset Scaling and Calibration

Meters with **QUICKSET PROGRAMMING** feature a unique, easy-to-use, two point scaling and calibration system.

Scaling or calibration is accomplished simply, by applying a zero or low input signal and adjusting the bar to the desired reading, using the ZERO button. A higher input signal is then applied, and the bar is adjusted to the desired reading for that input value, using the SPAN button.

IMPORTANT DETAILS THAT MAKE QUICKSET PROGRAMMING EASY TO USE AND UNDERSTAND

1. The zero and span buttons are functionally the same, except as follows: The ZERO button can initiate a scaling with input signals from zero to 95% of fullscale. The Span button can initiate a scaling with input signals from 5% of fullscale to 105% of fullscale.
2. When a Zero or Span button is pressed, the Up or Down indicator LED will immediately light up to show the direction, in which the Bar will move, after a 0.5 second delay. If the button is released and pressed again, the opposite Up or Down indicator will light up, and 0.5 seconds later the Bar will begin to move in that direction until the button is released. When the bar is being adjusted to zero or fullscale, the bar will automatically stop at the zero or fullscale position, and will not overshoot these positions, even if the button continues to be pressed.
3. While the bar is being adjusted, a new offset and scale factor is continuously being calculated. At the moment the button is released, and the scaling is accepted, the calculation data is memorized and implemented. The Scaling calculation is based on the new position of the Bar, the input signal being applied at that moment, and the previously memorized position of the Bar and the input signal that was being applied, when the other button was last released.
4. Positive and negative signals maybe integrated into a two point scaling. However when either a ZERO or SPAN button is pressed the input signal being applied, must be more than 5% higher or lower than the previously memorized value of the input signal, that was being applied when the other button was last released. If not, the bar will flash, the scaling will not be accepted, and the previous scaling will still be retained in memory.
5. Because of the requirement, that a new scaling input signal must be 5% higher or lower than the previously stored value, it can sometimes be difficult to implement a desired scaling, particularly when using a calibrator that only has fixed output values. In this case Reset the Scaling by pressing the ZERO and SPAN buttons simultaneously for two seconds. Both scaling memories will be erased and an internal default scale factor will be loaded. This provides a display of zero to fullscale on the bar for an input of approximately 0 to 100% of the range selected on the input signal conditioning module. After Resetting the Scaling a new calibration, using either button, can be implemented with new input signal values. It is good practice to always use the Zero button for lower input signals and the Span button for higher input signals, even when the bar display scale is inverted.
6. The larger the difference between two points used for calibration, the better the accuracy. However if the difference is too high, and the output from the input signal conditioning module is greater than +2.1VDC, or less than -1.05VDC, the bar will flash over range. The calibration will not then be accepted and, the previous scaling will still be retained in memory. In this case, either a lower input signal must be used, or a higher range on the input module should be selected to recalibrate the meter.

Note: Most input signal conditioners have provisions for analog calibration and scaling. If the meter's scale factor is set to read zero with a zero input (shorted input), and to read 10 Bars fullscale with a 2.000 V input, any pre-calibrated signal conditioner with an output that does not exceed - 1 V to + 2 V, will read correctly in the meter without any further calibration.

Standard Display Mode Calibration Procedure



Standard Display with Jumper Clips in OFF position

Standard or Center Zero Display Mode may be selected, depending on the Operating Mode selected. If the standard display mode is not already selected open the meter case as showing on page 4 and move the jumper clips on the display mode select header to the OFF position.

STEP A REVIEW THE INPUT MODULE STATUS

- 1) See pages 15 – 21 for information on input modules that may be used with this meter.
- 2) Confirm that the correct range and input is selected on the input signal conditioning module.

Note: When undertaking an initial set up and primary scaling and calibration of the meter it is best to start with a reset of the scaling.

STEP B RESET THE SCALING

- 1) Apply power to the meter and press the ZERO and SPAN buttons simultaneously for 2 seconds. This erases any previously memorized scalings, and resets the scaling to the factory default, of approximately zero to full scale, for an input, that is 0 to 100% of the range selected on the input signal conditioner.

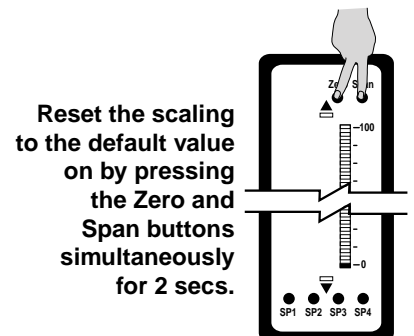

Standard Display Mode Calibration Procedure Continued

Note: To calibrate the bargraph you must be able to input two input signals. Usually the minimum input (LO Input) and the maximum input (HI Input) signals are used for optimum accuracy. However a scaling can be accomplished with any two signals that are higher or lower than each other by more than 5% of fullscale and are not greater than +2.1VDC or less than -1.05VDC.

STEP C SET THE LOW INPUT SIGNAL READING ON THE BAR

- 1) Apply the LO input signal (4ma in this example) to the input pins.
- 2) Using the ZERO button adjust the bar down to the required position.

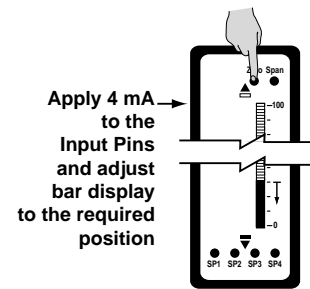

STEP D SET THE HIGH INPUT SIGNAL READING ON THE BAR

- 1) Apply the high input signal (20mA in this example) to the input pins. Using the SPAN button adjust the bar to the required position. This position could be higher or lower than the position adjusted in Step 2. The scaling for an input of 4 to 20mA is now complete.

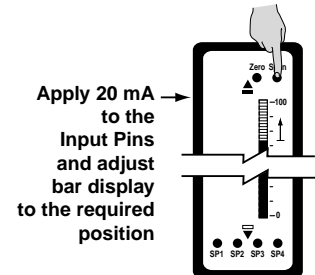

One Point Quickset Rescaling and Calibration Procedure

ONE POINT RECALIBRATION

As explained earlier, the FL-B101Q bargraph is calibrated using two point calibration. Once a bargraph is calibrated, the low end of the range may be then recalibrated without affecting the calibration of the high end, and vice versa.

For example, take an FL-B101Q that has been calibrated to read zero to full scale for an input of 4 to 20mA. If now the scaling has to be changed to read zero to full scale for an input of 0 to 20mA, only the low (4 mA) end needs to be recalibrated. The high (20 mA) end of the scaling is left untouched, and so does not change. The following one point recalibration procedure is used for this purpose.

STEP A RECALIBRATE THE LOW INPUT SIGNAL READING ON THE BAR

- 1) Apply the LO input signal (0ma in this example) to the input pins. The first segment will flash, indicating an under range condition.
- 2) Using the ZERO button adjust the bar up to the required position.
- 3) The FL-B101Q has now been recalibrated to read zero to fullscale for a 0 to 20 mA input.

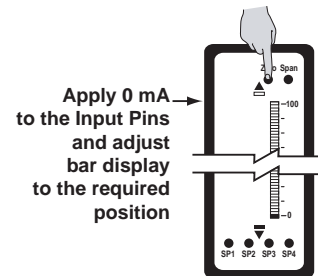

Center Zero Mode Scaling For Bipolar Inputs

The procedure for scaling the bar graph for bipolar signals is very simple. If say CH1 has to be scaled for -1V to +1V, the steps are as follows:

STEP A SELECT THE CENTER ZERO DISPLAY MODE FOR CH1

- 1) Following the instructions on page 4, remove the meter from the case.
- 2) Select the Center Zero Mode for CH1 by repositioning the jumper clip on the Center Zero Display Mode Select Header.

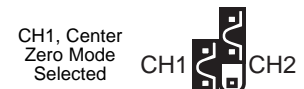

STEP B REVIEW THE INPUT MODULE STATUS

- 1) See pages 15 – 21 for information on input modules that may be use with this meter.
- 2) Only the IDP4 Universal Input module can be used for dual inputs and information on this module can be found on page 15.
- 3) Confirm that the correct range and input is selected on the input signal conditioning module.

Note: When undertaking an initial set up and primary scaling and calibration of the meter it is best to start with a reset of the scaling.

STEP C RESET THE SCALING ON CHANNEL ONE

- 1) Apply power to the meter and press the CH1 ZERO and CH1 SPAN buttons simultaneously for 2 seconds. This erases any previously memorized scalings, and resets the scaling to the factory default, of approximately zero to full scale, for an input, that is 0 to 100% of the range selected on the input signal conditioner.

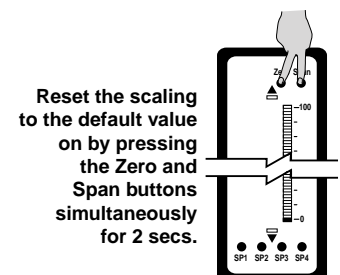

Center Zero Mode Scaling For Bipolar Inputs continued

STEP D SET THE LOW INPUT SIGNAL READING ON THE BAR

- 1) Apply the LO input signal (-1V in this example) to the CH1 input pins.
- 2) Using the CH1 ZERO button adjust the bar down to the required position. In this case, all the bar segments from mid point down to the bottom will be ON.

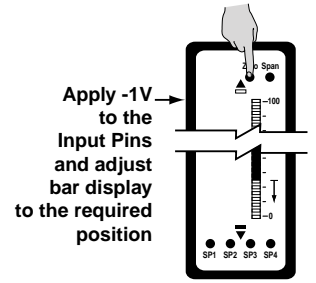

STEP E SET THE HIGH INPUT SIGNAL READING ON THE BAR

- 1) Apply the high input signal (+1V in this example) to the CH1 input pins.
- 2) Using the CH1 SPAN button adjust the bar to the required position. This position could be higher or lower than the position adjusted in Step 2. In this case, all the bar segments from mid point up to the top will be ON.
- 3) The scaling of CH1 for an input of -1V to +1V is now complete.

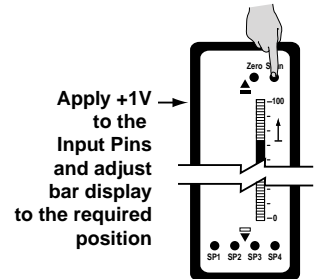

Setpoint Adjust

The bargraph has the option to have up to 4 setpoints (two 10A Form C relays and two 5A Form A relays) installed. Each relay may be set to activate either above or below its setpoint by inserting jumper clips on the Relay Activation header which is located on the Display Driver Board. See the layout diagram on Page 4 and 14 for the exact location. The steps to setup the setpoints are as follows:

1) SELECT THE RELAY ACTIVATION MODE FOR EACH INSTALLED RELAY

Make sure that the required relays have been installed in the meter. Refer to the component layout on Page 14 for relay positions. If a jumper clip is installed in a specific relay position on the Relay Activation Mode Header, that relay will activate when the display bar is lower than the programmed setpoint. If no jumper clip is installed in a specific relay position on the Relay Activation Mode Header, that relay will activate when the display bar is equal to or higher than the programmed setpoint. The Diagrams below show some of the various possibilities for relay activation.

Default

SP1, SP2, SP3, and SP4 all activate when input is equal to or higher than set point.



SP2 and SP4 activate when input is lower than set point. SP1 and SP3 activate when input is equal to or higher than set point.

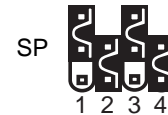

SP2 activate when input is lower than set point. SP1, SP3 and SP4 activate when input is equal to or higher than set point.



SP1 and SP3 activate when input is lower than set point. SP2 and SP4 activate when input is equal to or higher than set point.



SP1, SP2, SP3, and SP4 all activate when input is lower than set point.



SP1 and SP2 activate when input is lower than set point. SP3 and SP4 activate when input is equal to or higher than set point.



Setpoint Adjust continued

2) ADJUST THE SETPOINT FOR EACH RELAY

The setpoint for each relay is set by the front panel buttons marked SP1, SP2, SP3 and SP4. When a front panel button is pressed and held down, the associated setpoint is directly changed. The direction of change will be either up or down, as indicated by the UP and DOWN indicator LEDs. After the indicator LED lights up there is a 0.5 second delay before any change occurs. To reverse the direction of change, release the button and then press down again. As there are no menus or sub-menus to navigate, the programming and setup is quick and easy.

Setpoints are indicated on the bar display by an ON segment if the bar is below the setpoint and with an OFF segment if the bar display is above the setpoint.

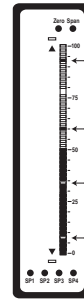

Setting the Colors (For CHT or CVT Center Bar display options only)

To comply with the latest safety requirements, the tri-color bargraph is designed like a traffic light, to display either red, orange or green, but only one color at a time. When the bar reaches a selected color change point, the entire bar will change to the color designated for that zone. This eliminates any ambiguity as to the signal status, especially just after transitioning to a new zone.

However, if two or more setpoints with differently specified colors are positioned at the same set point value, the color specified for the set point with the highest identifying number will be displayed. When set points are set to the same value, the SP4 color overrides the SP3 color, the SP3 color overrides the SP2 color, and the SP2 color overrides the SP1 color.

STEP A ENTER COLOR SET MODE

Hold down ALL four setpoint buttons (SP1, SP2, SP3 and SP4) and apply power to the meter. The meter will light up in the Color Set Mode. Release all the setpoint buttons.

STEP B SELECT COLOR FOR BAR ABOVE SETPOINT 1

Hold down the SP1 button. The color of the bar segments below SP1 will cycle between red, green and orange. Release the SP1 button when the bar is the required color. Now whenever the bar is above the SP1 level it will be this color. When the bar is below the SP1 level it will always be red.

STEP C SELECT COLOR FOR BAR ABOVE SETPOINT 2

Hold down the SP2 button. The color of the bar segments below SP2 will cycle between red, green and orange. Release the SP2 button when the bar is the required color. Now whenever the bar is above the SP2 level it will be this color.

STEP D SELECT COLOR FOR BAR ABOVE SETPOINT 3

Hold down the SP3 button. The color of the bar segments below SP3 will cycle between red, green and orange. Release the SP3 button when the bar is the required color. Now whenever the bar is above the SP3 level it will be this color.

STEP E SELECT COLOR FOR BAR ABOVE SETPOINT 4

Hold down the SP4 button. The color of the bar segments below SP4 will cycle between red, green and orange. Release the SP4 button when the bar is the required color. Now whenever the bar is above the SP4 level it will be this color.

STEP F EXIT COLOR SET MODE

Turn off the power to the meter for 5 seconds and then re apply the power. The bargraph will now work with the programmed colors.

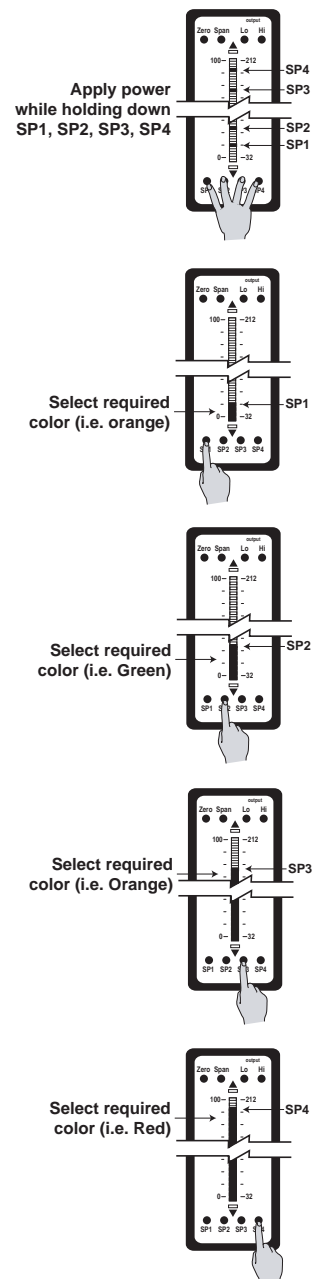

Analog Output Scaling and Calibration

When the optional analog output module is installed, an independently calibrated 16 bit isolated, voltage or current analog output is available. **The analog signal is independently scaled to the input signal and not to the bargraph display.** It is important to note that the Analog Output is completely independently of the bargraph display. This means for example that the bargraph display may be scaled to go from zero to full scale as the input changes from 0 to 5V, while at the same time, the analog output is scaled to go from 4 to 20mA as the input changes from 2 to 3V. Rescaling the bargraph or the analog output will not affect the scaling of the other.

To calibrate the Analog Output you must be able to input two input signals. Usually the minimum input (LO Input) and the maximum (HI Input) signals are used for maximum accuracy.

For example the five steps to obtain an Analog Output of 4mA to 20mA for an input of 0 to 10V are:

STEP A ACCESS THE ANALOG CALIBRATION MODE

- 1) Confirm the internal analog output module is installed and that the required voltage or current output option is selected.
- 2) Turn OFF the power to the bargraph.
- 3) Hold down the ZERO and SPAN buttons simultaneously and re-power the bargraph. The ZERO button will now function as the LO button and the SPAN button will now function as the HI button for calibrating the Analog Output.

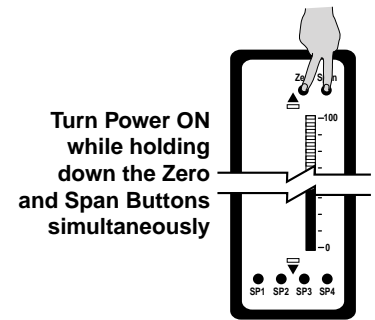

STEP B RESET THE ANALOG OUTPUT SCALING

- 1) Press the LO and HI buttons simultaneously and hold them down for 2 seconds. This will reset the analog output scaling to the default value. The default analog output scaling is approximately 0 to 20mA (0 to 10V if voltage output option is selected) for an input that is 0 to 100% of the range selected on the input signal conditioner.

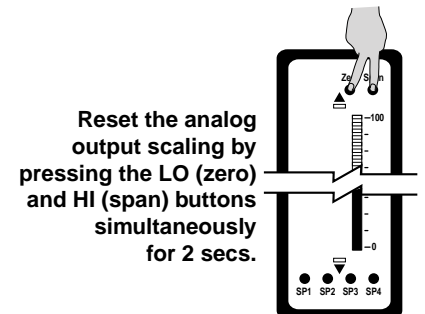

STEP C CALIBRATE ANALOG OUTPUT FOR LO SIGNAL

- 1) Apply the low input signal (0V in this example) to the meter.
- 2) Connect an external multimeter to the analog output pins (Pins 17 and 18).
- 3) Using the LO button adjust the analog output as measured on the external multimeter to be the required value. (4mA in this example). When the LO button is pressed, the UP or DOWN indicator LED shows the direction of change. To reverse the direction of change release the LO button and press down again. Initially the output changes very slowly, but speeds up as the LO button remains pressed down. The analog output for a low input can be set in this step to any value in the range of 0 to 20mA or 0 to 10V (if the voltage output option is selected).

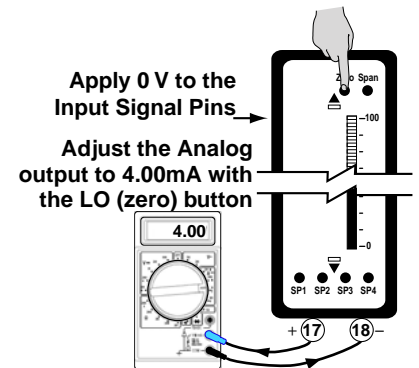

STEP D CALIBRATE ANALOG OUTPUT FOR HI SIGNAL

- 1) Next apply the high input signal (10V in this example) to the meter.
- 2) Using the HI button, adjust the analog output as measured on the external multimeter to be the required value. (20mA in this example). When the HI button is pressed the UP or DOWN indicator LED shows the direction of change. Release the HI button and press again to reverse the direction of change. Initially the output changes very slowly, but speeds up as the HI button continues to remain pressed. This output may be higher or lower than the value set in Step 2, and may be any value in the range of 0 to 20mA or 0 to 10V. This allows the easy reversal of analog output that is required in some applications.

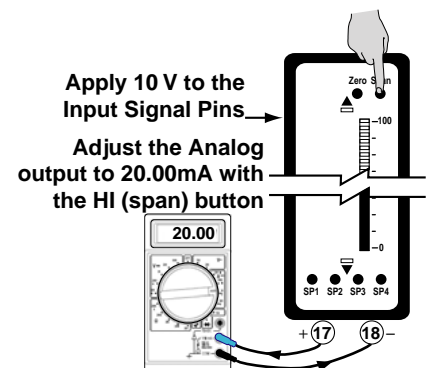

STEP E EXIT THE ANALOG OUTPUT CALIBRATION MODE

- 1) Turn OFF the power to the bargraph
- 2) Re-power the bargraph. The two buttons will now return to their original function of DISPLAY 2 ZERO and DISPLAY 2 SPAN.
- 3) Calibration is now complete and the bar is scaled for a 0 to 10V input to produce an analog output of 4 to 20mA.

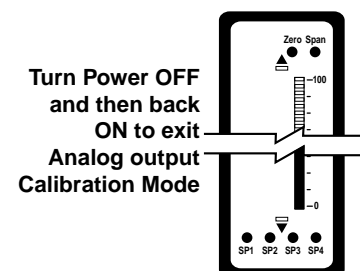

Functional Diagram

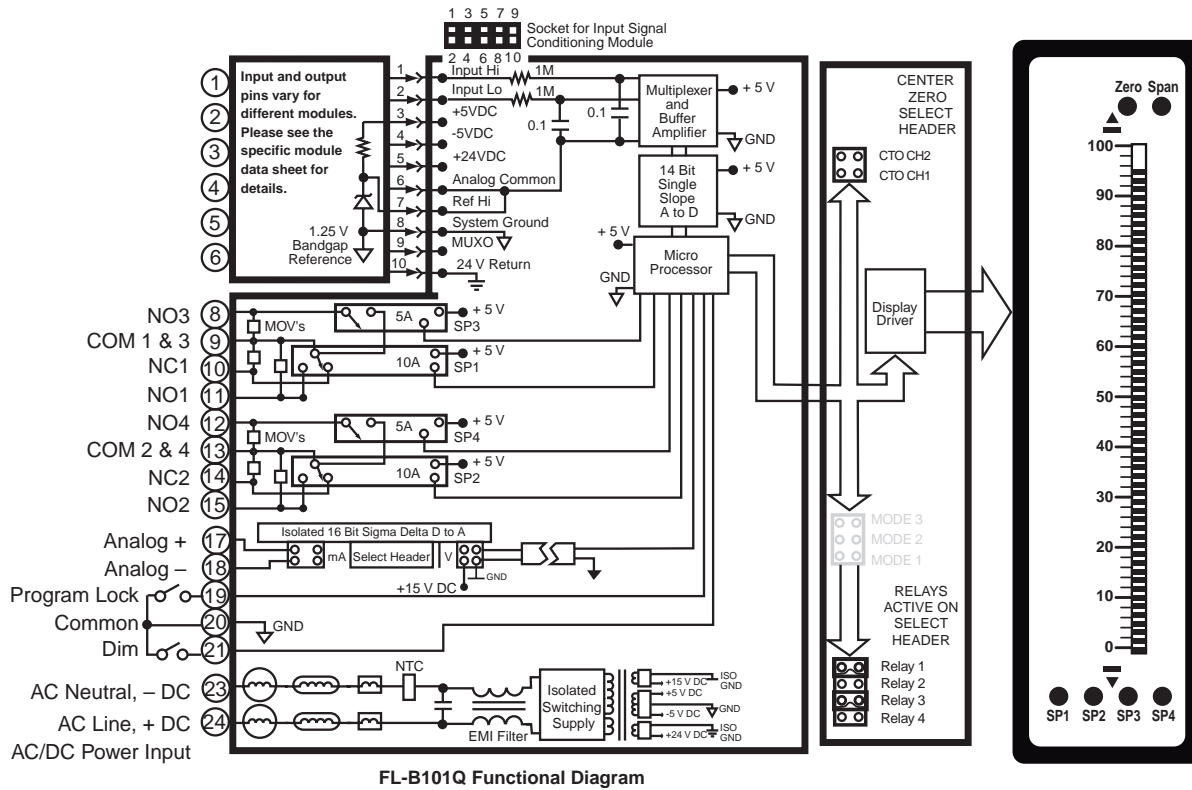

FL-B101Q Functional Diagram

Connector Pinouts

This meter uses plug-in type screw terminal connectors for all input and output connections. The power supply connections (pins 23 and 24) have a unique plug and socket outline to prevent cross connection. The main board uses standard right-angled connectors.

Replacement 2-, 3-, and 4-pin plug connectors are available (see Accessories on page 16).

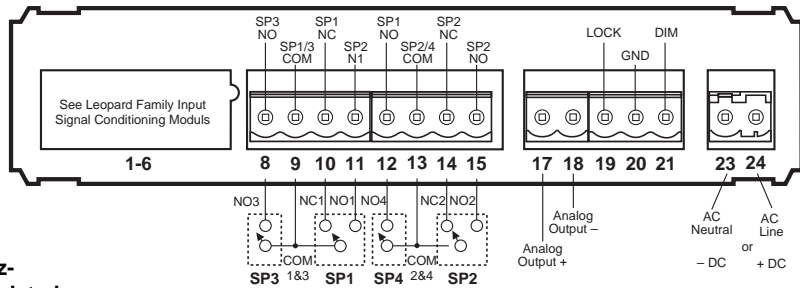

WARNING

AC and DC power supply voltages are hazardous. Make sure the power supply is isolated before connecting to the meter.

Note: The sequence of setpoint outputs on meters shipped prior to 2002 was 1-2-3-4. The sequence is now 3-1-4-2, enabling delay on make (dom) and delay on break (dob) to be used with both Form "C" relays.

Pin Descriptions

Input Signal – Pins 1 to 6

Pins 1 to 6 are reserved for the input signal conditioner. See the data sheet for the selected input signal conditioner.

Pins 8 to 15 – Relay Output Pins

- Pin 8 SP3 NO. Normally Open 5 Amp Form A.
- Pin 9 SP1/3 COM. Common for SP1 and SP3.
- Pin 10 SP1 NC. Normally Closed 10 Amp Form C.
- Pin 11 SP1 NO. Normally Open 10 Amp Form C.
- Pin 12 SP4 NO. Normally Open 5 Amp Form A.
- Pin 13 SP2/4 COM. Common for SP3 and SP4.
- Pin 14 SP2 NC. Normally Closed 10 Amp Form C.
- Pin 15 SP2 NO. Normally Open 10 Amp Form C.

Pins 17 to 21 – Rear Panel Switches

- Pin 17 ANALOG OUTPUT (+). mA (0 to 20 mA/4 to 20 mA) or V (0 to 10 V) output is header selectable.

- Pin 18 ANALOG OUTPUT (-). mA (0 to 20 mA/4 to 20 mA) or V (0 to 10 V) output is header selectable.
- Pin 19 PROGRAMMING LOCK. By connecting the LOCK pin to the COMMON pin, the meter's programmed parameters can be viewed but not changed.
- Pin 20 COMMON. To activate the LOCK or DIM functions from the rear of the meter, the respective pins have to be connected to the COMMON pin. This pin is connected to the internal power supply ground.
- Pin 21 DIM. By connecting the display dim (DIM) pin to the COMMON pin, the display brightness setting is halved.

Pins 23 and 24 – AC/DC Power Input

Auto-sensing AC/DC power supply. For voltages between 85-265 V AC / 95-370 V DC (PS1) or 18-48 V AC / 10-72 V DC (PS2).

- Pin 23 AC Neutral / -DC. Neutral power supply line.
- Pin 24 AC line / +DC. Live power supply line.

Component Layout

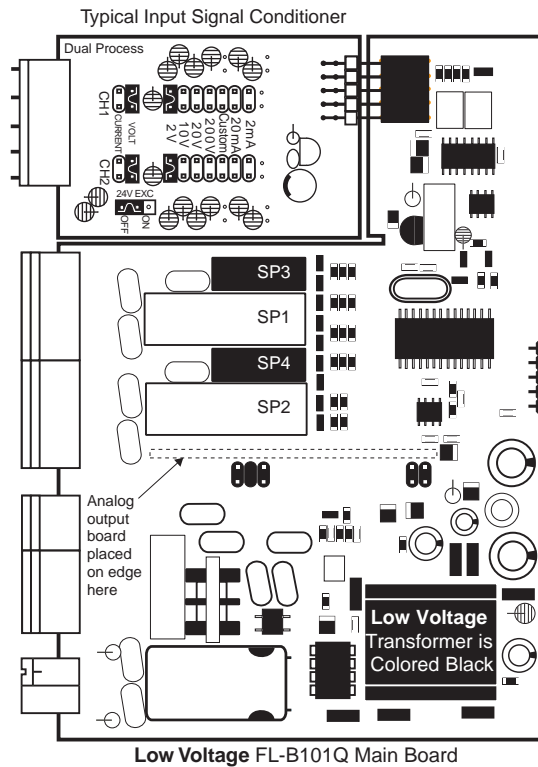
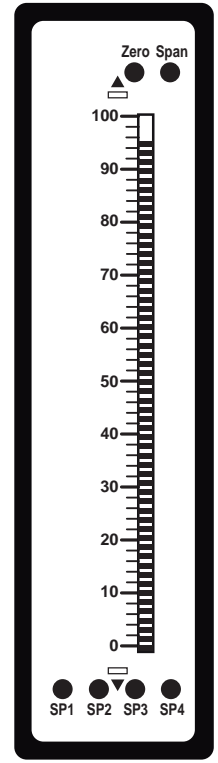
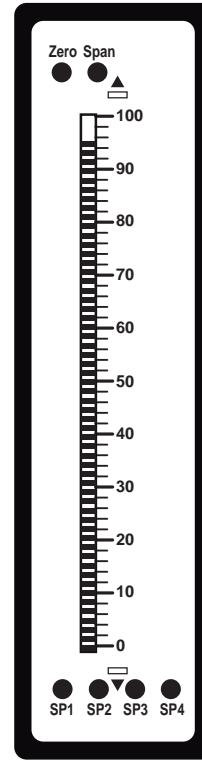
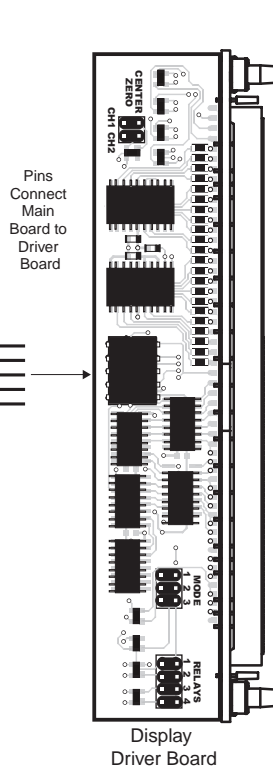
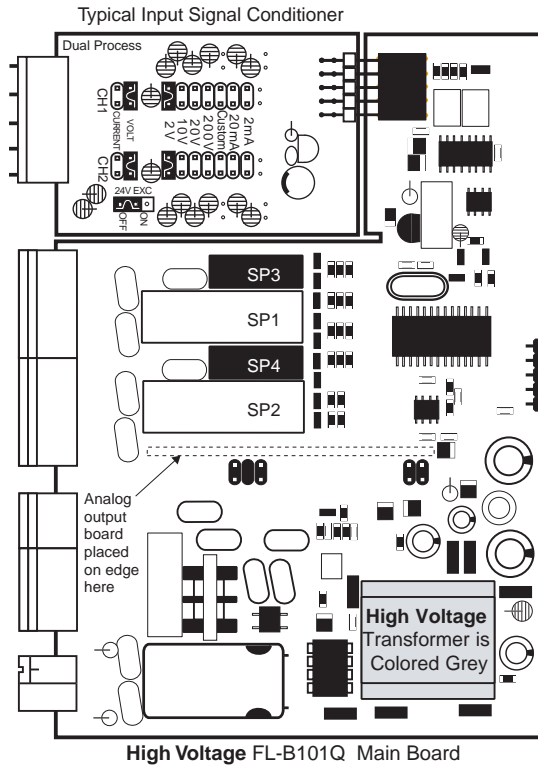

4 to 20 mA (0 to 20 mA) Selection Position Analog Output Selection Header 0 to 10 V DC Selection Position

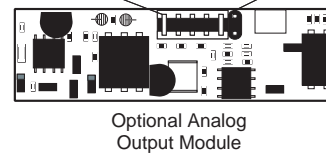

Horizontal Bargraph Order Code FL-101QHZTHR(red) or FL-101QHZTHG(green)

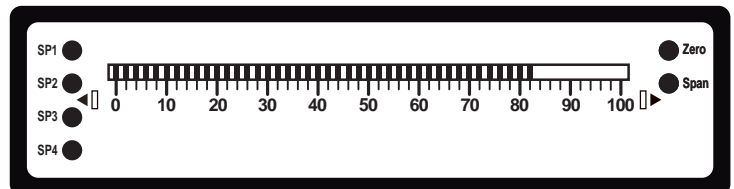

Horizontal Bargraph Order Code FL-101QHBHR(red) or FL-101QHBHG(green)

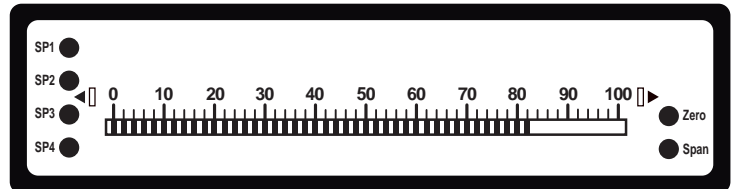

Connectors



WARNING

AC and DC input signals and power supply voltages can be hazardous. Do Not connect live wires to terminal blocks, and do not insert, remove or handle terminal blocks with live wires connected.

Standard plug-in screw terminal blocks provided by Texmate:

Input Power Screw Terminal Plug
Part Number: 93-PLUG2P-DP

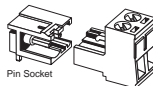

Right-angled Screw Terminal Plug

Part Numbers:
93-PLUG2P-DR...2 pins
93-PLUG3P-DR...3 pins
93-PLUG4P-DR...4 pins
93-PLUG5P-DR...5 pins
93-PLUG6P-DR...6 pins

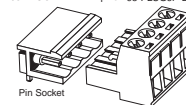

Straight-thru Input Power Screw Terminal Plug
Part Number: 93-PLUG2P-SP

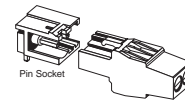

Straight-thru Screw Terminal Plug

Part Numbers:
93-PLUG2P-DS...2 pins
93-PLUG3P-DS...3 pins
93-PLUG4P-DS...4 pins

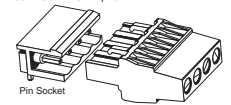









I-Series Input Signal Conditioning Modules

Many additional input modules are available and others are constantly being developed. Check with your local distributor or www.texmate.com for updated information.

Pre-calibrated **I-Series** input modules, that have span or zero potentiometers, can be interchanged between any **I-Series** compatible meter, without recalibration, because all of the analog scaling and reference circuitry is self-contained within the module. Where appropriate, all the standard ranges shown are designed to be header selectable by the user, and Texmate's unique SPAN ADJUST Header facilitates scaling to almost any required engineering unit. See Input Module Component Glossary and Calibration on pages 13 and 14. Also see Two Point Digital Calibration and Digital Calibration on page 4.

Unless otherwise specified Texmate will ship all modules pre-calibrated with factory preselected ranges and/or scalings as shown in **BOLD** type. Other pre-calibrated standard ranges or custom ranges may be ordered. Factory installed custom scaling and other custom options are also available (see Ordering Information, Special Options on last page).

Symbols Indicate Module Compatibility Within Meter Families		
 TIGER Family	 LEOPARD Family	 LYNX Family
 LEOPARD Family	 LYNX Family	 TIGER Family
 LYNX Family	 TIGER Family	 LEOPARD Family
ALL MODELS	SOME MODELS	MODEL SPECIFIC



WARNING: AC and DC input signals and power supply voltages can be hazardous. Do Not insert, remove or handle modules with live wires connected to any terminal plugs.

IA01: AC Volts Scaled RMS, 200/600V AC

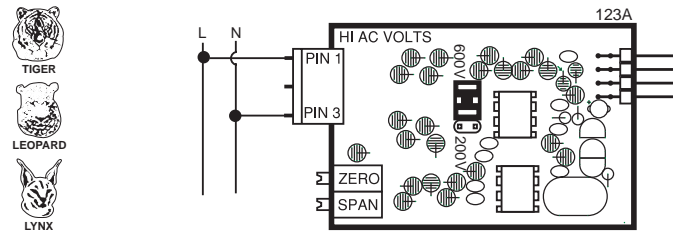

IA06: AC Volts True RMS, 300/600V AC

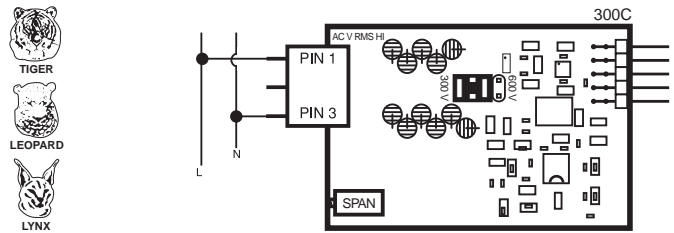

IA02: AC Volts Scaled RMS, 200mV/2V/20V AC

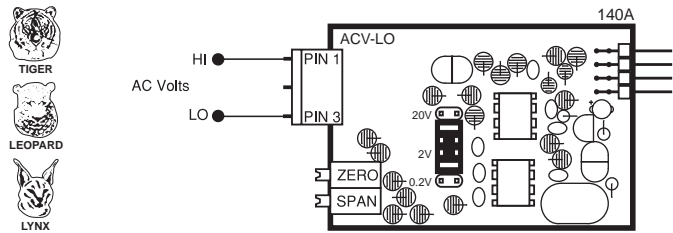

IA07: AC Volts True RMS, 200mV/2V/20V AC

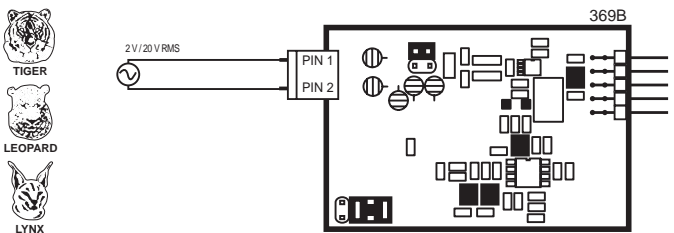

IA03: AC Milliamps Scaled RMS, 2/20/200mA AC

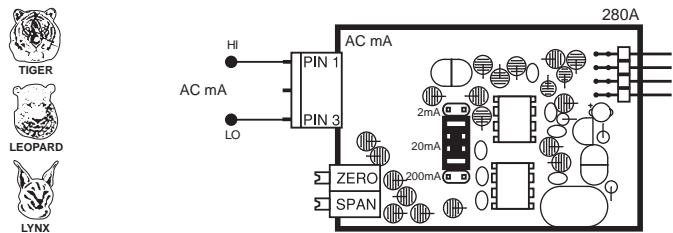

IA08: AC Milliamps True RMS, 2/20/200mA AC

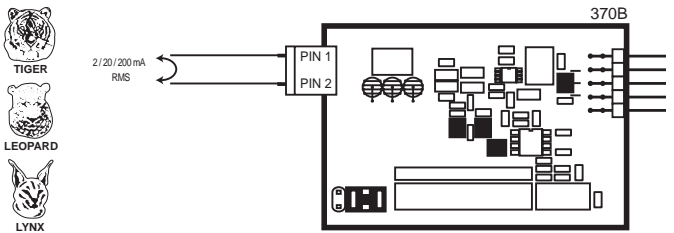

IA04: AC Amps Scaled RMS, 1 Amp AC

IA05: AC Amps Scaled RMS, 5 Amp AC

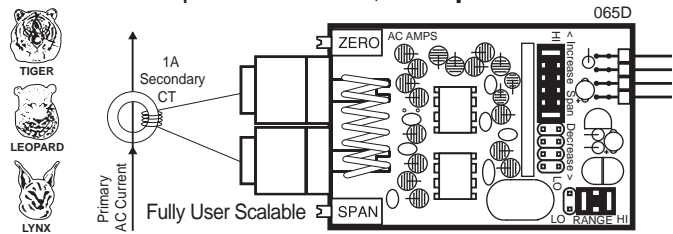

IA09: AC Amps True RMS, 1 Amp AC

IA11: AC Amps True RMS, 5 Amp AC

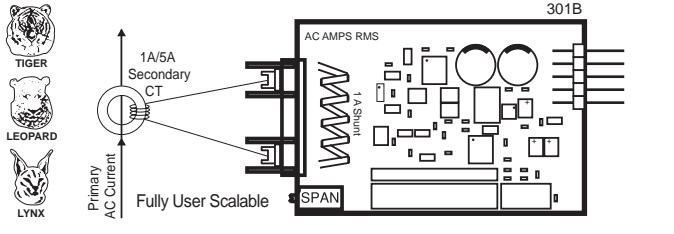

I-Series Input Signal Conditioning Modules

IA10 AC Millivolts, Scaled RMS, 100mV AC

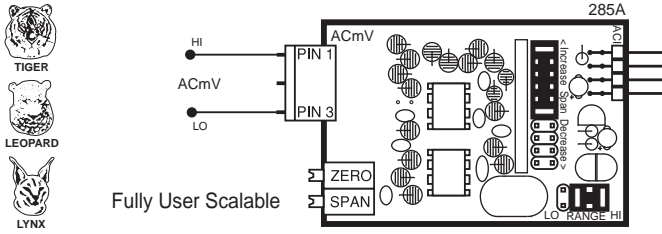

IA12: AC Millivolt RMS Sigma Delta

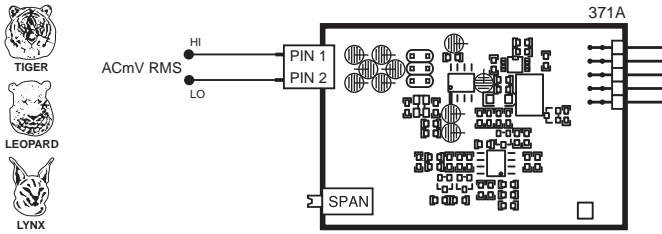

ID05: DC Volts 2/20/200/Custom V DC with Offset and 24V Exc.

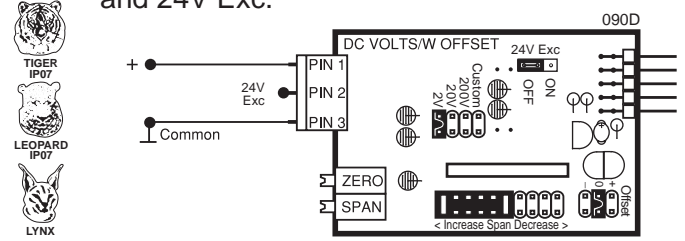

ID07: DC Milliamps, 2/20/200mA DC with Offset and 24V Exc

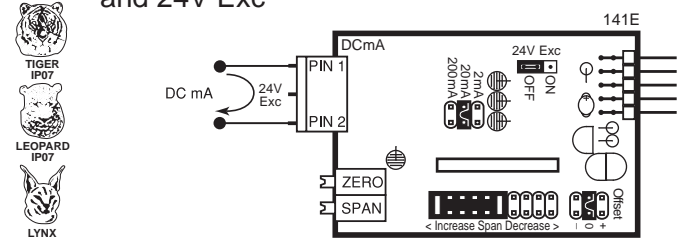

ID01: DC Volts, 2/20/200V/Custom w/24V DC Exc

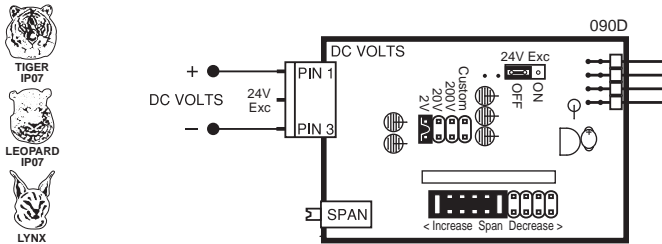

IF02: Line Frequency

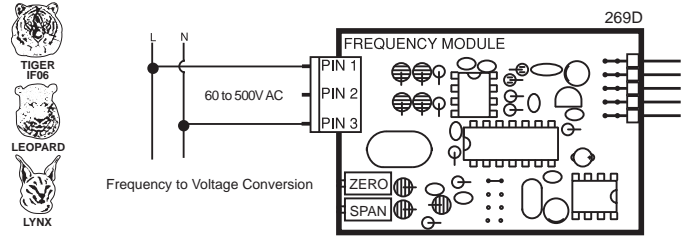

ID02: DC Millivolts, 20/50/100/200mV DC w/24V DC Exc

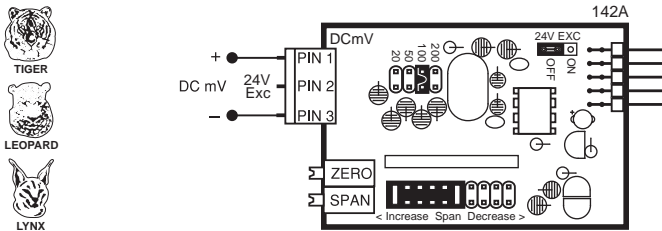

IGYZ: Universal Direct Pressure (Absolute or Differential/Gage)
See below for ordering code options

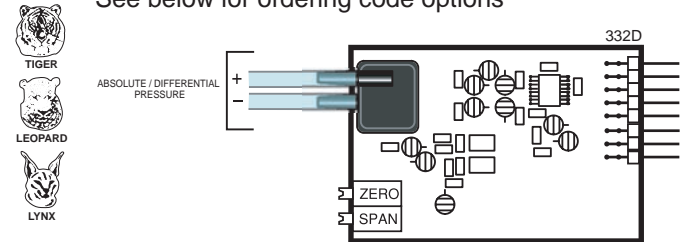

ID03: DC Milliamps, 2/20/200mA DC w/24V DC Exc

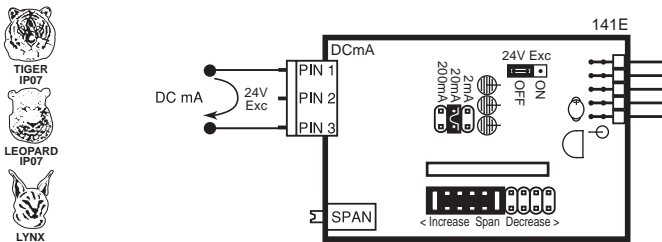

Ordering Code Options for Direct Pressure (IGYX, IGYG & IGYZ)

I G [] [] → For Single Channel IGYX with two digital inputs, the last digit of order code is always X.

For Universal Direct Pressure IGYZ, the last digit of order code is always Z.

Sensor Range	CH1 Order Code	CH2 Order Code
1 psi Absolute	A	A
1 psi Differential	B	B
5 psi Absolute	C	C
5 psi Differential	D	D
15 psi Absolute	E	E
15 psi Differential	F	F
30 psi Absolute	G	G
30 psi Differential	H	H
100 psi Absolute	J	J
100 psi Differential	K	K

ID04: DC Amps, 5A DC
ID09: DC Amps, 1A DC

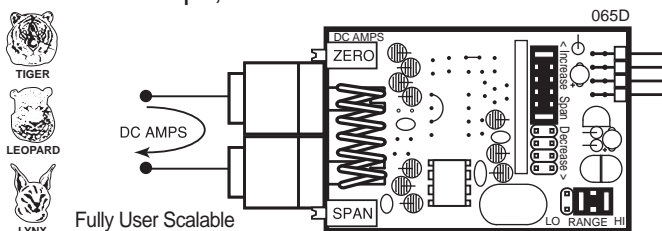

IP01: Process Loop, 4-20mA
IP02: Process Loop, 4-20mA with 24VDC EXC

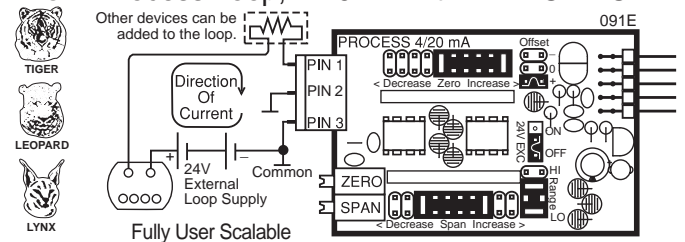

I-Series Input Signal Conditioning Modules

IPO3: Process Input, 1-5V DC with Offset, 24V Exc

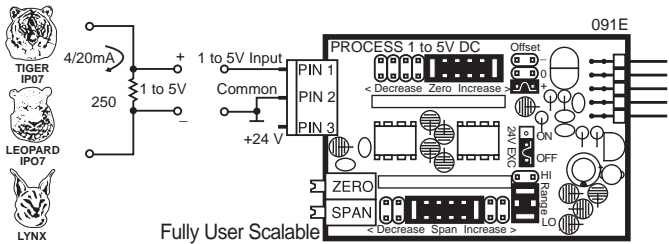

IPO7: Universal Process Input
2V/5V/10V/20V/200V/2mA/20mA/Custom

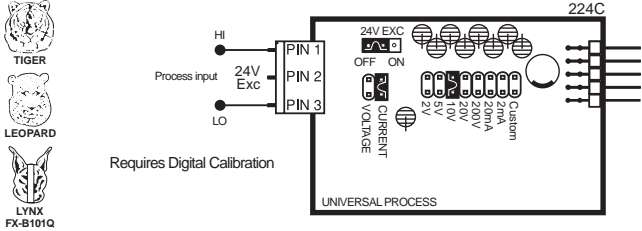

IPT1: Prototype Board for Custom Design

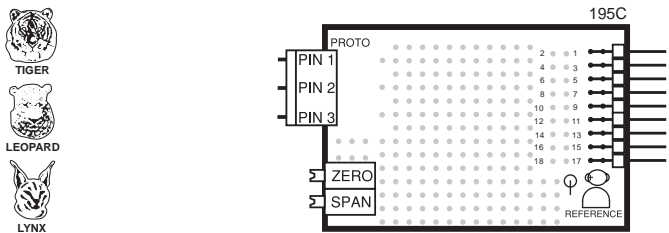

IRO2: 3 wire Potentiometer 1K min (0-F.S.)

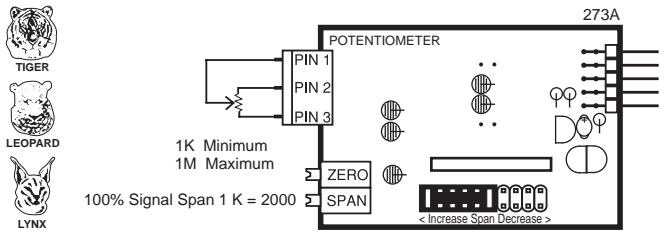

IRO3: Linear Potentiometer 1KΩ min

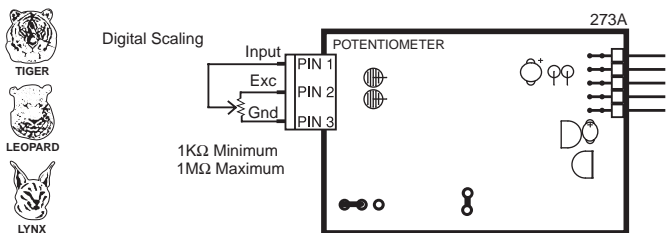

IR04: Resistance 2KΩ (Lynx only)
IR05: Resistance 2KΩ (Leopard only)

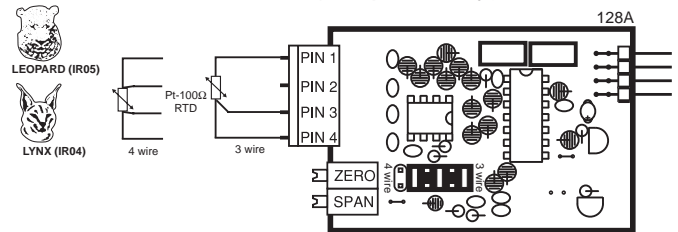

IS01: Strain Gage 5/10VDC Exc., 20/2mV/V, 4/6-wire
IS02: Pressure/Load Cell
5/10VDC Exc., 20/2mV/V, 4/6-wire

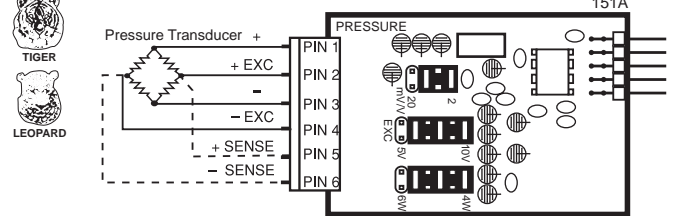

IS04: Pressure/Load Cell Ext Exc., 20/2mV/V, 4/6-wire

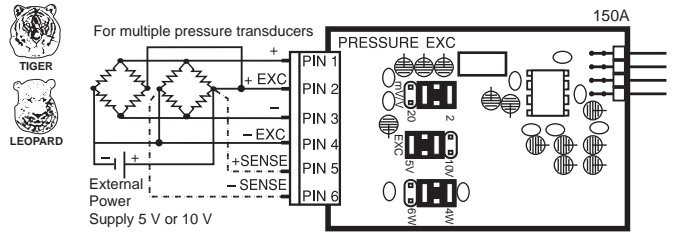

IS05: Pressure/Load Cell 20/2mV/V, 5/10V Exc 4-wire

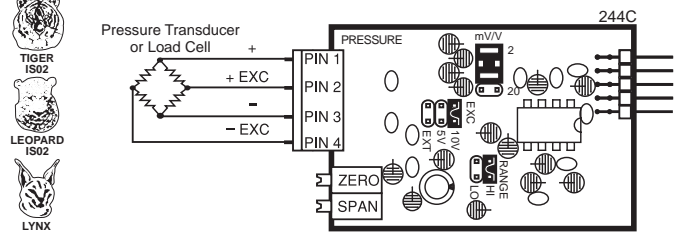

IS06: Pressure/Load Cell Ext Exc., 20/2mV/V, 4-wire

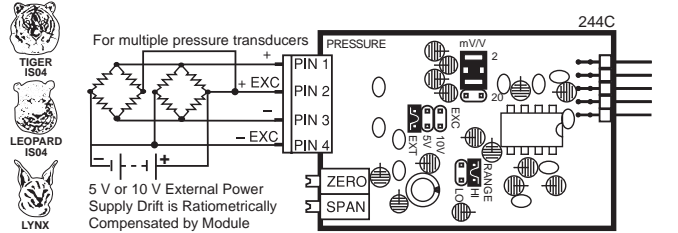

I-Series Input Signal Conditioning Modules

IS07: Pressure/Load Cell Ext Exc. High Impedance, 20/2mV/V, 4/6-wire

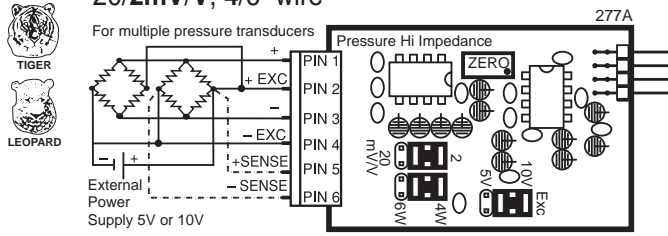

IT03: RTD, 100 Pt. 2/ 3/4-wire (-200 to 800°C)
IT04: RTD, 100 Pt. 2/ 3/4-wire (-200 to 1470°F)
IT05: RTD, 100Ω Pt. 2/3/4-wire (-199.9 to 199.9°F)
IT14: RTD, 100Ω Pt. 2/3/4-wire (-199.9 to 199.9°C)

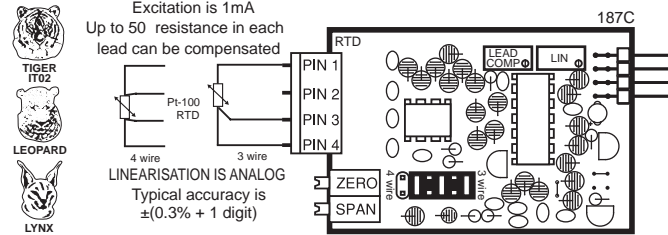

IT06: Thermocouple, J Type (0-1400 °F)

IT08: Thermocouple, J Type (0-760 °C)

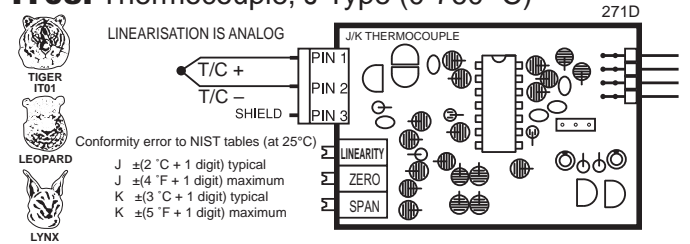

IT07: Thermocouple, K Type (0-1999 °F)

IT09: Thermocouple, K Type (0-1260 °C)

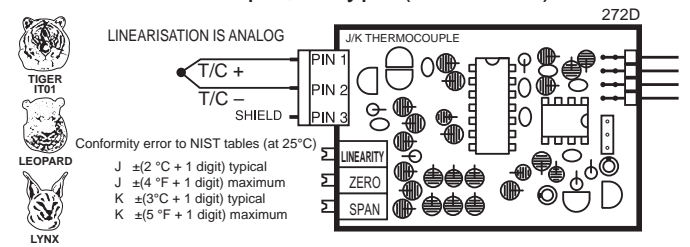

Case Dimensions

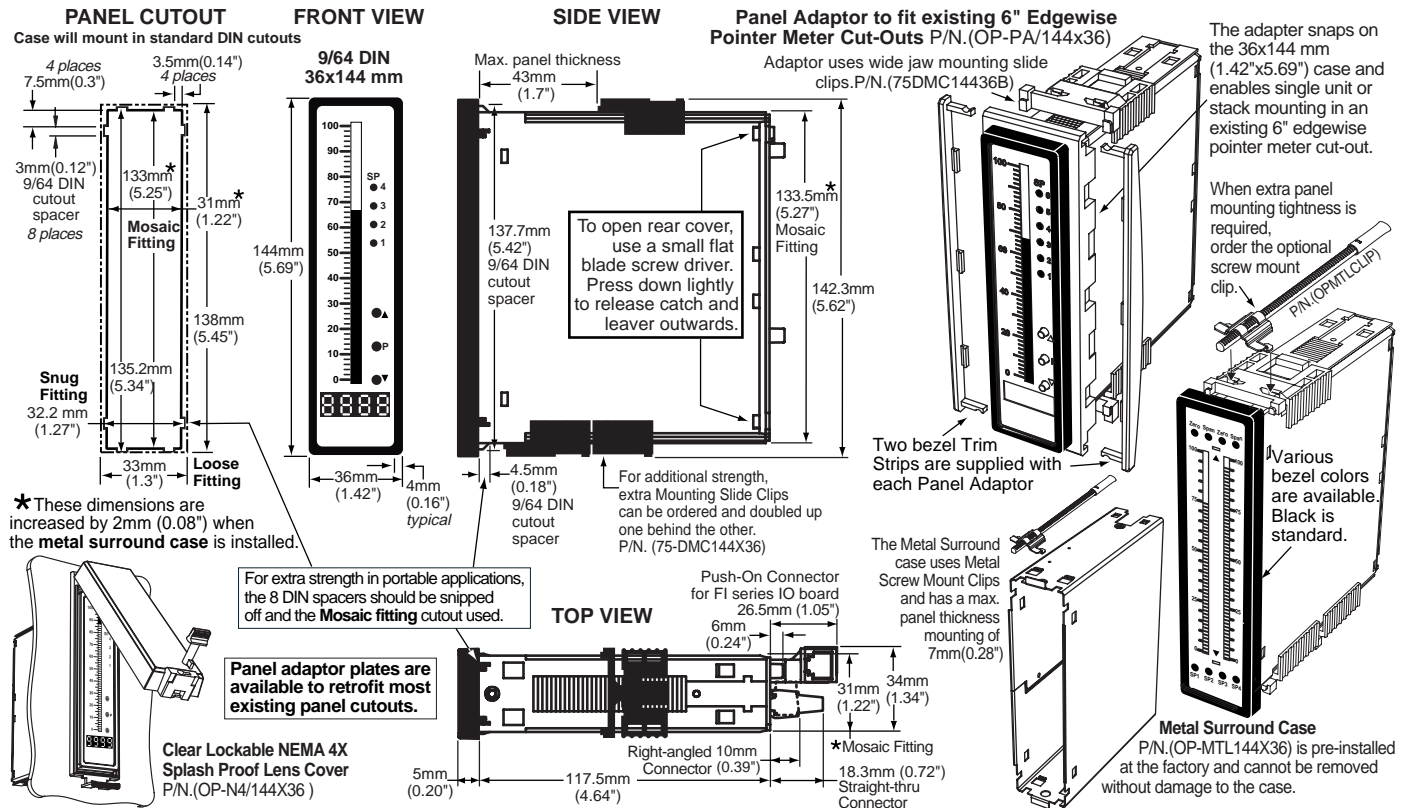

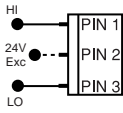

Input and Output Pins

On most modules Pin 1 is the Signal High input and Pin 3 is the Signal Low input. Typically Pin 2 is used for Excitation Voltage output.

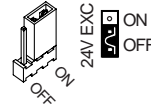

24V DC Output Header

On some modules this header enables a 24V DC 25mA (max) Excitation/Auxiliary output to be connected to Pin 2.

INPUT RANGE Header

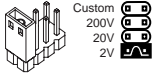

Range values are marked on the PCB. Typically two to four positions are provided, which are selected with either a single or multiple jumper clip. When provided, a custom range position is only functional when the option has been factory installed.

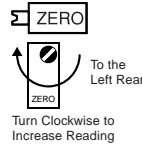

ZERO Potentiometer (Pot)

If provided, the ZERO pot is always to the left of the SPAN pot (as viewed from the rear of the meter). Typically it enables the input signal to be offset $\pm 5\%$ of full scale (-100 to +100 counts).

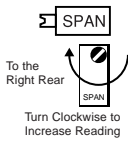
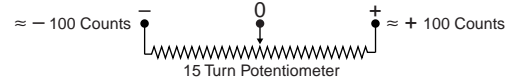

SPAN Potentiometer (Pot)

If provided, the 15 turn SPAN pot is always on the right side (as viewed from the rear of the meter). Typical adjustment is 20% of the input signal range.

ZERO OFFSET RANGE Header

When provided, this three position header increases the ZERO pot's capability to offset the input signal, to $\pm 25\%$ of the digital display span. For example a Negative offset enables a 1 to 5V input to display 0 to full scale. The user can select negative offset, positive offset, or no offset (ZERO pot disabled for two step non-interactive span and offset calibration).

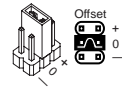

Zero Offset Range Header

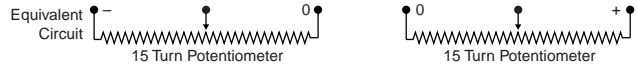
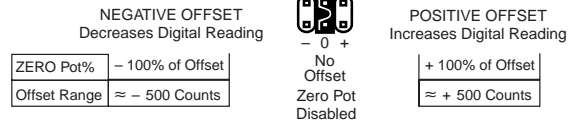

SPAN ADJUST Header

This unique five-position header expands the adjustment range of the SPAN pot into five equal 20% steps, across 100% of the input Signal Span. Any input Signal Span can then be precisely scaled down to provide any required Digital Display span from 1999 counts to 001 (one count).

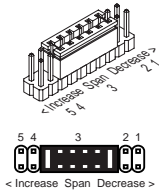

SPAN Adjust Header position	1	2	3	4	5
SPAN Pot %	20%	20%	20%	20%	20%
Signal Span %	20%	40%	60%	80%	100%



ZERO ADJUST Header

When this header is provided, it works in conjunction with the ZERO OFFSET RANGE Header, and expands the ZERO pot's offset capability into five equal negative steps or five equal positive steps. This enables virtually any degree of input signal offset required to display any desired engineering unit of measure.

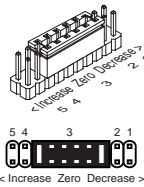

Zero Adjust Range Header

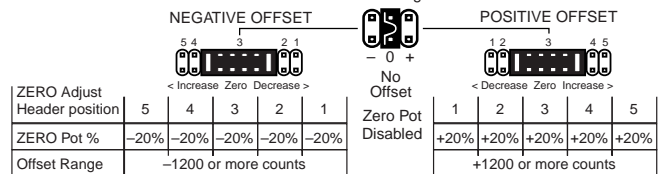

SPAN RANGE Header

When this header is provided it works in conjunction with the SPAN ADJUST Header by splitting its adjustment range into a Hi and a Lo range. This has the effect of dividing the adjustment range of the SPAN pot into ten equal 10% steps across 100% of the input Signal Span.

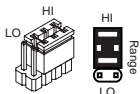

SPAN Adjust Header position	1	2	3	4	5	1	2	3	4	5
SPAN Pot %	10%	10%	10%	10%	10%	10%	10%	10%	10%	10%
Signal Span %	10%	20%	30%	40%	50%	60%	70%	80%	90%	100%

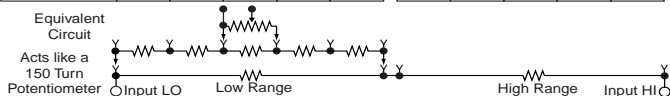

In addition to the analog calibration capabilities that enable many modules to be interchanged between different meters without loss of accuracy, the Neko Family of meters have enhanced Software Calibration Functions. See Page 3 and 4.

Basic standard range calibration of direct reading modules that utilize either Auto Zero or a ZERO pot, an INPUT RANGE Header and or a SPAN pot.

- 1 If the module has an INPUT RANGE Header, reposition the jumper clip to select the desired input signal range.
2. Apply a zero input or short the input pins. The display will auto zero, or if the module has a ZERO pot, it should be adjusted until the display reads zero.
- 3 Apply a known input signal that is at least 20% of the full scale input range and adjust the SPAN pot until the display reads the exact input value. For negative inputs, Neko Family Meters will display negative overrange at 50% of full scale range.
- 4 Decimal Points. The selection or positioning of decimal points has no effect on the calibration of the modules

Wide range scaling, in engineering units not requiring offsets, with modules that utilize auto-zero or a ZERO pot, a SPAN RANGE Header and or a SPAN ADJUST Header.

Texmate's unique SPAN ADJUST and SPAN RANGE Headers provide the circuit equivalent of an ultra-precision one megohm 75 or 150 turn potentiometer that can infinitely scale down any Input Signal SPAN to provide any full scale Digital Display Span from 1999 (counts) to 001 (one count).

If the module has an INPUT RANGE Header, and the required full scale Digital Display Span (counts) is to be larger than the directly measured value of the input Signal Span, then the next lower range on the INPUT RANGE Header should be selected. The resulting over range Signal Span is then scaled down, by selecting the position of the SPAN RANGE Header and or the SPAN ADJUST Header, which will reduce the input Signal Span to a percentage, that the required Digital Display Span can be reached by calibration with the SPAN pot.

Example A: 0 to 10 V to read 0 to 1800 gallons.

Signal Span = 10V, Digital Display Span = 1800 counts

- 1 Select the 2 V INPUT RANGE Header position. This will provide a digital display of 1800 counts with an input of only 1.8 V which is $(1.8 \div 10) = 18\%$ of the examples 10 V Signal Span.
- 2 To scale down the Signal Span to 18% select the 20% Signal Span position on the SPAN ADJUST Header (position 1) or if the module has a SPAN RANGE Header, select (LO Range) and 20% Signal Span position on the SPAN ADJUST Header (position 2).
- 3 Apply a zero input or short the input pins. The display will auto zero, or if the module has a ZERO pot, it should be adjusted until the display reads zero.
- 4 Apply 10 V and adjust the SPAN pot until the display reads 1800.

Large offset scaling and calibration of process signal inputs with modules that utilize ZERO ADJUST Headers and or ZERO OFFSET RANGE Headers.

Texmate's unique ZERO OFFSET RANGE Header enables the use of a simple two step scaling and calibration procedure for those process signals that require large offsets. This eliminates the back and forth interaction, between zero and span settings, that is often required to calibrate less finely engineered products.

The first step is to set the ZERO OFFSET RANGE Header to the center position (No Offset) and scale down the Input Signal Span to a percentage that will enable calibration with the SPAN pot to reach the required Digital Display Span.

The second step is to set the ZERO ADJUST and or ZERO OFFSET RANGE Header to provide a positive or negative offset of sufficient counts that calibration with the ZERO pot will offset the Digital Display Span to produce the required digital reading.

Example B: 1 to 5 V to read -100 to 1500 °C.

Signal Span = 4V, Digital Display Span = 1600 counts

- 1 If the module has an INPUT RANGE Header the 2 V position should be selected. This will provide a digital display of 1600 counts for an input of 1.6 V which is $(1.6 \div 4) = 40\%$ of the examples 4 V signal span. To scale down the Signal Span to 40% select the 40% Signal Span position on the SPAN ADJUST Header (position 2).
- 2 If the module is a Process Input 1-5 V DC type, select the (Hi Range) position on the SPAN RANGE Header and the 100% Signal Span position on the SPAN ADJUST Header (position 5, max increase). This will provide a digital display of 1600 counts for an input of 4V which is 100% of the examples 4V Signal Span.
- 3 Set the ZERO OFFSET RANGE Header to the center position (no offset). Apply 1 V and adjust the SPAN pot until the display reads 400 . A 4V input would then read 1600 counts.
- 4 Set the ZERO OFFSET RANGE Header to the negative offset position. If the module has a ZERO ADJUST Header select the position that will provide a negative offset of ≈ -500 counts. Apply 1 V and adjust the ZERO pot until the display reads -100. Apply 5 V and check that the display reads 1500.

Example C: 4 to 20 mA to read 00.0 to +100.0%

Signal Span = 16 mA, Digital Display Span = 1000 counts.

- 1 The full scale Signal Span of the Process Input 4-20 mA modules is 0 to 20 mA for a full scale Digital Display Span of 0 to 2000 counts. This will provide a digital display of 1000 counts with an input of only 10 mA which is $(10 \div 16) = 62.5\%$ of the examples 16 mA signal span.
- 2 To scale down the Signal Span to 62.5% select the (Hi Range) Position on the Span Range Header and the 70% Signal Span position on the SPAN ADJUST Header (position 2).
- 3 Set the ZERO OFFSET RANGE Header to the center position (no offset). Apply 4 mA and adjust the SPAN pot until the display reads 250 . A 16 mA input would then read 1000 counts.
- 4 Set the ZERO OFFSET RANGE Header to the positive offset position. If the module has a ZERO ADJUST Header select the position that will provide a negative offset of ≈ -250 counts. Apply 4 mA and adjust the ZERO pot until the display reads 000. Apply 20 mA and check that the display reads 1000.

Standard Face Plates and Scales

Unless otherwise specified, a standard 0-100 scaled face plate with white letters on a black background is provided with each meter. In those cases where a temperature module is ordered, a 0 – 200°F (white on black) face plate will be provided as standard.

Alternatively a face plate with black letters on a white background or a blank, white or black face plate, may be ordered as a no charge substitute. For temperature applications there are also several different optional face plates that may be ordered as a no charge substitute. (See below). Customized face plates with special scaling can also be ordered (see following page).

76-FLBQ/BVR Standard 76-FLBQ/WVR Optional 76-FLBQ/BVRX Optional 76-FLBQ/WVRX Optional

Face plates supplied with temperature modules.

76-FLBQ/BHB Standard Horizontal
76-FLBQ/WHB Optional
76-FLBQ/BHBX Optional
76-FLBQ/WHBX Optional

Other optional face plates for temperature are also available in the following ranges:

- 0 to 200
- 0 to 1000
- 200 to +200 (Zero Center Mode)

When ordering, specify white letters on a black background or black letters on a white background. Horizontal or vertical format and °F or °C caption.

Standard Scales and Caption Sheets (white or black lettering for do-it-yourself customizing)

Clear self-adhesive caption sheets with white or black lettering are provided for each meter shipped with a standard or optional faceplate.

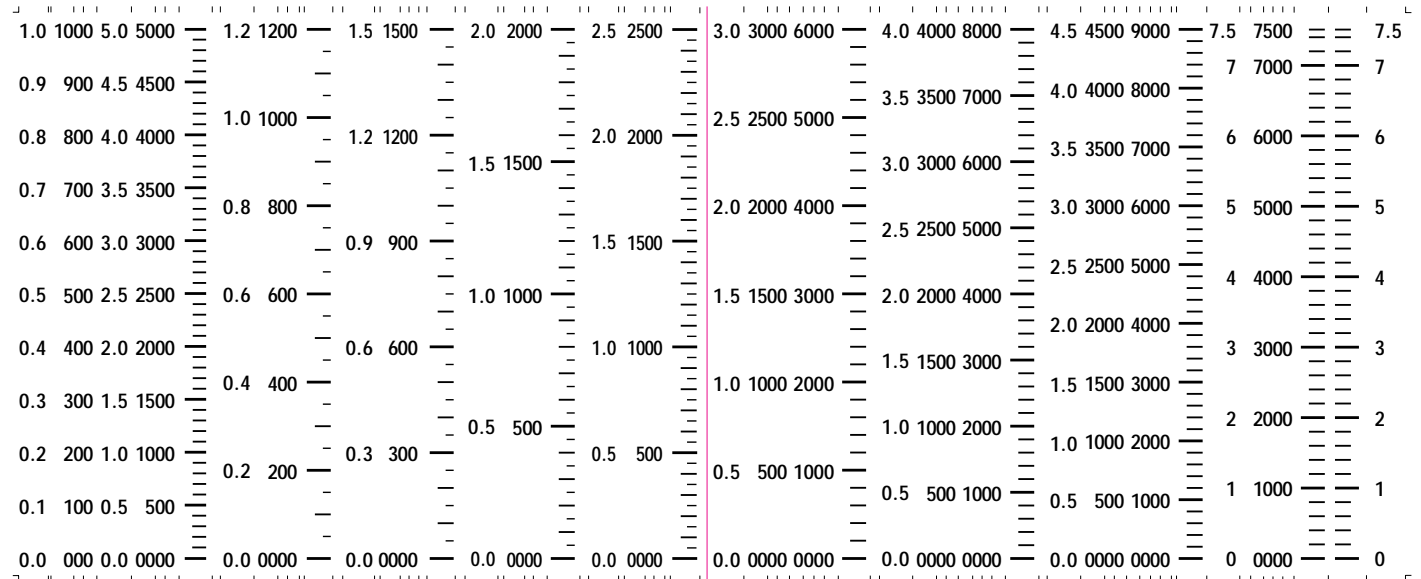

A	AC	E _b	Btu	bars	CFH	BHP	Low	inch/	CosØ	AMPS	BBL/HR	AHEAD	AC Vars	AC Amperes	AC Kilowatts	AIR PRESSURE	AC Milliampers
J	Ah	KJ	bar	cal ₁₅	CFM	IPS	High	Kcal	FEET	GALS	BBL/MIN	ALARM	AC Volts	AC Kilovars	AC Millivolts	AC Kiloamperes	Battery Voltage
K	cd	kV	cal	cm ⁻¹	CFS	IPH	MGD	kg/hr	Hold	INHg	DEG/MIN	BOILER	AC Watts	AC Kilovolts	BPH X 1000	AC Megavars	Backup Voltage
l	dB	kW	cm	cm ²	COS	Kg/h	Mld	kVAR	Km ³ /h	m/min	FT H ₂ O	Cycles	BEARING	AIR FLOW	CFH x 1000	AC Megawatts	DC Displacement
m	DC	ml	FT ³	cm ³	CPH	KPH	MPH	kW/s	MWH	m/sec	In. H ₂ O	Depth	COOLANT	BBLs/HOUR	DC Amperes	AC Watts/Vars	DC Amps to Ground
V	FT	NL	lbs	dm ³	CPM	KPM	MPS	RPM	mWs	Nm ³ /h	Kg/cm ²	HEATER	DC Volts	BFM AMPS	DC Kilovolts	CENTIMETERS	DC Microamperes
α	HP	Pa	IN ²	H ₂ O	CPS	KPS	N/m ²	MPM	mbar	Ohms	KNOTS	Height	DC Watts	BHP x 100	DC Kilowatts	DC Kiloamperes	DC Milliampers
β	Hz	PF	kg/	kPa	DCA	kWH	ORP	M ³ /hr	ml/m ³	PSIA	kg/sec	Hertz	Degrees	BLOWER	DC Millivolts	FD FAN AMPS	GALLONS / MINUTE
φ	Kg	pH	mA	l/s	FPH	lb/ft	PPH	Upm	mm/s	PSID	Mvars	Hours	ENGINE	DC Current	FPM X 100	IN. H ₂ O PRESS	GENERATOR AMPS
Ω	kA	sin	mS	l/h	FPM	lb/in	PPM	VAC	Peak	PSIG	mmH ₂ O	INCHES	EXHAUST	Dew Point	FPM X 1000	LBS/MINUTE	LBS PER GALLON
Δ	L ³	t/h	mV	l/m	FPS	LPH	PPS	Vars	PORT	PSIR	mmHg	Input	Humidity	Degrees C	GPM X 1000	LEVEL INCHES	LOAD LIMIT PERCENT
μ	m ³	yd ³	Nm	lb/h	GAL	LPM	RPH	VDC	STRB	SCFM	VOLTS	PORT	METERS	Degrees F	HORSEPOWER	LEVEL GALLONS	MANIFOLD PRESSURE
∂	W	μA	oz	MW	GMP	LPS	RPS	w/m ²	TARE	TORR	%LOAD	PUMP	Output	Degrees K	INCHES WC	LEVEL PERCENT	MILL LOAD AMPS
γ	°C	μS	RH	min	GPH	m ³ /h	phi	YPM	TONS	U/min	%OPEN	Preset	Percent	Degrees R	INCHES H ₂ O	MILLIMETERS	MOTOR LOAD AMPS
%	°F	μV	1/h	mm	GPM	m ³ /m	psi	YPS	X100	x10kN	→	Reset	Program	FPM X 10	KILOWATTS	Percent Current	Percent Horsepower
∠	°K	μΩ	μm	Sm ³	GPS	m ³ /S	X10	μPa	%KW	X1000	←	SHAFT	Pounds	Frequency	LBS X 1000	Percent Load	OXYGEN PERCENT
												SPEED	Pulses	FUEL FLOW	MEGAWATTS	PERCENT OPEN	TEMPERATURE °C
												Setup	RUDDER	GALLONS	Power Factor	RATE of TURN	TEMPERATURE °F
												TABLE	SPINDLE	IN. WATER	Phase Angle	STEAM TEMP °F	Motor Load Percent
												Total	SQ ROOT	LEVEL FT.	RPM X 100	TONS / HOUR	LEFT RIGHT
												VALVE	Set Point	LBS X 100	STARBOARD	OIL PRESSURE	FRONT REAR
												Valley	THRUST	POSITION	TANK LEVEL	WATER LEVEL	FORWARD REVERSE
												WATTS	TURBINE	TONS X 10	VAC MM HG	1000 LBS/HOUR	TOP BOTTOM (L119)

Ordering Information

BASIC MODEL #	DISPLAY	POWER SUPPLY	INPUT MODULES	ANALOG OUTPUT	RELAY OUTPUT	OPTIONS / ACCESSORIES
FL-B101Q						OA

Add to the basic model number the order code suffix for each standard option required. The last suffix is to indicate how many different special options and or accessories that you may require to be included with this product.

Ordering Example: FL-B101Q-RVR-PS1-IA01-OIC-R11-OA2 plus CR-CHANGE and an OP-N4/144X36

► BASIC MODEL NUMBER

FL-B101Q . . .144x36mm, Leopard, 101 Segment Bargraph, 4 Digit

Standard Options for this Model Number

Order Code Suffix	Description
► DISPLAY	
BHG	Green LED Bargraph, Horizontal, Bottom position
BHR	Red LED Bargraph, Horizontal, Bottom position
CHG	Green LED Bargraph, Horizontal, Center position
CHR	Red LED Bargraph, Horizontal, Center position
CHT	Center Horizontal - Tri-Color
CVG	Green LED Bargraph, Vertical, Center position
CVR	Red LED Bargraph, Vertical, Center position
CVT	Center Vertical - Tri-Color
LVG	Green LED Bargraph, Vertical, Left side
LVR	Red LED Bargraph, Vertical, Left side
RVG	Green LED Bargraph, Vertical, Right side
RVR	Red LED Bargraph, Vertical, Right side
THG	Green LED Bargraph, Horizontal, Top position
THR	Red LED Bargraph, Horizontal, Top position

► POWER SUPPLY

PS185-265VAC/95-370VDC
PS215-48VAC/10-72VDC

► INPUT MODULES (Partial List. See www.texmate.com)

Unless otherwise specified Texmate will ship all modules precalibrated with factory preselected ranges and/or scalings as shown in **BOLD** type.

IA01 . . . AC-Volts Scaled RMS, **200/600V AC**
IA02 . . . AC-Volts Scaled RMS, **200mV/2V/20V AC**
IA03 . . . AC-mA Scaled RMS, **2/20/200mA AC**
IA04 . . . AC-Amps Scaled RMS, **0-1 Amp AC (0-100.00)**
IA05 . . . AC-Amps Scaled RMS, **0-5 Amp AC (0-100.00)**
IA06 . . . AC-Volts True RMS, **200/600V AC**
IA07 . . . AC-Volts True RMS, **200mV/2V/20V AC**
IA08 . . . AC-mA True RMS, **2/20/200mA AC**
IA09 . . . AC-Amps True RMS, **0-1 Amp AC (0-100.00)**
IA10 . . . AC-Millivolt, Scaled RMS, **100mV AC**
IA11 . . . AC-Amps True RMS, **0-5 Amp AC (0-100.00)**
IA12 . . . AC-Millivolt, True RMS, **100mV AC**
ID01 . . . DC-Volts, **2/20/200V/Custom w/24V DC Exc**
ID02 . . . DC-Millivolt, **20/50/100/200mV DC w/24V DC Exc**
ID03 . . . DC-Milliamper, **2/20/200mA DC w/24V DC Exc**
ID04 . . . DC-Amps, **5A DC**
ID05 . . . DC-Volts **2/20/200/Custom V DC w/Offset and 24V Exc**
ID07 . . . DC-Milliamper, **2/20/200mA DC w/Offset and 24V Exc**
ID09 . . . DC-Amps, **1A DC**
IF02 . . . Line Frequency, 50-500VAC, 199.9Hz, or optional 400Hz
IGYZ* . . . Universal Direct Pressure
*View the IG- Ordering Code on page 13 to determine the value for Y & Z (IGAZ to IGKZ)
IP01 . . . Process Loop, **4-20mA(0-100.00)**
IP02 . . . Process Loop, **4-20mA(0-100.00)** w/24VDC Exc
IP03 . . . Process Input, **1-5V DC(0-100.00)** w/Offset, 24V Exc
IP07 . . . Universal Process **2V/5V/10V/20V/200V/2mA/20mA/Custom**
IPT1 . . . Prototype Board for Custom Design
IR02 . . . 3-Wire Potentiometer **1KΩ** min (0-F.S.)
IR03 . . . Linear Potentiometer, 3-wire, **1KΩ** min
IR05 . . . Resistance **2KΩ**
IS01 . . . Strain Gage 5/10VDC Exc., **20/2mV/V, 4/6-wire**
IS02 . . . Pressure 5/10VDC Exc., **20/2mV/V, 4/6-wire**

IS04 . . . Pressure Ext Exc., **20/2mV/V, 4/6-wire**
IS05 . . . Pressure/Load Cell **20/2mV/V, 5/10V Exc 4-wire**
IS06 . . . Pressure/Load Cell Ext Exc., **20/2mV/V, 4-wire**
IS07 . . . Pressure 20/2mV/V with High Impedance and External Excitation
IT03 . . . RTD, **100Ω Pt. 2/3/4-wire (-200 to 800°C)**
IT04 . . . RTD, **100Ω Pt. 2/3/4-wire (-200 to 1470°F)**
IT05 . . . RTD, **100Ω Pt. 2/3/4-wire (-190.0 to 199.0°F)**
IT06 . . . Thermocouple, J Type **(0-1400 °F)**
IT07 . . . Thermocouple, K Type **(0-1999°F)**
IT08 . . . Thermocouple, J Type **(0-760 °C)**
IT09 . . . Thermocouple, K Type **(0-1260°C)**

► ANALOG OUTPUT

OICIsolated 16 Bit Current Output, 4-20mA
OIVIsolated 16 Bit Voltage Output, 0-10VDC

► RELAY OUTPUT

R11Single 10A Form C Relay
R12Dual 10A Form C Relays
R13Dual 10A Form C & One 5A Form A Relays
R14Dual 10A Form C & Dual 5A Form A Relays
R15Single 10A Form C & Dual 5A Form A Relays
R16Single 10A Form C & Single 5A Form A Relays

Special Options and Accessories

Part Number	Description
► SPECIAL OPTIONS (Specify Inputs or Outputs & Req. Reading)	
CR-CHANGE	Range change from the standard input as shown in BOLD type
CS-BAR	Custom Scaling within any Strnd. or Custom Selectable Range
COA-BAR	Custom Output - Special Scaling of Analog Output
CSR-SETUP	NRC to Set-up Custom Selectable Range
CSR-INSTL	Installation of Custom Selectable Range
CSS-SETUP	NRC to Set-up Custom Special Scaling
CSS-BR/INSTL	Installation of custom special scaling of bargraph
COR-SETUP	NRC to Set-up Relays in non-standard locations
COR-INSTL	Installation of Relays in non-standard locations
CCL-SETUP	NRC to Set-up Custom Configuration - Functions, Codes
CCL-INSTL	Factory Installation - Custom Configuration

► ACCESSORIES (Specify Serial # for Custom Artwork Installation)

75-DBZ144X36 . . . Black bezel for 144x36mm Case
75-DMC14436B . . . Wide Jaw Side Slide Brackets - wider than standard (2 pc)
75-DMC144X36 . . . Side Slide Brackets-stand. (2 pc) - extra set
93-PLUG2P-DP . . . Extra Screw Terminal Conn., 2 Pin Power Plug
93-PLUG2P-DR . . . Extra Screw Terminal Conn., 2 Pin Plug
93-PLUG3P-DR . . . Extra Screw Terminal Conn., 3 Pin Plug
93-PLUG4P-DR . . . Extra Screw Terminal Conn., 4 Pin Plug
93-PLUG5P-DR . . . Extra Screw Terminal Conn., 5 Pin Plug
DN.CAS144X36 . . . Complete 144x36mm Case with bezel
OP-MTL144X36 . . . Metal Surround Case, includes screw mounting clips
OP-MTLCLIP . . . Screw Mounting Clips (2 pc) - to screw tighten slide brackets
OP-N4/144X36 . . . 144x36mm clear lockable front cover-NEMA 4X, splash proof
OP-PA/144X36 . . . Panel Adapter for 144x36mm from 6 inch cutout
ART-LM-S/C/D . . . Custom Label, Meter - Artwork & set-up + Co. Desc
ART-FS-S/D/C . . . NRC for artwork & set-up Faceplate/Desc/Co.Logo
ART-FS-S/D . . . NRC for artwork & set-up Faceplate/Desc
ART-FS-001 . . . Install Custom Faceplate per meter - 1 color
ART-FB-002 . . . Produce & Install Custom Faceplate per meter - 2 color
ART-FB-003 . . . Produce & Install Custom Faceplate per meter - 3 color

Many other options and accessories are available. See full price list for more details. Prices subject to change without notice.

WARRANTY

Texmate warrants that its products are free from defects in material and workmanship under normal use and service for a period of one year from date of shipment. Texmate's obligations under this warranty are limited to replacement or repair, at its option, at its factory, of any of the products which shall, within the applicable period after shipment, be returned to Texmate's facility, transportation charges pre-paid, and which are, after examination, disclosed to the satisfaction of Texmate to be thus defective. The warranty shall not apply to any equipment which shall have been repaired or altered, except by Texmate, or which shall have been subjected to misuse, negligence, or accident. In no case shall Texmate's liability exceed the original purchase price. The aforementioned provisions do not extend the original warranty period of any product which has been either repaired or replaced by Texmate.

USER'S RESPONSIBILITY

We are pleased to offer suggestions on the use of our various products either by way of printed matter or through direct contact with our sales/application engineering staff. However, since we have no control over the use of our products once they are shipped, NO WARRANTY WHETHER OF MERCHANTABILITY, FITNESS FOR PURPOSE, OR OTHERWISE is made beyond the repair, replacement, or refund of purchase price at the sole discretion of Texmate. Users shall determine the suitability of the product for the intended application before using, and the users assume all risk and liability whatsoever in connection therewith, regardless of any of our suggestions or statements as to application or construction. In no event shall Texmate's liability, in law or otherwise, be in excess of the purchase price of the product.

Texmate cannot assume responsibility for any circuitry described. No circuit patent or software licenses are implied. Texmate reserves the right to change circuitry, operating software, specifications, and prices without notice at any time.



1934 Kellogg Ave. Carlsbad, CA 92008

Tel: 1-760-598-9899 • USA 1-800-839-6283 • That's 1-800-TEXMATE

Fax: 1-760-598-9828 • Email: sales@texmate.com • Web: www.texmate.com

For product details visit www.texmate.com

Local Distributor Address