

## Associated Documents

The following documents must be read together with this supplement:

### Relevant Tiger 320 Series User Manual

The user manual provides general information on the relevant Tiger 320 Series meter.

### Tiger 320 Series Programming Code Sheet

Programming Code Sheet (NZ101) provides all meter programming codes including setpoint programming codes.

### Analog Output Module Supplement (NZ200)

This supplement provides detailed descriptions of the analog output module.

### Serial Communications Module Supplement

Serial Communications Module Supplement (NZ202) provides detailed descriptions of the linearizing function.

### Linearizing Supplement (NZ207)

This supplement provides detailed descriptions of the linearizing function.

### Totalizing Supplement (NZ208)

This supplement provides detailed descriptions of the totalizing function.

### This document was written using Tiger 320 Series Code Version 3.02n.

The totalizer for earlier versions of code may differ to that shown.

Consult your Programming Code Sheet (NZ101) for relevant totalizer settings.



### Programming Tip

This document has been written using a DI-50 7-segment, 5-digit display meter. When programming meters with other display options, some display readings may vary to the diagrams shown.

This document is designed to supplement the calibration mode information described in Tiger 320 Series user manuals.

# Contents

Calibration Mode .....	3
Calibration Mode Programming Codes .....	4
Technical Description .....	6
On Demand Functions.....	7
Input & Output Signal Calibration Procedures .....	10
Related Calibration Functions .....	14
On Demand Tare Procedures .....	19
On Demand Single-point Calibration Procedures .....	20
On Demand Two-point Calibration Procedures.....	21
On Demand Primary Input Compensation Procedures.....	22
On Demand Manual Loader Mode Procedures.....	24
Manual Calibration Procedure .....	26
Two-point Calibration Procedure.....	27
Thermocouple Calibration Procedures.....	28
RTD Calibration Procedures.....	32
Analog Output Calibration Procedures .....	36
Serial Communications Properties Procedure.....	39
Auto Zero Maintenance Procedure .....	40
Averaging Samples & Averaging Window Procedure .....	42
Totalizer Settings Procedure .....	43
32-point Linearization Table Setup Procedures.....	45

## List of Figures

Figure 1 – Calibration Mode Programming Code List .....	3
Figure 2 – Meter Programming Digits for Calibration Mode Functions.....	4
Figure 3 – Linearization Table De-activate/Re-activate Process .....	6
Figure 4 – On Demand Single-point Calibration.....	7
Figure 5 – On Demand Two-point Calibration.....	8
Figure 6 – On Demand Primary Input Compensation.....	8
Figure 7 – On Demand Manual Loader Mode.....	9
Figure 8 – Two-point Calibration .....	10
Figure 9 – Thermocouple Calibration.....	11
Figure 10 – RTD Calibration.....	12
Figure 11 – Multimeter to Meter Connections .....	13
Figure 12 – Input Signal Sampling Showing Averaging Window .....	15
Figure 13 – Linearization Table Date Setup.....	17
Figure 14 – Multimeter to Meter Connections .....	36
Figure 15 – Example of Manual and Auto Linearization Data.....	45

## General Notices & Tips

The range of Tiger 320 Series supplements contain three graphic symbols to aid you:



### WARNING Symbol

The WARNING symbol is generic to all Tiger 320 Series documents and indicates that if the instruction is not heeded, the action may result in loss of life or serious injury.



### NOTE Symbol

The NOTE symbol is generic to all Tiger 320 Series user manual supplements and indicates important or helpful information on the topic being discussed.



### PROGRAMMING TIP Symbol

The programming tip symbol is generic to all Tiger 320 Series documents and indicates useful tips when programming the instrument.

## Definitions

The following definitions are relevant to this document:

### X

If an X appears in the description of a 3-digit programming code or in a configuration procedure, this means that any number displayed in that digit is not relevant to the function being explained, or more than one choice can be made.

### Meter – Controller

The term meter, as used throughout this document, is a generic term for all Tiger 320 Series signal processors and controllers

# Calibration Mode

Tiger 320 Series meters have a versatile array of individual calibration functions. The calibration mode is divided into three main areas of calibration:

See Figure 1.

- On Demand Functions (functions activated by pressing the PROGRAM button for 4 seconds).
- Input and Output Signal Calibration Procedures.
- Related Calibration Procedures.

## Main Programming Mode

The calibration mode is a sub-menu of the main programming mode and is where all input and output signals are calibrated. To access the calibration mode, enter the main programming mode by pressing the meter's **[P]** and **[↑]** buttons at the same time. Press the **[P]** button again to pass through the display brightness menu and enter the calibration mode.

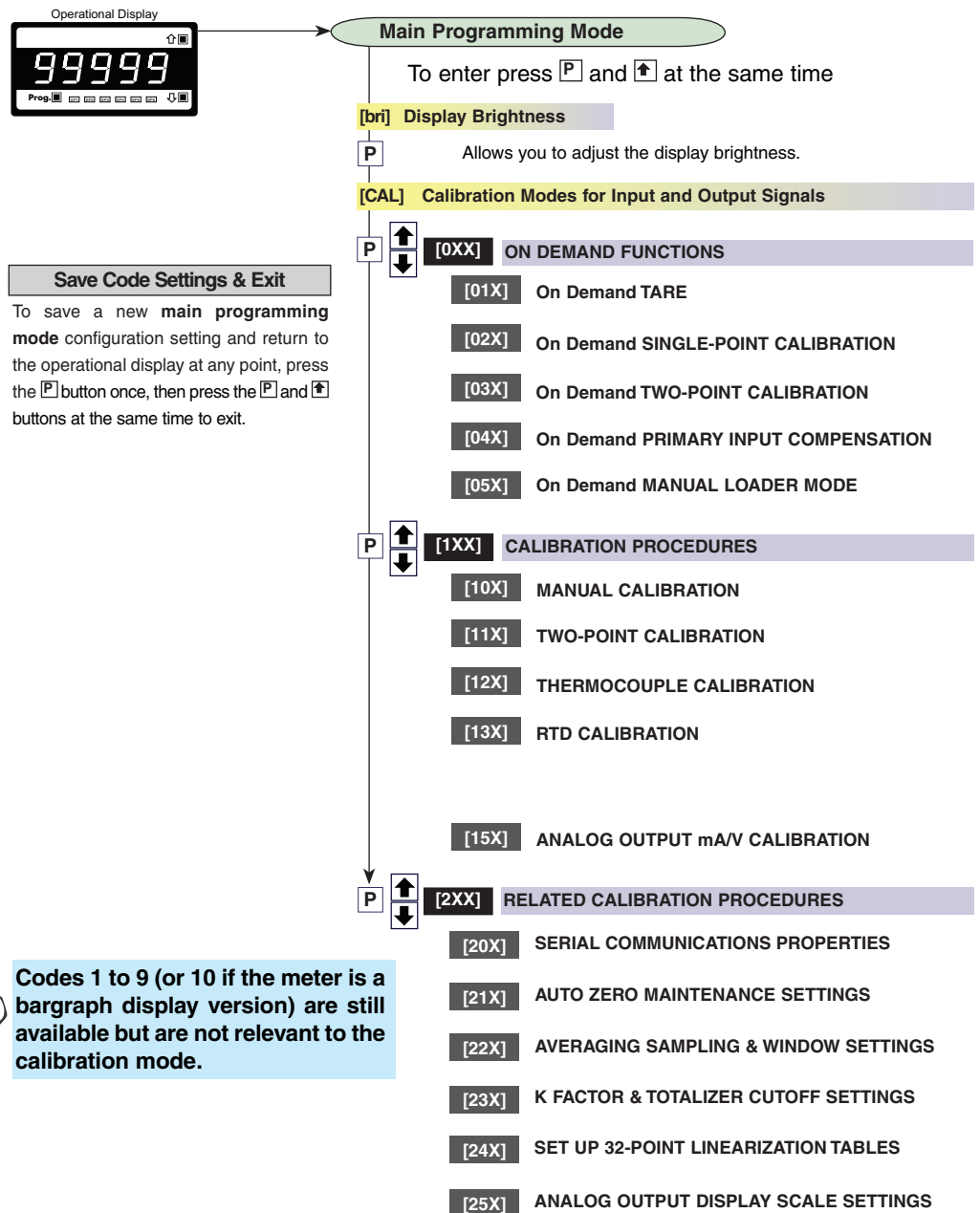

Figure 1 – Calibration Mode Programming Code List

## Calibration Mode

When in the calibration mode, the meter uses the three right-hand side display digits to select the required calibration functions for configuration. These are known as the 1st, 2nd, and 3rd digits. See *Figure 2*.

Alternately, if the meter is connected to a PC through the serial port, all calibration functions can be configured using the Meter Configuration Utility Program.

See *Meter Configuration Utility Program Supplement (NZ206)* for details.

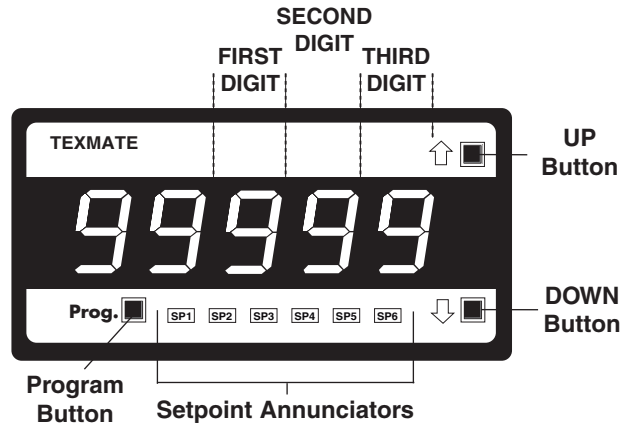

Figure 2 – Meter Programming Digits for Calibration Mode Functions

## Calibration Mode Programming Codes

See the Calibration Mode Programming Codes diagram opposite for a partial breakdown of the the calibration mode. See Programming Code Sheet (NZ101) for a complete breakdown of these codes.



*Note:*

The default settings for the 1st, 2nd, and 3rd digits are displayed in **bold text**.

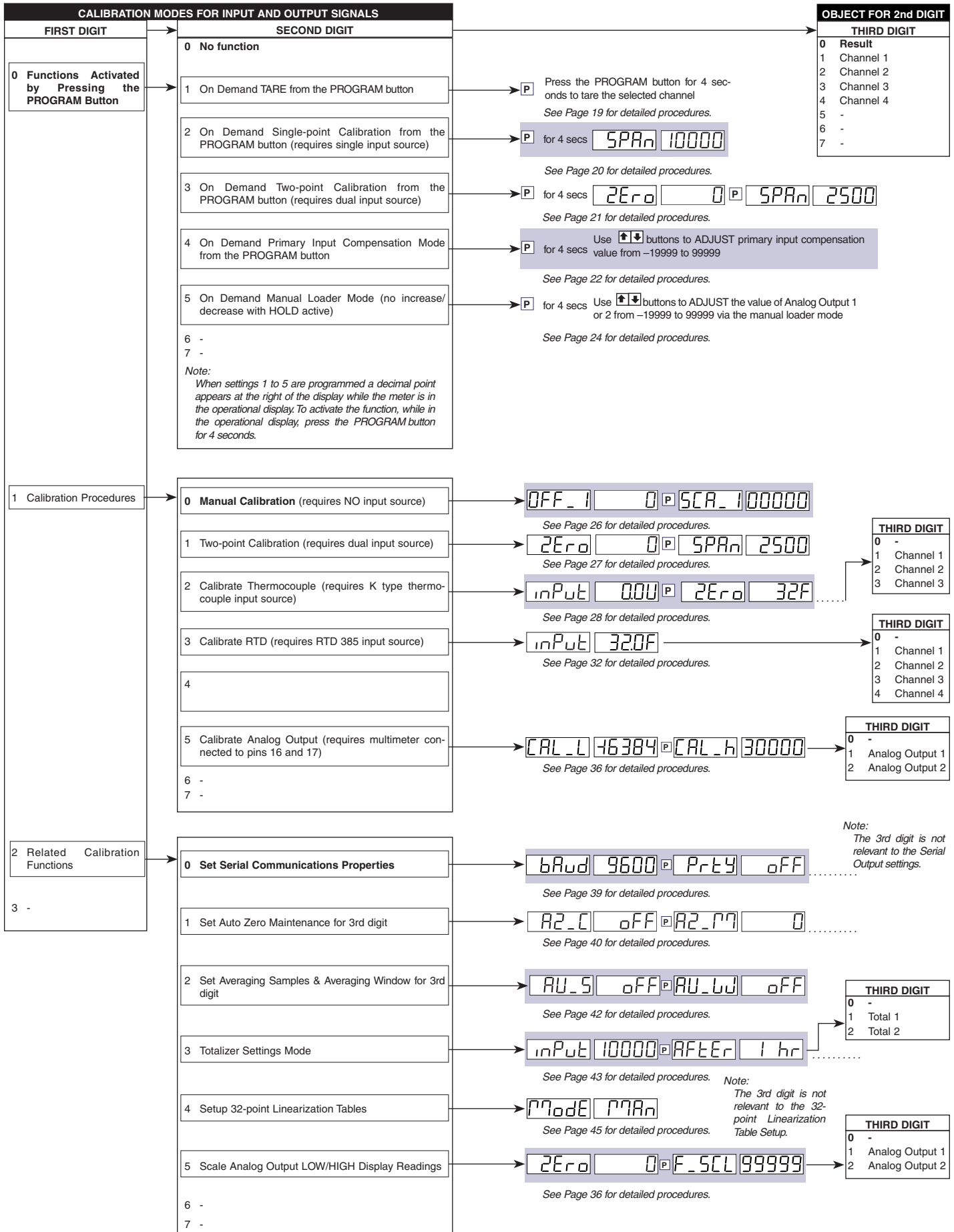

# Technical Description

The calibration mode is divided into three main areas of calibration.

## ON DEMAND Functions

On demand functions are functions activated by pressing and holding the PROGRAM button for 4 to 5 seconds after the required function has been configured in the calibration mode. This mode is suitable for many applications where end users often need to:

- Calibrate the meter at regular intervals.
- Manually enter input compensation values.
- Manually adjust analog output signal values for control purposes.



*Note:*

See Figure 3.

The following calibration procedures can not be carried out on a signal (Result, or CH1 to CH4) if the signal has an active linearization table. The table or tables must be disabled before calibration and then re-activated when calibration is complete:

- On demand single-point calibration.
- On demand two-point calibration.
- Manual calibration.
- Two-point calibration.

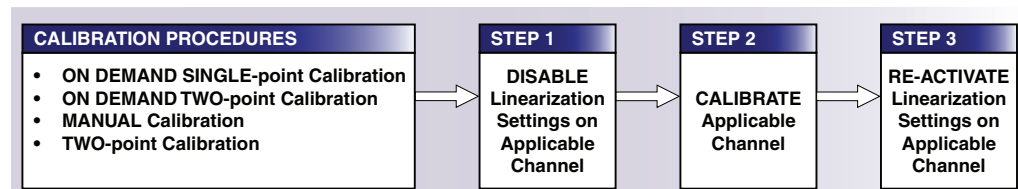

Figure 3 – Linearization Table De-activate/Re-activate Process

## Input and Output Signal Calibration Procedures

This is the mode where the meter's input and output signals are calibrated prior to application configuration. Depending on the input signal conditioning and analog output modules installed, up to four input signals and two analog output signals can be calibrated.

The following input/output calibration procedures are available:

- Manual Calibration.
- Two-point Calibration.
- Thermocouple Calibration.
- RTD Calibration.
- Analog Output Signal Calibration.

## Related Calibration Procedures

This mode covers the following related calibration functions:

- All serial communications properties for the serial output signal.
- Auto zero maintenance settings for load cell / weighing applications.
- Input signal averaging sample and averaging window settings.
- Totalizer settings mode for configuring totalizer 1 and totalizer 2.
- Setup of 32-point linearization tables.
- Analog output signal scale settings.

# On Demand Functions

All on demand functions are accessed by setting the 1st digit in the calibration mode to 0 [CAL] [0XX].

The 2nd digit selects one of the following on demand functions:

- On Demand Tare [01X].
- On Demand Single-point Calibration [02X].
- On Demand Two-point Calibration [03X].
- On Demand Primary Input Compensation [04X].
- On Demand Manual Loader Mode [05X].

The 3rd digit selects the required object to be programmed for on demand activation and depends on the on demand function selected.

## On Demand Tare

On demand tare is used for weighing applications or when the meter is required to display a % deviation from a primary value.

Setting the 1st and 2nd digits to [01X] selects the **on demand tare** function.

By selecting a number in the 3rd digit, tare can be programmed to activate on demand for one of the following signals:

- Result [010].
- Channel 1 [011].
- Channel 2 [012].
- Channel 3 [013].
- Channel 4 [014].

*See Calibration Mode Programming Codes on Page 5.*

*See Page 19 for detailed procedures.*

## On Demand Single-point Calibration

This procedure is used where only the span (HIGH input signal) setting requires adjusting to a calibrated value. For example, optical sensors or pH meters with one known solution.

Setting the 1st and 2nd digits to [02X] selects the **on demand single-point calibration** procedure.

By selecting a number in the 3rd digit, single-point calibration can be programmed to activate on demand and calibrate one of the following signals:

- Result [020].
- Channel 1 [021].
- Channel 2 [022].
- Channel 3 [023].
- Channel 4 [024].

*See Figure 4.*

*See Calibration Mode Programming Codes on Page 5.*

*See Page 20 for detailed procedures.*

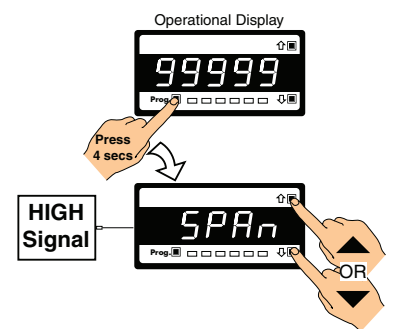

**Figure 4 – On Demand Single-point Calibration**

## On Demand Two-point Calibration

This procedure is used where a LOW and HIGH input signal value needs to be adjusted.

Setting the 1st and 2nd digits to [03X] selects the **on demand two-point calibration** procedure.

By selecting a number in the 3rd digit, two-point calibration can be programmed to activate on demand and calibrate one of the following signals:

- Result [030].
- Channel 1 [031].
- Channel 2 [032].
- Channel 3 [033].
- Channel 4 [034].

See Figure 5.

See Calibration Mode Programming Codes on Page 5.

See Page 21 for detailed procedures.

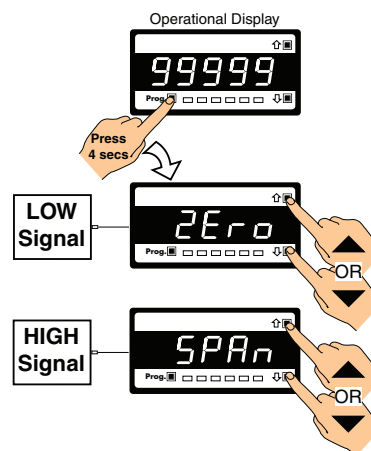

Figure 5 – On Demand Two-point Calibration

## On Demand Primary Input Compensation

On demand primary input compensation is used where measurement applications require an operator entered programmable offset.

Fluctuations on an input signal due to changes in the process conditions pressure, temperature are compensated for by manual adjustment.

This function allows the operator to use the UP and DOWN buttons increase or decrease the primary input signal (normally programmed for CH1) through a secondary channel (normally CH2). The primary and secondary channels are processed and the resultant display shows a signal compensated for variations to the primary input signal.

When the PROGRAM button is pressed for 4 to 5 seconds during normal operation, the compensation offset amount can be adjusted. If the meter has been configured for channel 1 (CH1) plus channel 2 (CH2), entering a positive value **increases** the compensation offset amount. If the meter has been configured for CH1 minus CH2, entering a positive value **decreases** the compensation offset amount.

Setting the 1st and 2nd digits to [04X] selects **on demand primary input compensation**.

By selecting a number in the 3rd digit, primary input compensation can be programmed to activate on demand and compensate the signal on one of the following signals:

- Channel 1 [041].
- Channel 2 [042].
- Channel 3 [043].
- Channel 4 [044].

See Figure 6.

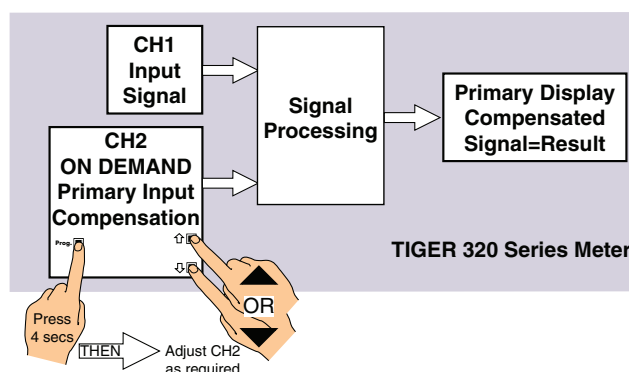

Figure 6 – On Demand Primary Input Compensation



The meter is usually configured so that:

- The display is set up in Code 1 to [X50] to display the result of CH1 and CH2 (CH2 added to CH1, or CH2 subtracted from CH1).
- The input signal is via CH1 and set up in Code 2.
- The compensation value is entered in CH2, which is set up in Code 4 to [000].
- Processing the result is set up in Code 7 to either [003] for CH1 plus CH2, or [004] for CH1 minus CH2.
- The primary input compensation function is activated by setting the calibration mode to [042].

See *Calibration Mode Programming Codes on Page 5*.

See *Pages 22 and 23 for detailed procedures*.

---

## On Demand Manual Loader Mode

The meter can be programmed for precise and repeatable manual control from the digital display via the analog output. This is known as the **manual loader mode**.

The meter is configured so that the display (in engineering units) accurately relates to the analog output. The analog output is adjusted using the UP and DOWN buttons on the front panel.

Setting the 1st and 2nd digits to [05X] selects the **on demand manual loader mode**.

By selecting a number in the 3rd digit, either [051] or [052], the manual loader mode is programmed to activate on demand (by pressing the PROGRAM button for 4 to 5 seconds) and adjust one of the following analog output signals:

- Analog Output 1 [051].
- Analog Output 2 [052].

The analog output via the manual loader mode can be used to control valves, motor speed, gate position, or any control unit requiring precise manual control using a 0-10 V or 0/4-20 mA input.

The analog output can be locked by connecting the COMMON pin (pin 11) and the HOLD pin (pin 9) at the rear of the meter. See *Figure 7*.

Before configuring the meter as an on demand manual loader:

- Make sure the ANALOG OUTPUT SELECTION HEADER is correctly selected for the output signal type: volts or milliamps.

See *Analog Output Module Supplement (NZ200) for details*.

- Connect a multimeter to pins 16 and 17 on the meter's analog output connector block.
- Scale and calibrate the analog output using the multimeter.

See *Analog Output Calibration Procedure on Page 36 for details*.

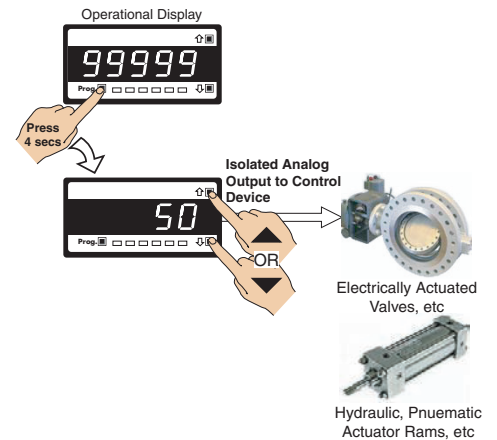

**Figure 7 – On Demand Manual Loader Mode**

- Connect pins 16 and 17 on the meter's analog output connector block to the control equipment.
- Enter Code 1 of the meter's main programming mode:
  - Set to [X54]. Select [DiSP] as the source of data for the **analog output**.
  - Reset Code 1 to [X50]. Select CH1 as the source of data for the **primary display**.
- Enter the calibration mode [CAL] of the meter's main programming mode and set the 1st and 2nd digits to [05X]. To select **on demand manual loader mode** for **analog output 1** or **analog output 2**, set in the 3rd digit to:
  - [X51] = Analog Output 1.
  - [X52] = Analog Output 2 (under development).

See *Calibration Mode Programming Codes on Page 5*.

See *Pages 36 to 38 for detailed procedures*.

# Input & Output Signal Calibration Procedures

All calibration procedures are accessed by setting the 1st digit in the calibration mode to 1 [CAL] [1XX].

The 2nd digit selects one of the following calibration procedures:

- Manual Calibration [10X].
- Two-point Calibration [11X].
- Thermocouple Calibration [12X].
- RTD Calibration [13X].
- Analog Output Milliamp/Voltage Calibration [15X].

The 3rd digit selects the required input type to be calibrated and depends on the calibration procedure selected in the 2nd digit.

## Manual Calibration

The manual calibration procedure is used for manual adjustment of calculated zero offset and scale factor values. This procedure requires NO input source.

Setting the 1st and 2nd digits to [10X] selects the **manual calibration procedure**.

Selecting a number in the 3rd digit calibrates one of the following signals:

- Result [100].
- Channel 1 [101].
- Channel 2 [102].
- Channel 3 [103].
- Channel 4 [104].

*See Calibration Mode Programming Codes on Page 5.*

*See Page 26 for detailed procedures.*

## Two-point Calibration

The two-point calibration procedure is used where LOW and HIGH signal values require adjusting.

Setting the 1st and 2nd digits to [11X] selects the **two-point calibration procedure**.

Selecting a number in the 3rd digit calibrates one of the following signals:

- Result [110].
- Channel 1 [111].
- Channel 2 [112].
- Channel 3 [113].
- Channel 4 [114].

*See Figure 8.*

*See Calibration Mode Programming Codes on Page 5.*

*See Page 27 for detailed procedures.*

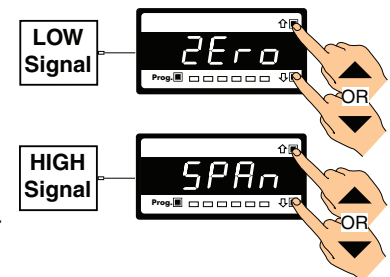

Figure 8 – Two-point Calibration

## Thermocouple Calibration

This is an initial thermocouple calibration mode using a K type thermocouple source as a reference and is suitable for all thermocouple types. For increased accuracy, the manufacturer recommends that further calibration using the two-point calibration procedure and inputting a LOW and HIGH signal for the required thermocouple type should be carried out.

Before calibration, configure the meter for a K type thermocouple for the required channel:

- For CH1 enter Code 2 and select [X11].
- For CH2 enter Code 4 and select [11X].
- For CH3 enter Code 5 and select [X21].
- For CH4 enter Code 6 and select [021].

Connect a temperature simulator using a connector of the required thermocouple type to the input module terminal pins (normally pins 1 and 2, or 1 and 3).

*See I-Series Input Module Supplement for connection details.*

Short the input at the terminal pins to simulate a 0.0 V reference signal.

Enter the calibration mode. Setting the 1st and 2nd digits to [12X] selects the **thermocouple calibration procedure**.

By selecting a number in the 3rd digit one of the following signals can be calibrated:

- Result [120].
- Channel 1 [121].
- Channel 2 [122].
- Channel 3 [123].
- Channel 4 [124].

Carry out an initial calibration of the thermocouple input on the selected channel. The meter applies a 0.0 V internal reference signal. When complete, remove the short across the input module terminals. Continue and apply a 32 °F and then a 2500 °F input to the meter.

Enter the programming code for the selected channel and select the required thermocouple type. For example, an S type thermocouple for CH1 would be set up as [X13] in Code 2.

Decide on the measurement system required: °F or °C. As standard, the meter is configured in °F. If °C is required, convert the display to °C.

Enter the calibration mode again and calibrate the selected channel for the required thermocouple type by applying a LOW and HIGH input signal in the relevant measurement system.

*See Figure 9.*

*See Calibration Mode Programming Codes on Page 5.*

*See Page 28 for detailed procedures.*

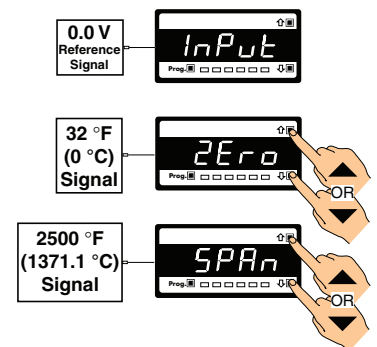

**Figure 9 – Thermocouple Calibration**

---

## RTD Calibration

This is an initial RTD calibration mode using a type 385 RTD source as a reference and is suitable for all RTD types. For increased accuracy, the manufacturer recommends that further calibration using the two-point calibration procedure and inputting a LOW and HIGH signal for the required RTD type should be carried out.

Before calibration, configure the meter for RTD type 385 for the required channel:

- For CH1 enter Code 2 and select [X21] or [X31].  
Note: the second digit must be set to suit the RTD type:
  - 3-wire = [X21].
  - 2/4-wire = [X31].
- For CH2 enter Code 4 and select [21X].
- For CH3 enter Code 5 and select [X31].
- For CH4 enter Code 6 and select [X31].

If using input module models IT03 / IT04 / IT05 make sure the header is set to the correct position for 3-wire or 2/4-wire applications.

Connect a temperature simulator using a connector of the required RTD type to the input module terminal pins (normally pins 1 and 2, or 1 and 3).

See *I-Series Input Module Supplement* for connection details.

Enter the calibration mode. Setting the 1st and 2nd digits to [13X] selects the **RTD calibration procedure**.

By selecting a number in the 3rd digit one of the following signals can be calibrated:

- Result [130].
- Channel 1 [131].
- Channel 2 [132].
- Channel 3 [133].
- Channel 4 [134].

Carry out an initial calibration of the meter. The meter applies a 32 °F internal reference signal.

Enter the code for the selected channel and select the required RTD type. For example, a type 120 3-wire RTD for CH1 would be set up as [X23] in Code 2.

Decide on the measurement system required: °F or °C. As standard, the meter is configured in °F. If °C is required, convert the display to °C.

Enter the calibration mode again and calibrate the selected channel for the required RTD type by applying a LOW and HIGH input signal in the relevant measurement system.

See *Figure 10*.

See *Calibration Mode Programming Codes* on *Page 5*.

See *Page 32* for detailed procedures.



Figure 10 – RTD Calibration

---

## Analog Output Calibration & Scaling

Analog output calibration is a two part procedure covering scaling and calibration. The output calibration part of the procedure can be changed independently of the scaling part and vice versa.

### Scaling

Scaling requires setting the zero [ZErO] and full scale [F\_SCL] span parameters of the analog output.

Zero is the display setting at which the analog output is required to be at its calibrated **low** output. Full scale is the display setting at which the analog output is required to be at its calibrated **high** output.

There are no limits to the difference between the zero and full scale settings. The difference can be anywhere between 1 count and the entire display range of the meter.

Setting the 1st and 2nd digit to 25 [CAL] [25X] accesses the **analog output signal span scaling procedure**.

By selecting a number in the 3rd digit, one of the following analog output signals are available for scaling:

- Analog Output 1 [251].
- Analog Output 2 [252] (under development).

---

### Calibration

Calibrating the analog output means ensuring the LOW and HIGH analog output signals are correct using a calibration device such as a multimeter.

Calibration requires setting the [CAL\_L] and [CAL\_h] parameters. [CAL\_L] is used to set the calibrated **low** analog output, and [CAL\_h] is used to set the calibrated **high** analog output. The calibrated low and high outputs can be set anywhere between  $-0.3$  to 21 mA for current, or  $-0.3$  to 10.5 V for voltage.

Before calibrating the analog output:

- Select the data source for the selected analog output in Code 1.
- Set the ANALOG OUTPUT SELECTION HEADER to the appropriate position (VOLTAGE or CURRENT).
- Connect a multimeter to the analog output connector at the rear of the meter (pin 16 positive, pin 17 negative).
- Make sure the multimeter is set to read the appropriate signal type: volts or milliamps.

Enter the calibration mode and calibrate the analog output module.

Setting the 1st and 2nd digits to [15X] selects the **analog output calibration procedure**.

By selecting a number in the 3rd digit, one of the following analog output signals are available for calibration:

- Analog Output 1 [151].
- Analog Output 2 [152] (under development).

See Figure 11.

See Calibration Mode Programming Codes on Page 5.

See Pages 36 to 38 for detailed procedures.

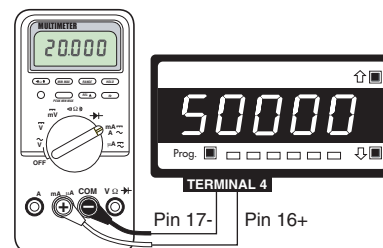

Figure 11 – Multimeter to Meter Connections

# Related Calibration Functions

All other related calibration functions are accessed by setting the 1st digit in the calibration mode to 2 [CAL] [2XX]:

- Serial Output Module Settings.
- Auto Zero Maintenance Settings.
- Totalizer Settings.
- 32-point Linearization Table Settings.
- Analog Output Scale Settings.

---

## Serial Communications Properties

Setting the 2nd digit to 0 [CAL] [20X] accesses the serial communications output module communications properties.

### **Baud Rate**

The baud rate range is selectable from 300 to 19200. The default baud rate is 9600.

### **Parity**

Parity can be set to [oFF], [odd], or [EVEn]. The default parity setting is [oFF].

### **Address**

For RS-485 serial communications the default address setting is 1, but can be set to anywhere between 1 and 255.

### **Transmit Time Delay**

The transmit time delay restricts the meter from transmitting a reply to a slow or busy master device (PC, PLC, etc.) by providing time delays of 2, 20, 50, or 100 milliseconds for all serial modes except ASCII (Code 3 set to XX0). The ASCII Mode uses message terminating characters: \* = 2 ms and \$ = 50 ms.

*See Calibration Mode Programming Codes on Page 5.*

*See Pages 39 and 40 for detailed procedures.*

---

## Auto Zero Maintenance Settings

Setting the 2nd digit to 1 [CAL] [21X] accesses the auto zero maintenance settings for weighing applications applied to the channel selected in the 3rd digit:

- Result [200].
- Channel 1 [201].
- Channel 2 [202].
- Channel 3 [203].
- Channel 4 [204].

There are three programmable auto zero maintenance settings:

- Auto Zero Capture Band [AZ\_C].
- Auto Zero Motion [AZ\_M].
- Auto Zero Aperture Window [AZ\_A].

## Auto Zero Capture Band

The auto zero capture band [AZ\_C] is the programmable band in counts that the auto zero motion compensates within. This is usually set to a value of, for example, 20 counts.

Slowly adding small weights to the load cell maintains zero until the AZ\_C value is reached, then the meter stops maintaining zero and the true weight is displayed.

## Auto Zero Motion

Auto zero motion [AZ\_M] is the programmable maximum rate of change in counts per second allowable. This is usually set to a low value of, for example, 5 counts.

This means that if changes less than 5 counts per second are added to the meter, the meter auto zeroes. But if 5 counts per second are exceeded, the meter stops auto zeroing and the true weight is displayed.

## Auto Zero Aperture Window

The auto zero aperture window [AZ\_A] is the maximum counts that the zero output can drift before the auto zero maintenance settings [AZ\_C] and [AZ\_M] cease to function (Note: the industry standard is 1.9% of span).

The auto zero aperture window is programmed into the meter to control the maximum zero drift of the load cell. This prevents the auto zero maintenance band from shifting the zero beyond programmed limits and therefore exceeding the span range of the application beyond the linear operating range of the load cell.

See Calibration Mode Programming Codes on Page 5.

See Pages 40 and 41 for detailed procedures.

---

## Averaging Samples / Window Settings

Setting the 2nd digit to 2 [CAL] [22X] accesses windowed averaging. Windowed averaging allows you to average a selected number of input signal samples within a selectable averaging window in display counts applied to the channel selected in the 3rd digit. This allows you the benefit of a stable signal, with fast response to change when required.

The number of input signal samples to average over is selected in the [AV\_S] menu. The size of the averaging window in input signal display counts is selected in the [AV\_W] menu.

While the signal is being monitored by the controller, the averaging window tracks the input signal, looks at the samples, and when it locates a group of samples within the size of the window, averaging takes place. As each new sample comes into the controller, the last sample in the group is dropped off. Provided the sample group remains within the averaging window, the controller constantly averages the sample group.

If a sample moves out of the averaging window, the controller responds quickly to the change by displaying the non-averaged signal value. When the signal stabilises, a new averaging window is established around a sample group and averaging resumes.

The number of samples to average the input signal over can be programmed from 1 to 255 samples. The averaging window can be set to between 1 and 65535 counts.

See Figure 12.

See Calibration Mode Programming Codes on Page 5.

See Page 42 for detailed procedures.

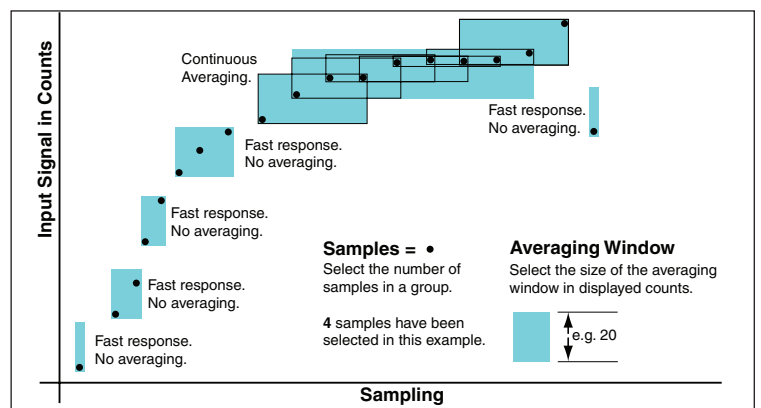

Figure 12 – Input Signal Sampling Showing Averaging Window

---

## Totalizer Settings

For the totalizer to perform the K factor calculations and provide a total, the following settings must be programmed into the meter in the **totalizer settings mode** of the calibration mode. To enter the totalizer settings mode, enter the calibration mode and select [23X].

Selecting **2** in the 1st digit selects **related calibration functions**, selecting **3** in the 2nd digit selects the **totalizer settings mode**. Select **1** in the 3rd digit to select **totalizer 1** or **2** to select **totalizer 2**.

Entering the totalizer settings mode allows you to configure the following settings for the selected totalizer:

- Input Rate.
- Running Time.
- Required Total.
- Cutoff.
- Rollover.

### **Input Rate**

The input rate has a default setting of 10,000 counts. This can be adjusted to suit the known input rate of an application.

So, using our 350 GPM flow rate example, to display in units of 1 gallon we can adjust the input rate from 10,000 counts to 350 counts. Or, if we wanted to display the total in tenths of a gallon, we can adjust the input rate to 3500 counts, making sure the totalizer resolution is set for tenths (0.1). This gives us a display of 350.0 for 350 GPM.

### **Running Time**

The running time is the period over which the input rate is accumulated in the totalizer. The following running times are selectable in the meter:

### **Total Required**

This is the total you wish to see after a selected running time. The **unit input rate** is normally selected as the running time.

So once again, using our 350 GPM flow rate, the unit input rate is gallons per minute. This means that when we set the required **total**, it is with the understanding that the total is expressed as a unit of gallons per minute. For example:

If we wish to display 1 kilogallon for every 1,000 gallons totalled, we would set the required **total** to **1**.

But, if we wanted the totalizer to display to the nearest 100 gallons, we would have to move the decimal point to add an extra unit. Therefore, instead of setting the required **total** as **1**, we would set it to **10**. The 1,000 gallons would then display as 1.0 on the totalizer as long as the input signal resolution is set to 0.1 (tenths).

### **Cutoff**

This is normally set to 0 to prevent counts being subtracted from the total, but it can be set anywhere from -19999 to 32767 counts, depending on the application.

### **Rollover**

When set to ON, rollover automatically resets the total to 0 when the total value exceeds the maximum count possible on the display (99,999 for 5-digit, 999,999 for 6-digit, and 99,999,999 for 8-digit meters). It resets the totalizer to 0, but does not increment any other register to record the rollover.

*See Calibration Mode Programming Codes.*

*See Page ?? for detailed procedures.*

*See Totalizing Supplement (NZ208) for full details.*



---

## 32-point Linearization Table Settings

This is the mode for configuring all available linearization tables.

Setting the 2nd digit in the calibration mode to 4 [CAL] [24X] accesses the **setup 32-point linearization tables mode**. Depending on the options selected during purchasing, the meter has either 1 or 4 linearization tables available.

There are two modes available to configure the linearization tables: auto setup mode or manual setup mode.

### **Auto Setup Mode**

The **auto setup mode** allows a sensor output to be directly applied to the meter. The corresponding data is entered into the selected linearization table and stored in the meter.

### **Manual Setup Mode**

The manual setup mode allows known or calculated values to be entered into a selected linearization table and stored in the meter.

### **Initialize Mode**

All four linearization tables are programmed into the meter at the factory with a default straight line. Selecting the initialize mode [init] re-initializes a reconfigured linearization table back to the default settings. Select the table to be re-initialized, adding the correct date and serial number if applicable, and then press the PROGRAM button. Reset CAL to [000].

### **Linearization Table Identity**

As a reference, the table number, the date, and a serial number can be entered before the linearization points in either mode. See *Figure 13*.

#### **Table Number**

If the four table option was selected during purchasing, any table from 1 to 4 can be selected for setup. Tables 1 to 4 are available for use with channel 1 and channel 2. Channels 3 and 4 use Table 1 only.

#### **Date**

A date displaying the year and week the linearization table was set up can be added to each table.



#### **Serial Number**

A serial number using up to five digits from 0 to 65535 can be set for each table. **Figure 13 – Linearization Table Date Setup**

### **Applying a Selected Table to a Channel**

Applying the linearization table or tables to a particular channel or the result is set up in one of the following codes in the main programming mode:

- **For CH1 select Code 3.**

Selecting one of the following numbers in the 2nd digit of Code 3 applies the selected linearization table to CH1:

- 1 32-point Linearization on CH1 using Table 1.
- 2 32-point Linearization on CH1 using Table 2.
- 3 32-point Linearization on CH1 using Table 3.
- 4 32-point Linearization on CH1 using Table 4.
- 5 125-point Linearization on CH1 (Tables 1 to 4 cascaded).
- 6 32-point Linearization on CH1 (Tables 1 to 4 selected from the rear pins of selected input modules).

- **For CH2 select Code 4.**  
Selecting one of the following numbers in the 3rd digit of Code 4 applies the selected linearization table to CH2:
  - 1 32-point Linearization on CH2 using Table 1.
  - 2 32-point Linearization on CH2 using Table 2.
  - 3 32-point Linearization on CH2 using Table 3.
  - 4 32-point Linearization on CH2 using Table 4.
  - 5 125-point Linearization on CH2 (Tables 1 to 4 cascaded).
- **For CH3 select Code 5.**  
Selecting **2** in the 2nd digit of Code 5 and **7** in the 3rd digit applies Linearization Table 1 to CH3.
- **For CH4 select Code 6.**  
Selecting **2** in the 2nd digit of Code 6 and **7** in the 3rd digit applies Linearization Table 1 to CH4.
- **For Result select Code 7.**  
Selecting one of the following numbers in the 2nd digit of Code 7 applies the selected linearization table to the result:
  - 1 32-point Linearization on CH1 using Table 1.
  - 2 32-point Linearization on CH1 using Table 2.
  - 3 32-point Linearization on CH1 using Table 3.
  - 4 32-point Linearization on CH1 using Table 4.
  - 5 125-point Linearization on CH1 (Tables 1 to 4 cascaded).
  - 6 32-point Linearization on CH1 (Tables 1 to 4 selected from the rear pins of selected input modules).

### ***Linearizing Standard Temperature Sensors***

All Tiger meters have a range of pre-programmed linearization tables of standard thermocouple and RTD types for easy selection for channels 1 to 4.

To activate a pre-programmed temperature sensor table, follow the calibration procedures for the required thermocouple or RTD type.

#### **Thermocouple Types**

The following standard thermocouple types are available:

- Type J.
- Type K.
- Type R.
- Type S.
- Type T.
- Type B.
- Type N.
- Type E.

For thermocouple sensors other than those listed, contact the manufacturer.

#### **RTD Types**

The following standard RTD's are available in 3-wire and 2/4-wire types:

- Resistance.
- Type 385.
- Type 392.
- Type 120  $\Omega$ .
- Type Cn 10  $\Omega$ .

*See Calibration Mode Programming Codes on Page 5.*

*See Page 28 to 35 for detailed procedures.*

*See Linearizing Supplement (NZ207) for full details.*

# On Demand Tare Procedures

## Setup Procedure

To configure the meter for the on demand tare mode, carry out the following setup procedure.

**START HERE**

### Step 1

Enter brightness mode

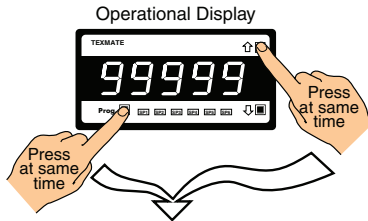

### Step 2

Pass brightness, enter calibration mode

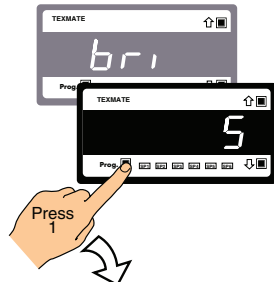

### Step 3

Set calibration mode to [01X]:  
 1st Digit = 0 Functions activated by pressing the PROGRAM button  
 2nd Digit = 1 Selects On Demand TARE  
 3rd Digit = X Selects channel to be tared

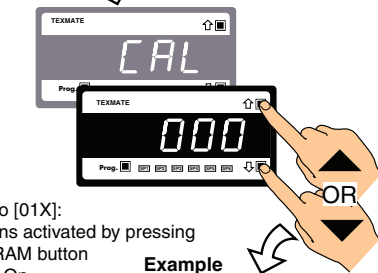

- Example**
- |   |          |
|---|----------|
| 0 | Result   |
| 1 | Type CH1 |
| 2 | Type CH2 |
| 3 | Type CH3 |
| 4 | Type CH4 |
| 5 | -        |
| 6 | -        |
| 7 | -        |

### Step 4

Save calibration mode setting

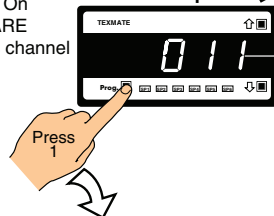

### Step 5

Exit Code 1. Return to operational display

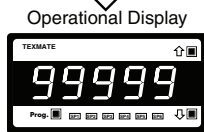
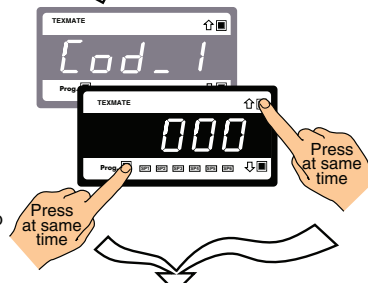

## Activation Procedure

The following example demonstrates the use of the **on demand tare mode** using a basic tare application.

### For Example:

Texmate installed a Tiger DI-50 320 Series meter connected to a weighbridge. The meter is calibrated to read in the appropriate engineering units and configured for the on demand tare mode.

The output from the weighbridge is fed to the meter. The meter is configured to tare the weight of the empty truck on the weighbridge before weighing the truck and its payload. The truck and its payload is then weighed providing a payload weight only.

The weight of the empty truck is 17000 pounds. The nett weight of the load is 8000 pounds. The gross weight of the truck and the load is 25000 pounds ( $25000 - 17000 = 8000$ ).

**START HERE**

### Step 1

Place the empty truck on the weighbridge

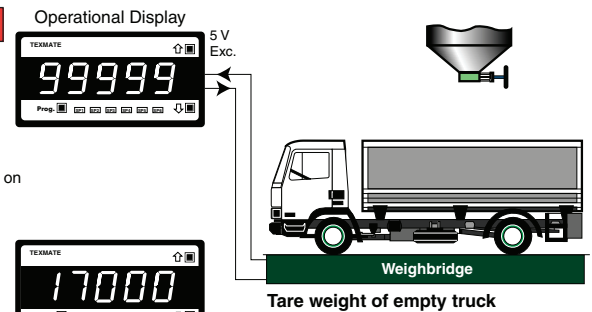

Tare weight of empty truck

### Step 2

Press the PROGRAM button for 4 secs to tare the weight of the empty truck

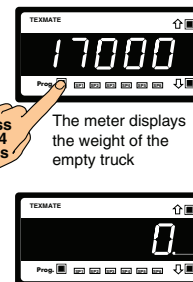

### Step 3

Place the load into the empty truck.

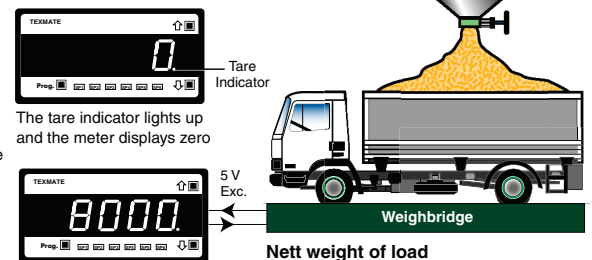

Nett weight of load

### Step 4

Press the UP and DOWN buttons at the same time

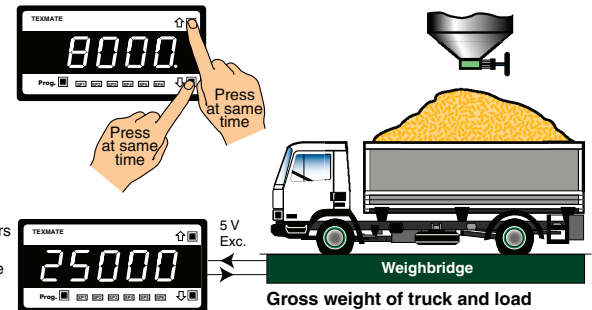

Gross weight of truck and load

The tare function clears and the tare indicator goes out indicating the tare function is not operational.

The meter displays the gross weight of the truck and load



### Note:

Setting tare and resetting tare can be done using external switches.

# On Demand Single-point Calibration Procedures

## Setup Procedure

To configure the meter for **on demand single-point calibration**, carry out the following setup procedure.

**START HERE**

### Step 1

Enter brightness mode

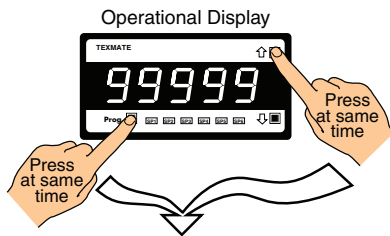

### Step 2

Pass brightness, enter calibration mode

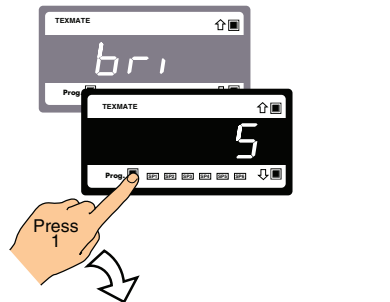

### Step 3

Set calibration mode to [02X]:  
 1st Digit = 0 Functions activated by pressing the PROGRAM button  
 2nd Digit = 2 Selects On Demand Single-point calibration  
 3rd Digit = X Select channel to be calibrated

Example

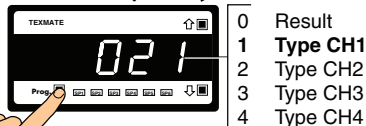

- 0 Result
- 1 Type CH1
- 2 Type CH2
- 3 Type CH3
- 4 Type CH4
- 5 -
- 6 -
- 7 -

### Step 4

Save calibration mode setting



### Step 5

Exit Code 1. Return to operational display

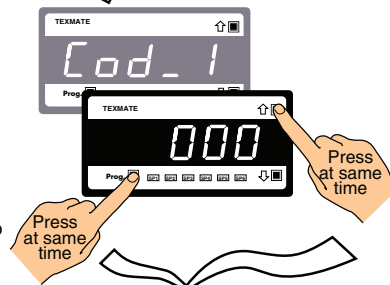

## Activation Procedure

The following example demonstrates the use of the **on demand single-point calibration mode**.

**For Example:**

Calibrate the meter with a SPAN setting (HIGH input) of 5000 counts.

**START HERE**

### Step 1

Press the PROGRAM button for 4 secs to activate the **on demand single-point calibration mode**

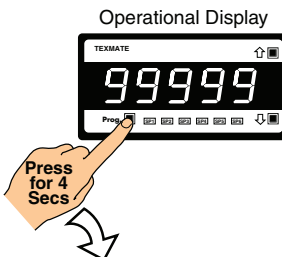

HIGH Signal

Apply the required HIGH input signal to the meter

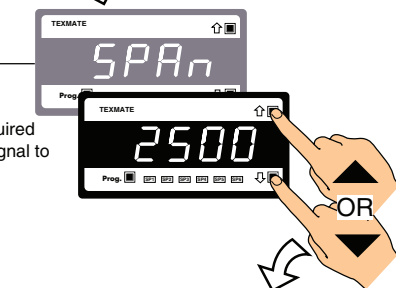

### Step 2

Using the UP and DOWN buttons, adjust the SPAN setting

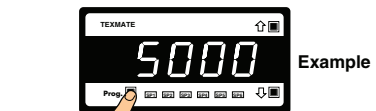

### Step 3

Save the HIGH input signal setting and return to the operational display

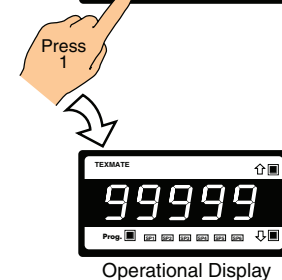

Operational Display

# On Demand Two-point Calibration Procedures

## Setup Procedure

To configure the meter for **on demand two-point calibration**, carry out the following setup procedure.

**START HERE**

### Step 1

Enter brightness mode

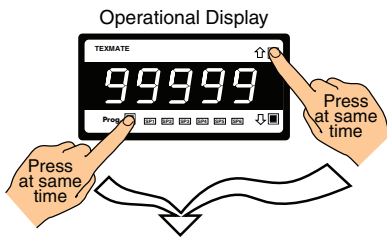

### Step 2

Pass brightness, enter calibration mode

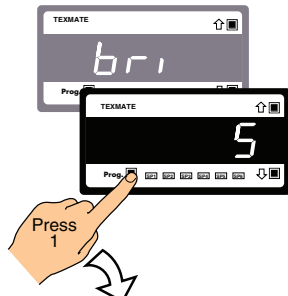

### Step 3

Set CAL Mode to [03X]:  
 1st Digit = 0 Functions activated by pressing the PROGRAM button  
 2nd Digit = 3 Selects On Demand Two-point calibration  
 3rd Digit = X Select channel to be calibrated

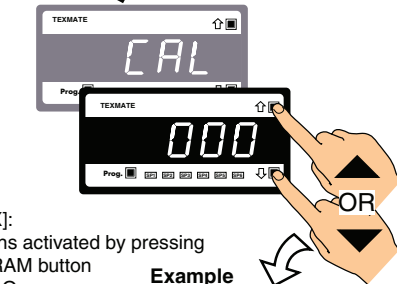

Example

0	Result
1	Type CH1
2	Type CH2
3	Type CH3
4	Type CH4
5	-
6	-
7	-

### Step 4

Save calibration mode setting

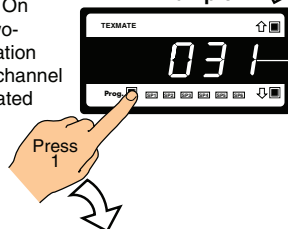

### Step 5

Exit Code 1. Return to operational display

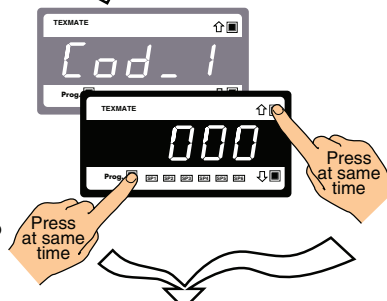

Operational Display



## Activation Procedure

The following example demonstrates the use of the **on demand two-point calibration mode**.

**For Example:**

Calibrate the meter with a ZERO setting (LOW input) of 0 counts and a SPAN setting (HIGH input) of 5000 counts.

**START HERE**

### Step 1

Press the PROGRAM button for 4 secs to activate the **on demand two-point calibration mode**

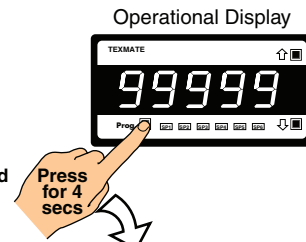

**LOW Signal**

Apply the required LOW input signal to the meter

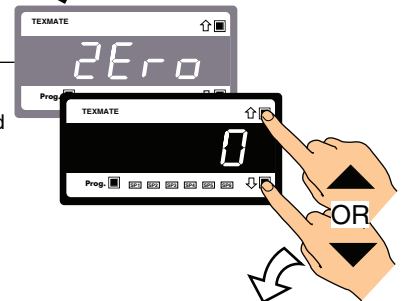

### Step 2

Using the UP and DOWN buttons, adjust the ZERO setting



Example

### Step 3

Save the ZERO input signal setting and enter the SPAN input signal setting menu



**HIGH Signal**

Apply the required HIGH input signal to the meter

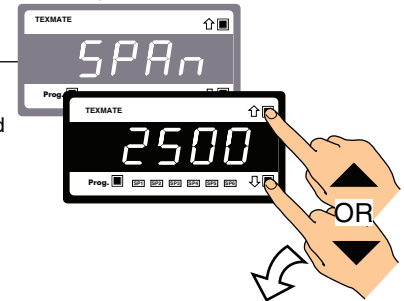

### Step 4

Using the UP and DOWN buttons, adjust the SPAN setting

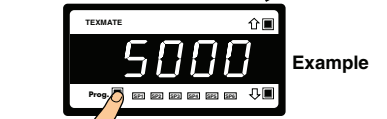

Example

### Step 5

Save the HIGH input signal setting and return to the operational display

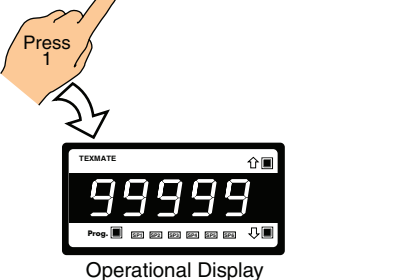

Operational Display

# On Demand Primary Input Compensation Procedures

## Setup Procedure

To configure the meter for **on demand primary input compensation**, carry out the following setup procedure.

**START HERE**

**Step 1**  
Enter brightness mode

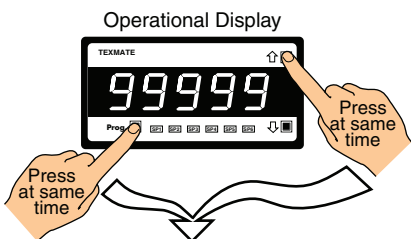

**Step 2**  
Pass brightness, enter calibration mode



**Step 3**  
Set CAL Mode to [04X]:  
1st Digit = 0 Functions activated by pressing the PROGRAM button  
2nd Digit = 4 Selects on demand primary input compensation  
3rd Digit = X Selects channel to be calibrated (Normally CH2)

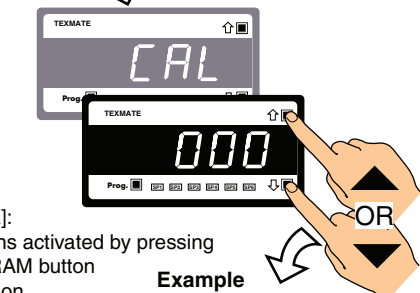

**Step 4**  
Save calibration mode setting

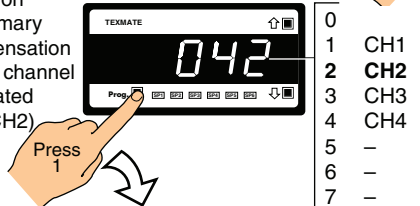

**Step 5**  
Set Code 1 to [X50]:  
1st Digit = X Not relevant  
2nd Digit = 5 Selects data source as per 3rd digit  
3rd Digit = 0 Selects primary display

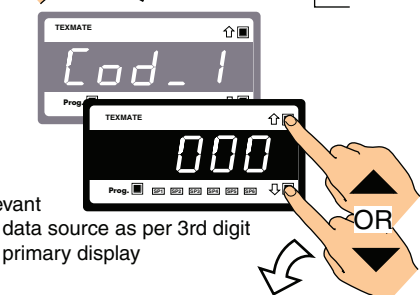

**Step 6**  
Enter the select data source menu

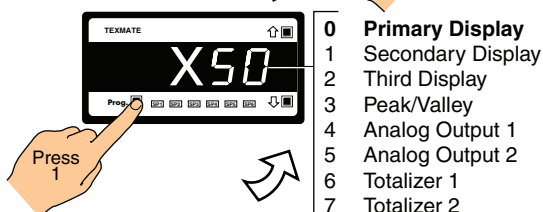

From Step 6

**Step 7**  
Select [rESL] from the list in the **select data source** menu

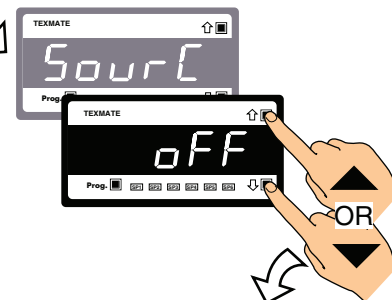

**Step 8**  
Exit the select data source menu and return to Code 1

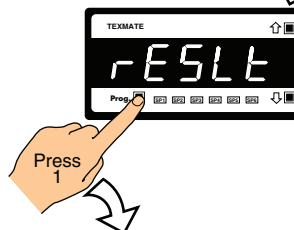

**Step 9**  
Reset Code 1 to [000]

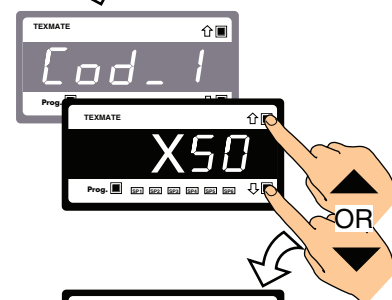

**Step 10**  
Enter Code 2

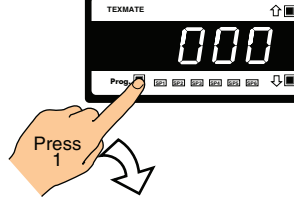

**Step 11**  
Set Code 2 to the measurement task and sampling rate required for CH1 [XXX]:  
1st Digit = X Select the sampling rate for CH1  
2nd Digit = X Select the measurement task type for CH1  
3rd Digit = X Select the specific measurement task for CH1

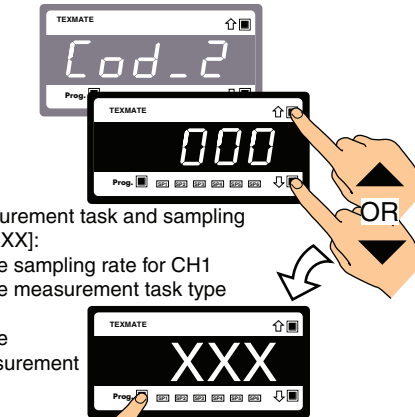

**Step 12**  
Exit Code 2. Pass thru Codes 3 to 6 and enter Code 7.

**On Demand Primary Input Compensation Setup Procedure** continued on next page (Step 13)

From Step 12

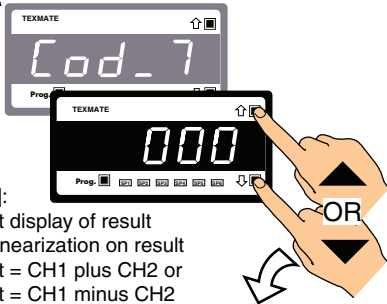

### Step 13

Set Code 7 to [003] or [004]:

- 1st Digit = 0 Selects direct display of result
- 2nd Digit = 0 Selects NO linearization on result
- 3rd Digit = 3 Selects result = CH1 plus CH2 or
- = 4 Selects result = CH1 minus CH2

For CH1 plus CH2



OR

For CH1 minus CH2

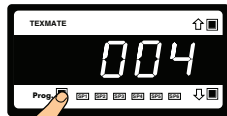

### Step 14

Save settings and Exit Code 7

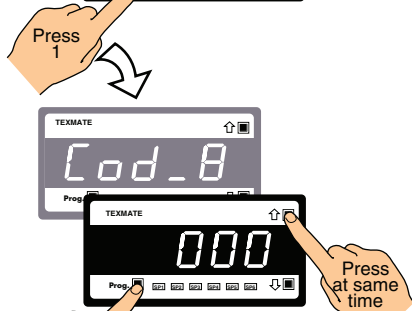

### Step 15

Exit Code 8. Return to operational display

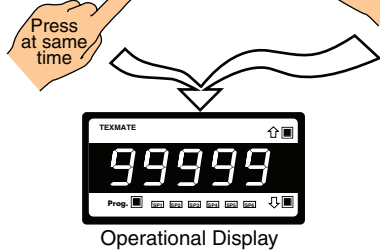

## Activation Procedure

The following example demonstrates the use of the **on demand primary input compensation mode**.

**For Example:**

With the source of the primary display set up as the result of CH1 plus CH2 (Code 1 set to X50, Code 7 set to 003), increase the primary display by 20 counts.

**START HERE**

Operational Display



Example

### Step 1

Press the PROGRAM button for 4 secs to activate the **on demand primary input compensation mode**

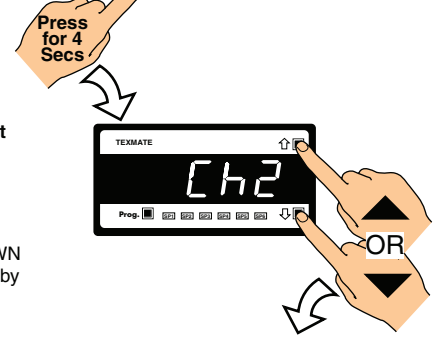

### Step 2

Using the UP and DOWN buttons, increase CH2 by 20 counts

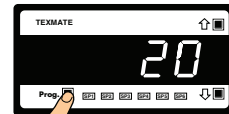

Example

### Step 3

Return to the operational display. The result of CH1 + CH2 = 2020 counts

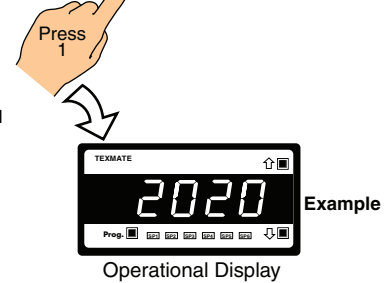



# On Demand Manual Loader Mode Procedures

## Setup Procedure

To configure the meter for **on demand manual loader mode**, carry out the following setup procedure.

**START HERE**

**Step 1**  
Enter brightness mode

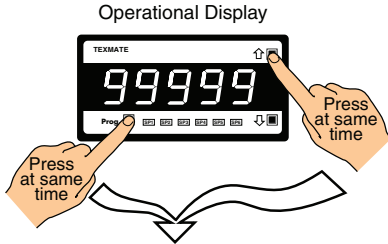

**Step 2**  
Pass brightness and calibration modes and enter Code 1

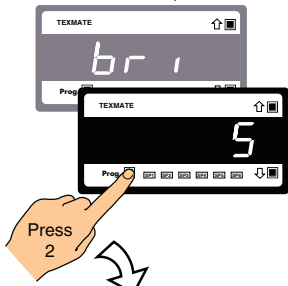

**Step 3**  
Set Code 1 to [X54]  
1st Digit = X Not relevant  
2nd Digit = 5 Selects data source mode  
3rd Digit = 4 Selects analog output 1

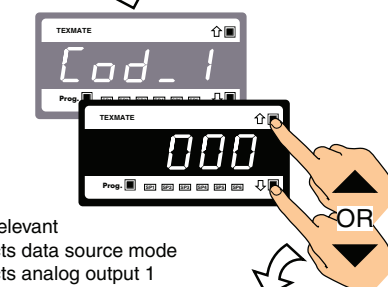

**Step 4**  
Enter the select data source menu

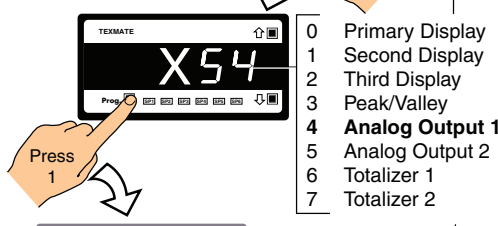

**Step 5**  
Select [Ch2] as the data source for **analog output 1** from the select data source menu. See select data source diagram below for options.

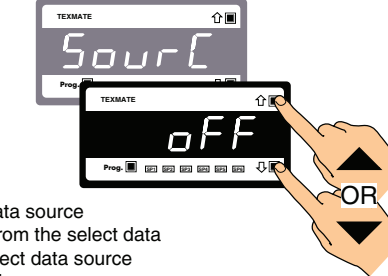

**Step 6**  
Exit the select data source menu

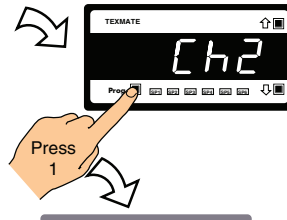

**Step 7**  
Set Code 1 to [X50]  
1st Digit = X Not relevant  
2nd Digit = 5 Selects data source mode  
3rd Digit = 0 Selects primary display

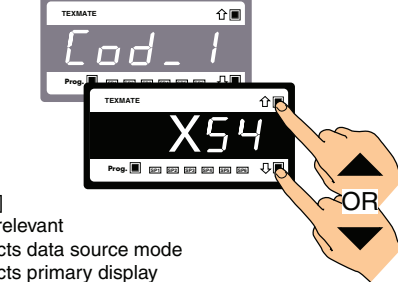

**Step 8**

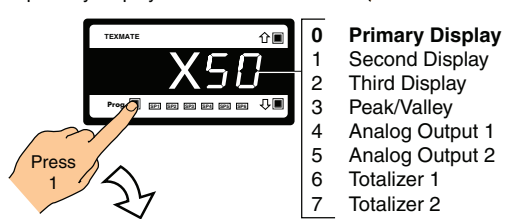

**Step 9**  
Select a channel (CH1 to CH4) as the data source for the **primary display** from the select data source menu. See **select data source** diagram below for options

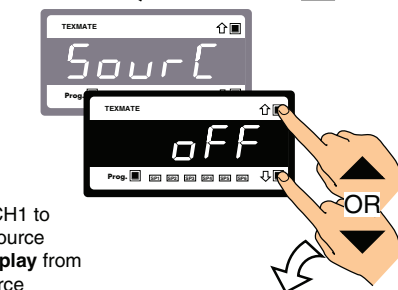

**Step 10**  
Exit the select data source menu

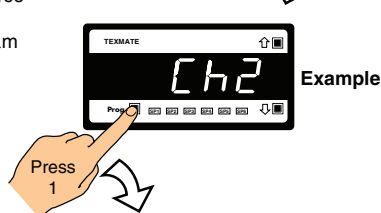

**Step 11**  
Set Code 1 to [X00]  
1st Digit = X Not relevant  
2nd Digit = 0 Selects normal display mode  
3rd Digit = 0 Selects primary display

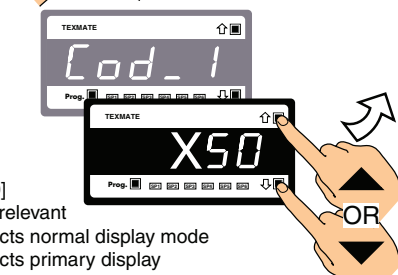

**ON DEMAND MANUAL LOADER MODE Setup Procedure**  
continued on next page

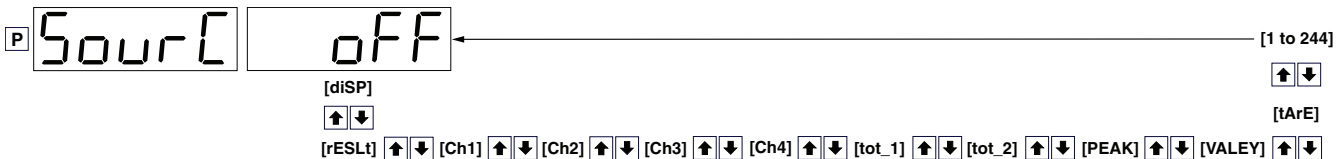



From Step 11

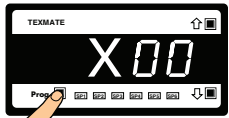

**Step 12**  
Save settings

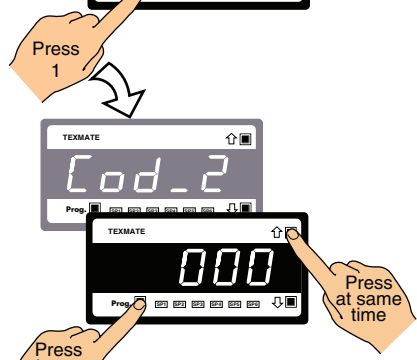

**Step 13**  
Exit Code 2 and return to operational display



**Step 14**  
Return to the main programming mode

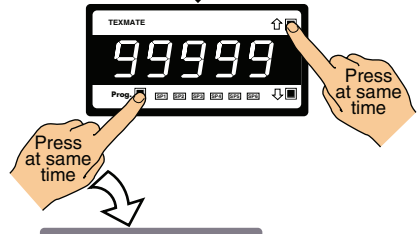

**Step 15**  
Pass brightness and enter calibration mode

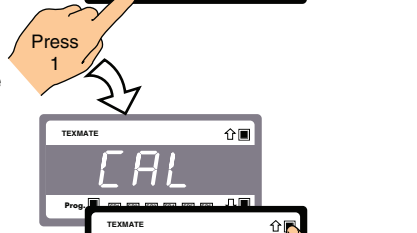

**Step 16**  
Set Code 1 to [05X]:  
1st Digit = 0 Functions activated by Prog. button  
2nd Digit = 5 Selects on demand manual loader mode  
3rd Digit = X Select required channel for on demand manual loader mode

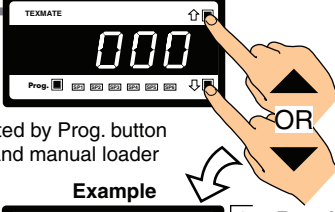

**Example**

0	Result
1	CH1
2	CH2
3	CH3
4	CH4
5	-
6	-
7	-



**Step 17**  
Save settings



From Step 17



**Step 18**  
Exit Code 1 and return to operational display

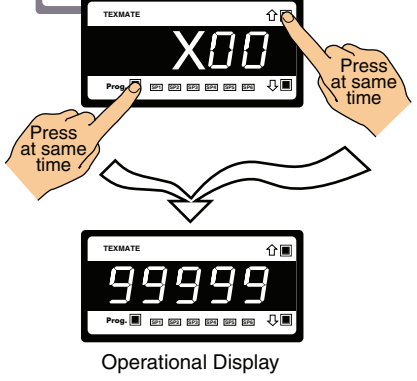

Operational Display

**Activation Procedure**

The following example demonstrates the use of the **on demand manual loader mode**.

**For Example:**

With the source of **analog output 1** set to [Ch2] (Code 1 set to X54), the source of the primary display set to [CH2] (Code 1 set to X50), and CH2 set as the on demand manual loader mode (CAL set to X52), increase the analog output by 20 counts using the manual loader mode.

**START HERE**

Operational Display

Example

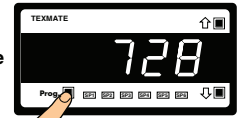

**Step 1**

Press the PROGRAM button for 4 secs to activate the **on demand manual loader mode**

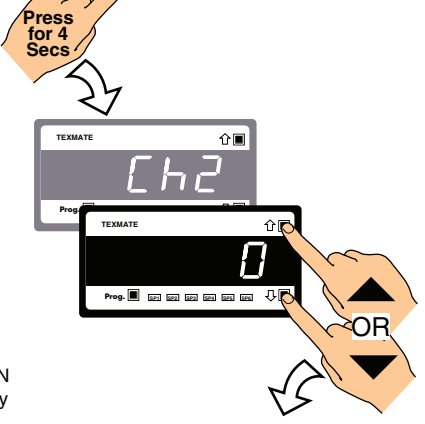

**Step 2**

Using the UP and DOWN buttons, increase CH1 by 20 counts

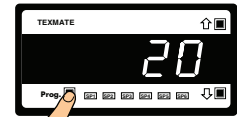

Example

**Step 3**

Return to the operational display. CH1 + 20 counts = 748 counts

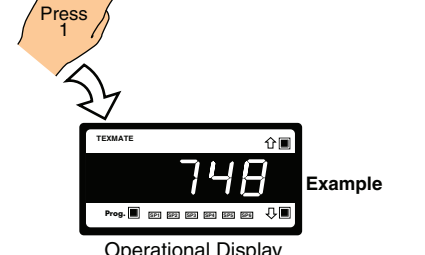

Operational Display

# Manual Calibration Procedure

## Example Procedure

The following example demonstrates the use of the **manual calibration** procedure.

Set CH1 up with an offset setting of 20 and a scale factor setting of 30,000.

**START HERE**

### Step 1

Enter brightness mode

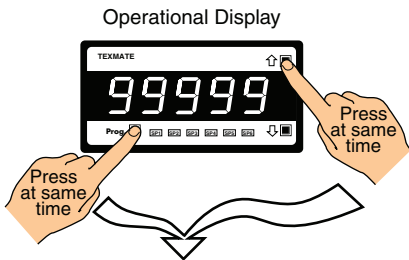

### Step 2

Pass brightness and enter the calibration mode



### Step 3

Set calibration mode to [101]:  
 1st Digit = 1 Selects calibration procedures  
 2nd Digit = 0 Selects manual calibration  
 3rd Digit = 1 Selects CH1

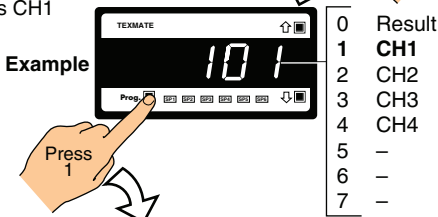

### Step 4

Enter the OFFSET menu



### Step 5

Set the offset to 20

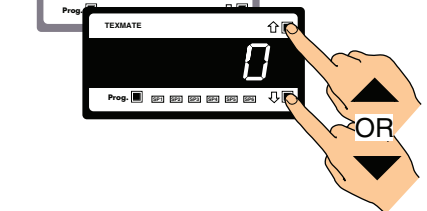

From Step 6



### Step 6

Save the offset setting. Enter the scale factor menu

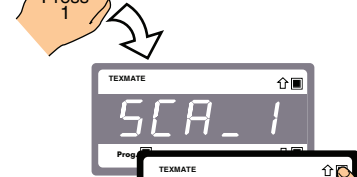

### Step 7

Set the scale factor to [30000]

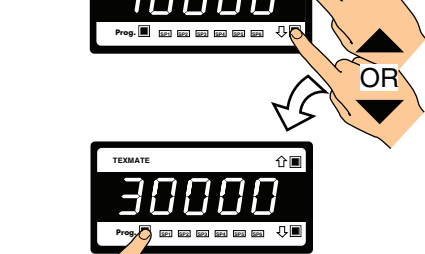

### Step 8

Save the scale factor setting. Enter the Calibration mode

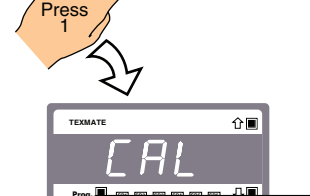

### Step 9

Reset [CAL] to [000]

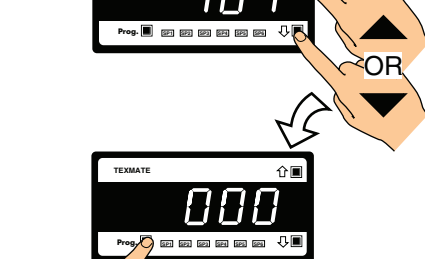

### Step 10

Save settings

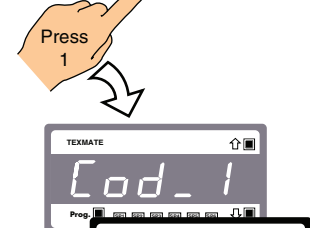

### Step 11

Exit Code 1 and return to operational display

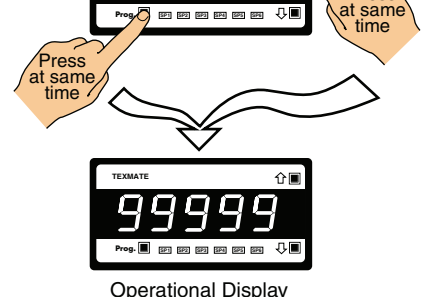

# Two-point Calibration Procedure

## Example Procedure

The following example demonstrates the **two-point calibration** procedure. Set CH1 up with a ZERO setting of 0 and a SPAN setting of 20,000.

**START HERE**

### Step 1

Enter brightness mode

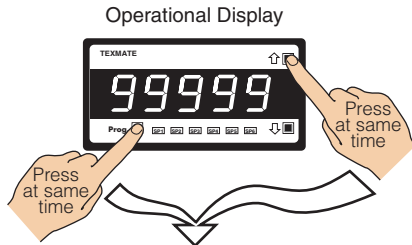

### Step 2

Pass brightness mode and the enter calibration mode

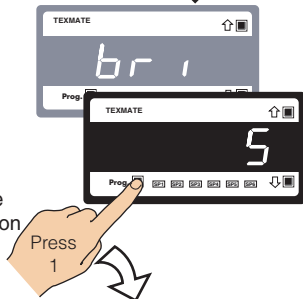

### Step 3

Set calibration mode to [111]:  
 1st Digit = 1  
 Selects calibration procedures  
 2nd Digit = 1  
 Selects 2-point calibration  
 3rd Digit = 1  
 Selects CH1 for calibration

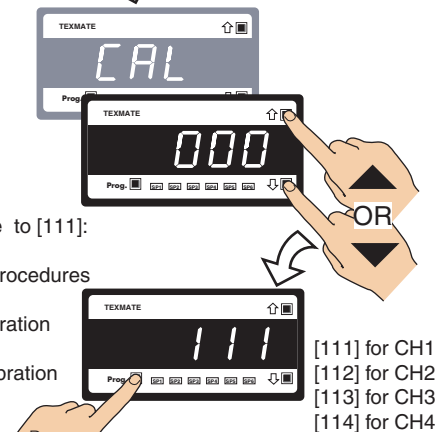

### Step 4

Enter calibration mode [111] for 2-point calibration of CH1



### Step 5

5.1. Adjust display to desired reading for zero input  
 5.2. Apply the LOW input signal

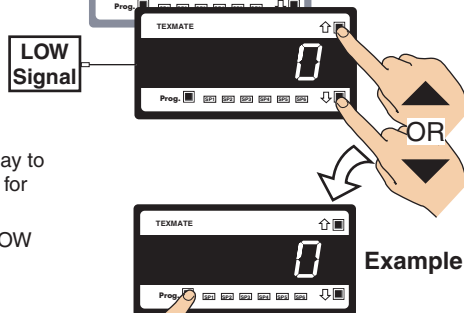

### Step 6

Set reading for zero load into meter and enter span mode



To Step 7

The low input source is applied to the meter when setting the zero value.



The high input source is applied to the meter when setting the span value.



### Step 7

7.1. Adjust display to desired reading for span input

7.2. Apply the HIGH input signal

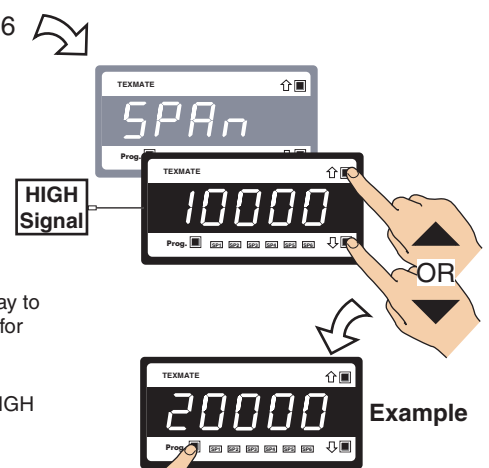

### Step 8

Save zero and span settings and re-enter calibration mode

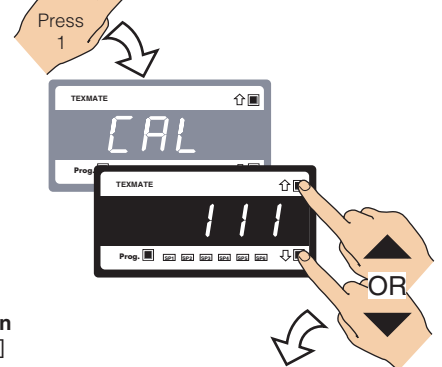

### Step 9

Select the no function calibration mode [000]



### Step 10

Save calibration mode [000] setting and enter Code 1

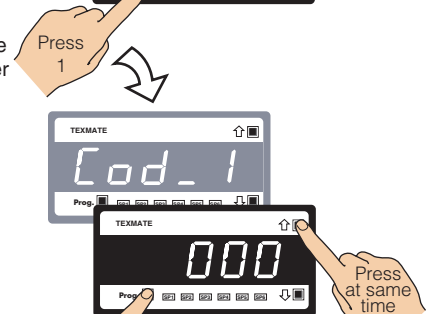

### Step 11

Exit code 1 and return to operational display

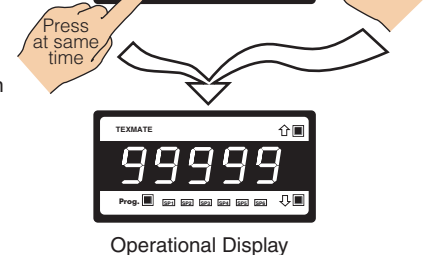

# Thermocouple Calibration Procedures

## Example Procedure

The following example describes how to calibrate channel 1 (CH1) for an S type thermocouple. The example is divided into five step-by-step procedures:

### 1) Configure Channel for K Type Thermocouple

Before calibration, configure the meter to accept a K type thermocouple input for CH1. Enter Code 2 and select [X11].

Note:

- For CH2 enter Code 4 and select [11X].
- For CH3 enter Code 5 and select [X21].
- For CH4 enter Code 6 and select [021].

### 2) Initial Calibration using K Type Thermocouple

Carry out an initial calibration of CH1 using the internal K type thermocouple reference:

- Connect a temperature simulator to the input module terminal pins.
- Short the input at the input module terminal pins (normally pins 1 and 2, or 1 and 3).
- Select [CAL] [121]. The meter toggles between [inPut] and [0.0V]. This is the meter's internal reference. Press the PROGRAM button.

At this point remove the short across the input module terminals.

- The meter toggles between [ZEro] and [32F]. Apply a 32 °F input and press the PROGRAM button.
- The meter toggles between [SPAN] and [2500F]. Apply a 2500 °F input and press the PROGRAM button.

### 3) Select Thermocouple Type

Enter Code 2 and select the S type thermocouple for CH1 [X13].

### 4) Decide on Temperature Measurement System Required

Unless otherwise requested, all Texmate meters configured for temperature applications are calibrated in degrees Fahrenheit (°F). If required, the meter display can be converted to degrees Celsius (°C) using the offset and scale factor settings in the manual calibration mode [CAL] [10X].

### 5) Calibrate Thermocouple using Two-point Calibration

Enter the calibration mode again and calibrate CH1 for an S type thermocouple using the two-point calibration mode [121].

## Configure Channel for K Type Thermocouple

**START HERE**

### Step 1

Enter brightness mode

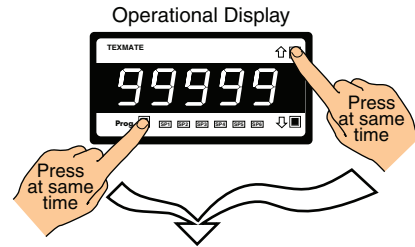

### Step 2

Pass brightness, calibration mode, Code 1, and enter Code 2

#### Example

Enter Code 2 for CH1. See list opposite for details on other channels

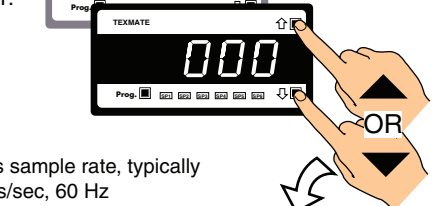
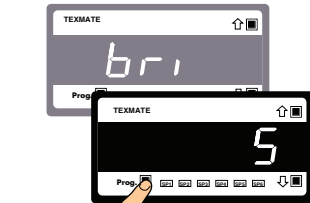

### Step 3

Set Code 2 to [011]:

- 1st Digit = 0 Selects sample rate, typically 10 samples/sec, 60 Hz
- 2nd Digit = 1 Selects thermocouple
- 3rd Digit = 1 Selects K type thermocouple



- |   |                             |
|---|-----------------------------|
| 0 | Type J                      |
| 1 | Type K                      |
| 2 | Type R                      |
| 3 | Type S                      |
| 4 | Type T                      |
| 5 | Type B                      |
| 6 | Type N                      |
| 7 | Select user defined Table 1 |

### Step 4



### Step 5

Exit Code 3. Return to operational display

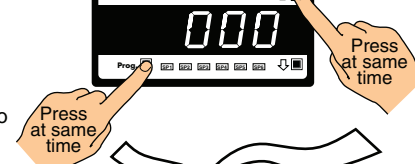

### Step 6

Enter the main programming mode.

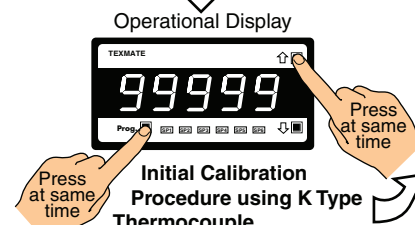

**Initial Calibration Procedure using K Type Thermocouple**

continued on next page (Step 7)

# Initial Calibration using K Type Thermocouple

From Step 6

**Short across input terminals.**  
Check installed input module pinout details for correct terminal connections

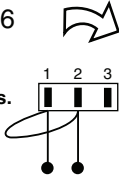

**Step 7**  
Pass brightness, and enter calibration mode



**Step 8**  
Set calibration mode to [121]:  
1st Digit = 1 Selects calibration procedures  
2nd Digit = 2 Selects calibrate thermocouple  
3rd Digit = 1 Selects CH1

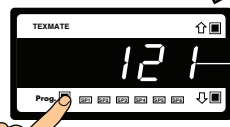

- 0 Result
- 1 CH1
- 2 CH2
- 3 CH3
- 4 CH4
- 5 -
- 6 -
- 7 -

**Step 9**  
Enter the 0.0 V internal reference menu



**0.0 V Reference Signal**

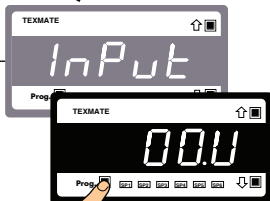

**Step 10**  
Remove short from terminals  
Save the 0.0 V reference setting and enter the ZERO input signal setting menu

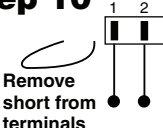

**32 °F Signal**

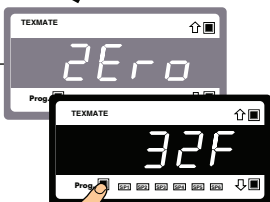

**Step 11**  
Save the ZERO input signal setting and enter the SPAN input signal setting menu



From Step 12

**2500 °F Signal**

Using the temperature simulator, apply a 2500 °F signal to the meter

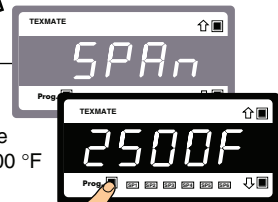

**Step 12**  
Save the SPAN input signal setting and return to the calibration mode

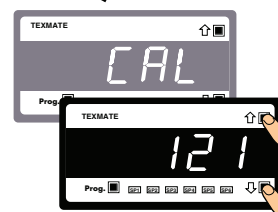

**Step 13**  
Reset the calibration mode to [000]

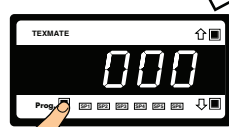

**Step 14**  
Exit the calibration mode

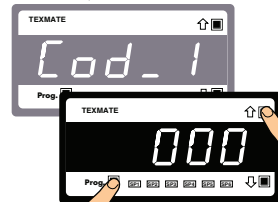

**Step 15**  
Exit Code 1. Return to operational display



Operational Display

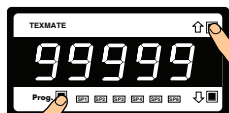

**Step 16**  
Enter the main programming mode

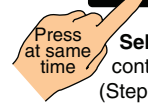

Select Thermocouple Type continued on next page (Step 17)

To Step 13

## Select Thermocouple Type

From Step 16

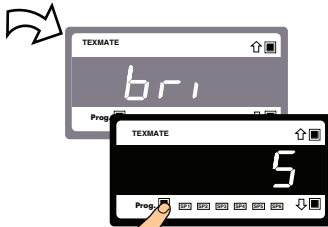

### Step 17

Pass brightness, calibration modes, Code 1, and enter Code 2



#### Example

Enter Code 2 for CH1



### Step 18

Set Code 2 to [013]:

- 1st Digit = 0 Selects sample rate, typically 10 samples/sec, 60 Hz
- 2nd Digit = 1 Selects thermocouple
- 3rd Digit = 3 Selects S type thermocouple



- 0 Type J
- 1 Type K
- 2 Type R
- 3 **Type S**
- 4 Type T
- 5 Type B
- 6 Type N
- 7 -

### Step 19



### Step 20

Exit Code 3. Return to operational display



Operational Display

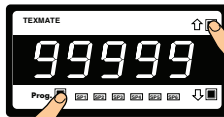

### Step 21

Enter the main programming mode

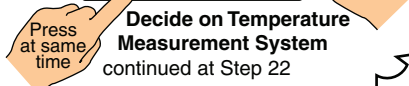

Decide on Temperature Measurement System  
continued at Step 22

## Converting °F to °C

continued from Step 21.

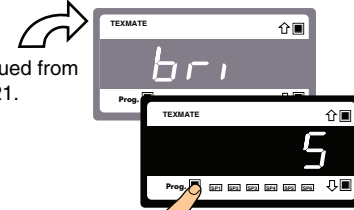

### Step 22

Pass brightness and enter the calibration mode



### Step 23

Set calibration mode to [111]:

- 1st Digit = 1 Selects calibration procedures
- 2nd Digit = 0 Selects manual calibration
- 3rd Digit = 1 Selects CH1

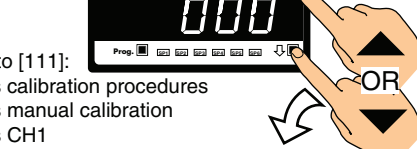

- | Result |
|--------|
| 1 CH1  |
| 2 CH2  |
| 3 CH3  |
| 4 CH4  |
| 5 -    |
| 6 -    |
| 7 -    |

### Step 24

Enter the offset menu



### Step 25

Set the offset to -178

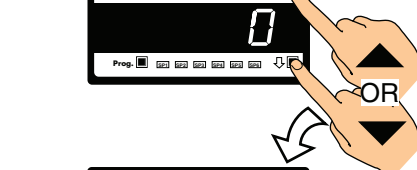

### Step 26

Save the offset setting. Enter the scale factor setting menu



### Step 27

Set the scale factor to [0.5555]

Note:  
For 6-digit meters set to [0.55555] and 8-digit meters set to [0.555555].

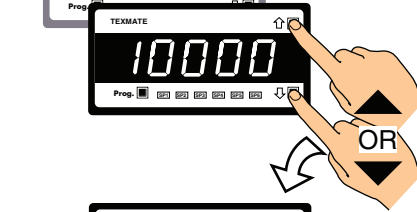

### Step 28

Save the scale factor setting. Enter the calibration mode.



Calibrate Thermocouple using Two-point Calibration  
continued at Step 29

# Calibrate Thermocouple using Two-point Calibration

continued from Step 28

## Step 29

Set calibration mode to [111]:  
 1st Digit = 1 Selects calibration procedures  
 2nd Digit = 1 Selects two-point calibration  
 3rd Digit = 1 Selects CH1

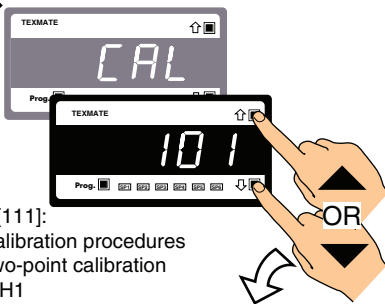

## Step 30

Enter the two-point calibration menu

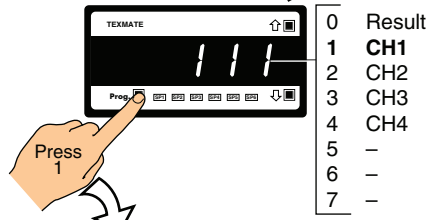

**LOW Signal**

Using the temperature simulator, apply a LOW input signal to the meter for S type thermocouple

## Step 31

Adjust the display to the desired LOW signal setting

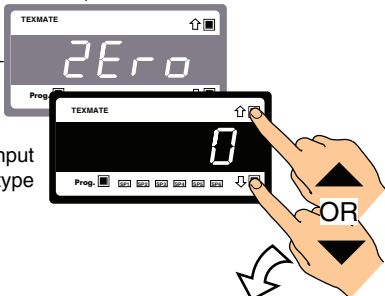

## Step 32

Save the LOW signal setting and enter the HIGH signal menu

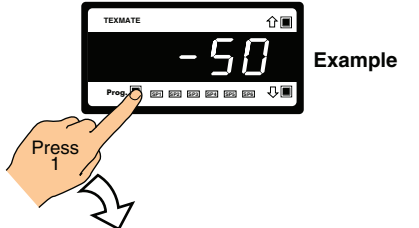

**HIGH Signal**

Using the temperature simulator, apply a HIGH input signal to the meter for S type thermocouple

## Step 33

Adjust the display to the desired HIGH signal setting

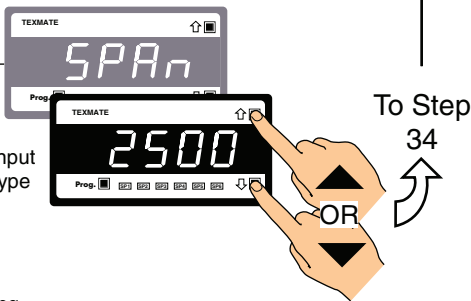

From Step 33

## Step 34

Save the HIGH signal setting

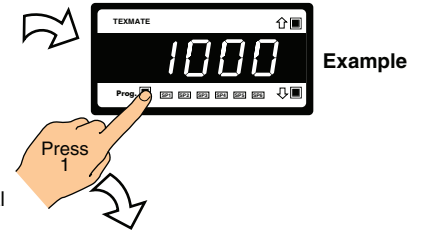

## Step 35

Reset the calibration mode to [000]

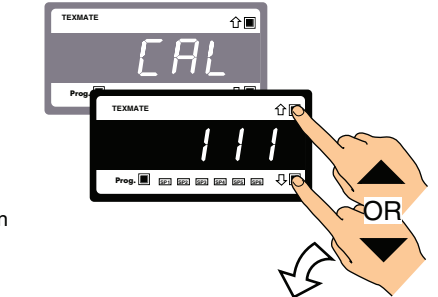

## Step 36

Exit the calibration mode

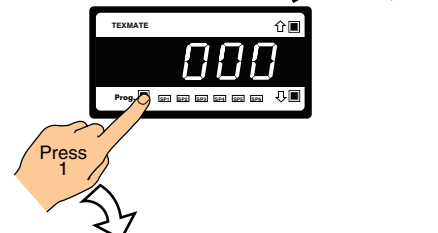

## Step 37

Exit Code 1. Return to operational display

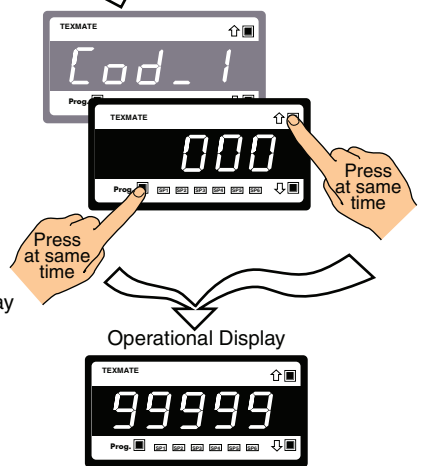



# RTD Calibration Procedures

## Example Procedure

The following example describes how to calibrate channel 1 (CH1) for a type 392 3-wire RTD. The example is divided into five step-by-step procedures:

### 1) Configure CH1 for Type 385 3-wire RTD

Before calibration, configure the meter to accept a type 385 3-wire RTD input for CH1. Enter Code 2 and select [X21].

Note:

- For CH2 enter Code 4 and select [21X].
- For CH3 enter Code 5 and select [X31].
- For CH4 enter Code 6 and select [X31].

### 2) Calibrate using Type 385 3-wire RTD

Calibrate CH1 for type 385 3-wire RTD:

- Connect a temperature simulator using a type 385 RTD connector to the input module terminal pins.
- Select [CAL] [131]. The meter toggles between [inPut] and [32.0F].
- Apply a 32 °F input and press the PROGRAM button.
- The meter toggles between [CAL] and [131]. Reset [CAL] to [000].

### 3) Select RTD Type

Enter Code 2 and select the type 392 3-wire RTD for CH1 [X13].

### 4) Decide on Temperature Measurement System Required

Unless otherwise requested, all Texmate meters configured for temperature applications are calibrated in degrees Fahrenheit (°F). If required, the meter display can be converted to degrees Celsius (°C) using the offset and scale factor settings in the manual calibration mode [CAL] [10X].

### 5) Calibrate RTD using Two-point Calibration

Enter the calibration mode again and calibrate CH1 for an type 392 3-wire RTD using the two-point calibration mode [121].

## Configure for Type 385 3-wire RTD

**START HERE**

### Step 1

Enter brightness mode

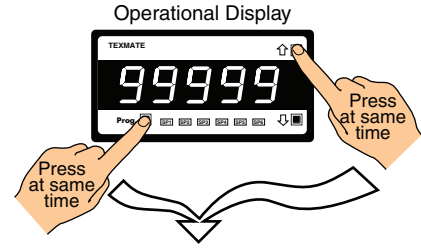

### Step 2

Pass brightness, calibration mode, Code 1, and enter Code 2

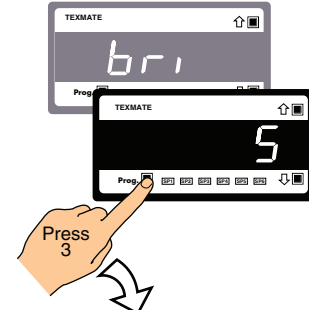

#### Example

Enter Code 2 for CH1. See note opposite for details on other channels

### Step 3

Set Code 2 to [021]:

- 1st Digit = 0 Selects sample rate, typically 10 samples/sec, 60 Hz
- 2nd Digit = 2 Selects RTD
- 3rd Digit = 1 Selects type 385 3-wire RTD

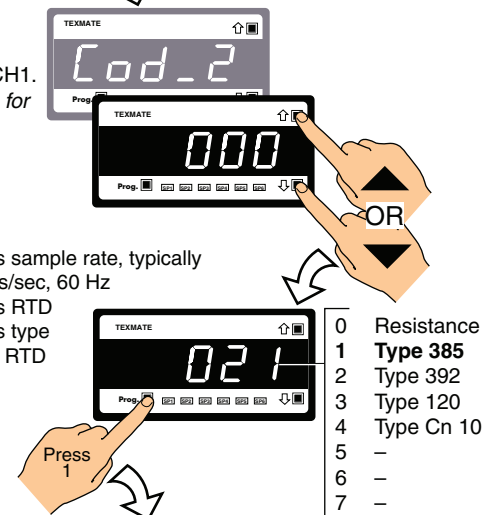

### Step 4

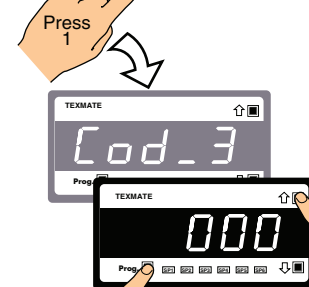

### Step 5

Exit Code 3. Return to operational display



### Step 6

Enter the main programming mode

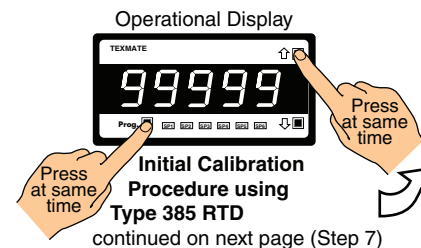



# Initial Calibration using Type 385 3-wire RTD

From Step 6

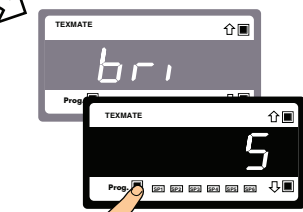

## Step 7

Pass brightness, and enter calibration mode



## Step 8

Set calibration mode to [131]:  
 1st Digit = 1 Selects calibration procedures  
 2nd Digit = 3 Selects calibrate RTD  
 3rd Digit = 1 Selects CH1

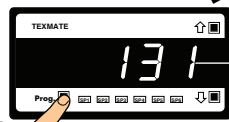

- 0 Result
- 1 CH1
- 2 CH2
- 3 CH3
- 4 CH4
- 5 -
- 6 -
- 7 -

## Step 9

Enter the 32 °F internal reference menu



**32 °F**  
Internal Reference

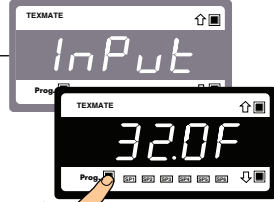

## Step 10

Pressing the PROGRAM button applies the 32 °F internal reference to the meter

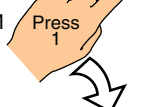

## Step 11

Reset the calibration Mmode to [000]

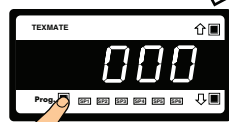

## Step 12

Exit the calibration mode



From Step 12

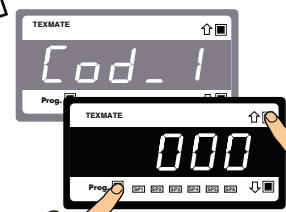

## Step 13

Exit Code 1. Return to operational display

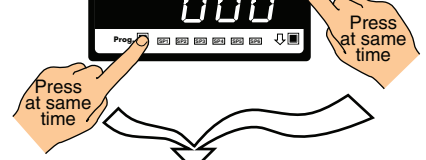

Operational Display

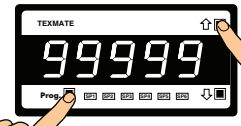

## Step 14

Enter the main programming mode

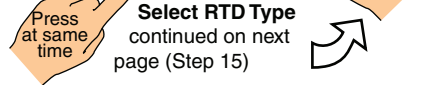

Select RTD Type continued on next page (Step 15)

To Step 13

## Select RTD Type

From Step 14

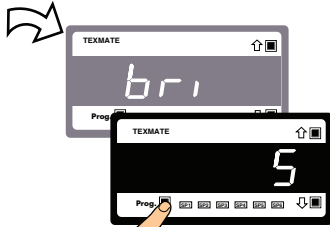

### Step 15

Pass brightness, calibration mode, Code 1, and enter Code 2



#### Example

Enter Code 2 for CH1

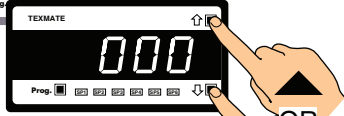

### Step 16

Set Code 2 to [022]:

- 1st Digit = 0 Selects sample rate, typically 10 samples/sec, 60 Hz
- 2nd Digit = 2 Selects 3-wire RTD
- 3rd Digit = 2 Selects type 392 RTD

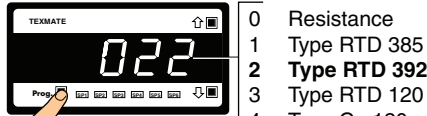

- 0 Resistance
- 1 Type RTD 385
- 2 **Type RTD 392**
- 3 Type RTD 120
- 4 Type Cn 120
- 5 -
- 6 -
- 7 -

### Step 17



### Step 18

Exit Code 3. Return to operational display

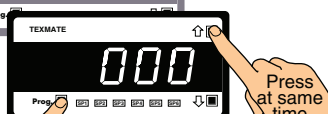

Operational Display

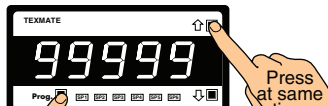

### Step 19

Enter the main programming mode

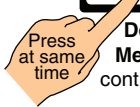

Decide on Temperature Measurement System  
continued at Step 20

## Converting °F to °C

continued from Step 19.

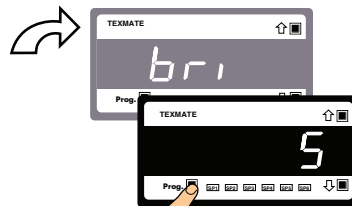

### Step 20

Pass brightness and enter the calibration mode



### Step 21

Set calibration mode to [101]:

- 1st Digit = 1 Selects calibration procedures
- 2nd Digit = 0 Selects manual calibration
- 3rd Digit = 1 Selects CH1

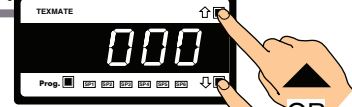

- 0 Result
- 1 CH1
- 2 CH2
- 3 CH3
- 4 CH4
- 5 -
- 6 -
- 7 -

### Step 22

Enter the offset menu



### Step 23

Set the offset to -178

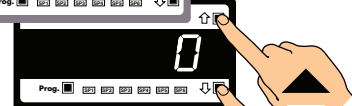

### Step 24

Save the offset setting. Enter the scale factor setting menu



### Step 25

Set the scale factor to [0.5555]

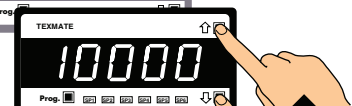

Note:

For 6-digit meters set to [0.5555]. For 8-digit meters set to [0.555555].

### Step 26

Save the scale factor setting. Enter the calibration mode.



Calibrate RTD using Two-point Calibration  
continued at Step 27

# Calibrate RTD using Two-point Calibration

continued from Step 26

## Step 27

Set calibration mode to [111]:  
 1st Digit = 1 Selects calibration procedures  
 2nd Digit = 1 Selects two-point calibration  
 3rd Digit = 1 Selects CH1

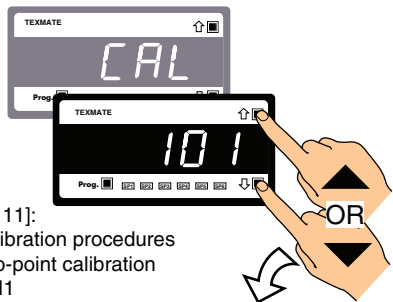

## Step 28

Enter the two-point calibration menu

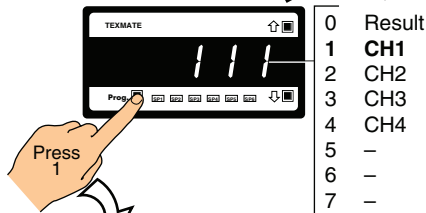

**LOW Signal**

Using the temperature simulator, apply a LOW input signal to the meter for type 392 RTD

## Step 29

Adjust the display to the desired LOW signal setting

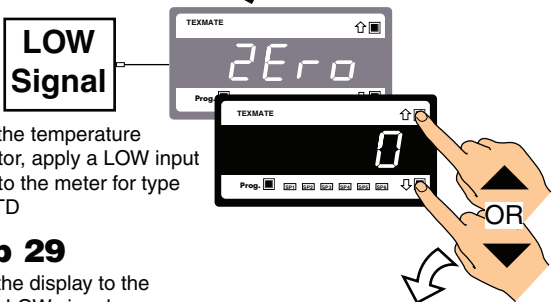

## Step 30

Save the LOW signal setting and enter the HIGH signal menu

**HIGH Signal**

Using the temperature simulator, apply a HIGH input signal to the meter for type 392 RTD

## Step 31

Adjust the display to the desired HIGH signal setting

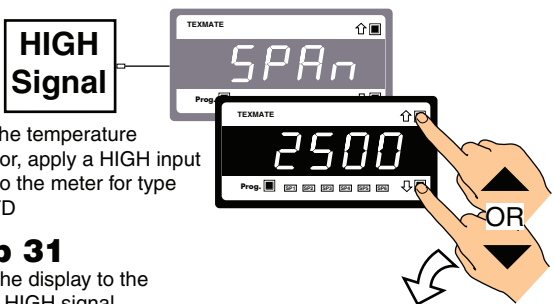

## Step 32

Save the HIGH signal setting

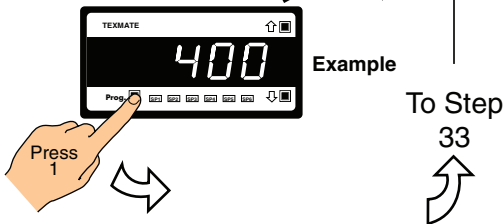

From Step 32

## Step 33

Reset the calibration mode to [000]

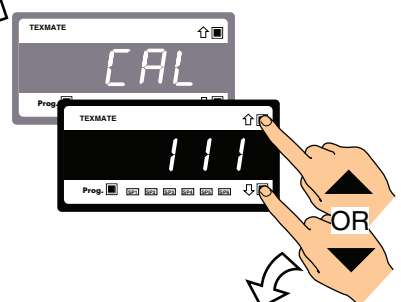

## Step 34

Exit the calibration mode

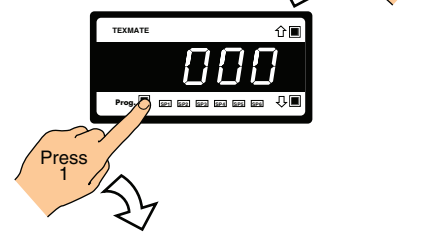

## Step 35

Exit Code 1. Return to operational display

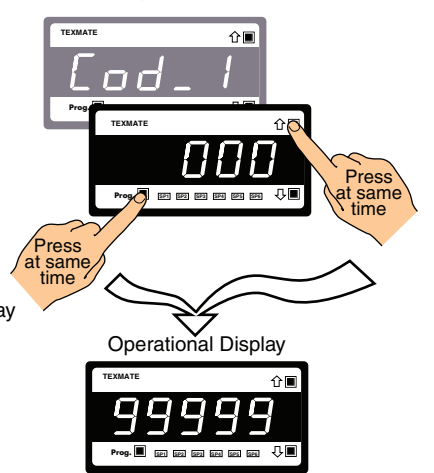

# Analog Output Calibration Procedures

## Calibration Setup Procedure

The calibration procedure is in two parts: scaling and calibration. The scaling settings can be changed independently of the calibration settings and vice versa. Before scaling and calibration:

- 1) Make sure the ANALOG OUTPUT SELECTION HEADER on the analog output module is set in the appropriate position: VOLTAGE or CURRENT.
- 2) Connect a multimeter to the analog output connector at the rear of the meter (pin 16 positive, pin 17 negative).

See Figure 14.

- 3) Make sure the multimeter is set to read the appropriate signal type: volts or milliamps.

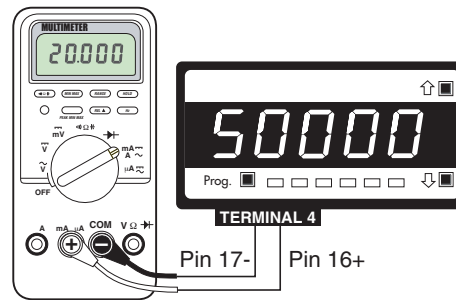

Figure 14 – Multimeter to Meter Connections

### Scaling

Scaling the analog output requires setting the zero [ZEro] and full scale [F\_SCL] parameters in [CAL] setting [251].

Zero is the setting at which the analog output is required to be at its calibrated **low** output. Full scale is the setting at which the analog output is required to be at its calibrated **high** output.

There are no limits to the difference between the zero and full scale settings. The difference can be anywhere between 1 count and the entire display range of the meter.

### Calibrating

Calibrating the analog output requires setting the [CAL\_L] and [CAL\_h] parameters in [CAL] setting [151]. [CAL] [151] internally calibrates the output in mA or volts independent of the meter input signal while in the calibration mode. [CAL\_L] is used to set the calibrated **low** output, and [CAL\_h] is used to set the calibrated **high** output. The calibrated low and high outputs can be set anywhere between -0.3 to 21 mA.

### Example

In our example procedure, we describe how to calibrate the analog output signal for 4 to 20 mA over the scaled range of 50 to 3000 counts. With a display of 50 counts, the analog output must be 4.000 mA. With a display of 3000 counts, the analog output must be 20 mA.

Steps 1 to 8 describe how to set the ZERO and FULL SCALE parameters. Steps 9 to 19 describe how to calibrate the meter's analog output mA/V low and high settings.

# Scale the Analog Output Span Range Settings

**START HERE**

**Step 1**  
Enter brightness mode

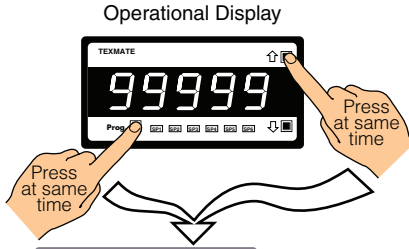

**Step 2**  
Pass brightness mode and enter calibration mode

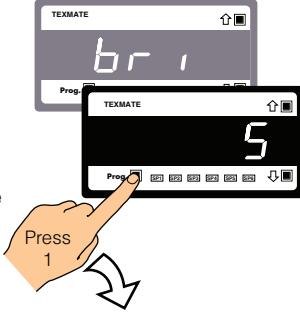

**Step 3**  
Set calibration mode to [251]:  
1st Digit = 2 Selects related calibration functions  
2nd Digit = 5 Selects scale analog output  
3rd Digit = 1 Select analog output 1 for scaling

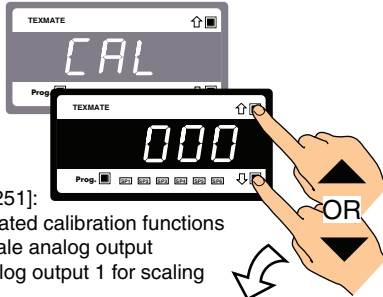

**Step 4**  
Enter [ZEro] setting mode

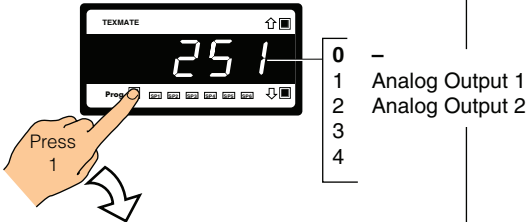

**Step 5**  
Adjust the display to 0.0 low analog output signal counts

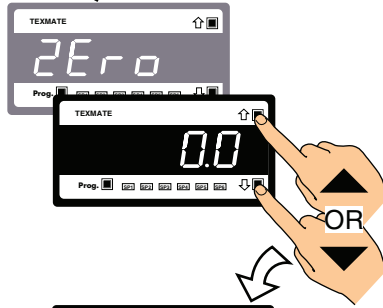

**Step 6**  
Save zero setting and enter full scale setting mode

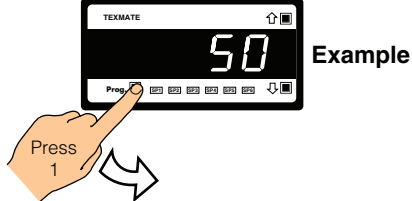

From Step 6

**Step 7**  
Adjust the display to 500.0 high analog output signal counts

*Note:*  
The scale settings may be changed at any time without having to recalibrate the analog mA/V output signal.

**Step 8**  
Save scale settings (zero and full scale). To return directly to the operational display, proceed to Step 17.

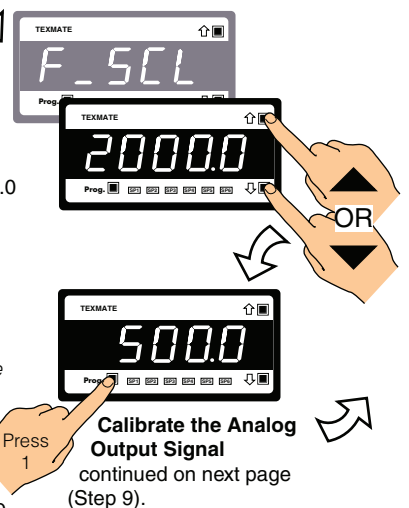

# Calibrate Analog Milliamp/Voltage Output Signal

continued from  
bottom of previous  
page

## Step 9

Set calibration mode to [15X]:  
1st Digit = 1 Selects calibration procedures  
2nd Digit = 5 Selects calibrate analog output  
3rd Digit = 1 Select analog output 1 for scaling  
as per Step 3

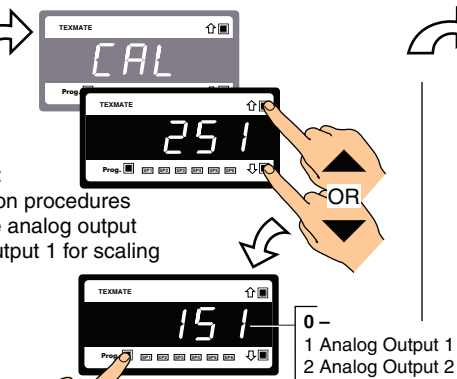

## Step 10

Enter analog output  
LOW signal  
calibration mode



## Step 11

Ensure the LOW analog  
output signal reading  
[CAL] on the multimeter  
display is 4.00 mA.

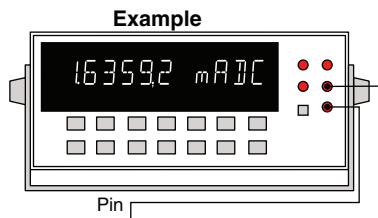

## Step 12

If not correct, press the  $\uparrow$  OR  $\downarrow$  button on the Tiger meter until the reading on the multimeter display is correct.

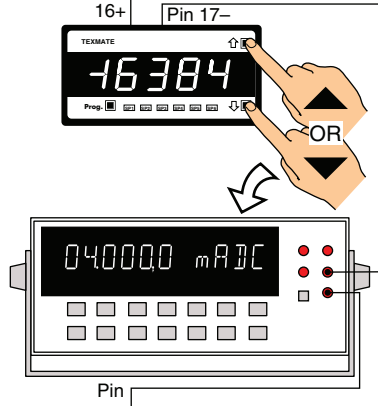

## Step 13

Save the LOW analog  
output signal setting. Enter  
analog output HIGH signal

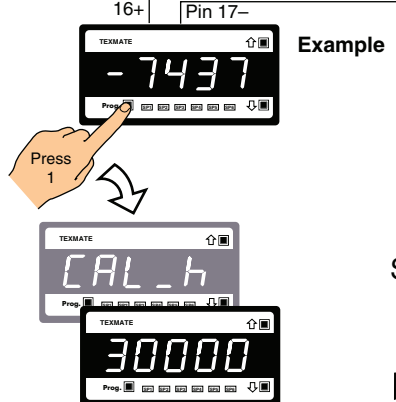

To  
Step  
14

## Step 14

Ensure the HIGH  
analog output signal  
reading [CAL\_h] on the  
multimeter display is  
20 mA.

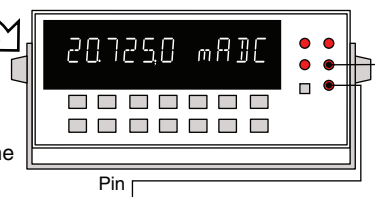

## Step 15

If not 20 mA, press the  $\uparrow$  OR  $\downarrow$  button on the Tiger meter until the reading on the multimeter display is correct.

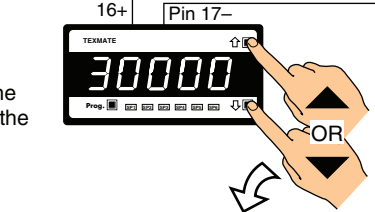

## Step 16

Return to the  
Calibration mode  
[CAL] menu

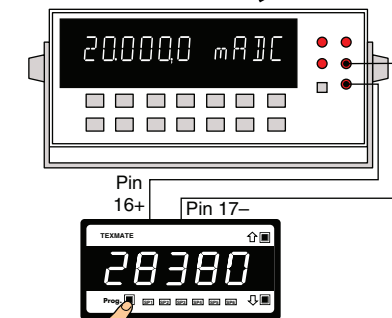

## Step 17

Reset calibration  
mode setting to [000]

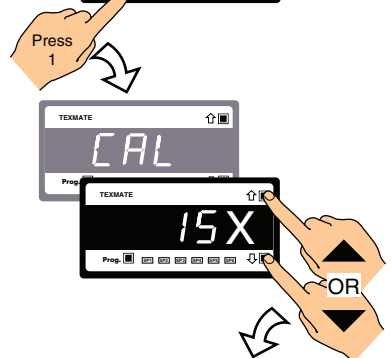

## Step 18

Save calibration  
mode [000] setting  
and enter Code 1

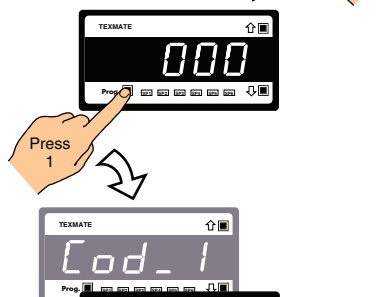

## Step 19

Exit Code 1 and  
return to operational  
display

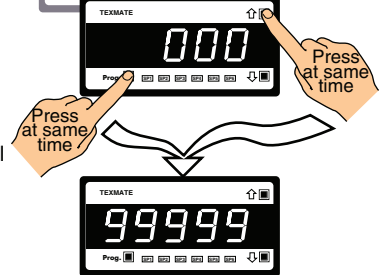

Operational Display

# Serial Communications Properties Procedure

## Example Procedure

Select the following baud rate, parity, time delay, and address settings for CH1:

- Baud Rate = 2400.
- Parity = OFF.
- Time Delay = 50 milliseconds.
- Address = 1.

**START HERE**

**Step 1**  
Enter brightness mode

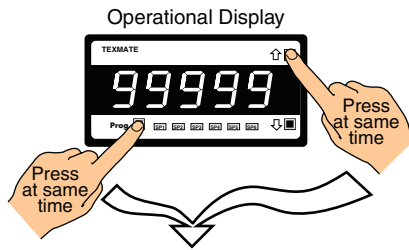

**Step 2**  
Pass brightness, enter calibration mode

**Example**  
Enter Code 2 for CH1.  
See list opposite for details on other channels

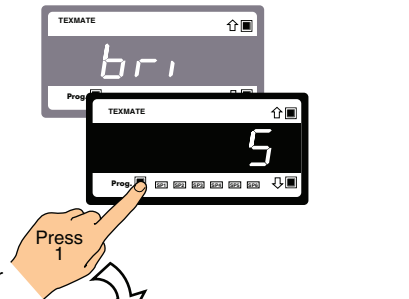

**Step 3**  
Set calibration mode to [201]:  
1st Digit = 2 Selects related calibration functions  
2nd Digit = 0 Selects Set serial communications properties  
3rd Digit = 1 Selects CH1

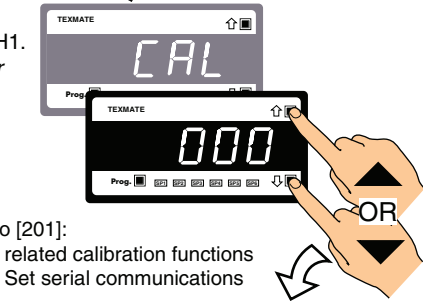

	Result
0	CH1
1	CH2
2	CH3
3	CH4
4	-
5	-
6	-
7	-

**Step 4**  
Enter the baud rate setting menu

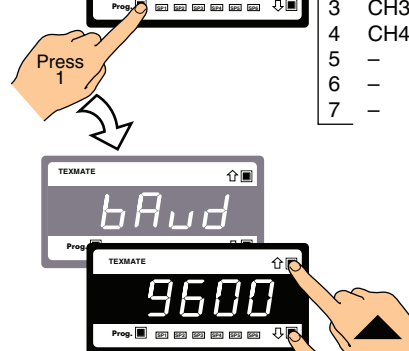

**Step 5**  
Set the baud rate to [2400]

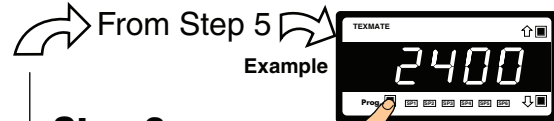

**Step 6**  
Save the baud rate. Enter the parity setting menu

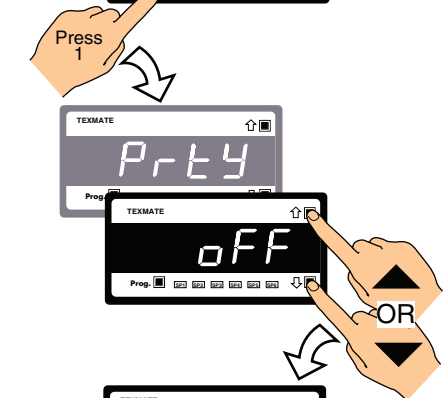

**Step 7**  
Set parity to [odd]

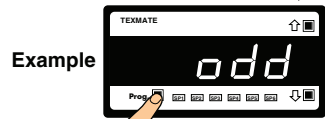

**Step 8**  
Save the parity setting

**Example**  
If Code 3 set to [001] continue thru Step 9, Time Delay setting. Otherwise continue to Step 11

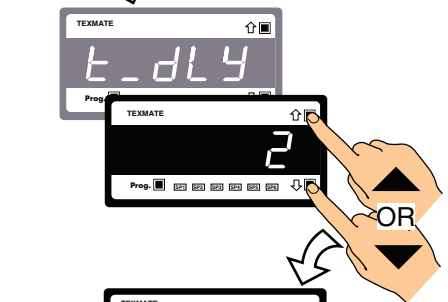

**Step 9**  
Set time delay to 50 msec

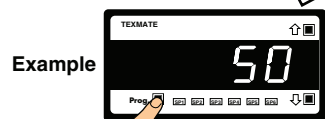

**Step 10**  
Save the time delay setting. Enter address setting menu



**Step 11**  
Set address to 1

To Step 6

**Step 12**  
Save the address setting. Return to the calibration mode [CAL]

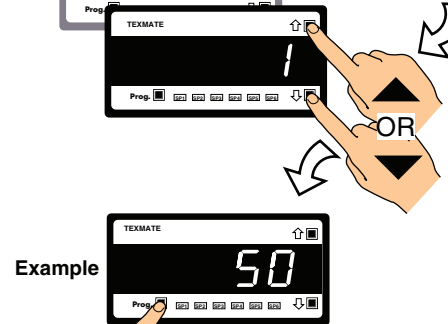

**Example**  
Serial Output Module Settings Procedure continued on next page (Step 13).

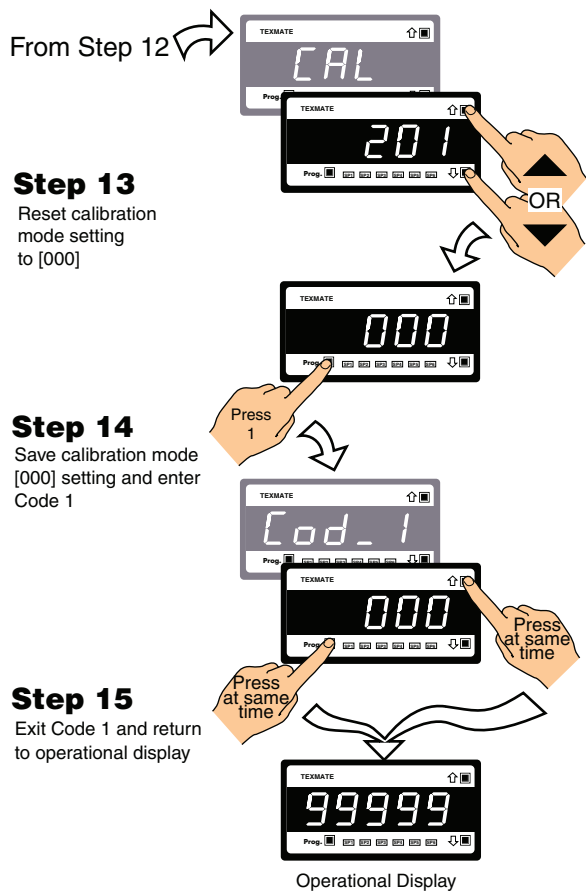

## Auto Zero Maintenance Procedure

### Example Procedure

Select the following auto zero maintenance settings for CH1:

- Auto Zero Capture Band = 20 counts.
- Auto Zero Motion = 5 counts/second.
- Auto Zero Aperture = 20 counts.

### Ranges

- Auto Zero Capture Band = 0 to 255.  
Default setting = OFF.
- Auto Zero Motion = 0 to 255.  
Default setting = 0.0.
- Auto Zero Aperture Window = 0 to 65535.  
Default setting = 0.0.



**START HERE**

**Step 1**  
Enter brightness mode

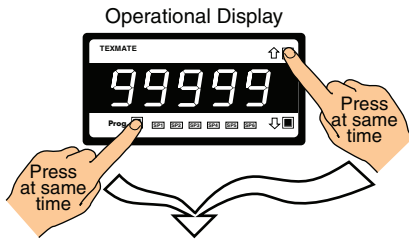

**Step 2**  
Pass brightness, enter calibration mode

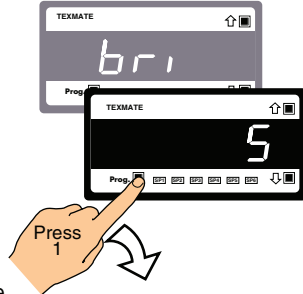

**Step 3**  
Set calibration mode to [211]:  
1st Digit = 2 Selects Related Calibration Functions  
2nd Digit = 1 Selects Auto Zero Maintenance  
3rd Digit = 1 Selects CH1

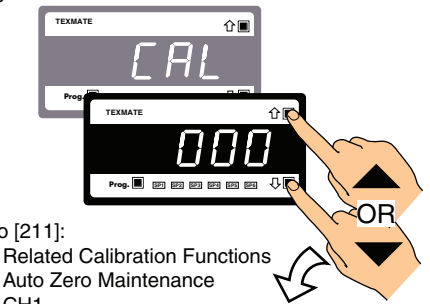

0	Result
1	CH1
2	CH2
3	CH3
4	CH4
5	-
6	-
7	-

**Step 4**  
Enter the auto zero capture band menu

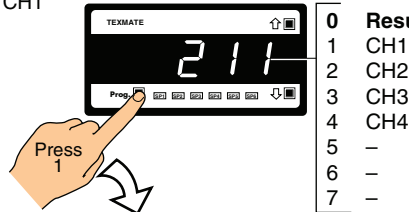

**Step 5**  
Set the auto zero capture band to 20 counts

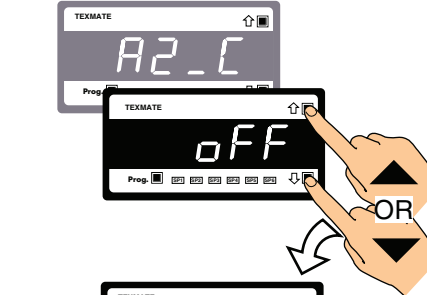

**Step 6**  
Save the auto zero capture band setting. Enter the auto zero motion menu

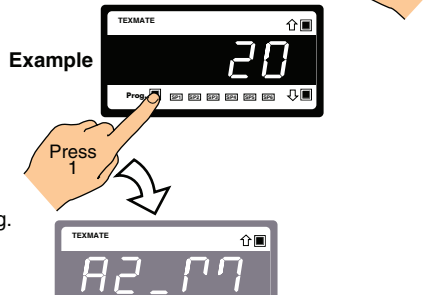

**Step 7**  
Set auto zero motion to 5 counts

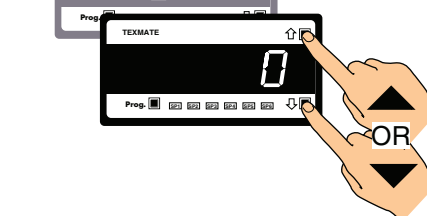

From Step 7

**Step 8**  
Save the auto zero motion setting. Enter the auto zero aperture window menu

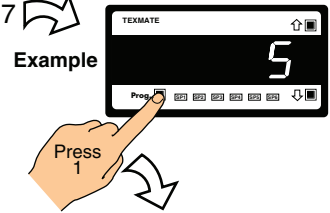

**Step 9**  
Set the auto zero aperture window to 20 counts

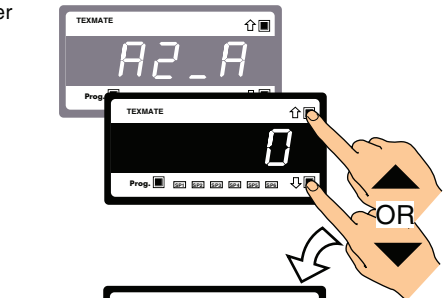

**Step 10**  
Save the the auto zero aperture window setting. Re-enter the calibration mode

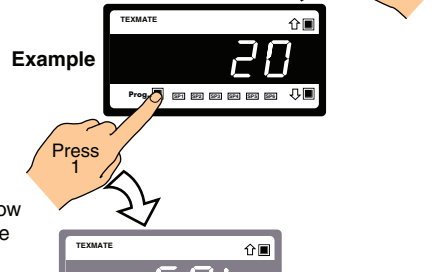

**Step 11**  
Reset [CAL] to [000]

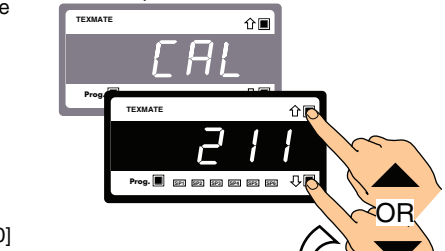

**Step 12**  
Save the auto zero maintenance settings

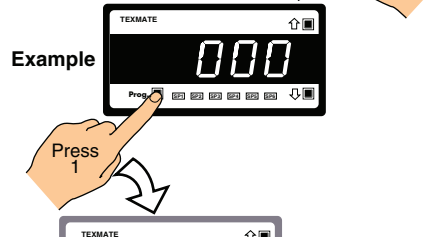

**Step 13**  
Exit Code 1 and return to operational display

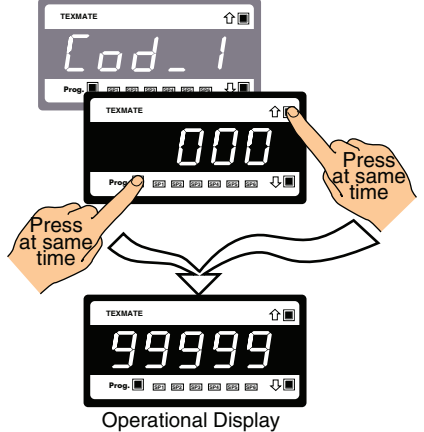

To Step 8

# Averaging Samples & Averaging Window Procedure

## Example Procedure

Select the following averaging sampling rate and averaging window settings for CH1:

- Averaging Sampling Rate = 10 samples.
- Averaging Window = 1000 counts.

## Ranges

- Averaging Samples = 0 to 255 samples.  
Default setting = OFF.
- Averaging Window = 0 to 65535 counts.  
Default setting = OFF.

**START HERE**

### Step 1

Enter brightness mode

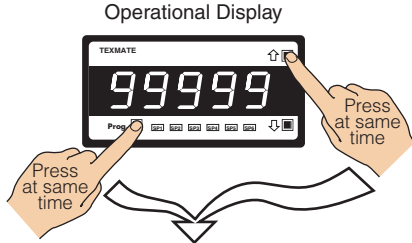

### Step 2

Pass brightness mode and enter calibration mode

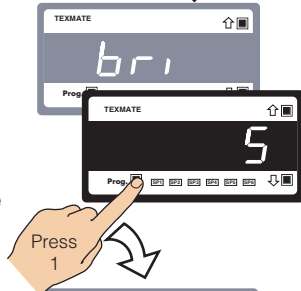

### Step 3

Set calibration mode to [221]:  
1st Digit = 2 Selects related calibration functions  
2nd Digit = 2 Selects averaging samples for 3rd digit  
3rd Digit = 1 Selects channel 1 for 2nd digit

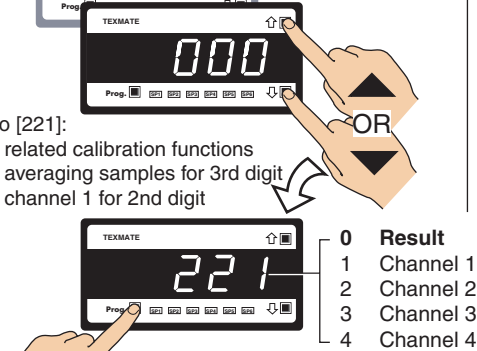

### Step 4

Save settings

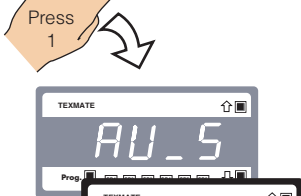

### Step 5

Select averaging sampling rate from 1 to 255 samples

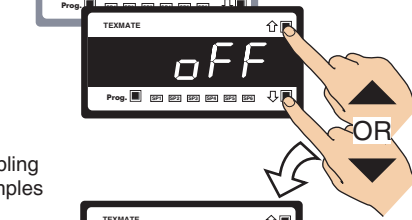

### Step 6

Save averaging sampling rate setting

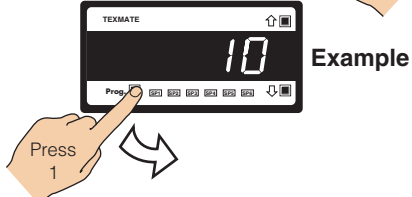

From Step 6

### Step 7

Select averaging window between 1 and 65535 counts

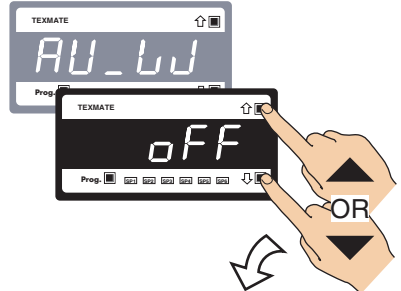

### Step 8

Save averaging window settings

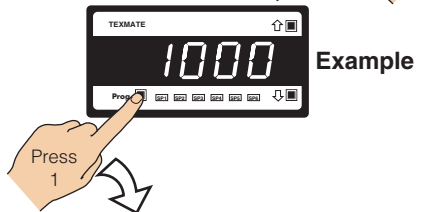

### Step 9

Select [000] to leave the calibration mode

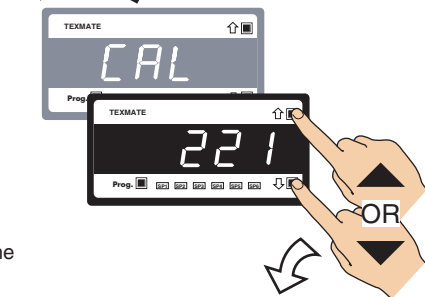

### Step 10

Save settings

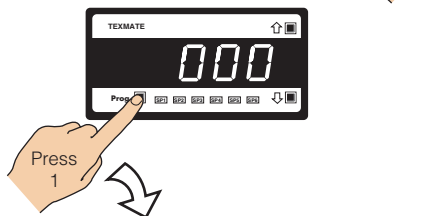

### Step 11

Exit Code 1 and return to operational display

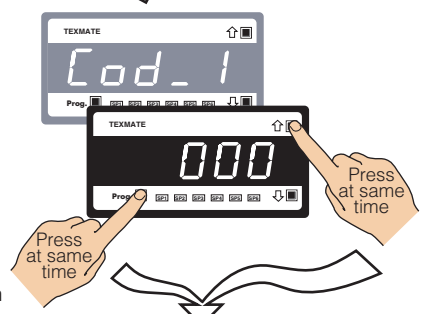

Operational Display

# Totalizer Settings Procedure

## Example Procedure

Our customer wishes to display and totalize a flow rate of 100 liters per minute with a resolution of 0.01 liters. They require the totalized flow rate to be displayed in units of 1 per 1,000 liters (1 per kiloliter) with a resolution of 0.01 of a kiloliter and reset to 0 after 1,000 kiloliters on the totalizer.

## Totalizer Settings

- Source of Totalizer 1 = **CH1**  
Default setting = OFF.
- Resolution of Totalizer 1 = **Hundredths**  
Default setting = No decimal point.
- Input Rate = **10000**  
Default setting = 10,000 counts.
- Running Time = **1 minute**  
Default setting = 1 hour.
- Total = **0.01 kiloliters**  
Default setting = 1.
- Cutoff = **0**  
Default setting = 1.
- Rollover = **On**  
Default setting = OFF.

**START HERE**

**Step 1**  
Enter brightness mode

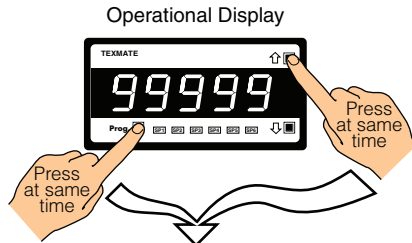

**Step 2**  
Pass brightness mode and enter calibration mode

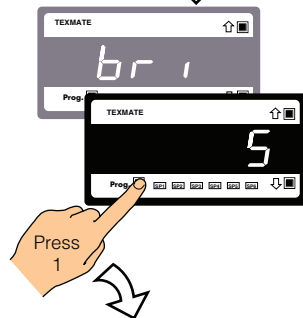

**Step 3**  
Set calibration mode to [231]:  
1st Digit = 2 Selects related calibration functions  
2nd Digit = 3 Selects totalizer settings mode  
3rd Digit = 1 Selects CH1 for calibration

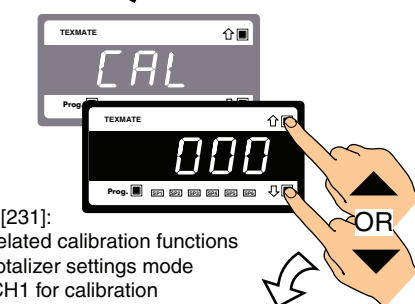

**Step 4**  
Enter the input rate setting mode.

The default setting is 10,000 counts. If your setting is not 10,000 then reset to your required setting

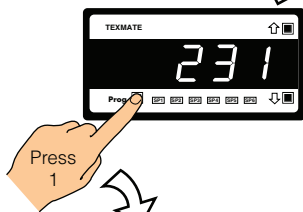

**Step 5**  
Save the input rate setting

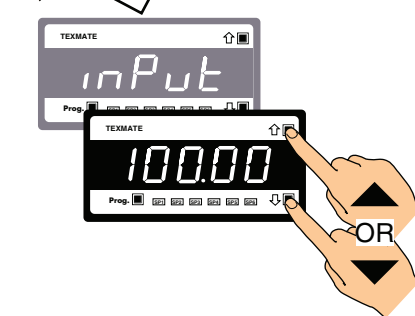

From Step 5

**Step 6**  
Enter the running time mode

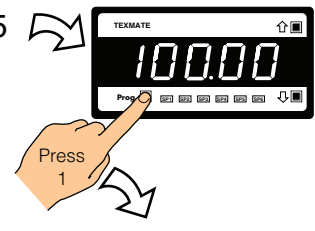

**Step 7**  
Set the running time to 1 minute

**Note:**  
The default running time is 1 hour

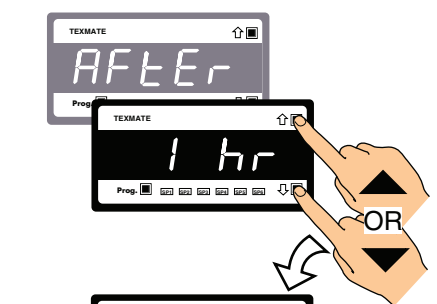

**Step 8**  
Enter the required total mode

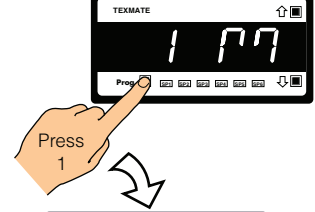

**Step 9**  
Set the total to 0.01  
Note, the default total is 1. But, depending on the resolution setting, as in our example the 1 may have a decimal point and a zero before it

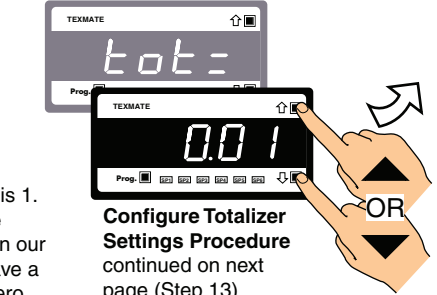

**Configure Totalizer Settings Procedure** continued on next page (Step 13)

**Configure Totalizer Settings Procedure**  
continued from bottom of previous page

**Step 10**

Enter the **cutoff** mode

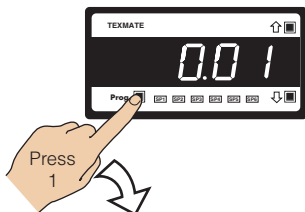

**Step 11**

Set cutoff to 0

**Note, cutoff can be set anywhere between -19999 to 32767 counts**

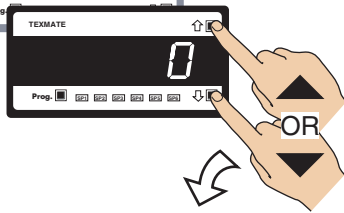

**Step 12**

Enter the **rollover** mode

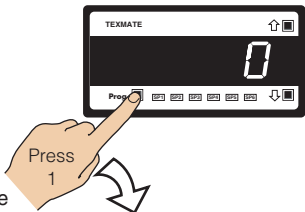

**Step 13**

Set the **rollover** mode to OFF

**Note, the rollover default setting is OFF**

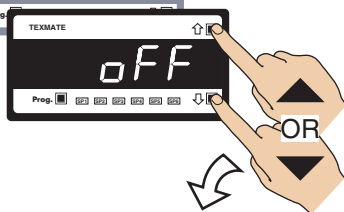

**Step 14**

Reset calibration mode to [000]

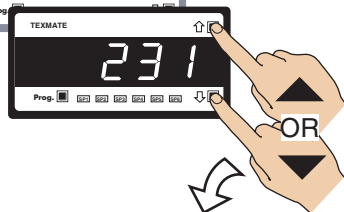

**Step 15**

Exit the calibration mode and enter Code 1

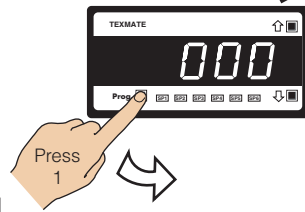

From Step 15

**Step 16**

Exit Code 1 and return to the operational display

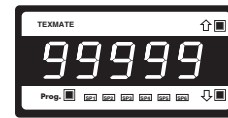
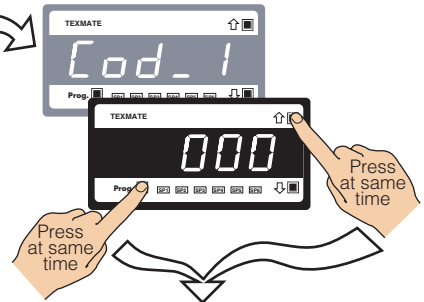

Operational Display

To Step 16

# 32-point Linearization Table Setup Procedures

## Application Examples

### Linearizing Sensor Output using the Manual Setup Mode

For the greatest accuracy when linearizing a sensor output, calculate the output curve of the level sensor and then place up to 32 points along the curve.

For example, Figure 15 shows the dimensions and total capacity of the tank. These can be used to calculate the sensor output curve. The level sensor output curve can then be drawn using the calculated points. From the output curve we can decide where to place the 32 flexible points to reduce the error on the most non-linear sections of the curve. The points (seven in this case) are then manually entered into the linearization table in the meter.

### Linearizing Sensor Output using the Auto Setup Mode

The auto setup mode is used when the linearization curve from a sensor output is not known, but the sensor output can be used to load the reference data into the 32 points of the linearization table.

The auto setup mode allows a sensor input to be directly applied to a linearization table in the meter over 32 points. The corresponding display reading for each selected point is then entered into the table.

This method is usually less accurate than the manual setup mode as the 32 points are normally programmed into the meter in equal divisions and do not concentrate on the most non-linear areas.

In the diagram below, using the auto setup mode the following equipment and criteria are used to plot the level of the tank over 32 increments of the tank's total volume:

- Output from the level sensor connected to the meter.
- Total volume of the tank (830 ℓ).
- Meter calibrated to the level sensor output when the tank is empty and full.
- Metering device to measure liquid.

The linearization table has up to 32 flexible points available for storing the linearization data. The fuel tank is emptied and then filled in 32 steps (if 32 points is required) using a metering pump or similar measuring device. At each step the volume of the tank is entered and stored

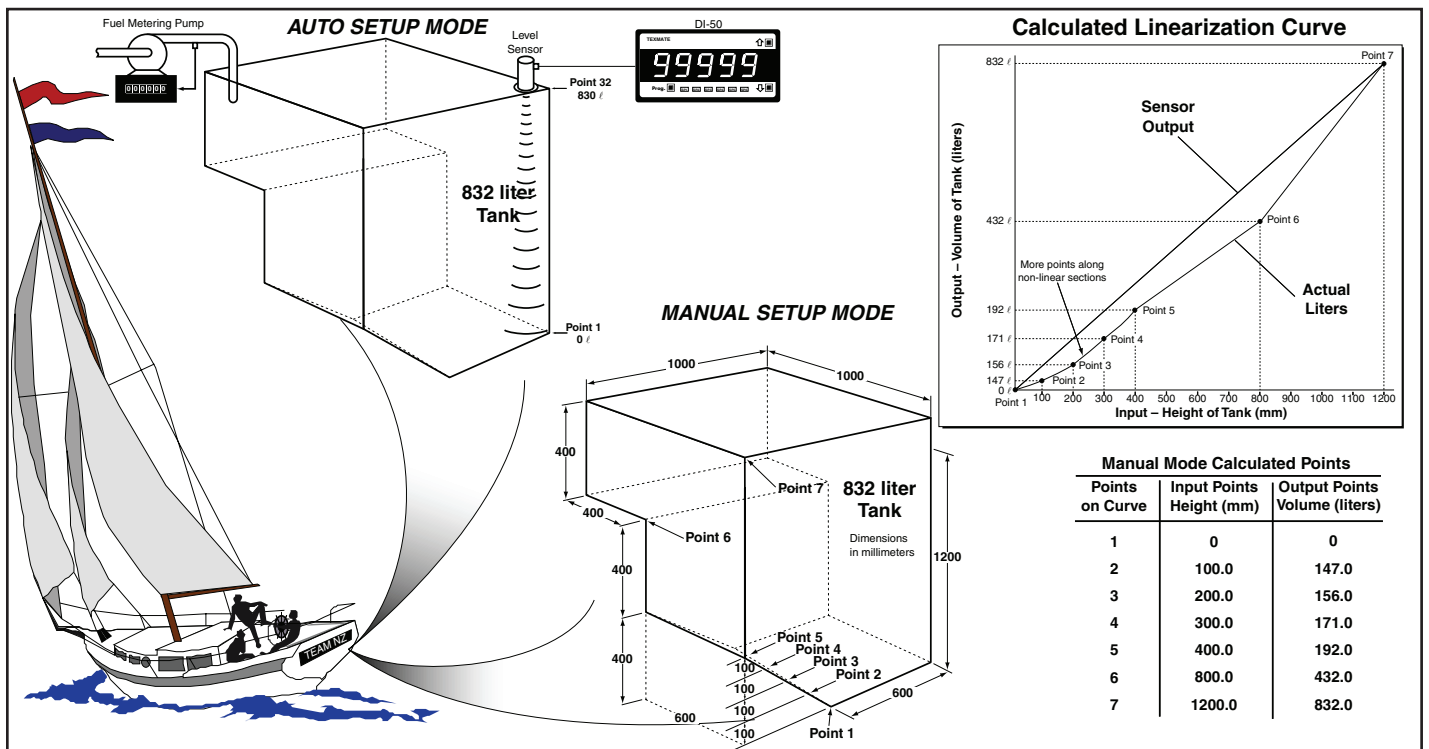

Figure 15 – Example of Manual and Auto Linearization Data

# Manual Mode Application Example

The following example application procedures uses the known linearization data shown in Table 1 below to set up the linearization table using the **manual setup mode**.

Our customer has a yacht with an irregularly shaped fuel tank complete with mA or voltage output level sensor. The customer requires to linearize the output from the level sensor to provide greater accuracy when displaying the amount of fuel in the tank.

Texmate installed a Tiger DI-50 meter and connected it to the level sensor. The meter is calibrated using the level sensor to provide an input related to the height of the tank.

Points on Curve	Input Points (Height in mm)	Output Points (Volume in liters)
1	0	0
2	100.0	35.7
3	200.0	76.4
4	300.0	122.2
5	400.0	173.1
6	800.0	436.0
7	1200.0	832.0

This provides the meter span range for the linearization data points, which results in the level sensor input displaying the volume of the tank in liters when a linearization table is loaded.

For details on the auto setup mode, see *Linearizing Supplement (NZ207)*.

## START HERE

**Note:** Ensure the decimal point is set to the correct position in Code 1.

**Step 1**  
Enter brightness mode

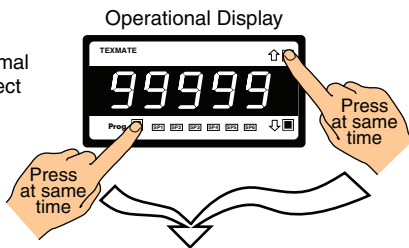

**Step 2**  
Pass brightness, enter calibration mode

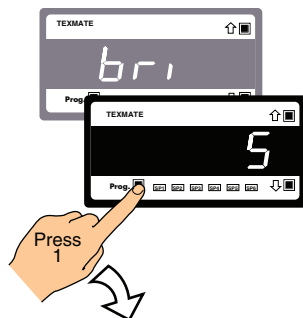

**Step 3**  
Set calibration mode to [241]:  
1st Digit = 2 Selects Related Calibration Functions  
2nd Digit = 4 Selects Setup 32-point Linearization Tables  
3rd Digit = 1 Selects CH1

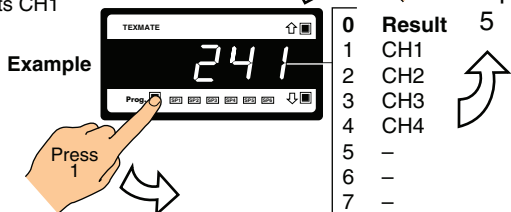

**Step 4**  
Enter the setup 32-point linearization tables menu

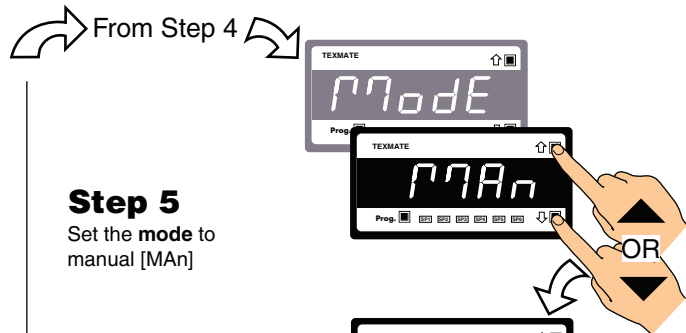

**Step 5**  
Set the mode to manual [MAN]

**Step 6**  
Save the manual mode setting. Enter the table number setting menu

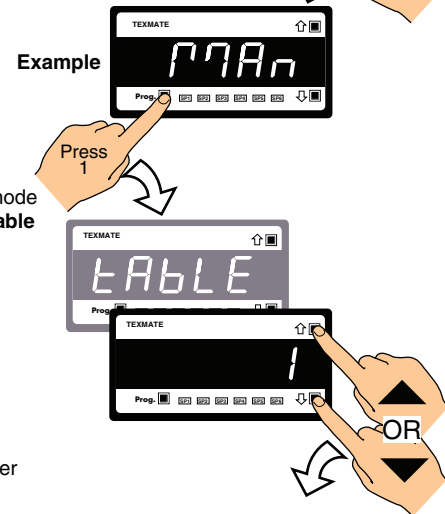

**Step 7**  
Set the table number

**Step 8**  
Save the table number setting. Enter the date setting menu

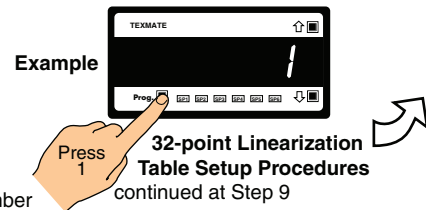

continued from Step 8

### Step 9

Set the date using the week and year

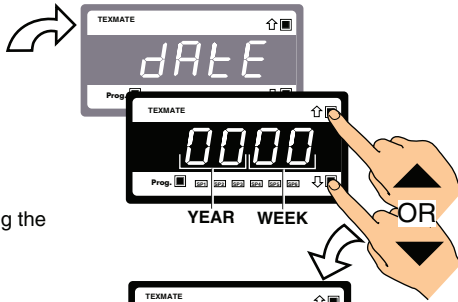

Example

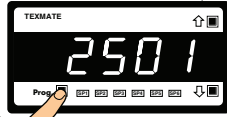

### Step 10

Save the date setting. Enter the serial number setting menu



Example

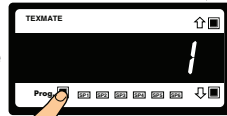

### Step 11

Set the serial number. Enter the first input point

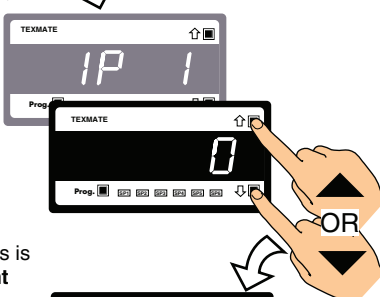

### Step 12

Save the serial number. Enter the first input point

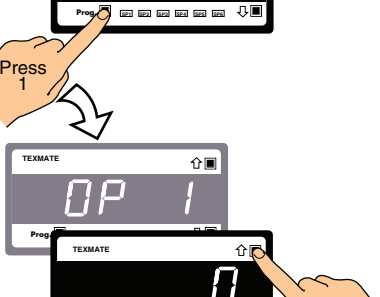

### Step 13

Set input point 1 to 0 (this is the first point in the Height column of Table 1)

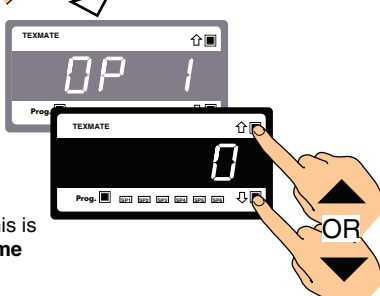

### Step 14

Save input point 1. Enter output point 1 setting menu

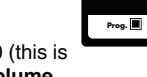

### Step 15

Set output point 1 to 0 (this is the first point in the Volume column of Table 1)

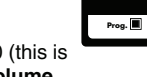

From Step 15

### Step 16

Save output point 1. Enter input point 2 setting menu.

Example

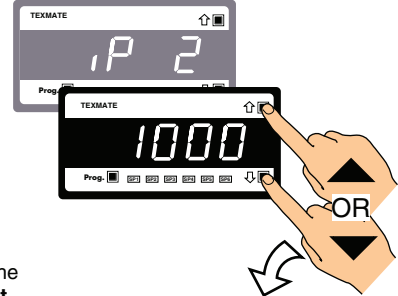

### Step 17

Set input point 2 to 9200 (An extra 0 needs to be added to ensure decimal point placement in output point 2 is correct (This is the second point in the Output column of Table 2). The decimal point is placed before the last digit in Code 1

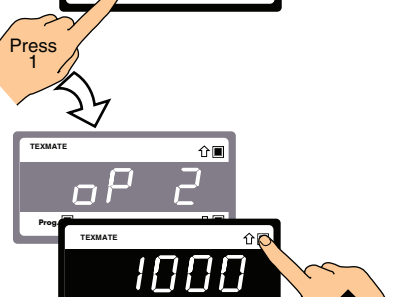

### Step 18

Save input point 2. Enter output point 2 setting menu

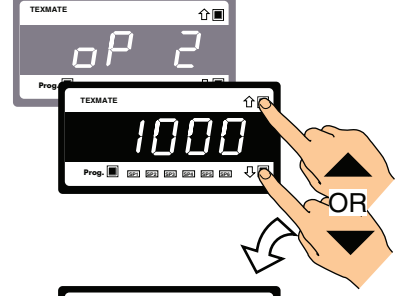
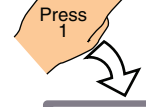

### Step 19

Set output point 2 to 357

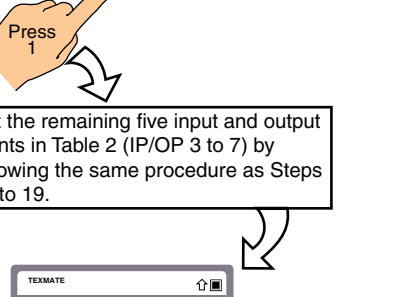

### Step 20

Save output point 2. Enter input point 3 setting menu

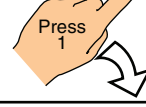

### Step 21

Set the remaining five input and output points in Table 2 (IP/OP 3 to 7) by following the same procedure as Steps 16 to 19.

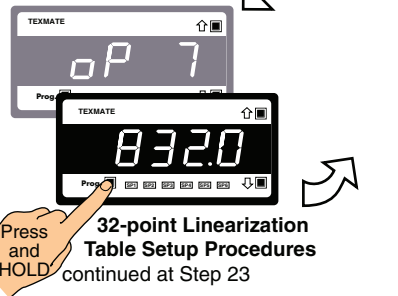

### Step 22

After setting output point 7, press and HOLD the Prog. button until the meter displays [End ?] then [CAL] [241]

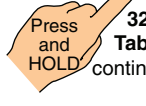

32-point Linearization Table Setup Procedures continued at Step 23

**32-POINT LIN SETUP 2**

continued from Step 22

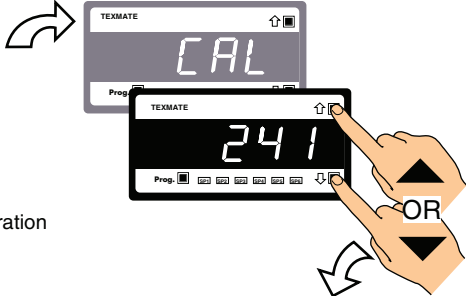

**Step 23**

Reset the calibration mode to [000]

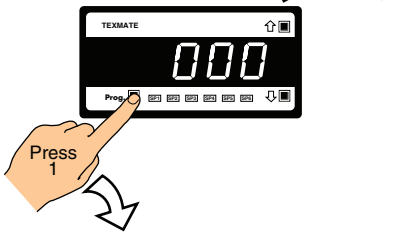

**Step 24**

Exit the calibration mode

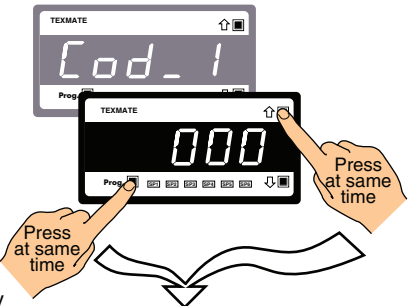

**Step 25**

Exit Code 1. Return to operational display

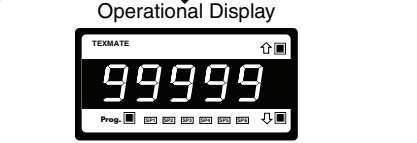

1934 Kellogg Ave., Carlsbad, CA 92008



Tel: (760) 598-9899



Fax: (760) 598-9828



URL: <http://www.texmate.com>

For ordering info call: . . . 1-800-TEXMATE (1-800-839-6283)

For tech assistance call: . . . . .(760) 598-9899

Local Distributor Address.....