



SM-35X

Multirange Panel Meter
3.5 Digit 0.48" LCD
In a Slim Bezel Case

An Economical, Multirange 2V, 20V & 200V DC Easily-Scaled 5V DC Powered Meter with a .48" LCD Display and Screw terminal or Edge Connector Inputs.

General Features

The SM-35X is one of Texmate's new SM-series meter range. This range, which includes meters with LCD and LED displays, offers many unique features designed to simplify installation, calibration and scaling. All SM-35 and SM-35X meters are pin-compatible, which enables LED and LCD meters to be interchanged within the same panel without necessitating wiring or panel cutout changes.

All SM-series meters are 5 V DC powered with bipolar single-ended inputs. The meters feature Display Hold, Display Test and Auto-Polarity indication. The polarity indication may be disabled or reversed by repositioning jumper clips on internal header pins. The SM-series of meters are designed to be user scalable to almost any engineering unit of readout. On-site scaling and recalibration is facilitated by multi-turn potentiometers that provide continuous fine and coarse adjustment within each of the three header-programmable full scale ranges.

The three ranges provided with the SM-35X (LCD display) and the SM-35 (LED display) are 2 V, 20 V, and 200 V full scale and both of these meters can be ordered with an optional zero-off-set adjustment potentiometer.

The SM-35XMV (LCD display) and SM-35MV (LED display) are specially designed for low voltage inputs and provide three header-programmable input ranges of 20 mV, 200 mV, and 200 V full scale. Both the SM-35XMV and SM-35MV have zero-off-set adjustment potentiometers as a standard feature and a unique constant current power supply that eliminates any ground loop noise.

Typical Application Connections

DC VOLTMETER

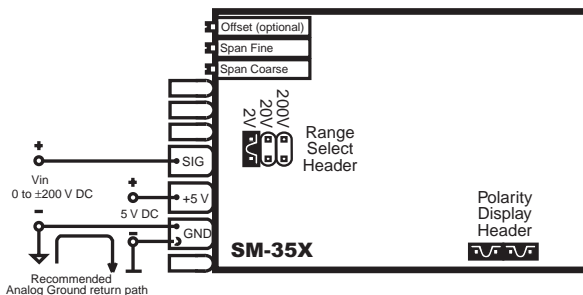

Compatibility

The SM-Series is shipped in a standard Slim Bezel case. The Slim Bezel case is compatible with the CM, SP, PM, & TM Series of meters. The SM-Series can be ordered in End Mount cases for twin mounting or combinations of multiple center mount cases and two end mount cases for stack mounting.

SLIM



BEZEL

Specifications

- Input Configuration:**Single-ended, with optional provision to offset the zero of the reading displayed
- Input Impedance:**1MΩ minimum
- Full Scale Ranges:**±2 V DC (Standard Range) ±20 V DC ±200 V DC (All ranges are header selectable)
- A/D Converter:**12 Bit Dual Slope
- Accuracy:**±(0.05% of reading + 2 digits)
- Temp Coefficient:**100ppm/°C typical
- Warmup Time:**One minute to specified accuracy
- Conversion Rate:**3 readings per second
- Display:**0.48" Liquid Crystal Display (LCD); "Display Hold" & Dummy Zero
- Decimal Selection:**User programmable to 3 positions
- Polarity:**Automatically displays both "+" or "-" signs; header programmable polarity disable and reversal
- Over-range Indication:**When input exceeds full scale on any range being used, the most significant "1" digit and "+" or "-" symbol is displayed with all other active digits blanked
- Power Supply:**+4.5 to +5.5V DC at 5mA
- Operating Temperature:** ...-20°C to +60°C
- Storage Temperature:**-20°C to +70°C
- Relative Humidity:**95% (non-condensing)
- Case Dimensions:**Bezel (2.755"W x 1.170"H) 69.68mmW x 29.72mmH Depth behind bezel (3.315") 84.2mm Plus (0.685") 17.4mm for connector
- Weight:**88 gms (3.1 oz) 143 gms (5 oz) when packed

SM-Series LED Displays

- SM-353.5 digit Red LED, 2/20/200VDC, 5VDC Pwr
- SM-35MV3.5 digit Red LED, 0.02/0.2/2VDC, 5VDC Pwr

SM-Series LCD Displays

- SM-35X3.5 digit LCD, 2/20/200VDC, 5VDC Pwr
- SM-35XMV3.5 digit LCD, 0.02/0.2/2VDC, 5VDC Pwr

Functional Diagram

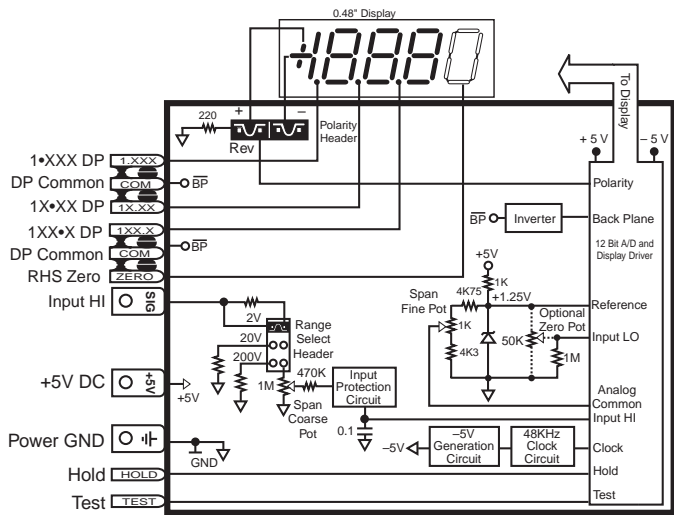

Connector Pinouts

For most applications where it is not necessary to activate Display Hold, Display Test, or remotely change the selected decimal point and dummy zero, the three screw terminal blocks supplied with the meter can be used to connect Signal Low Input and Power Supply Ground (joined on the one terminal), Signal High Input and +5 V DC Power Input. For other applications, the Texmate SM-35X interconnects by means of a standard PC board edge connector having two rows of 10 pins each, spaced on 0.156" centers. Connectors are available from Texmate, or from almost any connector manufacturer.

CAUTION: This meter employs high impedance CMOS inputs. Although internal protection has been provided for several hundred volt overloads, the meter will be destroyed if subjected to the high kilovolts of static discharge that can be produced in low humidity environments. Always handle the meter with ground protection.

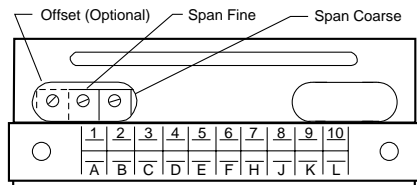

REAR OF METER WITH PCB EDGE CONNECTOR MOUNTED
(For mounting of screw terminal blocks see below)

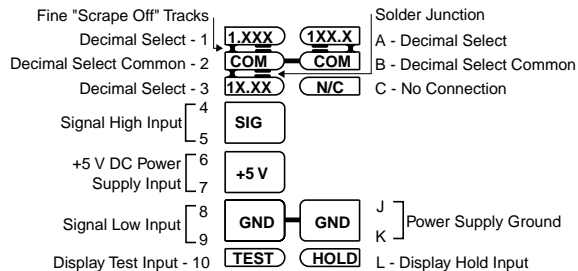

Pin A,C, 1 and 3 - Decimal Select and Dummy Zero: Decimal points and dummy zero may be blanked as required by carefully scraping off the fine tracks linking these pins to Decimal Select Common using a pair of pliers or a small screwdriver blade. Re-connect either by linking the appropriate pins on the connector or by solder-bridging the junctions located on the PC board edge fingers. **CAUTION:** Do not connect either the dummy zero or the decimal select to power supply ground. Although the dummy zero and decimals will become activated when their select pins are grounded, this improper connection will eventually cause permanent damage to the display.

Pins B and 2 - Decimal Select Common: Common return pins for decimal point selection (see CAUTION above.)

Pins J and K - Power Supply Ground: Power supply ground return (Note: Separate connections to Pins J and K and Pins 8

and 9 are recommended when using edge connectors with the meter to minimize ground loop effects.)

Pin L - Display Hold Input (CMOS compatible): If Pin L is left open, the meter will operate in a free-running mode. While Pin L is connected to +5 V DC Power Supply Input Pins 6 and 7, the meter will latch up; A/D conversions will continue but the display will not be updated until Pin L is released.

Pins 4 and 5 - Signal High Input: Signal inputs for all voltage ranges are applied to these pins. Maximum overvoltage protection is ± 400 V DC or 280 V AC. See CAUTION:ELECTRIC SHOCK HAZARD on rear page.

Pins 6 and 7 - +5 V DC System Power Input: The meter requires a regulated low-ripple 5 V DC power supply applied to these pins.

Pins 8 and 9 - Signal Low Input: Signal low input of the analog to digital converter circuits (Note: When measuring input signals (on the 2 V range) that are not isolated from the +5 V DC supply used to power the meter, a ground loop can be created that will cause the least significant digit to exhibit errors and instability. To avoid this problem the ground return path of the analog signal should be connected to the power supply ground only at the Signal Low Input Pins 8 and 9 of the meter.)

Pin 10 - Display Test Input: All numeric display segments will operate when Pin 10 is connected to +5 V DC Power Supply Input Pins 6 and 7. **CAUTION:** The Display Test function is only intended for momentary operation. Continuous application of Display Test will, in time, damage the display.

Component Layout

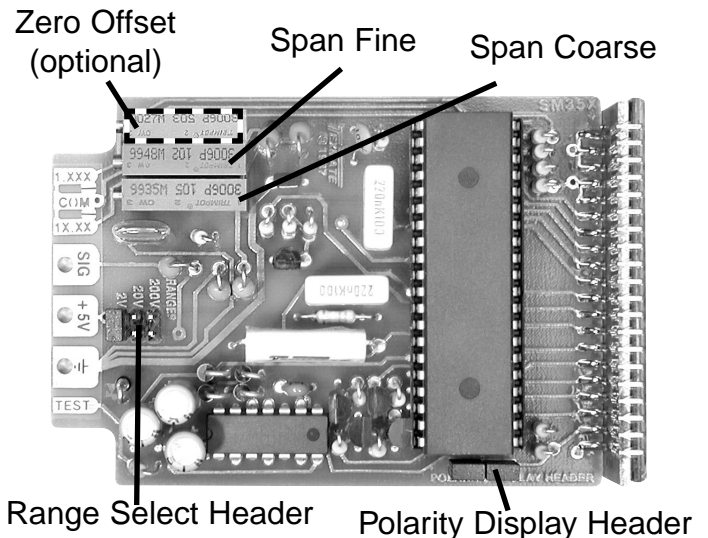

Signal Conditioning Components

ZERO Potentiometer (Pot) Optional
To the Left Front
Turn Clockwise to Increase Reading
The Optional ZERO pot when installed is to the left of the SPAN pots (as viewed from the back of the meter). Typically it enables the displayed reading to be offset ± 1000 counts.

SPAN Potentiometer (Pot)
To the Right Front
Turn Clockwise to Increase Reading
The 15 turn SPAN Fine pot is on the left (as viewed from the back of the meter). Typical adjustment is 10% of the input signal range.

SPAN Potentiometer (Pot)
To the Right Front
Turn Clockwise to Increase Reading
The 15 turn SPAN Coarse pot is on the right side (as viewed from the back of the meter). Typical adjustment is 100% of the input signal range.

RANGE SELECT Header
Range values are marked on the PCB. Three positions are provided. After selecting a new range with the single jumper clip, recalibration is required.

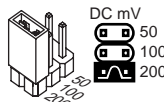

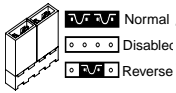

Polarity Display Header

This header allows the Polarity indication to be displayed normally, displayed reversed or to be disabled completely.

Calibration Procedure

CAUTION - ELECTRICAL SHOCK HAZARD See Below.

- 1) Select the F.S. input voltage range by re-positioning the jumper clip on the range select header as indicated by the voltages marked on the PCB.
- 2) Short Signal High Input Pins 4 & 5 to Signal Low Input Pins 8 & 9.
- 3) Adjust **Zero Offset** until the display reads zero.
- 4) Apply F.S. voltage.
- 5) Adjust **Span Coarse & Span Fine** controls; clockwise increases the displayed reading.
- 6) Adjust **Zero Offset** to offset the zero reading as required. **(Re-calibration must be performed after changing ranges).**

CAUTION - ELECTRICAL SHOCK HAZARD All internal parts of the meter may be at the same electrical potential as the input signal and power supply. Do not reposition the signal conditioning components when input voltages are applied. When measuring dangerously high input voltages, extreme care must be taken to insulate the connector pins as well as all metal parts of the meter. A suitable high voltage warning notice should be affixed to those meters where there is any possibility that the meter could be removed from its case, or the internal components accessed, concurrent with the existence of a high voltage input signal.

TB-Kit Screw Connectors

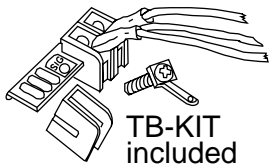

Textmate's individual screw terminal blocks offer a convenient alternative to edge connectors for many applications, allowing complete installation, configuration and calibration without the need for soldering.

Slide each terminal block over the

PCB until the hole aligns. Insert the retaining screw to secure.

Each kit includes: 3 plastic blocks with metal contacts, 4 screws with spade connectors, 1 metal contact and 3 quick disconnects.

Push-On Screw Terminals

They provide the greatest convenience and ease of use

Textmate's exclusive optional Push-On Connectors combine an edge card connector and a 10 position screw terminal block. Push-On Connectors are ordered preconfigured for each specific power supply voltage and each optional power supply available for the SM-Series.



Part Number: CN-PUSH/SM

Optional PCB Edge Connector

PCB Edge Connector

A standard 20-pin edge connector (two rows of 10 pins on 0.156" centers) is used to connect the SM-35 meter. Order part no. CN-L10.

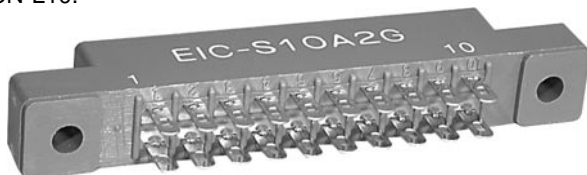

Decimal Point Selection

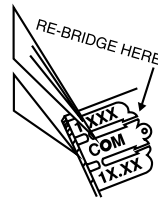

The meter is shipped from the factory with all the decimal points on. To turn off unwanted decimals, use a pair of long-nosed pliers to scrape off the fine tracks connecting decimals to decimal select common (alternatively, use a scalpel or small screwdriver). Reconnect by soldering where shown.

Custom Face Plates



Textmate Produces Thousands of Custom OEM Face Plates

Have Textmate Design and Build a Custom Face Plate to Suit your Next project!

- Custom face plates have a non-recurring artwork charge. A serial number is then assigned to each artwork, to facilitate re-ordering.
- Small Run or One-Off custom face plates incur an installation charge, and are generally printed on a special plastic film, which is then laminated to custom faceplate blanks as required.
- Large Run (250 pieces min): custom face plates are production silk screened, issued a part number, and held in stock for free installation as required by customer orders.
- OEMs may also order Custom Meter Labels, Box Labels Custom Data Sheets and Instruction Manuals.

Slim Bezel Meters That Are Compatible with the SM-35 Series

- AM-20**20 segment LED bargraph, 5V DC power
- CM-35XTL**Less than 1V DC loop drop and 1 Joule energy storage
- CM-35XT**Economical 4-20mA loop-powered meter
- CP-45**Single set point, 4.5 digit BCD comparator controller
- PM-45X**4.5 digit 0.48" LCD DPM
- PM-45XBCD**PM-45X with parallel BCD output
- PM-45XU**Lower cost version of PM-45X
- PM-45L**4.5 digit 0.4" LED DPM
- PM-45LBCD**PM-45L with parallel BCD output
- PM-45LU**Lower cost version of PM-45L
- SP-35X**DC voltage measurement from 3.5V DC to 199.9V DC
- SP-35XMV**DC current measurement with 50, 60 or 100mV shunts
- SP-35XRMS**AC/DC Voltage input
- TM-35**3.5 digit LED, °C or °F, type J and K thermocouples
- TM-35X**3.5 digit LCD, °C or °F, type J and K thermocouples
- PS-505**5V DC Regulated Power Supply, 0.5A Output
- PS-510**5V DC Regulated Power Supply, 1A Output

SM Case Dimensions and Panel Cutouts

The Slim Bezel Case is supplied as standard. If specified at time of ordering, any combination of Twin Mounting and Multiple Array Cases may be substituted at no additional cost. Extra cases may be ordered separately.

STANDARD SLIM BEZEL CASE

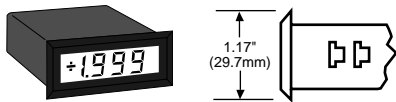

SLIM BEZEL CASE
Standard Black ABS case with matte finish bezel for single unit mounting.
Part No. **SL-CASERED** for LED's
SL-CASECLR for LCD's

OPTIONAL TWIN MOUNTING OR MULTIPLE ARRAY CASES

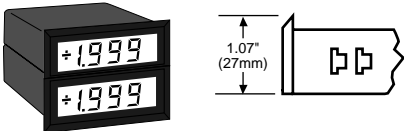

END MOUNT CASE
Same styling as Slim Bezel case but with bottom edge of bezel removed. Two End Mount cases can be twin mounted in a single cutout.
Part No. **EM-CASERED** for LED's
EM-CASECLR for LCD's

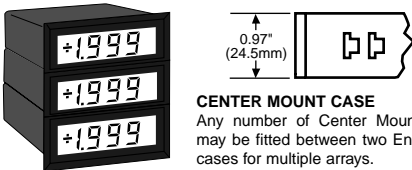

CENTER MOUNT CASE
Any number of Center Mount cases may be fitted between two End Mount cases for multiple arrays.
Part No. **CM-CASERED** for LED's
CM-CASECLR for LCD's

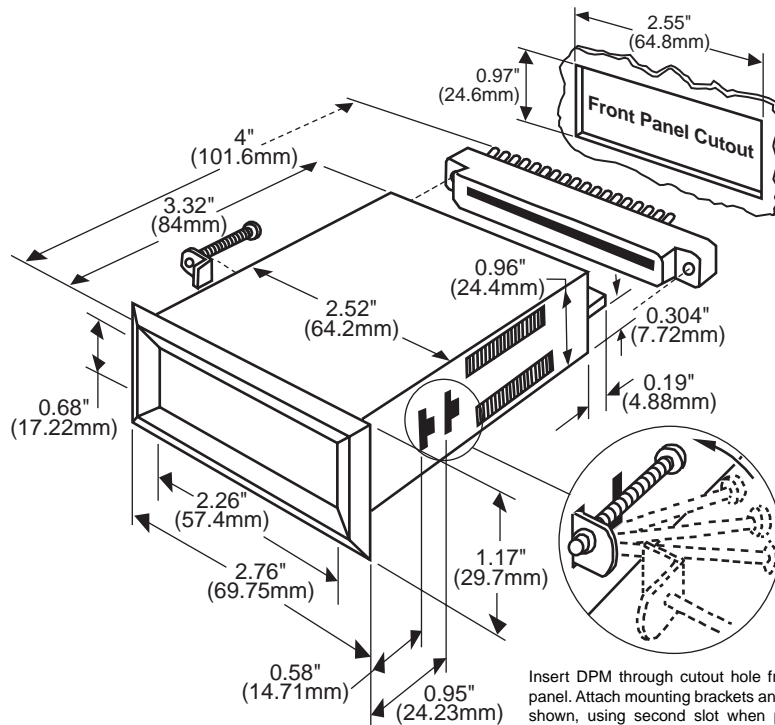

Insert DPM through cutout hole from front of panel. Attach mounting brackets and screws as shown, using second slot when panel thickness is greater than 1/4 inch. Tighten screws against rear of panel.

Ordering Information

Standard Options for this Model Number

Part Number	Description
► BASIC MODEL NUMBER	Includes plug in type screw terminals, standard display and standard power supply unless optional versions are ordered.
SM-35X	3.5 digit LCD, 2/20/200VDC, 5VDC Pwr

Special Options and Accessories

Part Number	Description
► SPECIAL OPTIONS (Specify Inputs & Req. Reading)	
HD-CHANGE	Range change from the standard input as shown in BOLD type
VO-50K	Zero offset potentiometer 50k

WARRANTY

Texmate warrants that its products are free from defects in material and workmanship under normal use and service for a period of one year from date of shipment. Texmate's obligations under this warranty are limited to replacement or repair, at its option, at its factory, of any of the products which shall, within the applicable period after shipment, be returned to Texmate's facility, transportation charges pre-paid, and which are, after examination, disclosed to the satisfaction of Texmate to be thus defective. The warranty shall not apply to any equipment which shall have been repaired or altered, except by Texmate, or which shall have been subjected to misuse, negligence, or accident. In no case shall Texmate's liability exceed the original purchase price. The aforementioned provisions do not extend the original warranty period of any product which has been either repaired or replaced by Texmate.

CB-FS35 Non-Std Range and Scale Changes for SM-35 series

► ACCESSORIES

CN-L10	Edge Connector with Solder eyelet, 10 Pin Dual
CN-PUSH/SM	Push-On Screw Terminal Block Connector
TB-KIT	Replacement Terminal Block Connector Kit (3)
SL.CASECLR	Slim Bezel Case, Clear Faceplate w/Mtg Hrdwre
CM.CASECLR	Ctr. Mount Case, Clear Faceplate w/Mtg Hrdwre
EM.CASECLR	End Mount Case, Clear Faceplate w/Mtg Hrdwre
PS-505	.5V DC Regulated Power Supply, 0.5A Output
PS-510	.5V DC Regulated Power Supply, 1A Output

Prices subject to change without notice.

USER'S RESPONSIBILITY

We are pleased to offer suggestions on the use of our various products either by way of printed matter or through direct contact with our sales/application engineering staff. However, since we have no control over the use of our products once they are shipped, **NO WARRANTY WHETHER OF MERCHANTABILITY, FITNESS FOR PURPOSE, OR OTHERWISE** is made beyond the repair, replacement, or refund of purchase price at the sole discretion of Texmate. Users shall determine the suitability of the product for the intended application before using, and the users assume all risk and liability whatsoever in connection therewith, regardless of any of our suggestions or statements as to application or construction. In no event shall Texmate's liability, in law or otherwise, be in excess of the purchase price of the product.

Texmate cannot assume responsibility for any circuitry described. No circuit patent or software licenses are implied. Texmate reserves the right to change circuitry, operating software, specifications, and prices without notice at any time.



995 Park Center Drive • Vista, CA 92081-8397
Tel: 1-760-598-9899 • USA 1-800-839-6283 • That's 1-800-TEXMATE
Fax: 1-760-598-9828 • Email: sales@texmate.com • Web: www.texmate.com

Texmate has facilities in Japan, New Zealand, Taiwan, and Thailand. We also have authorized distributors throughout the USA and in 28 other countries.

For product details visit www.texmate.com

Local Distributor Address