



Optional super bright LEDs



Optional Green LED Display

## UM-35-DCV

### 2/20/200 Volt DC Meter

### 3 1/2 DIGIT with 0.56" LEDs

### in a NEMA type 1 Style Case

**A cost-effective Utility Meter for General Purpose Single or Differential DC Voltage Measurement.**

### General Features

The UM-35-DCV is a very reliable utility DC voltage measuring meter with three built-in ranges of 2V/20V/200V. It is a cost-effective solution to most DC voltage measuring applications since it may be used to measure single-ended as well as differential signals and is easily scaled to any desired process engineering unit.

### Typical Application Connections

**DC Volts Single-ended** measurement with a Resolution of 100 milliVolt.

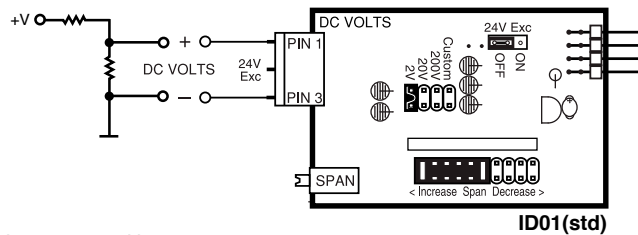

**DC Volts Differential** measurement with a Resolution of 100 milliVolt.

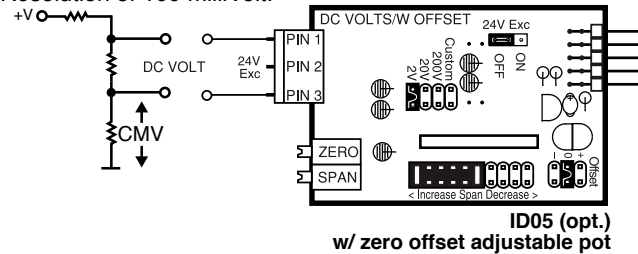

Max CMV (common mode voltage) is 50V.\*  
\*Because CMV is common with meter ground, higher CMV inputs to a max of 1KV, require mechanical isolation of all contactable meter parts.

### Specifications

**Input Configuration:** .....Single-ended, however the isolated power supply enables differential measurements up to a maximum common mode of 50V.\*  
Optional zero pot to offset the reading displayed.  
(See Ordering Information)

**Full Scale Ranges:**.....Three header selectable ranges of  $\pm 2V$ ,  $\pm 20V$  and  $\pm 200V$  DC

**Input Impedance:**.....1M $\Omega$  minimum

**A/D Converter:**.....12 Bit Dual Slope

**Accuracy:** ..... $\pm(0.05\%$  of reading plus 2 counts)

**Temperature Coefficient:** 100ppm/ $^{\circ}C$  (Typical)

**Warm Up Time:**.....2 minutes to specified accuracy

**Conversion Rate:**.....3 conversions per second (Typical)

**Display:**.....3 1/2 digit 0.56" Red LED display (std), Green or Super Bright Red are optional. Range -1999 to 1999 counts.

**Decimal Selection:** .....Header under face plate, X•X•X•X•

**Overrange Indication:** .....1 (MSD) displayed with all other digits blank

**Power Supply (std):** .....120/240V AC, 50/60/400Hz. approx 1.5W.  
(Optional) VO-DC/ISO....Isolated Switcher. 9 to 36V DC/12 to 24V AC

**Operating Temperature:**...-10 to 50  $^{\circ}C$

**Storage Temperature:** .....-20 to 70  $^{\circ}C$ .

**Relative Humidity:** .....95% (non-condensing)

**Case Dimensions:**.....Bezel 3.78"Wx1.89"H (96mm x 48mm)  
Depth behind bezel 3.36" (83.5mm) Plus 0.5 to .9" (12.7 to 22.8mm) depending on connector used.

**Weight:**.....NW. 12oz (0.34kg)

15.6oz (0.44kg). when packed.

### UM-Series utility meters for switchboard and process indication

- UM-35-ACA** .....AC amps, Scaled or True RMS, (1 or 5 Amp internal shunt), 3.5 digit.
- UM-35-ACV** .....DC Volts  $\pm 2V/\pm 20V/\pm 200V$  DC header selectable ranges, 3.5 digit.
- UM-35-DCA** .....DC mV  $\pm 20mV/\pm 50mV/\pm 100mV/\pm 200mV$  header selectable ranges, 3.5 digit
- UM-35-DCV** .....DC Volts  $\pm 2V/\pm 20V/\pm 200V$  DC header selectable ranges, 3.5 digit.
- UM-40-ACA** .....AC amps, Scaled or True RMS, (1 or 5 Amp internal shunt), 4.0 digit.
- UM-40-ACV** .....AC volts, Scaled or True RMS. 199.9V AC/700V AC header selectable ranges, 4.0 digit.
- UM-45-DCA** .....DC mV  $\pm 20mV/\pm 50mV/\pm 100mV/\pm 200mV$  header selectable ranges, 4.5 digit
- UM-45-DCV** .....DC Volts  $\pm 2V/\pm 20V/\pm 200V$  DC Header selectable ranges, 4.5 digit.

- UM-35-CL** .....Process 4 to 20mA (100.0), optional 24V DC excitation ,easily user scalable in engineering units from -1999 to +1999. 3.5 digit
- UM-35-HZ** .....15Hz to 199.9Hz or optional 40Hz to 400Hz up to 500V AC , 3.5 digit.
- UM-35-Pressure**.....Pressure, strain gage and load cell, 4 and 6 wire, 5V DC excitation, Header Selectable Sensitivity 2mV/V, 5mV/V, 10mV/V, 20mV/V, 3.5 digit
- UM-35-JF** .....J thermocouple input, 1 $^{\circ}$  resolution, order  $^{\circ}C$  or  $^{\circ}F$ , 3.5 digit
- UM-35-KF** .....K thermocouple input, 1 $^{\circ}$  resolution, order  $^{\circ}C$  or  $^{\circ}F$ , 3.5 digit
- UM-35-RTD/F** ..100 $\Omega$  platinum RTD, 3 or 4 wire, order  $^{\circ}C$  or  $^{\circ}F$  and 0.1 $^{\circ}$  or 1 $^{\circ}$ , 3.5 digit
- UM-45-CL** .....Process 4 to 20mA (100.0), optional 24V DC excitation ,easily user scalable in engineering units from -19999 to +19999. 4.5 digit

## Component Layout

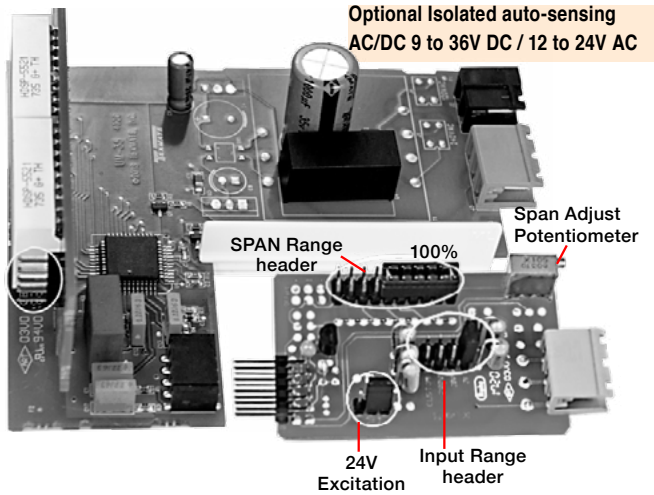

Optional Isolated auto-sensing  
AC/DC 9 to 36V DC / 12 to 24V AC

Decimal selection is made by moving the jumper to the indicated position on the header for the decimal required on the front of the display board.

## Decimal Point Selection

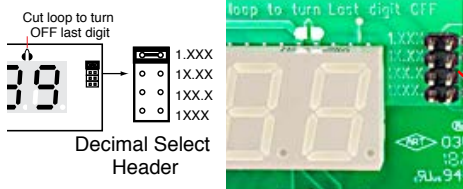

To open meter, insert a flat head screwdriver or similar instrument in both slots on the side of the cover and pry open. The UM-Series meters slide out from the front of the case as a complete assembly.

## Signal Conditioning Components

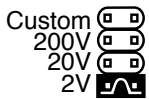

### INPUT RANGE Header

Range values are marked on the PCB. After selecting a new range with the single jumper clip, recalibration is required.



### SPAN Potentiometer (Pot)

To the Right Front  
Turn Clockwise to Increase Reading

The 15 turn SPAN pot is always on the right side (as viewed from the front of the meter). Typical adjustment is 100% of the input signal range.



### ZERO Potentiometer (Pot)

To the Left Front  
Turn Clockwise to Increase Reading

The Optional ZERO pot when installed is always to the left of the SPAN pot (as viewed from the front of the meter). Typically it enables the displayed reading to be offset  $\pm 100$  counts.

## Optional Face Plate Descriptors



To customize the face plate, clear adhesive label containing various popular descriptors may be ordered. Choose the descriptor desired, peel off the adhesive backing and align the descriptor in the center right of the faceplate.

P.N.: DU-CASEDES

## Calibration Procedure

1. Select the required full scale voltage range by repositioning the jumper clip on the Range Select Header. A range of 2, 20 or 200V DC full scale may be selected.
2. Apply an input of 0 volts. The meter will autozero and display 0000. If the zero needs to be offset, order the ID05 option and adjust Zero Offset pot until the meter reads 0000.
3. Apply a known high input signal that is within the full scale voltage range selected.
4. Adjust the Span Pot until the meter displays the required reading for the signal being applied. e.g. 1VDC=1.000
5. The UM-35-DCV is now calibrated and ready for use. (Whenever you select a new range, you must re-calibrate to meet the specified accuracy.)

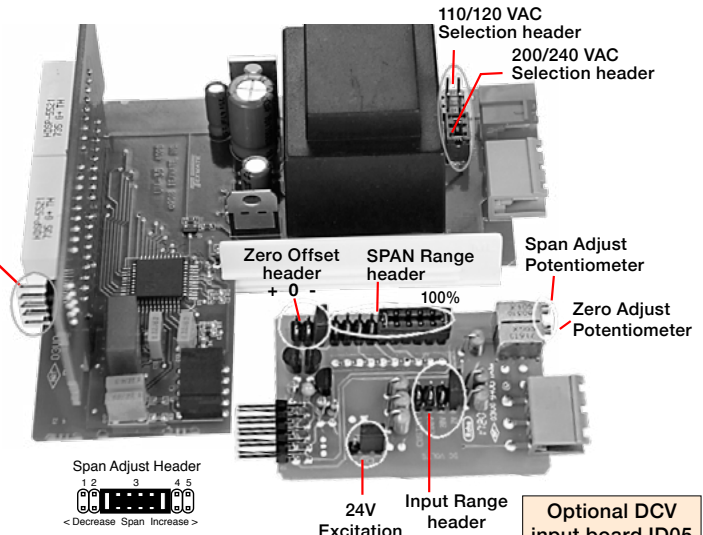

SPAN Adjust Header position	1	2	3	4	5
SPAN Pot %	10%	10%	10%	10%	10%
Signal Span %	20%	40%	60%	80%	100%

Optional DCV input board ID05 with Zero Adjust Potentiometer

## Connector Pinouts

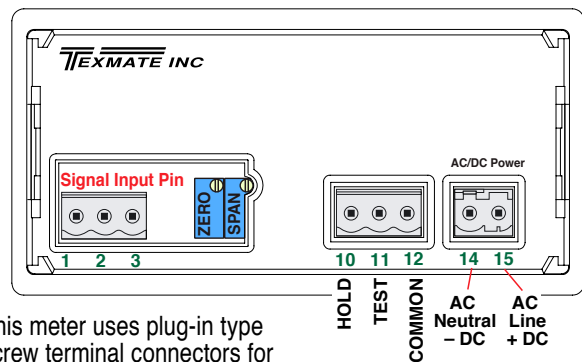

This meter uses plug-in type screw terminal connectors for all connections.

## Connectors

This meter uses plug-in type screw terminal connectors for all input and output connections. The power supply connections (pins 14 and 15) have a unique plug and socket outline to prevent cross connection. The main board uses standard right-angled connectors.

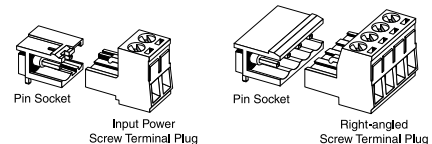

**WARNING:** AC and DC input signals and power supply voltages can be hazardous. Do Not connect live wires to screw terminal plugs, and do not insert, remove or handle screw terminal plugs with live wires connected.

## UM Case Dimensions and Panel Cutouts

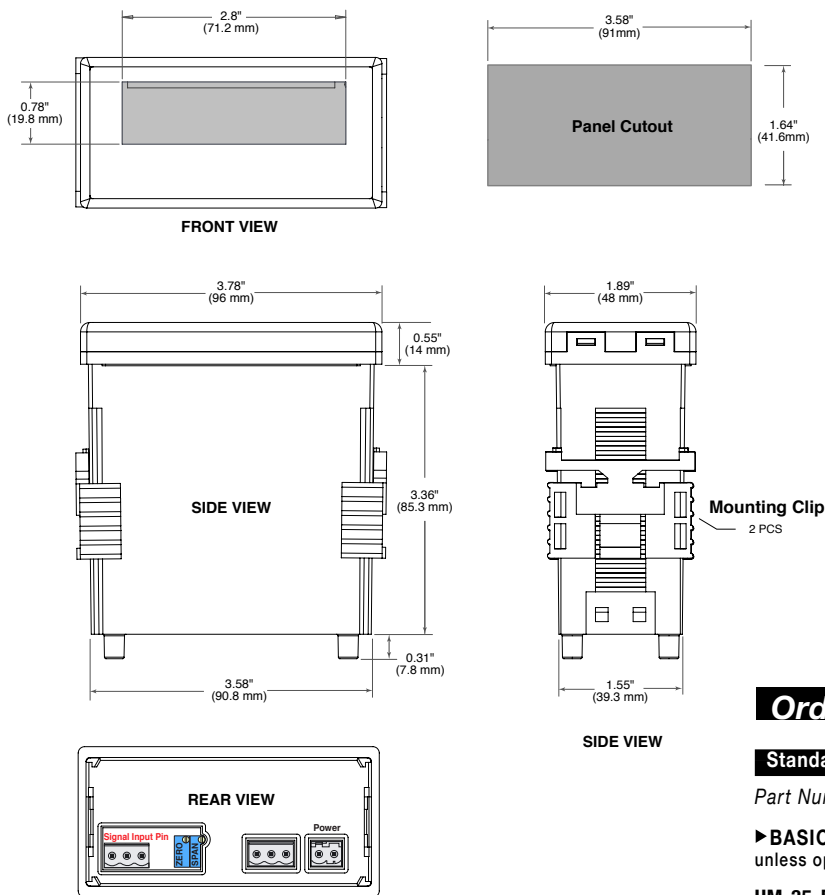

## Warranty and User's Responsibility

### WARRANTY

Texmate warrants that its products are free from defects in material and workmanship under normal use and service for a period of one year from date of shipment. Texmate's obligations under this warranty are limited to replacement or repair, at its option, at its factory, of any of the products which shall, within the applicable period after shipment, be returned to Texmate's facility, transportation charges pre-paid, and which are, after examination, disclosed to the satisfaction of Texmate to be thus defective. The warranty shall not apply to any equipment which shall have been repaired or altered, except by Texmate, or which shall have been subjected to misuse, negligence, or accident. In no case shall Texmate's liability exceed the original purchase price. The aforementioned provisions do not extend the original warranty period of any product which has been either repaired or replaced by Texmate.

### USER'S RESPONSIBILITY

We are pleased to offer suggestions on the use of our various products either by way of printed matter or through direct contact with our sales/application engineering staff. However, since we have no control over the use of our products once they are shipped, NO WARRANTY WHETHER OF MERCHANTABILITY, FITNESS FOR PURPOSE, OR OTHERWISE is made beyond the repair, replacement, or refund of purchase price at the sole discretion of Texmate. Users shall determine the suitability of the product for the intended application before using, and the users assume all risk and liability whatsoever in connection therewith, regardless of any of our suggestions or statements as to application or construction. In no event shall Texmate's liability, in law or otherwise, be in excess of the purchase price of the product.

Texmate cannot assume responsibility for any circuitry described. No circuit patent or software licenses are implied. Texmate reserves the right to change circuitry, operating software, specifications, and prices without notice at any time.

## Ordering Information

### Standard Options for this Model Number

Part Number	Description
<b>► BASIC MODEL NUMBER</b> standard display and standard power supply unless optional versions are ordered.	
<b>UM-35-DCV</b> ..... DPM, $\pm 2/20/200V$ DC Header selectable (ID01) .....	with 50K pot Offset option (ID05) .....
<b>► DISPLAY</b>	
<b>DR</b> ..... <b>0.56" Red LEDs</b> .....	UM-BRIGHT.....Super bright Red LEDs, 0.56 inch high .....
	UM-GREEN.....Green LEDs, 0.56 inch high .....
<b>► POWER SUPPLY</b>	
<b>PS6</b> .....	100/120 or 200/240VAC 60/50Hz User selectable .....
<b>PS7</b> .....	Isolated auto-sensing AC/DC 9 to 36V DC/12 to 24V AC .....

### Special Options and Accessories

Part Number	Description
<b>► SPECIAL OPTIONS (Specify Inputs or Outputs &amp; Req. Reading)</b>	
<b>ZR</b> .....	Input Range Change to another Standard Range .....
<b>ZRS-SMUM</b> .....	Non-standard range change and/or Scale change .....

### ► ACCESSORIES

<b>OP-N4X/96X48</b> ..	.96x48mm clear lockable front cover NEMA 4X, splash proof
<b>CASE.RPUM</b> .. .	Case: Replacement with Accessories .....
<b>ART-FS-S/D</b> .. .	NRC for Artwork & set-up Custom Faceplate and/or Descriptor
<b>ART-FS-001</b> .. .	Produce & Install Custom Faceplate per meter - 1 color no-min
<b>ART-FS-002</b> .. .	Produce & Install Custom Faceplate per meter - 2 color no-min
<b>ART-FS-003</b> .....	Produce & Install Custom Faceplate per meter - 3 color no-min
<b>DU-CASEDES</b> .....	Clear adhesive descriptors label for face plate .....

## Custom Face Plates

Texmate Produces Thousands of Custom OEM Face Plates. Have Texmate Design and produce a Custom Face Plate for your next project!

- Custom face plates have a non-recurring artwork charge. A serial number is then assigned to each artwork to facilitate reordering.

*UM-35-DCV Technical Manual Copyright © 2018 Texmate Inc. All rights reserved. Published by: Texmate Inc. USA. Information in this Technical Manual is subject to change without notice due to correction or enhancement. The information described in this manual is proprietary to Texmate, Inc. and may not be copied, reproduced or transmitted, in whole or in part, in connection with the design, manufacture, or sale of apparatus, device or private label product without the express written consent of Texmate, Inc.*

## Clear Lockable Water-proof Cover

The clear lockable cover is designed to be dust and waterproof to NEMA-4X, IP65 standards. The assembly consists of a base and a cover with a cam hinge and key-lock fastening mechanism. An O-ring, or neoprene gasket forms a seal between the base and the panel. The cam hinge prevents the cover from closing when opened until pushed closed. The cover has a tapered recess that, when closed, forms a seal with a tapered spigot on the base. A key-lock employs a cam locking device to force the spigot into the recess, ensuring seal integrity. A safety catch keeps the cover closed even when the key is removed, and the keyhole can be used to attach a safety seal clip, preventing unauthorized opening.

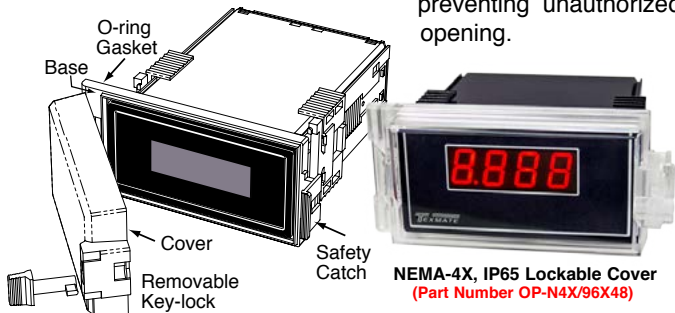

NEMA-4X, IP65 Lockable Cover  
(Part Number OP-N4X/96X48)



1934 Kellogg Ave., Carlsbad, CA 92008  
Tel: 1-760-598-9899 • 1-800-TEXMATE  
Fax: 1-760-598-9828 • Email: orders@texmate.com