



Optional super bright LEDs



Optional Green Digit Display

Optional Custom Faceplate

UM-35-TC-JC/JF UM-35-TC-KC/KF

Thermocouple Temperature Meter 3 1/2 DIGIT with 0.56" LEDs in a NEMA type 1 Style Case

Cost effective utility temperature meter J or K thermocouple with 1° or 0.1° resolution pre-calibrated in °F or °C

General Features

The UM-35-TC-JC&JF and UM-35-TC-KC&KF are economical thermocouple input temperature meters with a resolution of 1°. The meters are ordered factory calibrated for either a °F or °C indication. Automatic cold junction compensation, Thermocouple Break Detection, Display Hold and Display Test functions are provided as standard features.

Typical Application Connections

J type Thermocouple

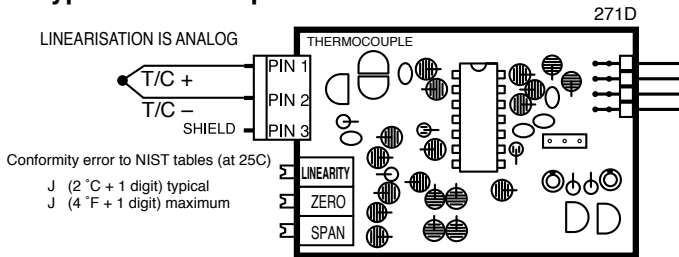

K type Thermocouple

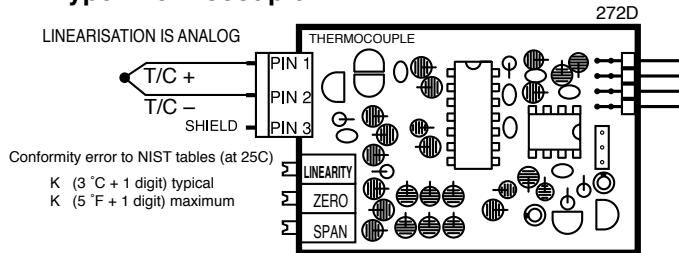

Specifications

Input Configuration:.....Differential.

Full Scale Ranges:UM-35-TC-JC 0 to 760°C
UM-35-TC-JF 0 to 1400°F
UM-35-TC-KC 0 to 1260°C
UM-35-TC-KF 0 to 1999°F

Lead Resistance Effects: 20µV per 10Ω of lead resistance
Cold Junction

Compensation:Automatic ±0.1°C/°C (Cal. @25°C)

Input Protection:.....25V AC/DC

A/D Converter:.....12 Bit Dual Slope

Conformity Error(at 25°C): UM-35-TC-JC ±(2°C + 1 digit) typical
UM-35-TC-JF ±(4°F + 1 digit) maximum
UM-35-TC-KC ±(3°C + 1 digit) typical
UM-35-TC-KF ±(5°F + 1 digit) maximum

Temperature Coefficient: 100 ppm/°C (Typical)

Warm Up Time:2 minutes to specified accuracy

Conversion Rate:.....3 conversions per second (Typical)

Display:.....3 1/2 digit 0.56" Red LED display (std),
Green or Super Bright Red are optional.
Range 0 to 1999 counts.

Decimal Selection:Header under face plate, X•X•X•X•

Overrange/Open

Thermocouple Indication: 1 (MSD) displayed all other digits blank

Power Supply (PS6 std): 120/240V AC, 50/60/400 Hz. approx 1.5W.
(PS7 opt) ..Isolated Switcher. 9 to 36V DC/12 to 24V AC
(PS8 opt) ..5 VDC/200mA

Operating Temperature: ..-10 to 50 °C

Storage Temperature:-20 to 70 °C.

Relative Humidity:95% (non-condensing)

Case Dimensions:Bezel 3.78"Wx1.89"H (96mm x 48mm)
Depth behind bezel 3.36" (83.5mm) Plus
0.5 to .9" (12.7 to 22.8mm) depending on
connector used.

Weight:NW. 12oz (0.34kg) 1
5.6oz (0.44kg). when packed.

UM-Series utility meters for switchboard and process indication

UM-35-ACAAC amps, Scaled or True RMS, (1 or 5 Amp internal shunt), 3.5 digit.

UM-35-ACVAC volts, Scaled or True RMS. 199.9V AC/700V AC header selectable ranges, 3.5 digit.

UM-35-DCADC mV ±20mV/±50mV/±100mV/±200mV header selectable ranges, 3.5 digit

UM-35-DCVDC Volts ±2V/±20V/±200V DC header selectable ranges, 3.5 digit.

UM-40-ACAAC amps, Scaled or True RMS, (1 or 5 Amp internal shunt), 4.0 digit.

UM-40-ACVAC volts, Scaled or True RMS. 199.9V AC/700V AC header selectable ranges, 4.0 digit.

UM-45-DCADC mV ±20mV/±50mV/±100mV/±200mV header selectable ranges, 4.5 digit

UM-45-DCVDC Volts ±2V/±20V/±200V DC Header selectable ranges, 4.5 digit.

UM-35-CLProcess 4 to 20mA (100.0), easily user scalable in engineering units from -1999 to +1999. 3.5 digit

UM-35-HZ15Hz to 199.9Hz or optional 40Hz to 400Hz up to 500V AC , 3.5 digit.

UM-35-SGPressure, strain gage and load cell, 4 wire, 5V/10V DC excitation, Header Selectable Sensitivity 2mV/V or 20mV/V, 3.5 digit

UM-35-JFJ thermocouple input, 1° resolution, order °C or °F, 3.5 digit

UM-35-KFK thermocouple input, 1° resolution, order °C or °F, 3.5 digit

UM-35-RTD/F.. 100Ω platinum RTD, 3 or 4 wire, order °C or °F and 0.1° or 1°, 3.5 digit

UM-45-CLProcess 4 to 20mA (100.0), easily user scalable in engineering units from -19999 to +19999. 4.5 digit

Calibration Procedure

1. Connect a J or K Thermocouple Simulator to the input of the appropriate model and calibrate according to the Calibration Table. If your simulator does not output the specific values shown in the Table, then set the simulator to the next nearest value and make the calibration adjustments to that value instead of the values in the Table.
2. **LINEARITY.** The LINEARITY Pot is calibrated at the factory and does not normally need to be re-calibrated by the user. If Linearity must be re-calibrated, connect a voltmeter between the shield and calibration Point "A" (shown on the component layout), then follow step 3.

Calibration Table

UM - model no.	UM-35JF	UM-35JC	UM-35KF	UM-35KC
Thermocouple Type Can not be changed	J	J	K	K
Temperature Scale Re-calibrate to change F/C	°F	°C	°F	°C
3. Adjust Linearity Pot until the voltage at calibration Point "A" is exactly 1.000V with the simulator output set to:	1400°F	760°C	1990°F	1260°F
4. Adjust Zero Pot so display matches TC simulator with output set to:	0°F	0°C	0°F	0°C
5. Adjust Span Pot so display matches TC simulator with output set to:	1400°F	760°C	1990°F	1260°F

6. The J meter is now calibrated and ready for use.

Signal Conditioning Components

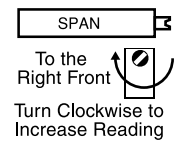

SPAN Potentiometer (Pot)

The 15 turn SPAN pot is always on the right side (as viewed from the front of the meter). Typical adjustment is 100% of the input signal range.

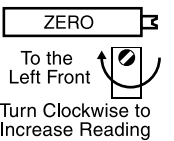

ZERO Potentiometer (Pot)

The Optional ZERO pot when installed is always to the left of the SPAN pot (as viewed from the front of the meter). Typically it enables the displayed reading to be offset ± 100 counts.

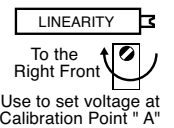

LINEARITY Potentiometer (Pot)

The Linearity pot is used to set the voltage at the calibration Point "A". The Linearity Pot is adjusted at the factory and does not normally need to be re-adjusted by the user.

Optional Face Plate Descriptors

AC	V	KV	KVAR	mVA	Hz	RPM
V	mV	min	PP	P	C	Case
DC	A	mA	PSIG	mS	K	psi
KW	W	KWH	pH	%	K	RPM
KA	mbar	mA	MW	KA	RPS	KW
nWs	µm	KW/S	I	Usec	ml	cm
DRP	mm/s	l/min	mm	kg/sec	lbs	mm
BT	bars	min	mm	Mwatt	µV	dB

To customize the face plate, clear adhesive label containing various popular descriptors may be ordered. Choose the descriptor desired, peel off the adhesive backing and align the descriptor in the center right of the faceplate.

P.N.: DU-CASEDES

Component Layout

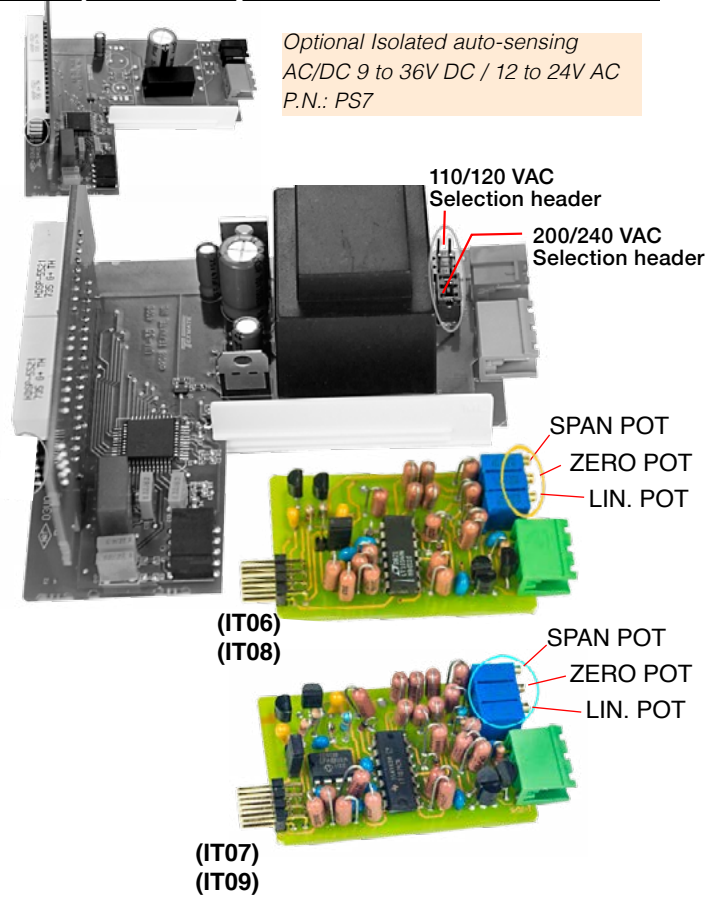

Connector Pinouts

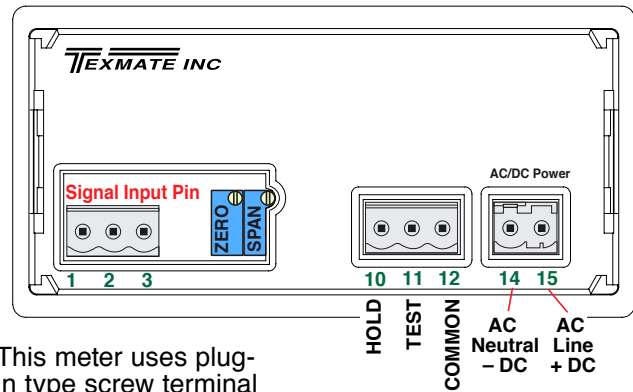

This meter uses plug-in type screw terminal connectors for all connections.

Connectors

This meter uses plug-in type screw terminal connectors for all input and output connections. The power supply connections (pins 14 and 15) have a unique plug and socket outline to prevent cross connection. The main board uses standard right-angled connectors.

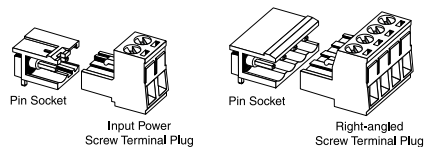

WARNING: AC and DC input signals and power supply voltages can be hazardous. Do Not connect live wires to screw terminal plugs, and do not insert, remove or handle screw terminal plugs with live wires connected.

UM Case Dimensions and Panel Cutouts

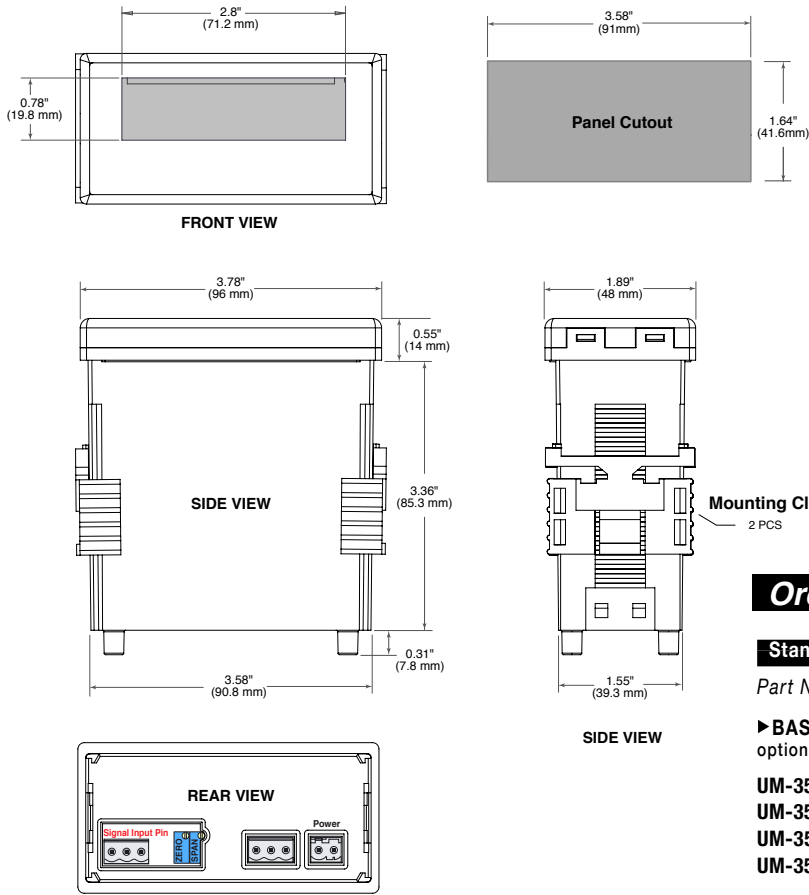

Clear Lockable Water-proof Cover

The clear lockable cover is designed to be dust and waterproof to NEMA-4X, IP65 standards. The assembly consists of a base and a cover with a cam hinge and key-lock fastening mechanism. An O-ring, or neoprene gasket forms a seal between the base and the panel. The cam hinge prevents the cover from closing when opened until pushed closed. The cover has a tapered recess that, when closed, forms a seal with a tapered spigot on the base. A key-lock employs a cam locking device to force the spigot into the recess, ensuring seal integrity. A safety catch keeps the cover closed even when the key is removed, and the keyhole can be used to attach a safety seal clip,

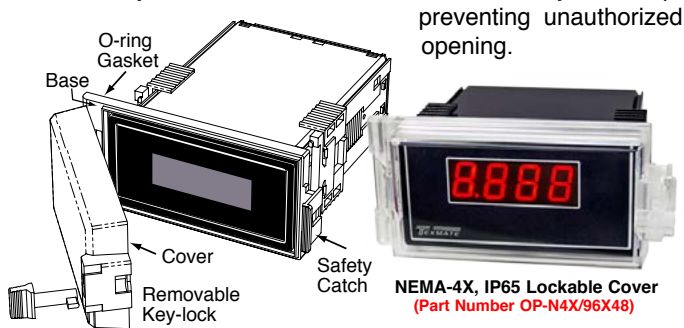

Warranty and User's Responsibility

WARRANTY

Texmate warrants that its products are free from defects in material and workmanship under normal use and service for a period of one year from date of shipment. Texmate's obligations under this warranty are limited to replacement or repair, at its option, at its factory, of any of the products which shall, within the applicable period after shipment, be returned to Texmate's facility, transportation charges pre-paid, and which are, after examination, disclosed to the satisfaction of Texmate to be thus defective. The warranty shall not apply to any equipment which shall have been repaired or altered, except by Texmate, or which shall have been subjected to misuse, negligence, or accident. In no case shall Texmate's liability exceed the original purchase price. The aforementioned provisions do not extend the original warranty period of any product which has been either repaired or replaced by Texmate.

USER'S RESPONSIBILITY

We are pleased to offer suggestions on the use of our various products either by way of printed matter or through direct contact with our sales/application engineering staff. However, since we have no control over the use of our products once they are shipped, NO WARRANTY WHETHER OF MERCHANTABILITY, FITNESS FOR PURPOSE, OR OTHERWISE is made beyond the repair, replacement, or refund of purchase price at the sole discretion of Texmate. Users shall determine the suitability of the product for the intended application before using, and the users assume all risk and liability whatsoever in connection therewith, regardless of any of our suggestions or statements as to application or construction. In no event shall Texmate's liability, in law or otherwise, be in excess of the purchase price of the product. Texmate cannot assume responsibility for any circuitry described. No circuit patent or software licenses are implied. Texmate reserves the right to change circuitry, operating software, specifications, and prices without notice at any time.

Ordering Information

Standard Options for this Model Number

Part Number	Description
► BASIC MODEL NUMBER tandard display and standard power supply unless optional versions are ordered.	
UM-35-TC-JF...	Thermocouple, Type J in °F (IT06)
UM-35-TC-JC...	Thermocouple, Type J in °C (IT08)
UM-35-TC-KF...	Thermocouple, Type K in °F (IT07)
UM-35-TC-KC ..	Thermocouple, Type K in °C (IT09)

► DISPLAY

DR	0.56" Red LEDs
UM-BRIGHT	Super bright Red LEDs, 0.56 inch high
UM-GREEN	Green LEDs, 0.56 inch high

► POWER SUPPLY

PS6	100/120 or 200/240VAC 60/50Hz User selectable
PS7	Isolated auto-sensing AC/DC 9 to 36V DC/12 to 24V AC
PS8	5 VDC/200mA

Special Options and Accessories

Part Number	Description
► SPECIAL OPTIONS (Specify Inputs & Req. Reading)	
ZR	Input Range Change to another Standard Range
ZRS-SMUM	Non-standard range change and/or Scale change

► ACCESSORIES

OP-N4X/96X48	.96x48mm clear lockable front cover NEMA 4X, splash proof
CASE.RPUM ..	Case: Replacement with Accessories
ART-NRC-DEC	NRC for Artwork & set-up Custom Faceplate and/or Descriptor
ART-FS1	Produce & Install Custom Faceplate per meter - 1 color no-min
ART-FS2	Produce & Install Custom Faceplate per meter - 2 color no-min
ART-FS3	Produce & Install Custom Faceplate per meter - 3 color no-min
DU-CASEDES	Clear adhesive descriptors label for face plate

Custom Face Plates

Texmate Produces Thousands of Custom OEM Face Plates. Have Texmate Design and produce a Custom Face Plate for your next project!

• Custom face plates have a non-recurring artwork charge. A serial number is then assigned to each artwork to facilitate reordering.

UM-35-TC-JC/JF and UM-35-TC-KC/KF Technical Manual Copyright © 2019 Texmate Inc. All rights reserved. Published by: Texmate Inc. USA. Information in this Technical Manual is subject to change without notice due to correction or enhancement. The information described in this manual is proprietary to Texmate, Inc. and may not be copied, reproduced or transmitted, in whole or in part, in connection with the design, manufacture, or sale of apparatus, device or private label product without the express written consent of Texmate, Inc.



1934 Kellogg Ave., Carlsbad, CA 92008
Tel: 1-760-598-9899 • 1-800-TEXMATE
Fax: 1-760-598-9828 • Email: orders@texmate.com