



Optional super bright LEDs



Optional Green Digit Display

Optional Custom Faceplate



UM-35-HZ

AC Line Frequency

3 1/2 DIGIT with 0.56" LEDs

in a NEMA type 1 Style Case

An cost-effective meter for 15.0 to 199.9Hz AC line frequency measurement.

General Features

The UM-35-HZ is a cost-effective, utility, AC line frequency measuring meter with a standard range of 15.0Hz to 199.9Hz or an optional range of 40Hz to 400Hz. The unique resistively isolated differential input structure allows safe phase to phase line frequency measurements in multi phase systems.

Typical Application Connections

AC Line Frequency measurement in Single-phase Systems.

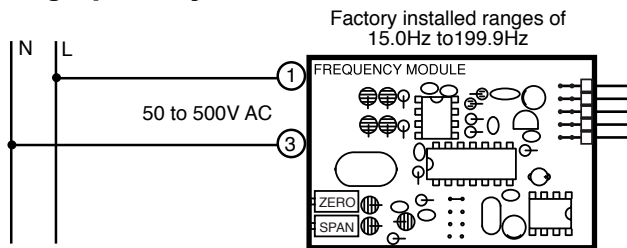

AC Phase to Phase Line Frequency measurement in Multi-phase Systems.

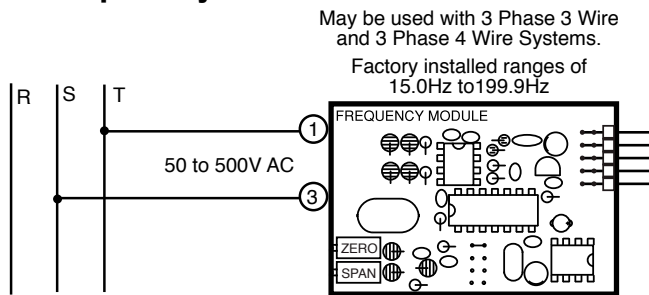

Specifications

- Input Configuration:**.....Differential with Frequency to Voltage converter. Inputs resistively isolated to 1400V from the internal ground of meter by 1.94MΩ, so that phase to phase measurements up to 500V AC can be safely made.
- Full Scale Ranges:**Factory installed range of 15.0Hz to 199.9Hz.
- Input Impedance:**.....4MΩ
- A/D Converter:**.....12 Bit Dual Slope
- Accuracy:**.....±(0.05% of reading + 2 counts)
- Temperature Coefficient:** 100 ppm/°C (Typical)
- Warm Up Time:**.....2 minutes to specified accuracy
- Conversion Rate:**.....3 conversions per second (Typical)
- Display:**.....3 1/2 digit 0.56" Red LED display (std), Green or Super Bright Red are optional. Range 0 to 1999 counts.
- Decimal Selection:**Header under face plate, X·X·X·X·
- Over-range Indication:**....1 (MSD) displayed all other digits blank
- Power Supply (std):**.....120/240V AC, 50/60/400 Hz. approx 1.5W.
(Optn) VO-DC/ISO.....Isolated Switcher. 9 to 36V DC/12 to 24V AC
- Operating Temperature:**...-10 to 50 °C
- Storage Temperature:**.....-20 to 70 °C.
- Relative Humidity:**.....95% (non-condensing)
- Case Dimensions:**Bezel 3.78"Wx1.89"H (96mm x 48mm)
Depth behind bezel 3.36" (83.5mm) Plus 0.5 to .9" (12.7 to 22.8mm) depending on connector used.
- Weight:**NW. 12oz (0.34kg)
15.6oz (0.44kg). when packed.

UM-Series utility meters for switchboard and process indication

- UM-35-ACA**AC amps, Scaled or True RMS, (1 or 5 Amp internal shunt), 3.5 digit.
- UM-35-ACV**AC volts, Scaled or True RMS. 199.9V AC/700V AC header selectable ranges, 3.5 digit.
- UM-35-DCA**DC mV ±20mV/±50mV/±100mV/±200mV header selectable ranges, 3.5 digit
- UM-35-DCV**DC Volts ±2V/±20V/±200V DC header selectable ranges, 3.5 digit.
- UM-40-ACA**AC amps, Scaled or True RMS, (1 or 5 Amp internal shunt), 4.0 digit.
- UM-40-ACV**AC volts, Scaled or True RMS. 199.9V AC/700V AC header selectable ranges, 4.0 digit.
- UM-45-DCA**DC mV ±20mV/±50mV/±100mV/±200mV header selectable ranges, 4.5 digit
- UM-45-DCV**DC Volts ±2V/±20V/±200V DC Header selectable ranges, 4.5 digit.
- UM-35-CL**Process 4 to 20mA (100.0), easily user scalable in engineering units from -1999 to +1999. 3.5 digit
- UM-35-HZ**15Hz to 199.9Hz or optional 40Hz to 400Hz up to 500V AC , 3.5 digit.
- UM-35-Pressure**.....Pressure, strain gage and load cell, 4 and 6 wire, 5V DC excitation, Header Selectable Sensitivity 2mV/V, 5mV/V, 10mV/V, 20mV/V, 3.5 digit
- UM-35-JF**.....J thermocouple input, 1° resolution, order °C or °F, 3.5 digit
- UM-35-KF**.....K thermocouple input, 1° resolution, order °C or °F, 3.5 digit
- UM-35-RTD/F**.....100Ω platinum RTD, 3 or 4 wire, order °C or °F and 0.1° or 1°, 3.5 digit
- UM-45-CL**Process 4 to 20mA (100.0), easily user scalable in engineering units from -19999 to +19999. 4.5 digit

Calibration Procedure

1. Apply a zero input by shorting the inputs to the meter. Adjust the zero trim pot until the meter reads 000.
2. Apply an AC voltage from 50V to 500V AC, of a known frequency.
3. Adjust the Span Pot until the meter displays the frequency being applied.
4. The UM-35-HZ is now calibrated and ready for use.

Decimal Point Selection

Decimal selection is made by moving the jumper to the indicated position on the header for the decimal required on the front of the display board.

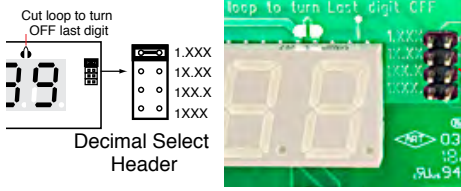

To open meter, insert a flat head screwdriver or similar instrument in both slots on the side of the cover and pry open. The UM-Series meters slide out from the front of the case as a complete assembly.

Signal Conditioning Components

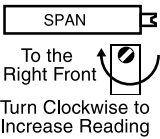

SPAN Potentiometer (Pot)

The 15 turn SPAN pot is always on the right side (as viewed from the front of the meter). Typical adjustment is 100% of the input signal range.

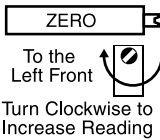

ZERO Potentiometer (Pot)

The Optional ZERO pot when installed is always to the left of the SPAN pot (as viewed from the front of the meter). Typically it enables the displayed reading to be offset ± 100 counts.

Optional Face Plate Descriptors

AC	12	kV	kVAH	m/hr	Hz	RPM
V	mV	mIn	PF	F	C	Cos ϕ
DC	$\times 10$ kN	μ A	PSIG	mS	kg/cm 2	DSt
kW	W	kWH	pH	%	K	kPa
A	mbar	mA	MW	KA	RPS	MWH
mWs	μ m	kW/s	l	l/sec	ml	cm
DRP	mm/s	l/min	mm	kg/sec	lbs	kg/hr
CT	bats	min	m/min	l/min	μ V	dB

To customize the face plate, clear adhesive label containing various popular descriptors may be ordered. Choose the descriptor desired, peel off the adhesive backing and align the descriptor in the center right of the faceplate.

P.N.: DU-CASEDES

Component Layout

Optional Isolated auto-sensing
AC/DC 9 to 36V DC / 12 to 24V AC
P.N.: V0-DC/ISO

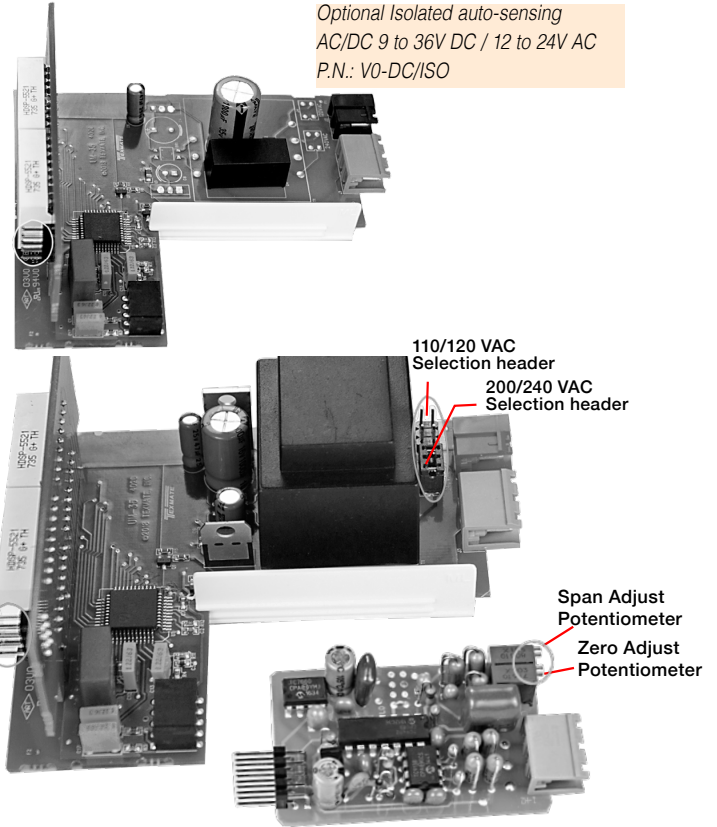

Connector Pinouts

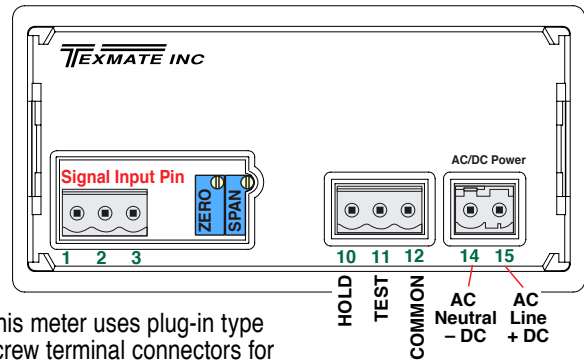

This meter uses plug-in type screw terminal connectors for all connections.

Connectors

This meter uses plug-in type screw terminal connectors for all input and output connections. The power supply connections (pins 14 and 15) have a unique plug and socket outline to prevent cross connection. The main board uses standard right-angled connectors.

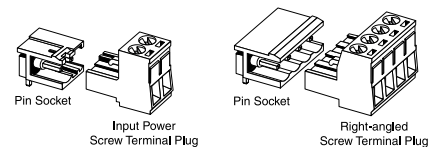

WARNING: AC and DC input signals and power supply voltages can be hazardous. Do Not connect live wires to screw terminal plugs, and do not insert, remove or handle screw terminal plugs with live wires connected.

UM Case Dimensions and Panel Cutouts

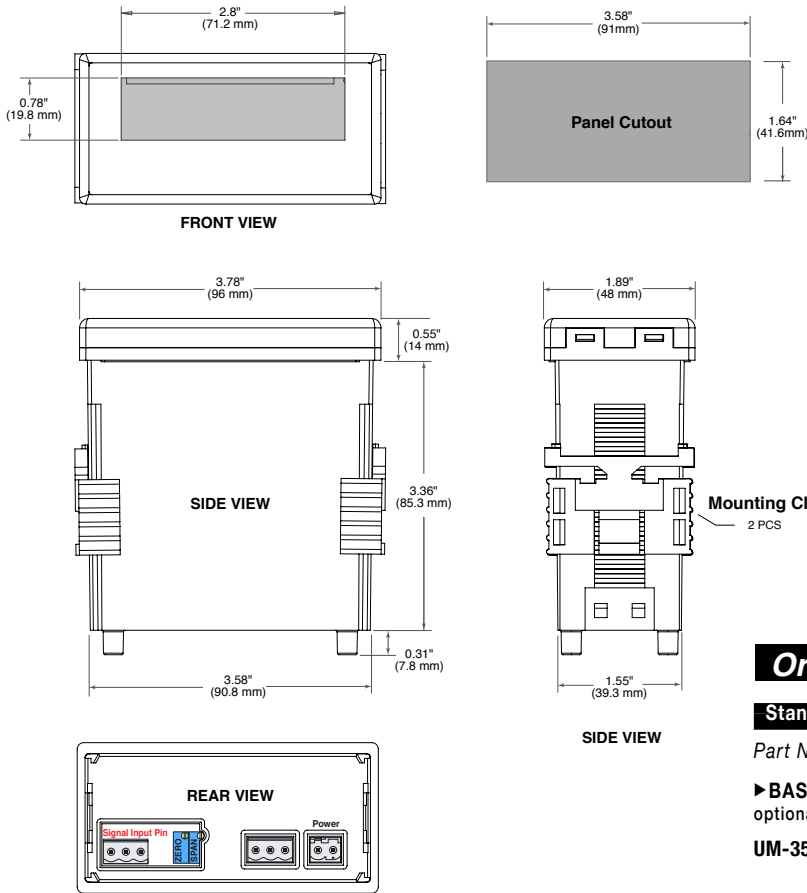

Clear Lockable Water-proof Cover

The clear lockable cover is designed to be dust and waterproof to NEMA-4X, IP65 standards. The assembly consists of a base and a cover with a cam hinge and key-lock fastening mechanism. An O-ring, or neoprene gasket forms a seal between the base and the panel. The cam hinge prevents the cover from closing when opened until pushed closed. The cover has a tapered recess that, when closed, forms a seal with a tapered spigot on the base. A key-lock employs a cam locking device to force the spigot into the recess, ensuring seal integrity. A safety catch keeps the cover closed even when the key is removed, and the keyhole can be used to attach a safety seal clip,

preventing unauthorized opening.

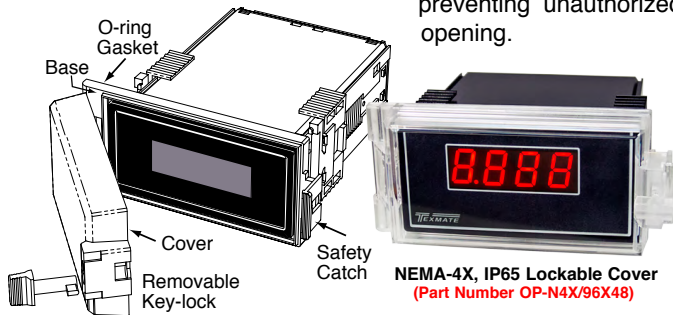

NEMA-4X, IP65 Lockable Cover
(Part Number OP-N4X/96X48)

TEXMATE Since 1976
Smart Measuring Smart Control
MADE IN U.S.A.

1934 Kellogg Ave., Carlsbad, CA 92008
Tel: 1-760-598-9899 • 1-800-TEXMATE
Fax: 1-760-598-9828 • Email: orders@texmate.com

Warranty and User's Responsibility

WARRANTY

Texmate warrants that its products are free from defects in material and workmanship under normal use and service for a period of one year from date of shipment. Texmate's obligations under this warranty are limited to replacement or repair, at its option, at its factory, of any of the products which shall, within the applicable period after shipment, be returned to Texmate's facility, transportation charges pre-paid, and which are, after examination, disclosed to the satisfaction of Texmate to be thus defective. The warranty shall not apply to any equipment which shall have been repaired or altered, except by Texmate, or which shall have been subjected to misuse, negligence, or accident. In no case shall Texmate's liability exceed the original purchase price. The aforementioned provisions do not extend the original warranty period of any product which has been either repaired or replaced by Texmate.

USER'S RESPONSIBILITY

We are pleased to offer suggestions on the use of our various products either by way of printed matter or through direct contact with our sales/application engineering staff. However, since we have no control over the use of our products once they are shipped, NO WARRANTY WHETHER OF MERCHANTABILITY, FITNESS FOR PURPOSE, OR OTHERWISE is made beyond the repair, replacement, or refund of purchase price at the sole discretion of Texmate. Users shall determine the suitability of the product for the intended application before using, and the users assume all risk and liability whatsoever in connection therewith, regardless of any of our suggestions or statements as to application or construction. In no event shall Texmate's liability, in law or otherwise, be in excess of the purchase price of the product.

Texmate cannot assume responsibility for any circuitry described. No circuit patent or software licenses are implied. Texmate reserves the right to change circuitry, operating software, specifications, and prices without notice at any time.

Ordering Information

Standard Options for this Model Number

Part Number Description

► **BASIC MODEL NUMBER** standard display and standard power supply unless optional versions are ordered.

UM-35-HZ AC Line Frequency, 15.0 to 199.9Hz. (IF02)
optional of 40Hz to 400Hz

► DISPLAY

DR **0.56" Red LEDs**

UM-BRIGHT Super bright Red LEDs, 0.56 inch high

UM-GREEN Green LEDs, 0.56 inch high

► POWER SUPPLY

PS6 **100/120 or 200/240VAC 60/50Hz User selectable**

PS7 Isolated auto-sensing AC/DC 9 to 36V DC/12 to 24V AC

Special Options and Accessories

Part Number Description

► SPECIAL OPTIONS (Specify Inputs & Req. Reading)

ZR Input Range Change to another Standard Range

ZRS-SMUM Non-standard range change and/or Scale change

► ACCESSORIES

OP-N4X/96X48 .96x48mm clear lockable front cover NEMA 4X, splash proof
CASE.RPUM. . . Case: Replacement with Accessories

ART-NRC-DEC .NRC for Artwork & set-up Custom Faceplate and/or Descriptor
ART-FS1 Produce & Install Custom Faceplate per meter - 1 color no-min
ART-FS2 Produce & Install Custom Faceplate per meter - 2 color no-min
ART-FS3 Produce & Install Custom Faceplate per meter - 3 color no-min
DU-CASEDES Clear adhesive descriptors label for face plate

Custom Face Plates

Texmate Produces Thousands of Custom OEM Face Plates.
Have Texmate Design and produce a Custom Face Plate for your next project!

• Custom face plates have a non-recurring artwork charge. A serial number is then assigned to each artwork to facilitate reordering.

UM-35-HZ Technical Manual Copyright © 2018 Texmate Inc. All rights reserved. Published by: Texmate Inc. USA. Information in this Technical Manual is subject to change without notice due to correction or enhancement. The information described in this manual is proprietary to Texmate, Inc. and may not be copied, reproduced or transmitted, in whole or in part, in connection with the design, manufacture, or sale of apparatus, device or private label product without the express written consent of Texmate, Inc.