



Optional super bright LEDs



Optional Green LED Display



UM-35-ACA

1/5 Amp AC True RMS

Utility AC current measuring meters designed for direct connection to industry standard 1 Amp and 5 Amp CTs.

3 1/2 DIGIT with 0.56" LEDs in a NEMA type 1 Style Case

General Features

The UM-35-ACA is cost-effective, utility AC current measuring meters. Their low resistance internal shunt, has a very low burden of 0.1VA and 0.5VA when directly connected to 1A or 5A CT's (current transformers) respectively. No matter what the CT ratio, the 15 turn, infinitely adjustable Span potentiometer enables the user to easily scale the meters to display almost any current value required.

The UM-35-ACA meters can withstand momentary over loads of up to 200 Amps (40 times input signal) for one second without developing an open circuit. Texmate's unique differential AC measurement circuit provides a safe high impedance ohmic isolation on both sides of the shunt.

Typical Application Connections

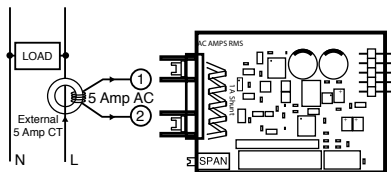

AC True RMS Current measurement in Single-phase Systems.
Easily User Scaled to Display Currents up to 1999 Amps.

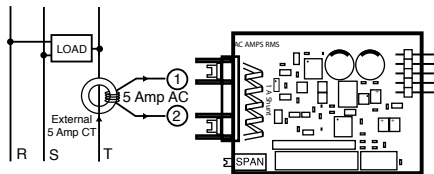

AC True RMS Current measurement in Multi-phase Systems.
Easily User Scaled to Display Currents up to 1999 Amps in 3 Phase 3 Wire and 3 Phase 4 Wire Systems.

Specifications

Input Configuration:.....Shunt input with differential auto zeroing AC to DC converter scaled in True RMS.

Full Scale Ranges:1 Amp and 5 Amp Inputs can be scaled to any desired display value from 0 to 1999.

Input Impedance:.....0.02Ω for 5A CT. Burden is only 0.5VA
0.1Ω for 1A CT. Burden is only 0.1VA

A/D Converter:.....12 Bit Dual Slope

Accuracy:.....±(0.05% of reading + 2 counts)

Temperature Coefficient: 100 ppm/°C (Typical)

Warm Up Time:.....2 minutes to specified accuracy

Conversion Rate:.....3 conversions per second (Typical)

Display:.....3 1/2 digit 0.56" Red LED display (std),
Green or Super Bright Red are optional.
Range 0 to 1999 counts.

Decimal Selection:Header under face plate, X·X·X·X·

Over-range Indication:1 (MSD) displayed all other digits blank

Power Supply (PS6 std):..Auto-sensing 85-305VAC or 120-430VDC,
50/60Hz App. 1W

(PS7 opt.) ..Isolated (1.5kV) auto-sensing 9-36 VDC 1W

(PS11 opt.) ..Isolated (1.5kV) auto-sensing 36-75 VDC 1W

(PS8 opt.) ..5VDC/200mA

Operating Temperature:...-10 to 50 °C

Storage Temperature:-20 to 70 °C.

Relative Humidity:95% (non-condensing)

Case Dimensions:Bezel 3.78"Wx1.89"H (96mm x 48mm)
Depth behind bezel 3.36" (83.5mm) Plus
0.5 to .9" (12.7 to 22.8mm) depending on
connector used.

Weight:NW. 12oz (0.34kg)

15.6oz (0.44kg). when packed.

UM-Series utility meters for switchboard and process indication

UM-35-ACAAC amps, True RMS, (1 or 5 Amp internal shunt), 3.5 digit.

UM-35-ACVAC volts, True RMS. 199.9V AC/700V AC header selectable ranges, 3.5 digit.

UM-35-DCADC mV ±20mV/±50mV/ ±100mV/±200mV header selectable ranges, 3.5 digit

UM-35-DCVDC Volts ±2V/±20V/±200V DC header selectable ranges, 3.5 digit.

UM-40-ACAAC amps, True RMS, (1 or 5 Amp internal shunt), 4.0 digit.

UM-40-ACVAC volts, True RMS. 199.9V AC/700V AC header selectable ranges,4.0 digit.

UM-45-DCADC mV ±20mV/±50mV/ ±100mV/±200mV header selectable ranges, 4.5 digit

UM-45-DCVDC Volts ±2V/±20V/±200V DC Header selectable ranges, 4.5 digit.

UM-35-CLProcess 4 to 20mA (100.0), easily user scalable in engineering units from
-1999 to +1999. 3.5 digit

UM-35-HZ15Hz to 199.9Hz or optional 40Hz to 400Hz up to 500V AC , 3.5 digit.

UM-35-SGPressure, strain gage and load cell, 4 and 6 wire, 5V DC excitation,
Header Selectable Sensitivity 2mV/V, 5mV/V, 10mV/V, 20mV/V, 3.5 digit

UM-35-JFJ thermocouple input, 1° resolution, order °C or °F, 3.5 digit

UM-35-KFK thermocouple input, 1° resolution, order °C or °F, 3.5 digit

UM-35-RTD100Ω platinum RTD, 3 or 4 wire, order °C or °F and 0.1° or 1°, 3.5 digit

UM-45-CLProcess 4 to 20mA (100.0), easily user scalable in engineering units from
-19999 to +19999. 4.5 digit

Calibration Procedure

1. Connect the secondary of the current transformer (CT) to the meter inputs, and apply a known current. For high current CTs, a known AC current, proportionate to the CT output, should be used for calibration.
2. Adjust the Span Pot until the meter displays the required reading for the current being applied.
3. The UM-35-ACA is now calibrated and ready for use.
(Whenever a new range is selected, re-calibration is required to meet the specified accuracy).

Decimal Point Selection

Decimal selection is made by moving the jumper to the indicated position on the header for the decimal required on the front of the display board.

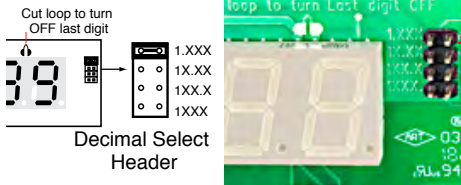

To open meter, insert a flat head screwdriver or similar instrument in both slots on the side of the cover and pry open. The UM-Series meters slide out from the front of the case as a complete assembly.

Component Layout

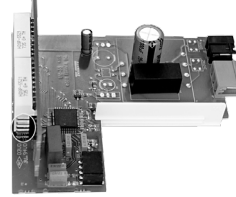

Optional Isolated Auto-sensing
9 to 36VDC (P.N.: PS7)
36 to 75VDC (P.N.: PS11)

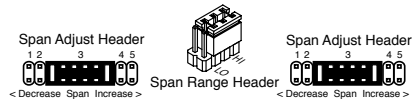
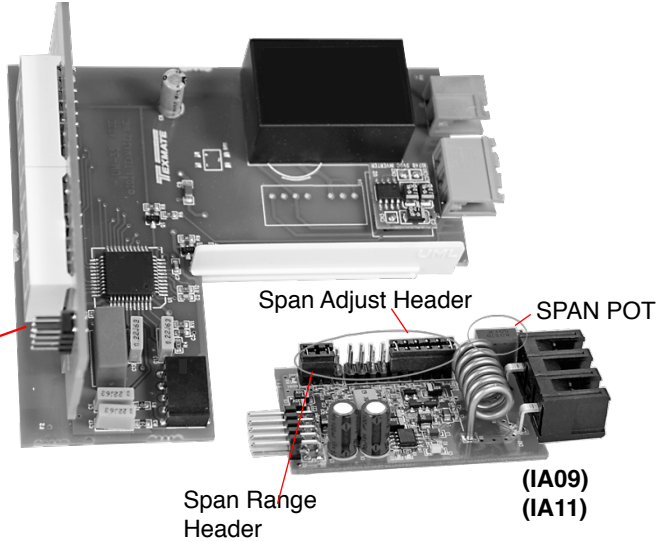

SPAN Adjust Header position	1	2	3	4	5	1	2	3	4	5
SPAN Pot %	10%	10%	10%	10%	10%	10%	10%	10%	10%	10%
Signal Span %	10%	20%	30%	40%	50%	60%	70%	80%	90%	100%

Connector Pinouts

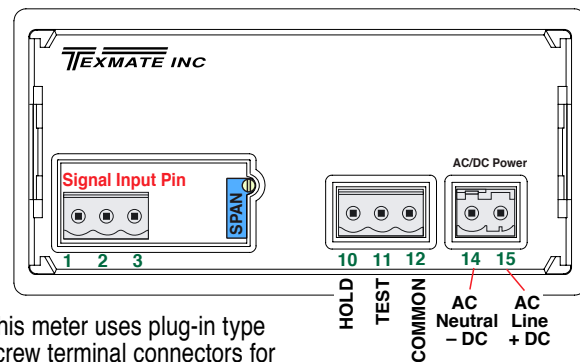

This meter uses plug-in type screw terminal connectors for all connections.

Connectors

This meter uses plug-in type screw terminal connectors for all input and output connections. The power supply connections (pins 14 and 15) have a unique plug and socket outline to prevent cross connection. The main board uses standard right-angled connectors.

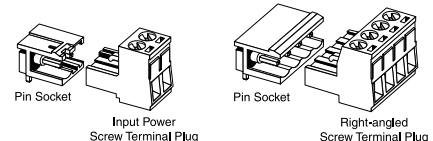

WARNING: AC and DC input signals and power supply voltages can be hazardous. Do Not connect live wires to screw terminal plugs, and do not insert, remove or handle screw terminal plugs with live wires connected.

Signal Conditioning Components

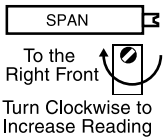

SPAN Potentiometer (Pot)

The 15 turn SPAN pot is always on the right side (as viewed from the front of the meter). Typical adjustment is 100% of the input signal range.

Optional Face Plate Descriptors

AC	V _{eff}	kV	kVAR	m/hr	Hz	RPM
V	mV	min	PF	F	G	Cosφ
DC	mA	μA	PSIG	mS	kg/cm ²	psi
kW	W	kWH	pH	%	K	kPa
A	mbar	mA	MW	kA	RPS	MWH
mWs	μm	kW/s	I	l/sec	ml	cm
ORP	mm/s	l/min	mm	kg/sec	lbs	g/ml
CT	bars	l/min	mm	kg/sec	μV	dB

To customize the face plate, clear adhesive label containing various popular descriptors may be ordered. Choose the descriptor desired, peel off the adhesive backing and align the descriptor in the center right of the faceplate.

P.N.: DU-CASEDES

UM Case Dimensions and Panel Cutouts

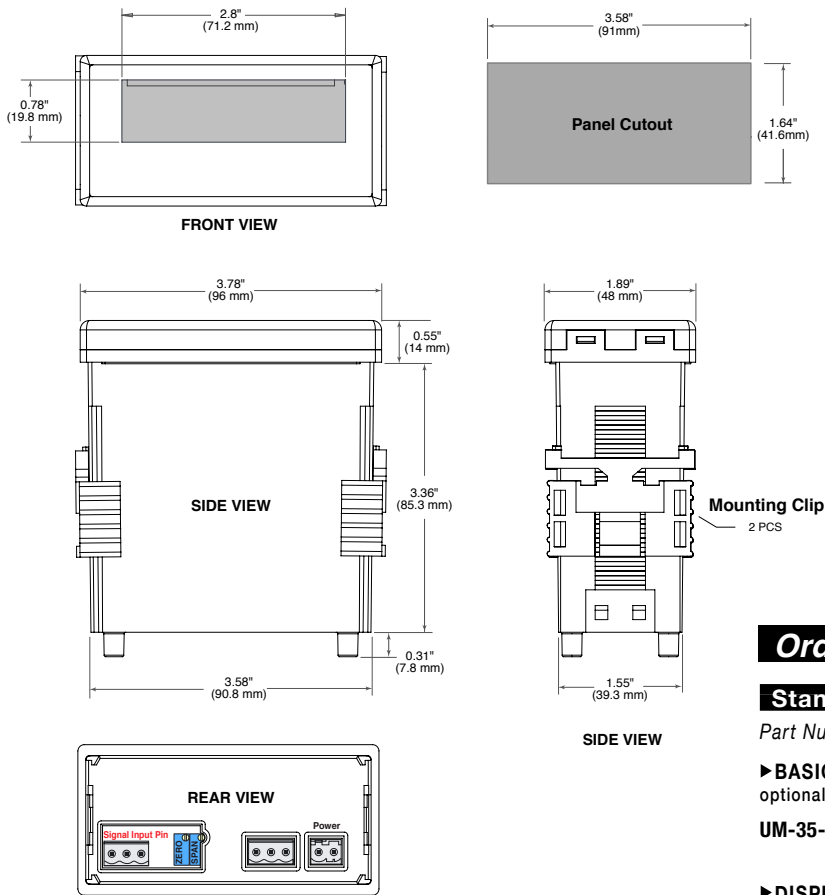

Clear Lockable Water-proof Cover

The clear lockable cover is designed to be dust and waterproof to NEMA-4X, IP65 standards. The assembly consists of a base and a cover with a cam hinge and key-lock fastening mechanism. An O-ring, or neoprene gasket forms a seal between the base and the panel. The cam hinge prevents the cover from closing when opened until pushed closed. The cover has a tapered recess that, when closed, forms a seal with a tapered spigot on the base. A key-lock employs a cam locking device to force the spigot into the recess, ensuring seal integrity. A safety catch keeps the cover closed even when the key is removed, and the keyhole can be used to attach a safety seal clip,

preventing unauthorized opening.

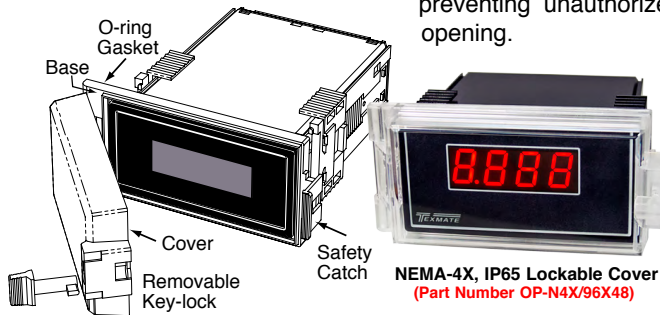

1934 Kellogg Ave., Carlsbad, CA 92008
Tel: 1-760-598-9899 • 1-800-TEXMATE • Email: orders@texmate.com

Warranty and User's Responsibility

WARRANTY

Texmate warrants that its products are free from defects in material and workmanship under normal use and service for a period of one year from date of shipment. Texmate's obligations under this warranty are limited to replacement or repair, at its option, at its factory, of any of the products which shall, within the applicable period after shipment, be returned to Texmate's facility, transportation charges pre-paid, and which are, after examination, disclosed to the satisfaction of Texmate to be thus defective. The warranty shall not apply to any equipment which shall have been repaired or altered, except by Texmate, or which shall have been subjected to misuse, negligence, or accident. In no case shall Texmate's liability exceed the original purchase price. The aforementioned provisions do not extend the original warranty period of any product which has been either repaired or replaced by Texmate.

USER'S RESPONSIBILITY

We are pleased to offer suggestions on the use of our various products either by way of printed matter or through direct contact with our sales/application engineering staff. However, since we have no control over the use of our products once they are shipped, NO WARRANTY WHETHER OF MERCHANTABILITY, FITNESS FOR PURPOSE, OR OTHERWISE is made beyond the repair, replacement, or refund of purchase price at the sole discretion of Texmate. Users shall determine the suitability of the product for the intended application before using, and the users assume all risk and liability whatsoever in connection therewith, regardless of any of our suggestions or statements as to application or construction. In no event shall Texmate's liability, in law or otherwise, be in excess of the purchase price of the product.

Texmate cannot assume responsibility for any circuitry described. No circuit patent or software licenses are implied. Texmate reserves the right to change circuitry, operating software, specifications, and prices without notice at any time.

Ordering Information

Standard Options for this Model Number

Part Number	Description
►BASIC MODEL NUMBER	tandard display and standard power supply unless optional versions are ordered.

UM-35-ACA..... AC amps, True RMS. (1 Amp or 5 Amp Internal shunt)
IA09(1 Amp) or IA11(5 Amp).....

►DISPLAY

DR.....0.56" Red LEDs
UM-BRIGHT.....Super bright Red LEDs, 0.56 inch high
UM-GREEN.....Green LEDs, 0.56 inch high

►POWER SUPPLY

PS6 (Std.).....85-305VAC or 120-430VDC, 50/60Hz, Approx.1W . . .
PS7.....Isolated (1.5kV) 9-36VDC Approx.1W
PS11.....Isolated (1.5kV) 36-75VDC Approx.1W
PS8.....5 VDC /200mA

Special Options and Accessories

Part Number	Description	List
-------------	-------------	------

►SPECIAL OPTIONS (Specify Inputs & Req. Reading)

ZR.....Input Range Change to another Standard Range
ZRS-SMUM.....Non-standard range change and/or Scale change

►ACCESSORIES

OP-N4X/96X48.96x48mm clear lockable front cover NEMA 4X, splash proof
CASE.RPUM. . .Case: Replacement with Accessories
ART-NRC-DEC.NRC for Artwork & set-up Custom Faceplate and/or Descriptor
ART-FS1Produce & Install Custom Faceplate per meter - 1 color no-min
ART-FS2Produce & Install Custom Faceplate per meter - 2 color no-min
ART-FS3Produce & Install Custom Faceplate per meter - 3 color no-min
DU-CASEDES.....Clear adhesive descriptors label for face plate

Custom Face Plates

Texmate Produces Thousands of Custom OEM Face Plates. Have Texmate Design and produce a Custom Face Plate for your next project!

• Custom face plates have a non-recurring artwork charge. A serial number is then assigned to each artwork to facilitate reordering.

UM-35-ACA Technical Manual Copyright © 2022 Texmate Inc. All rights reserved. Published by: Texmate Inc. USA. Information in this Technical Manual is subject to change without notice due to correction or enhancement. The information described in this manual is proprietary to Texmate, Inc. and may not be copied, reproduced or transmitted, in whole or in part, in connection with the design, manufacture, or sale of apparatus, device or private label product without the express written consent of Texmate, Inc.